The background of the cover is a dark, high-angle photograph of various industrial tools, including wrenches and sockets, arranged in a grid-like pattern within a tray. The lighting is dramatic, highlighting the metallic surfaces and the textures of the tools.

2012
INDUSTRIAL TOOLS
CATALOG

PROTO[®]



**“EVERY TOOL HAS A PURPOSE.
PUT FOOD ON MY TABLE.”**

WELCOME TO THE 2012 PROTO® CATALOG.

1200 pages of wrenches, pliers, ratchets, screwdrivers, hammers, chisels, sockets and more. All crafted for men and women who don't just pick up tools now and then, but rely on them 24, 7, 365.

PROTO®

»»»»»»»»»» **TABLE OF CONTENTS**

| | |
|---|------------------|
| The Proto® Brand | 0002-0013 |
| The Proto® Safety Program | 0014-0015 |
| Tool Storage | 0016-0055 |
| Custom Tool Kitting | 0055-0059 |
| Master Sets | 0060-0255 |
| Sockets, Drive Tools and Accessories | 0256-0443 |
| Impact and Power Sockets | 0444-0527 |
| Precision Torque | 0528-0553 |
| Wrenches | 0554-0665 |
| Screwdrivers, Nut Drivers and Hex Keys | 0666-0711 |
| Pliers, Clamping and Cutting | 0712-0753 |
| Striking and Struck | 0758-0777 |
| Pullers | 0778-0813 |
| Fleet Maintenance | 0814-0849 |
| Electrical Tools | 0850-0879 |
| Plumbing and HVAC Tools | 0880-0901 |
| Repair Kits | 0902-0905 |
| Stanley Hand Tools | 0906-1095 |
| Index | 1096-1189 |
| Conversion Charts | 1190-1199 |
| Warranties | 1200 |

You either show up ready to work or you don't. Proto® tools do. They work in the darkest depths

of mines, the corrosive salt air off-shore, the sand-blasted battlefields of the Middle East.

They do it with toughness and in ways that make the job faster, more efficient, more doable.

**“THERE IS NO ASTERISK
NEXT TO**

When a worker pulls a Proto® tool from a belt or box and heads into the roughest duties on the

planet, that worker knows he's not alone. And that when he comes back, the job will be done right.



RELIABLE.”

PROTO



**“YOU LEARN REAL QUICK TO REACH
FOR WHAT’S**

PROTO

Getting a job right day-in and day-out demands strength. The physical strength to endure back-breaking work and grueling hours. The mental strength to focus on the task at hand when arctic cold numbs your fingers or a mechanical break down has the factory floor in a panic. And sheer tool strength, tools that won't snap, bend or bust when called to duty.

STRONG.”

Proto® tools are heat forged and nickel-plated. They are tested to thousands of cycles.

And they are proven — having done the job you're asking of them for decades. Literally.

You wouldn't step foot onto a factory floor, shaft elevator or scissor lift without the proper

Personal Protective Equipment.

Proto® is just as safety obsessed. Our tools are crafted to exacting standards to

perform their duties. They incorporate ergonomically designed handles for firm grips. They include

features that prevent wrenches from slipping off fastener heads. And our breadth of line means

**“TOOLS ARE PPE. SAME AS
THE HAT ON**

you can match the right tool to the task. Moreover, our safety team travels the country providing

quality information on proper tool inspection, maintenance and use.

Proto® understands that a job done right ends at the family dinner table or the local

watering hole, not a hospital.



MY HEAD.”

PROTO

Proto® tools have been on the job for more than 100 years, proving their worth on the line,
under the ground and in the field.

The automobiles Henry Ford rolled off his line, the dams erected during the
Great Depression, the mines and oil rigs that fueled our country's economic might, and the
wind turbines spinning above the prairie — these were built by hands holding Proto® tools.

**“ GRANDDAD WENT TO WORK WITH THE SAME TOOLS I DO.
COURSE HE WALKED**

Those hands passed their tools on, right along with their tough-minded work ethic and determination
for building products that achieve, perform and endure. It's a heritage we proudly live up to with
every tool we sell.



UPHILL, BOTH WAYS. ”

PROTO



“LAST I CHECKED, MY JOB WAS

MADE IN

PROTO

Loyalty to American made, makes sense. The highest quality tools in the world are made by American hands and have been for more than a century. At least that's what we believe at Proto[®]. Which is why the vast majority of Proto[®] tools are still designed, forged, stamped, plated, polished, calibrated and crafted in the USA.

AMERICA.”

Yes, our tools can cost a bit more because of it. But they meet or exceed industry specifications.

Oh, and they put Americans to work. Like you.

PROTO®'S SAFETY OBSESSED TRAINING PROGRAM

Proto® Industrial Tools are among the safest available, thanks to innovative designs, high-quality materials, and precision manufacturing. However, even the best tools require regular inspection, maintenance, and proper use, which is why a growing number of companies are turning to Proto®'s Safety Obsessed Training Program to promote workplace safety.

The program includes an onsite seminar and accompanying DVD – available in English, Spanish and French – that presents the latest information on safe and responsible tool use for professionals who handle industrial tools. The program helps users identify when tools become worn or damaged and need to be replaced, as well as identifying specific tools and procedures that can improve site safety. Running as short as a half hour, the program can be customized to focus on specific safety concerns pertaining to your facility.

**“ MAKE THE RIGHT CHOICE.
SAFETY FIRST.”**

The video's concise and easy-to-follow segments include safety basics, sockets and drive tools, wrenches, screwdrivers, striking and struck tools, cutting tools, gear pullers and c-clamps, torque wrenches, and maintenance and storage. Each segment provides a refresher on the proper use of hand tools and general tool knowledge for that product category. The objective is to raise safety awareness and empower workers to identify potentially hazardous situations, offer safe alternatives, and minimize the chance of injuries.

For more information about the Proto® Safety Obsessed Training Program, please contact your Proto® representative.



EVERY TIME.
NO EXCUSES.

PROTO

SAFETY OBSESSED: A PROTO® SAFETY SEMINAR

Proto® has developed a hand tools safety seminar for presentation at company and industrial sites, focusing on tool safety awareness and what each worker can do to help keep themselves efficient and safe.

This seminar is available upon request to your Proto® representative and features a refresher course on core safety techniques and handling tips for hand tools in industrial environments.

The seminar can be customized to meet the individual safety needs of a specific site or company.

THE SEMINAR COVERS:

- › Hands-on demonstration of key tool categories.
- › Pointers for choosing the right tool for the job.
- › How to check tools for wear and damage.
- › Recommendations for workplace safety.
- › Examples of tool safety features.

“ A PROTO® SAFETY SEMINAR **SAFETY**

THE SEMINAR, PRESENTED BY PROTO® AT YOUR REQUEST, INCLUDES:

- › 18-minute safety video
- › PowerPoint presentation
- › Safety posters
- › Safety stickers
- › Hard hat stickers
- › Quiz and supporting materials
- › Certificate of completion

The Proto® Safety Obsessed Seminar can be expanded to include a Tool Safety Audit.



ONSITE SEMINAR WITH ACCOMPANYING DVD



POWERPOINT PRESENTATION AND CERTIFICATE OF COMPLETION

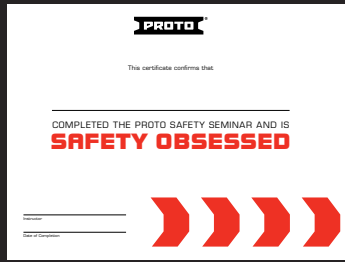

OBSESSED

SAFETY POSTERS AND STICKERS





PROTO

**WHEN YOUR FOREMAN SAYS TO GET YOUR
YOU-KNOW-WHAT TOGETHER, THIS IS WHAT HE MEANS.**

Because stationary or mobile, gigantic or small, Proto® tool boxes aren't just metal bins. They're icons of organization and efficiency. We're talking full extension drawers, sectionalized compartments and dozens of configurations. They're also built like a sledge with thick gauge steel housings, heavy steel drawer fronts, ball bearing slides and electrocoat finishes. Mobile units get beefed up further with diagonal reinforcing bars and shock absorbing wheels. It's everything you need to get squared away and stay that way, for a good, long time.



TOOL STORAGE



Heavy-Duty Utility Cart

PROTO



TOOL STORAGE ORGANIZED AROUND YOU

Proto® offers three series of tool storage solutions, from the versatile 440 series to the super-heavy-duty 460 series. All are built to exacting standards, include drawer liners, and have premium features like full-extension drawers, recessed drawer pulls, available built-in drawer compartments and durable finishes.

450 SERIES COLOR OPTIONS

Custom Colors Available by Request



TOOL BOX PRODUCT NUMBER IDENTIFICATION

Proto®'s item numbering system for tool boxes is designed to make it easy for users to identify the box that has the size and drawer configuration that best meets their needs.

EXAMPLE: J442742-4RD-D

Part Number Key

■ Series of Tool Box ■ Width and Height (inches) ■ # of Drawers ■ Cabinet Color ■ Special Feature

Special Feature Code

D = Drop Front IC = Intermediate Chest SC = Side Cabinet LK = Locker 1S = 1 Shelf 2S = 2 Shelf

460 SERIES — PREMIUM, HEAVY-DUTY STORAGE



All 460 series cabinets feature wood top work surfaces



Lock-in, lock-out drawers for security and safety



Drawer dividers make each drawer custom configurable

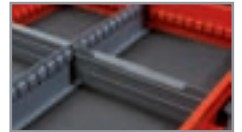

6" casters — 2 swivel, 2 rigid — load-rated to carry 800 lbs. per caster



Drawer capacity slides rated to 400 lbs.

450 SERIES — PREMIUM, INDUSTRIAL-DUTY STORAGE

Drawers extend fully and still carry 200 lbs



Dual ball bearing slides on deep drawers for added strength

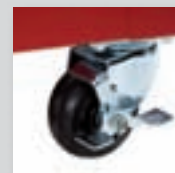

6"x 2" Phenolic casters are load-rated to carry 700 lbs. per caster

460 45" WORKSTATION - 10 DRAWER



| Product # | Color | Length In. | Height In. | Depth In. | Weight Lbs. |
|--------------|-------|------------|------------|-----------|-------------|
| J464542-10RD | Red | 45 | 42-1/2 | 21-3/8 | 400 |



| Quantity | Type | Length In. | Height In. | Depth In. |
|----------|--------|------------|------------|-----------|
| 1 | Drawer | 42-1/2 | 4-5/8 | 19-7/8 |
| 2 | Drawer | 20-1/4 | 3 | 19-7/8 |
| 1 | Drawer | 20-1/4 | 7 | 19-7/8 |
| 1 | Drawer | 20-1/4 | 12-1/2 | 19-7/8 |
| 1 | Drawer | 20-1/4 | 3-7/8 | 19-7/8 |
| 3 | Drawer | 20-1/4 | 4-5/8 | 19-7/8 |
| 1 | Drawer | 20-1/4 | 7-7/8 | 19-7/8 |

- › Premium tool storage line.
- › Cubic inch capacity is 24,457.
- › 22" depth footprint for high mobility.
- › All steel construction.
- › Heavy drawer capacity slides rated at 400 lbs.
- › Lock in / lock out drawers for security and safety.
- › Heavy load bearing casters – 800 lbs.
- › Built in compartments for customizable storage needs.
- › Heavy-duty 6" casters (2 swivel and 2 rigid).
- › Red powder coated finish.
- › Heavy-duty tubular lock system.
- › Vinyl top and drawer liners included.

460 45" WORKSTATION - 6 DRAWER



| Product # | Color | Length In. | Height In. | Depth In. | Weight Lbs. |
|----------------|-------|------------|------------|-----------|-------------|
| J464542-6RD-1S | Red | 45 | 42-1/2 | 21-3/8 | 390 |



| Qty. | Type | Length In. | Height In. | Depth In. |
|------|-------------|------------|------------|-----------|
| 1 | Drawer | 42-1/2 | 4-5/8 | 19-7/8 |
| 1 | Drawer | 20-1/4 | 3-7/8 | 19-7/8 |
| 3 | Drawer | 20-1/4 | 4-5/8 | 19-7/8 |
| 1 | Drawer | 20-1/4 | 7-7/8 | 19-7/8 |
| 1 | Compartment | 20-1/4 | 21-1/2 | 19-7/8 |

- › Premium tool storage line.
- › Cubic inch capacity is 24,498.
- › 22" depth footprint for high mobility.
- › All steel construction.
- › Heavy drawer capacity slides rated at 400 lbs.
- › Lock in / lock out drawers for security and safety.
- › Heavy load bearing casters – 800 lbs.
- › Built in compartments for customizable storage needs.
- › Heavy-duty 6" casters (2 swivel and 2 rigid).
- › Red powder coated finish.
- › Heavy-duty tubular lock system.
- › Vinyl top and drawer liners included.



460 30" ROLLER CABINET - 6 DRAWER



| Product # | Color | Length In. | Height In. | Depth In. | Weight Lbs. |
|-------------|-------|------------|------------|-----------|-------------|
| J463042-GRD | Red | 30 | 42-1/2 | 21-3/8 | 354 |



| Qty. | Type | Length In. | Height In. | Depth In. |
|------|--------|------------|------------|-----------|
| 1 | Drawer | 42-1/2 | 3 | 19-7/8 |
| 2 | Drawer | 20-1/4 | 3-7/8 | 19-7/8 |
| 1 | Drawer | 20-1/4 | 4-5/8 | 19-7/8 |
| 1 | Drawer | 20-1/4 | 6-1/4 | 19-7/8 |
| 1 | Drawer | 20-1/4 | 9-3/8 | 19-7/8 |

- › Premium tool storage line.
- › Cubic inch capacity is 15,965.
- › 22" depth footprint for high mobility.
- › All steel construction.
- › Heavy drawer capacity slides rated at 400 lbs.
- › Lock in / lock out drawers for security and safety.
- › Heavy load bearing casters – 800 lbs.
- › Built in compartments for customizable storage needs.
- › Heavy-duty 6" casters (2 swivel and 2 rigid).
- › Red powder coated finish.
- › Heavy-duty tubular lock system.
- › Vinyl top and drawer liners included.



THE STORY BEHIND THE 460 SERIES WORKSTATIONS

The 460 Series workstations are not so much a tool box as they are a mobile version of industrial storage. Everything from the drawers to the chests to the cabinets has been beefed up to handle bigger and heavier loads.

Designed by our engineers who specialize in permanent storage cabinets, the 460 workstation combines the strength and capacity of built-in storage with the flexibility and speed of a mobile unit.

LOCK-IN / LOCK-OUT DRAWERS

Drawers have a lift lever that not only makes tray movement easier when fully loaded; but the drawers also have a lock/lift that set the drawer down into a locked position each time it closes. That way, when you roll the cabinet, the drawers stay shut.

HEAVIER LOAD CAPACITY

You can safely move larger tool loads around the workshop when the drawers hold 400 lbs. of weight instead of 200 lbs.

Casters are also stronger - they can hold 800 lbs. of weight.

BETTER TOOL ORGANIZATION

Each drawer is built with customized storage dividers already included. This feature keeps tools neat and organized, as well as preventing items from rolling and mixing as the workstation is moved.



Many kinds of storage dividers to organize tools.

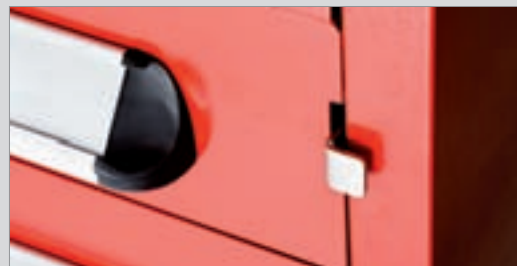

Lock and Lift Drawer System secures heavy loads tightly, but keep drawer movement smooth and easy.

450HS 67" WORKSTATION - 20 DRAWER



| Product # | Color | Length In. | Height In. | Depth In. | Weight Lbs. |
|--------------|-------|------------|------------|-----------|-------------|
| J456741-20RD | Red | 66-7/8 | 41 | 25-1/4 | 600 |



| Sizes | Qty. | Length In. | Height In. | Depth In. |
|---------------|----------|------------|------------|-----------|
| X-WIDE | 1 | 44-7/16 | 4-1/2 | 23 |
| WIDE | 2 | 28 | 2-1/4 | 23 |
| | 2 | 28 | 3-3/8 | 23 |
| | 1 | 28 | 4-1/2 | 23 |
| | 1 | 28 | 6-7/8 | 23 |
| NARROW | 5 | 13-7/16 | 2-1/4 | 23 |
| | 4 | 13-7/16 | 3-3/8 | 23 |
| | 3 | 13-7/16 | 4-1/2 | 23 |
| | 1 | 13-7/16 | 11-1/2 | 23 |

- › Storage capacity 30,519 cubic inches.
- › Large top drawer for socket storage.
- › Tubular lock for added security.
- › Full length aluminum drawer pulls.
- › 6"x2" Heavy-Duty casters with 1200-lbs. capacity per wheel.
- › Ball bearing track slides.
 - 125-lbs. capacity (250-lbs. for drawers with 2 sets of slides)
 - Adjustable detents 12 to 24-lbs. pull force
- › Interchangeable drawers can be moved to meet customer's needs.
- › Vinyl top and drawer liners included.

450HS 66" WORKSTATION - 12 DRAWER



| Product # | Color | Length In. | Height In. | Depth In. | Weight Lbs. |
|--------------|--------|------------|------------|-----------|-------------|
| J456646-12RD | Red | 66-1/2 | 46 | 27 | 750 |
| J456646-12BK | Black | 66-1/2 | 46 | 27 | 750 |
| J456646-12BL | Blue | 66-1/2 | 46 | 27 | 750 |
| J456646-12YL | Yellow | 66-1/2 | 46 | 27 | 750 |



| Quantity | Type | Length In. | Height In. | Depth In. |
|----------|--------|------------|------------|-----------|
| 1 | Drawer | 59 | 6 | 24-3/4 |
| 2 | Drawer | 37-3/8 | 1-3/4 | 24-3/4 |
| 2 | Drawer | 37-3/8 | 3 | 24-3/4 |
| 1 | Drawer | 37-3/8 | 4 | 24-3/4 |
| 1 | Drawer | 37-3/8 | 6 | 24-3/4 |
| 2 | Drawer | 18-2/3 | 1-3/4 | 24-3/4 |
| 2 | Drawer | 18-2/3 | 3 | 24-3/4 |
| 1 | Drawer | 18-2/3 | 11 | 24-3/4 |

- › Cubic inch capacity is 36,455.
- › Made of 14, 16 and 18 gauge steel.
- › Maximum weight capacity for each drawer is 200 lbs.
- › Standard red powder coat paint finish. Also available in black, blue and yellow, made to order. Contact customer service for availability.
- › Heavy-duty locks with tubular key.
- › Recessed aluminum extruded drawer pulls.
- › 100% full extension drawers.
- › Vinyl top and drawer liners included.
- › 6" x 2" Poly casters - 700 lbs./caster.



450HS 66" WORKSTATION - 11 DRAWER



| Product # | Color | Length In. | Height In. | Depth In. | Weight Lbs. |
|--------------|--------|------------|------------|-----------|-------------|
| J456646-11RD | Red | 66-1/2 | 46 | 27 | 750 |
| J456646-11BK | Black | 66-1/2 | 46 | 27 | 750 |
| J456646-11BL | Blue | 66-1/2 | 46 | 27 | 750 |
| J456646-11YL | Yellow | 66-1/2 | 46 | 27 | 750 |



| Quantity | Type | Length In. | Height In. | Depth In. |
|----------|--------|------------|------------|-----------|
| 1 | Drawer | 59 | 6 | 24-3/4 |
| 2 | Drawer | 37-3/8 | 3 | 24-3/4 |
| 2 | Drawer | 37-3/8 | 4 | 24-3/4 |
| 1 | Drawer | 37-3/8 | 6 | 24-3/4 |
| 2 | Drawer | 18-2/3 | 1-3/4 | 24-3/4 |
| 2 | Drawer | 18-2/3 | 3 | 24-3/4 |
| 1 | Drawer | 18-2/3 | 18 | 24-3/4 |

- › Cubic inch capacity is 35,917.
- › Made of 14, 16 and 18 gauge steel.
- › Maximum weight capacity for each drawer is 200 lbs.
- › Standard red powder coat paint finish. Also available in black, blue and yellow, made to order. Contact customer service for availability.
- › Heavy-duty locks with tubular key.
- › Recessed aluminum extruded drawer pulls.
- › 100% full extension drawers.
- › Vinyl top and drawer liners included.
- › 6" x 2" Poly casters - 700 lbs./caster.

450HS 57" WORKSTATION - 13 DRAWER



| Product # | Color | Length In. | Height In. | Depth In. | Weight lbs. |
|--------------|--------|------------|------------|-----------|-------------|
| J455743-13RD | Red | 57 | 43 | 25 | 625 |
| J455743-13BK | Black | 57 | 43 | 25 | 625 |
| J455743-13BL | Blue | 57 | 43 | 25 | 625 |
| J455743-13YL | Yellow | 57 | 43 | 25 | 625 |



| Quantity | Type | Length In. | Height In. | Depth In. |
|----------|--------|------------|------------|-----------|
| 3 | Drawer | 28 | 1-3/4 | 23 |
| 2 | Drawer | 28 | 3 | 23 |
| 1 | Drawer | 28 | 4 | 23 |
| 1 | Drawer | 28 | 6-3/8 | 23 |
| 2 | Drawer | 18-2/3 | 1-3/4 | 23 |
| 2 | Drawer | 18-2/3 | 4 | 23 |
| 1 | Drawer | 18-2/3 | 11 | 23 |
| 1 | Drawer | 49-2/3 | 3-7/8 | 23 |

- › Cubic inch capacity is 28,291.
- › Made of 14, 16 and 18 gauge steel.
- › Maximum weight capacity for each drawer is 200 lbs.
- › Standard red powder coat paint finish. Also available in black, blue and yellow, made to order. Contact customer service for availability.
- › Heavy-duty locks with tubular key.
- › Recessed aluminum extruded drawer pulls.
- › 100% full extension drawers.
- › Vinyl top and drawer liners included.
- › 6" x 2" Poly casters - 700 lbs./caster.



450HS 57" WORKSTATION - 11 DRAWER



| Product # | Color | Length In. | Height In. | Depth In. | Weight Lbs. |
|--------------|--------|------------|------------|-----------|-------------|
| J455743-11RD | Red | 57 | 43 | 25 | 625 |
| J455743-11BK | Black | 57 | 43 | 25 | 625 |
| J455743-11BL | Blue | 57 | 43 | 25 | 625 |
| J455743-11YL | Yellow | 57 | 43 | 25 | 625 |



| Quantity | Type | Length In. | Height In. | Depth In. |
|----------|--------|------------|------------|-----------|
| 1 | Drawer | 28 | 4 | 23 |
| 3 | Drawer | 28 | 6-3/8 | 23 |
| 1 | Drawer | 18-2/3 | 1-3/4 | 23 |
| 5 | Drawer | 18-2/3 | 4 | 23 |
| 1 | Drawer | 49-2/3 | 3-7/8 | 23 |

- › Cubic inch capacity is 26,541.
- › Made of 14, 16 and 18 gauge steel.
- › Maximum weight capacity for each drawer is 200 lbs.
- › Standard red powder coat paint finish. Also available in black, blue and yellow, made to order. Contact customer service for availability.
- › Heavy-duty locks with tubular key.
- › Recessed aluminum extruded drawer pulls.
- › 100% full extension drawers.
- › Vinyl top and drawer liners included.
- › 6" x 2" Poly casters - 700 lbs./caster.

450HS 50" WORKSTATION - 8 DRAWER - 2 SHELVES



| Product # | Color | Length In. | Height In. | Depth In. | Weight Lbs. |
|----------------|--------|------------|------------|-----------|-------------|
| J455041-8RD-2S | Red | 50-1/2 | 41 | 25 | 475 |
| J455041-8BK-2S | Black | 50-1/2 | 41 | 25 | 475 |
| J455041-8BL-2S | Blue | 50-1/2 | 41 | 25 | 475 |
| J455041-8YL-2S | Yellow | 50-1/2 | 41 | 25 | 475 |



| Quantity | Type | Length In. | Height In. | Depth In. |
|----------|--------|------------|------------|-----------|
| 4 | Drawer | 28 | 1-3/4 | 23 |
| 3 | Drawer | 28 | 4 | 23 |
| 1 | Drawer | 44-7/16 | 4 | 23 |
| 2 | Bin | 13-7/16 | 18 | 23 |

- › Cubic inch capacity is 18,920.
- › Made of 14, 16 and 18 gauge steel.
- › Maximum weight capacity for each drawer is 125 lbs.
- › Standard red powder coat paint finish. Also available in black, blue and yellow, made to order. Contact customer service for availability.
- › Heavy-duty locks with tubular key.
- › Recessed aluminum extruded drawer pulls.
- › 100% full extension drawers.
- › Vinyl top and drawer liners included.
- › 6" x 2" Poly casters - 700 lbs./caster.



450HS 50" WORKSTATION - 8 DRAWER - 1 SHELF



| Product # | Color | Length In. | Height In. | Depth In. | Weight Lbs. |
|----------------|--------|------------|------------|-----------|-------------|
| J455041-8RD-1S | Red | 50-1/2 | 41 | 25 | 475 |
| J455041-8BK-1S | Black | 50-1/2 | 41 | 25 | 475 |
| J455041-8BL-1S | Blue | 50-1/2 | 41 | 25 | 475 |
| J455041-8YL-1S | Yellow | 50-1/2 | 41 | 25 | 475 |



| Quantity | Type | Length In. | Height In. | Depth In. |
|----------|--------|------------|------------|-----------|
| 4 | Drawer | 28 | 1-3/4 | 23 |
| 3 | Drawer | 28 | 4 | 23 |
| 1 | Drawer | 44-7/16 | 4 | 23 |
| 1 | Bin | 13-7/16 | 18 | 23 |

- › Cubic inch capacity is 20,092.
- › Made of 14, 16 and 18 gauge steel.
- › Maximum weight capacity for each drawer is 125 lbs.
- › Standard red powder coat paint finish. Also available in black, blue and yellow, made to order. Contact customer service for availability.
- › Heavy-duty locks with tubular key.
- › Recessed aluminum extruded drawer pulls.
- › 100% full extension drawers.
- › Vinyl top and drawer liners included.
- › 6" x 2" Poly casters - 700 lbs./caster.

450HS 50" WORKSTATION - 7 DRAWER - 1 SHELF



| Product # | Color | Length In. | Height In. | Depth In. | Weight Lbs. |
|----------------|--------|------------|------------|-----------|-------------|
| J455041-7RD-1S | Red | 50-1/2 | 41 | 25 | 475 |
| J455041-7BK-1S | Black | 50-1/2 | 41 | 25 | 475 |
| J455041-7BL-1S | Blue | 50-1/2 | 41 | 25 | 475 |
| J455041-7YL-1S | Yellow | 50-1/2 | 41 | 25 | 475 |



| Quantity | Type | Length In. | Height In. | Depth In. |
|----------|--------|------------|------------|-----------|
| 1 | Drawer | 28 | 1-3/4 | 23 |
| 2 | Drawer | 28 | 3 | 23 |
| 3 | Drawer | 28 | 4 | 23 |
| 1 | Drawer | 44-7/16 | 4 | 23 |
| 1 | Bin | 13-7/16 | 18 | 23 |

- › Cubic inch capacity is 18,109.
- › Made of 14, 16 and 18 gauge steel.
- › Maximum weight capacity for each drawer is 125 lbs.
- › Standard red powder coat paint finish. Also available in black, blue and yellow, made to order. Contact customer service for availability.
- › Heavy-duty locks with tubular key.
- › Recessed aluminum extruded drawer pulls.
- › 100% full extension drawers.
- › Vinyl top and drawer liners included.
- › 6" x 2" Poly casters - 700 lbs./caster.

450HS 50" WORKSTATION - 12 DRAWER



| Product # | Color | Length In. | Height In. | Depth In. | Weight lbs. |
|--------------|--------|------------|------------|-----------|-------------|
| J455041-12RD | Red | 50-1/2 | 41 | 25 | 475 |
| J455041-12BK | Black | 50-1/2 | 41 | 25 | 475 |
| J455041-12BL | Blue | 50-1/2 | 41 | 25 | 475 |
| J455041-12YL | Yellow | 50-1/2 | 41 | 25 | 475 |



| Quantity | Type | Length In. | Height In. | Depth In. |
|----------|--------|------------|------------|-----------|
| 1 | Drawer | 28 | 1-3/4 | 23 |
| 3 | Drawer | 28 | 4 | 23 |
| 1 | Drawer | 28 | 6-7/16 | 23 |
| 1 | Drawer | 13-7/16 | 1-3/4 | 23 |
| 2 | Drawer | 13-7/16 | 3 | 23 |
| 3 | Drawer | 13-7/16 | 4 | 23 |
| 1 | Drawer | 44-7/16 | 4 | 23 |

- › Cubic inch capacity is 23,419.
- › Made of 14, 16 and 18 gauge steel.
- › Maximum weight capacity for each drawer is 125 lbs.
- › Standard red powder coat paint finish. Also available in black, blue and yellow, made to order. Contact customer service for availability.
- › Heavy-duty locks with tubular key.
- › Recessed aluminum extruded drawer pulls.
- › 100% full extension drawers.
- › Vinyl top and drawer liners included.
- › 6" x 2" Poly casters - 700 lbs./caster.

450HS 50" WORKSTATION - 10 DRAWER



| Product # | Color | Length In. | Height In. | Depth In. | Weight lbs. |
|--------------|--------|------------|------------|-----------|-------------|
| J455041-10RD | Red | 50-1/2 | 41 | 25 | 475 |
| J455041-10BK | Black | 50-1/2 | 41 | 25 | 475 |
| J455041-10BL | Blue | 50-1/2 | 41 | 25 | 475 |
| J455041-10YL | Yellow | 50-1/2 | 41 | 25 | 475 |



| Quantity | Type | Length In. | Height In. | Depth In. |
|----------|--------|------------|------------|-----------|
| 1 | Drawer | 28 | 1-3/4 | 23 |
| 3 | Drawer | 28 | 4 | 23 |
| 1 | Drawer | 28 | 6-7/16 | 23 |
| 1 | Drawer | 13-7/16 | 1-3/4 | 23 |
| 2 | Drawer | 13-7/16 | 4 | 23 |
| 1 | Drawer | 13-7/16 | 11 | 23 |
| 1 | Drawer | 44-7/16 | 4 | 23 |

- › Cubic inch capacity is 23,779.
- › Made of 14, 16 and 18 gauge steel.
- › Maximum weight capacity for each drawer is 125 lbs.
- › Standard red powder coat paint finish. Also available in black, blue and yellow, made to order. Contact customer service for availability.
- › Heavy-duty locks with tubular key.
- › Recessed aluminum extruded drawer pulls.
- › 100% full extension drawers.
- › Vinyl top and drawer liners included.
- › 6" x 2" Poly casters - 700 lbs./caster.



450HS 34" ROLLER CABINET - 8 DRAWER



| Product # | Color | Length In. | Height In. | Depth In. | Weight Lbs. |
|-------------|--------|------------|------------|-----------|-------------|
| J453441-8RD | Red | 34 | 41 | 25 | 310 |
| J453441-8BK | Black | 34 | 41 | 25 | 310 |
| J453441-8BL | Blue | 34 | 41 | 25 | 310 |
| J453441-8YL | Yellow | 34 | 41 | 25 | 310 |



| Quantity | Type | Length In. | Height In. | Depth In. |
|----------|--------|------------|------------|-----------|
| 4 | Drawer | 28 | 1-3/4 | 23 |
| 1 | Drawer | 28 | 4 | 23 |
| 2 | Drawer | 28 | 3 | 23 |
| 1 | Drawer | 28 | 6-1/2 | 23 |

- › Cubic inch capacity is 15,134.
- › Made of 14, 16 and 18 gauge steel.
- › Maximum weight capacity for each drawer is 125 lbs.
- › Standard red powder coat paint finish. Also available in black, blue and yellow, made to order. Contact customer service for availability.
- › Heavy-duty locks with tubular key.
- › Recessed aluminum extruded drawer pulls.
- › 100% full extension drawers.
- › Vinyl top and drawer liners included.
- › 6" x 2" Poly casters - 700 lbs./caster.

450HS 34" ROLLER CABINET - 7 DRAWER



| Product # | Color | Length In. | Height In. | Depth In. | Weight Lbs. |
|-------------|--------|------------|------------|-----------|-------------|
| J453441-7RD | Red | 34 | 41 | 25 | 310 |
| J453441-7BK | Black | 34 | 41 | 25 | 310 |
| J453441-7BL | Blue | 34 | 41 | 25 | 310 |
| J453441-7YL | Yellow | 34 | 41 | 25 | 310 |



| Quantity | Type | Length In. | Height In. | Depth In. |
|----------|--------|------------|------------|-----------|
| 3 | Drawer | 28 | 1-3/4 | 23 |
| 2 | Drawer | 28 | 4 | 23 |
| 2 | Drawer | 28 | 6-1/2 | 23 |

- › Cubic inch capacity is 15,390.
- › Made of 14, 16 and 18 gauge steel.
- › Maximum weight capacity for each drawer is 125 lbs.
- › Standard red powder coat paint finish. Also available in black, blue and yellow, made to order. Contact customer service for availability.
- › Heavy-duty locks with tubular key.
- › Recessed aluminum extruded drawer pulls.
- › 100% full extension drawers.
- › Vinyl top and drawer liners included.
- › 6" x 2" Poly casters - 700 lbs./caster.



450HS 34" ROLLER CABINET - 6 DRAWER



| Product # | Color | Length In. | Height In. | Depth In. | Weight Lbs. |
|-------------|--------|------------|------------|-----------|-------------|
| J453441-6RD | Red | 34 | 41 | 25 | 310 |
| J453441-6BK | Black | 34 | 41 | 25 | 310 |
| J453441-6BL | Blue | 34 | 41 | 25 | 310 |
| J453441-6YL | Yellow | 34 | 41 | 25 | 310 |



| Quantity | Type | Length In. | Height In. | Depth In. |
|----------|--------|------------|------------|-----------|
| 2 | Drawer | 28 | 1-3/4 | 23 |
| 2 | Drawer | 28 | 4 | 23 |
| 2 | Drawer | 28 | 6-1/2 | 23 |

- › Cubic inch capacity is 15,765.
- › Made of 14, 16 and 18 gauge steel.
- › Maximum weight capacity for each drawer is 125 lbs.
- › Standard red powder coat paint finish. Also available in black, blue and yellow, made to order. Contact customer service for availability.
- › Heavy-duty locks with tubular key.
- › Recessed aluminum extruded drawer pulls.
- › 100% full extension drawers.
- › Vinyl top and drawer liners included.
- › 6" x 2" Poly casters - 700 lbs./caster.

HEAVY-DUTY UTILITY CARTS



| Product # | Color | Length In. | Height In. | Depth In. | Weight Lbs. |
|-------------|--------|------------|------------|-----------|-------------|
| J459000-3RD | Red | 39-1/2 | 46 | 23 | 350 |
| J459000-3BK | Black | 39-1/2 | 46 | 23 | 350 |
| J459000-3BL | Blue | 39-1/2 | 46 | 23 | 350 |
| J459000-3YL | Yellow | 39-1/2 | 46 | 23 | 350 |



| Quantity | Type | Length In. | Height In. | Depth In. |
|----------|-------------|------------|------------|-----------|
| 2 | Drawer | 28-5/8 | 2-7/8 | 18-3/8 |
| 1 | Drawer | 28-5/8 | 5-7/16 | 18-3/8 |
| 1 | Compartment | 31-1/4 | 5-7/16 | 17-1/2 |

- › Proto® Utility Carts have been developed to meet the increasing requirements that customers demand.
- › Cubic inch capacity is 25,450.
- › 36-1/2" x 21-1/2" top work surface with vinyl mat.
- › Oil filled shock lift top.
- › Single barrel lock.
- › Retractable lift lid opens to a 5" storage compartment with side and back storage for long handled items.
- › Three drawers for storage.
 - Two: 2-3/4" drawers. One: 6" drawer.
 - 100 lbs. ball bearing slides.
 - Dual ball bearing slides on 6" drawer only.
- › Open storage area.
- › Outside and inside extension / pry bar storage area.
- › 5" x 2" Casters. 2 rigid, 2 swivel.
- › Vinyl top and drawer liners included.



450HS 66" TOP CHEST - 10 DRAWER



| Product # | Color | Length In. | Height In. | Depth In. | Weight lbs. |
|--------------|--------|------------|------------|-----------|-------------|
| J456627-10RD | Red | 66 | 27-1/4 | 27 | 550 |
| J456627-10BK | Black | 66 | 27-1/4 | 27 | 550 |
| J456627-10BL | Blue | 66 | 27-1/4 | 27 | 550 |
| J456627-10YL | Yellow | 66 | 27-1/4 | 27 | 550 |



| Quantity | Type | Length In. | Height In. | Depth In. |
|----------|-------------|------------|------------|-----------|
| 3 | Drawer | 37-3/8 | 2-1/4 | 24-3/4 |
| 2 | Drawer | 37-3/8 | 3-3/8 | 24-3/4 |
| 3 | Drawer | 18-5/8 | 2-1/4 | 24-3/4 |
| 2 | Drawer | 18-5/8 | 3-3/8 | 24-3/4 |
| 1 | Compartment | 58 | 6-7/16 | 24-3/4 |

- › Cubic inch capacity is 26,684.
- › Made of 14, 16 and 18 gauge steel.
- › Maximum weight capacity for each drawer is 200 lbs.
- › Standard red powder coat paint finish. Also available in black, blue and yellow, made to order. Contact customer service for availability.
- › Heavy-duty locks with tubular key.
- › Recessed aluminum extruded drawer pulls.
- › 100% full extension drawers.
- › Vinyl top and drawer liners included.

450HS 66" TOP CHEST - 8 DRAWER



| Product # | Color | Length In. | Height In. | Depth In. | Weight Lbs. |
|-------------|--------|------------|------------|-----------|-------------|
| J456627-8RD | Red | 66 | 27-1/4 | 27 | 550 |
| J456627-8BK | Black | 66 | 27-1/4 | 27 | 550 |
| J456627-8BL | Blue | 66 | 27-1/4 | 27 | 550 |
| J456627-8YL | Yellow | 66 | 27-1/4 | 27 | 550 |



| Quantity | Type | Length In. | Height In. | Depth In. |
|----------|-------------|------------|------------|-----------|
| 1 | Drawer | 37-3/8 | 2-1/4 | 24-3/4 |
| 2 | Drawer | 37-3/8 | 3-3/8 | 24-3/4 |
| 1 | Drawer | 37-3/8 | 2-1/4 | 24-3/4 |
| 4 | Drawer | 18-5/8 | 3-3/8 | 24-3/4 |
| 1 | Compartment | 58 | 6-7/16 | 24-3/4 |

- › Cubic inch capacity is 25,494.
- › Made of 14, 16 and 18 gauge steel.
- › Maximum weight capacity for each drawer is 200 lbs.
- › Standard red powder coat paint finish. Also available in black, blue and yellow, made to order. Contact customer service for availability.
- › Heavy-duty locks with tubular key.
- › Recessed aluminum extruded drawer pulls.
- › 100% full extension drawers.
- › Vinyl top and drawer liners included.

450HS 50" TOP CHEST - 12 DRAWER



| Product # | Color | Length In. | Height In. | Depth In. | Weight Lbs. |
|--------------|--------|------------|------------|-----------|-------------|
| J455027-12RD | Red | 50-1/2 | 27 | 25 | 370 |
| J455027-12BK | Black | 50-1/2 | 27 | 25 | 370 |
| J455027-12BL | Blue | 50-1/2 | 27 | 25 | 370 |
| J455027-12YL | Yellow | 50-1/2 | 27 | 25 | 370 |



| Quantity | Type | Length In. | Height In. | Depth In. |
|----------|-------------|------------|------------|-----------|
| 4 | Drawer | 28 | 1-3/4 | 23 |
| 2 | Drawer | 28 | 3 | 23 |
| 4 | Drawer | 13-7/16 | 1-3/4 | 23 |
| 2 | Drawer | 13-7/16 | 3 | 23 |
| 1 | Compartment | 44-1/4 | 5-1/4 | 23-1/4 |

- › Cubic inch capacity is 17,641.
- › Made of 14, 16 and 18 gauge steel.
- › Maximum weight capacity for each drawer is 125 lbs.
- › Standard red powder coat paint finish. Also available in black, blue and yellow, made to order. Contact customer service for availability.
- › Heavy-duty locks with tubular key.
- › Recessed aluminum extruded drawer pulls.
- › 100% full extension drawers.
- › Vinyl top and drawer liners included.

450HS 50" TOP CHEST - 10 DRAWER



| Product # | Color | Length In. | Height In. | Depth In. | Weight lbs. |
|--------------|--------|------------|------------|-----------|-------------|
| J455027-10RD | Red | 50-1/2 | 27 | 25 | 370 |
| J455027-10BK | Black | 50-1/2 | 27 | 25 | 370 |
| J455027-10BL | Blue | 50-1/2 | 27 | 25 | 370 |
| J455027-10YL | Yellow | 50-1/2 | 27 | 25 | 370 |



| Quantity | Type | Length In. | Height In. | Depth In. |
|----------|-------------|------------|------------|-----------|
| 2 | Drawer | 28 | 1-3/4 | 23 |
| 2 | Drawer | 28 | 3 | 23 |
| 1 | Drawer | 28 | 4 | 23 |
| 2 | Drawer | 13-7/16 | 1-3/4 | 23 |
| 2 | Drawer | 13-7/16 | 3 | 23 |
| 1 | Drawer | 28 | 4 | 23 |
| 1 | Compartment | 44-1/4 | 5-1/4 | 23-1/4 |

- › Cubic inch capacity is 18,197.
- › Made of 14, 16 and 18 gauge steel.
- › Maximum weight capacity for each drawer is 125 lbs.
- › Standard red powder coat paint finish. Also available in black, blue and yellow, made to order. Contact customer service for availability.
- › Heavy-duty locks with tubular key.
- › Recessed aluminum extruded drawer pulls.
- › 100% full extension drawers.
- › Vinyl top and drawer liners included.



450HS 50" TOP CHEST - 8 DRAWER



| Product # | Color | Length In. | Height In. | Depth In. | Weight lbs. |
|-------------|--------|------------|------------|-----------|-------------|
| J455027-8RD | Red | 50-1/2 | 27 | 25 | 370 |
| J455027-8BK | Black | 50-1/2 | 27 | 25 | 370 |
| J455027-8BL | Blue | 50-1/2 | 27 | 25 | 370 |
| J455027-8YL | Yellow | 50-1/2 | 27 | 25 | 370 |



| Quantity | Type | Length In. | Height In. | Depth In. |
|----------|-------------|------------|------------|-----------|
| 2 | Drawer | 28 | 3 | 23 |
| 2 | Drawer | 28 | 4 | 23 |
| 2 | Drawer | 13-7/16 | 3 | 23 |
| 2 | Drawer | 13-7/16 | 4 | 23 |
| 1 | Compartment | 44-1/4 | 5-1/4 | 23-1/4 |

- › Cubic inch capacity is 18,753.
- › Made of 14, 16 and 18 gauge steel.
- › Maximum weight capacity for each drawer is 125 lbs.
- › Standard red powder coat paint finish. Also available in black, blue and yellow, made to order. Contact customer service for availability.
- › Heavy-duty locks with tubular key.
- › Recessed aluminum extruded drawer pulls.
- › 100% full extension drawers.
- › Vinyl top and drawer liners included.

450HS 34" TOP CHEST - 6 DRAWER



| Product # | Color | Length In. | Height In. | Depth In. | Weight Lbs. |
|-------------|--------|------------|------------|-----------|-------------|
| J453427-6RD | Red | 34 | 27 | 25 | 235 |
| J453427-6BK | Black | 34 | 27 | 25 | 235 |
| J453427-6BL | Blue | 34 | 27 | 25 | 235 |
| J453427-6YL | Yellow | 34 | 27 | 25 | 235 |



| Quantity | Type | Length In. | Height In. | Depth In. |
|----------|-------------|------------|------------|-----------|
| 4 | Drawer | 28 | 1-3/4 | 23 |
| 2 | Drawer | 28 | 3 | 23 |
| 1 | Compartment | 27-3/4 | 5-1/4 | 23-1/4 |

- › Cubic inch capacity is 11,662.
- › Made of 14, 16 and 18 gauge steel.
- › Maximum weight capacity for each drawer is 125 lbs.
- › Standard red powder coat paint finish. Also available in black, blue and yellow, made to order. Contact customer service for availability.
- › Heavy-duty locks with tubular key.
- › Recessed aluminum extruded drawer pulls.
- › 100% full extension drawers.
- › Vinyl top and drawer liners included.



450HS 34" TOP CHEST - 5 DRAWER



| Product # | Color | Length In. | Height In. | Depth In. | Weight Lbs. |
|-------------|--------|------------|------------|-----------|-------------|
| J453427-5RD | Red | 34 | 27 | 25 | 235 |
| J453427-5BK | Black | 34 | 27 | 25 | 235 |
| J453427-5BL | Blue | 34 | 27 | 25 | 235 |
| J453427-5YL | Yellow | 34 | 27 | 25 | 235 |



| Quantity | Type | Length In. | Height In. | Depth In. |
|----------|-------------|------------|------------|-----------|
| 3 | Drawer | 28 | 1-3/4 | 23 |
| 2 | Drawer | 28 | 4 | 23 |
| 1 | Compartment | 27-3/4 | 5-1/4 | 23-1/4 |

- › Cubic inch capacity is 12,037.
- › Made of 14, 16 and 18 gauge steel.
- › Maximum weight capacity for each drawer is 125 lbs.
- › Standard red powder coat paint finish. Also available in black, blue and yellow, made to order. Contact customer service for availability.
- › Heavy-duty locks with tubular key.
- › Recessed aluminum extruded drawer pulls.
- › 100% full extension drawers.
- › Vinyl top and drawer liners included.

450HS 34" TOP CHEST - 4 DRAWER



| Product # | Color | Length In. | Height In. | Depth In. | Weight Lbs. |
|-------------|--------|------------|------------|-----------|-------------|
| J453427-4RD | Red | 34 | 27 | 25 | 235 |
| J453427-4BK | Black | 34 | 27 | 25 | 235 |
| J453427-4BL | Blue | 34 | 27 | 25 | 235 |
| J453427-4YL | Yellow | 34 | 27 | 25 | 235 |



| Quantity | Type | Length In. | Height In. | Depth In. |
|----------|-------------|------------|------------|-----------|
| 2 | Drawer | 28 | 3 | 23 |
| 2 | Drawer | 28 | 4 | 23 |
| 1 | Compartment | 27-3/4 | 5-1/4 | 23-1/4 |

- › Cubic inch capacity is 12,414.
- › Made of 14, 16 and 18 gauge steel.
- › Maximum weight capacity for each drawer is 125 lbs.
- › Standard red powder coat paint finish. Also available in black, blue and yellow, made to order. Contact customer service for availability.
- › Heavy-duty locks with tubular key.
- › Recessed aluminum extruded drawer pulls.
- › 100% full extension drawers.
- › Vinyl top and drawer liners included.

450HS SIDE CABINET - 6 DRAWER



| Product # | Color | Length In. | Height In. | Depth In. | Weight Lbs. |
|----------------|--------|------------|------------|-----------|-------------|
| J451934-6RD-SC | Red | 19-1/2 | 34 | 25 | 175 |
| J451934-6BK-SC | Black | 19-1/2 | 34 | 25 | 175 |
| J451934-6BL-SC | Blue | 19-1/2 | 34 | 25 | 175 |
| J451934-6YL-SC | Yellow | 19-1/2 | 34 | 25 | 175 |



| Quantity | Type | Length In. | Height In. | Depth In. |
|----------|--------|------------|------------|-----------|
| 3 | Drawer | 13-7/16 | 1-3/4 | 23 |
| 2 | Drawer | 13-7/16 | 4 | 23 |
| 1 | Drawer | 13-7/16 | 11 | 23 |

- › Cubic inch capacity is 7,554.
- › Made of 14, 16 and 18 gauge steel.
- › Maximum weight capacity for each drawer is 125 lbs.
- › Standard red powder coat paint finish. Also available in black, blue and yellow, made to order. Contact customer service for availability.
- › Heavy-duty locks with tubular key.
- › Recessed aluminum extruded drawer pulls.
- › 100% full extension drawers.
- › Vinyl top and drawer liners included.



450HS SIDE CABINET - 5 DRAWER



| Product # | Color | Length In. | Height In. | Depth In. | Weight lbs. |
|-----------------------|--------|------------|------------|-----------|-------------|
| J451934-5RD-SC | Red | 19-1/2 | 34 | 25 | 175 |
| J451934-5BK-SC | Black | 19-1/2 | 34 | 25 | 175 |
| J451934-5BL-SC | Blue | 19-1/2 | 34 | 25 | 175 |
| J451934-5YL-SC | Yellow | 19-1/2 | 34 | 25 | 175 |



| Quantity | Type | Length In. | Height In. | Depth In. |
|----------|--------|------------|------------|-----------|
| 1 | Drawer | 13-7/16 | 1-3/4 | 23 |
| 3 | Drawer | 13-7/16 | 4 | 23 |
| 1 | Drawer | 13-7/16 | 11 | 23 |

- › Cubic inch capacity is 7,734.
- › Made of 14, 16 and 18 gauge steel.
- › Maximum weight capacity for each drawer is 125 lbs.
- › Standard red powder coat paint finish. Also available in black, blue and yellow, made to order. Contact customer service for availability.
- › Heavy-duty locks with tubular key.
- › Recessed aluminum extruded drawer pulls.
- › 100% full extension drawers.
- › Vinyl top and drawer liners included.

450HS SIDE SHELVES

| Product # | Color | Size In. | Weight Lbs. |
|-----------------|--------|-------------|-------------|
| J45SS-RD | Red | 25 x 14-1/2 | 11.5 |
| J45SS-BK | Black | 25 x 14-1/2 | 11.5 |
| J45SS-BL | Blue | 25 x 14-1/2 | 11.5 |
| J45SS-YL | Yellow | 25 x 14-1/2 | 11.5 |

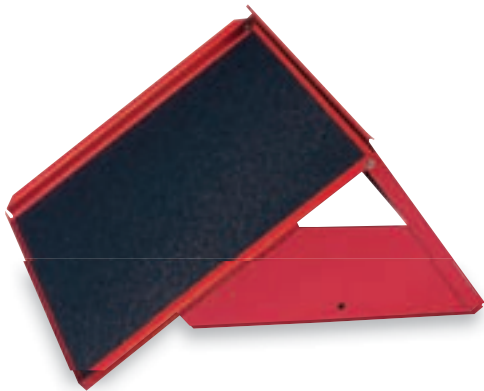

- › Use with 450 Series Workstations.
- › Heavy gauge all welded steel construction.

450HS WORKTOPS



| Product # | Description | Size In. | Weight Lbs. |
|------------------|-------------|-------------------|-------------|
| J4550-HWT | 50" | 50-1/5 x 24-13/16 | 58.0 |
| J4557-HWT | 57" | 56-7/8 x 24-13/16 | 60.0 |
| J4566-HWT | 66" | 66-1/2 x 24-13/16 | 68.0 |



- › Use with 450 Series Workstations.
- › Hardwood construction.
- › Rounded edges for a smooth finish.



440SS 54" WORKSTATION - 14 DRAWER



| Product # | Color | Length In. | Height In. | Depth In. | Weight Lbs. |
|--------------|-------|------------|------------|-----------|-------------|
| J445442-14RD | Red | 54 | 42 | 18 | 345 |
| J445442-14BK | Black | 54 | 42 | 18 | 345 |



| Quantity | Type | Length In. | Height In. | Depth In. |
|----------|--------|------------|------------|-----------|
| 2 | Drawer | 23-1/4 | 1-7/8 | 16-1/8 |
| 2 | Drawer | 23-1/4 | 1-7/8 | 16-1/8 |
| 4 | Drawer | 23-1/4 | 3-15/16 | 16-1/8 |
| 4 | Drawer | 23-1/4 | 3-15/16 | 16-1/8 |
| 1 | Drawer | 23-1/4 | 8-1/16 | 16-1/8 |
| 1 | Drawer | 23-1/4 | 1-1/16 | 16-1/8 |

- › Cubic inch capacity is 22,248.
- › Maximum weight capacity for each drawer is 100 lbs.
- › Aluminum extruded drawer pulls.
- › 100% Full extension drawers.
- › Recessed drawer pulls.
- › 100 lbs. Ball bearing slides.
- › Heavy-duty key.
- › 4-Way channel bottom panel.
- › 5" x 2" Polyurethane casters - 450 lbs./caster.
- › Vinyl top and drawer liners included.
- › Smooth, sleek and durable paint finish.
- › Heavy-duty easy grip handle.

440SS 41" WORKSTATION - 15 DRAWER



| Product # | Color | Length In. | Height In. | Depth In. | Weight Lbs. |
|--------------|-------|------------|------------|-----------|-------------|
| J444142-15RD | Red | 41 | 42 | 18 | 275 |
| J444142-15BK | Black | 41 | 42 | 18 | 275 |



| Quantity | Type | Length In. | Height In. | Depth In. |
|----------|--------|------------|------------|-----------|
| 1 | Drawer | 37-3/4 | 3-15/16 | 16-1/8 |
| 4 | Drawer | 11-1/8 | 1-7/8 | 16-1/8 |
| 2 | Drawer | 11-1/8 | 3-15/16 | 16-1/8 |
| 1 | Drawer | 11-1/8 | 8-1/16 | 16-1/8 |
| 4 | Drawer | 23-1/4 | 1-7/8 | 16-1/8 |
| 2 | Drawer | 23-1/4 | 3-15/16 | 16-1/8 |
| 1 | Drawer | 23-1/4 | 8-1/16 | 16-1/8 |

- › Cubic inch capacity is 14,362.
- › Maximum weight capacity for each drawer is 100 lbs.
- › Aluminum extruded drawer pulls.
- › 100% Full extension drawers.
- › Recessed drawer pulls.
- › 100 lbs. Ball bearing slides.
- › Heavy-duty key.
- › 4-Way channel bottom panel.
- › 5" x 2" Polyurethane casters - 450 lbs./caster.
- › Vinyl top and drawer liners included.
- › Smooth, sleek and durable paint finish.
- › Heavy-duty easy grip handle.



440SS 41" WORKSTATION - 6 DRAWER



| Product # | Color | Length In. | Height In. | Depth In. | Weight Lbs. |
|-------------|---------|------------|------------|-----------|-------------|
| J444142-6RD | ■ Red | 41 | 42 | 18 | 250 |
| J444142-6BK | ■ Black | 41 | 42 | 18 | 250 |



| Quantity | Type | Length In. | Height In. | Depth In. |
|----------|--------|------------|------------|-----------|
| 5 | Drawer | 37-3/4 | 3-15/16 | 16-1/8 |
| 1 | Drawer | 37-3/4 | 8-1/16 | 16-1/8 |

- › Cubic inch capacity is 15,588.
- › Maximum weight capacity for each drawer is 100 lbs.
- › Aluminum extruded drawer pulls.
- › 100% Full extension drawers.
- › Recessed drawer pulls.
- › 100 lbs. Ball bearing slides.
- › Heavy-duty key.
- › 4-Way channel bottom panel.
- › 5" x 2" Polyurethane casters - 450 lbs./caster.
- › Vinyl top and drawer liners included.
- › Smooth, sleek and durable paint finish.
- › Heavy-duty easy grip handle.

440SS 27" ROLLER CABINET - 12 DRAWER



| Product # | Color | Length In. | Height In. | Depth In. | Weight Lbs. |
|--------------|---------|------------|------------|-----------|-------------|
| J442742-12RD | ■ Red | 34 | 27 | 25 | 235 |
| J442742-12BK | ■ Black | 34 | 27 | 25 | 235 |
| J442742-12BL | ■ Blue | 34 | 27 | 25 | 235 |



| Quantity | Type | Length In. | Height In. | Depth In. |
|----------|--------|------------|------------|-----------|
| 1 | Drawer | 11-1/8 | 3-15/16 | 16-1/8 |
| 4 | Drawer | 5 | 1-7/8 | 16-1/8 |
| 4 | Drawer | 23-1/4 | 1-7/8 | 16-1/8 |
| 2 | Drawer | 23-1/4 | 3-15/16 | 16-1/8 |
| 1 | Drawer | 23-1/4 | 8-1/16 | 16-1/8 |

- › Cubic inch capacity is 9,420.
- › Maximum weight capacity for each drawer is 100 lbs.
- › Aluminum extruded drawer pulls.
- › 100% Full extension drawers.
- › Recessed drawer pulls.
- › 100 lbs. Ball bearing slides.
- › Heavy-duty key.
- › 4-Way channel bottom panel.
- › 5" x 2" Polyurethane casters - 450 lbs./caster.
- › Vinyl top and drawer liners included.
- › Smooth, sleek and durable paint finish.
- › Heavy-duty easy grip handle.



440SS 27" ROLLER CABINET - 11 DRAWER



| Product # | Color | Length In. | Height In. | Depth In. | Weight Lbs. |
|--------------|-------|------------|------------|-----------|-------------|
| J442742-11RD | Red | 27 | 42 | 18 | 205 |
| J442742-11BK | Black | 27 | 42 | 18 | 205 |



| Quantity | Type | Length In. | Height In. | Depth In. |
|----------|--------|------------|------------|-----------|
| 4 | Drawer | 11-1/8 | 1-7/8 | 16-1/8 |
| 4 | Drawer | 23-1/4 | 1-7/8 | 16-1/8 |
| 2 | Drawer | 23-1/4 | 3-15/16 | 16-1/8 |
| 1 | Drawer | 23-1/4 | 8-1/16 | 16-1/8 |

- › Cubic inch capacity is 9,410.
- › Maximum weight capacity for each drawer is 100 lbs.
- › Aluminum extruded drawer pulls.
- › 100% Full extension drawers.
- › Recessed drawer pulls.
- › 100 lbs. Ball bearing slides.
- › Heavy-duty key.
- › 4-Way channel bottom panel.
- › 5" x 2" Polyurethane casters - 450 lbs./caster.
- › Vinyl top and drawer liners included.
- › Smooth, sleek and durable paint finish.
- › Heavy-duty easy grip handle.

440SS 27" ROLLER CABINET - 8 DRAWER



| Product # | Color | Length In. | Height In. | Depth In. | Weight Lbs. |
|-------------|-------|------------|------------|-----------|-------------|
| J442742-8RD | Red | 27 | 42 | 18 | 190 |
| J442742-8BK | Black | 27 | 42 | 18 | 190 |



| Quantity | Type | Length In. | Height In. | Depth In. |
|----------|--------|------------|------------|-----------|
| 4 | Drawer | 11-1/8 | 1-7/8 | 16-1/8 |
| 2 | Drawer | 23-1/4 | 3-15/16 | 16-1/8 |
| 2 | Drawer | 23-1/4 | 8-1/16 | 16-1/8 |

- › Cubic inch capacity is 9,829.
- › Maximum weight capacity for each drawer is 100 lbs.
- › Aluminum extruded drawer pulls.
- › 100% Full extension drawers.
- › Recessed drawer pulls.
- › 100 lbs. Ball bearing slides.
- › Heavy-duty key.
- › 4-Way channel bottom panel.
- › 5" x 2" Polyurethane casters - 450 lbs./caster.
- › Vinyl top and drawer liners included.
- › Smooth, sleek and durable paint finish.
- › Heavy-duty easy grip handle.



440SS 27" ROLLER CABINET - 7 DRAWER



| Product # | Color | Length In. | Height In. | Depth In. | Weight Lbs. |
|-------------|-------|------------|------------|-----------|-------------|
| J442742-7RD | Red | 27 | 42 | 18 | 180 |
| J442742-7BK | Black | 27 | 42 | 18 | 180 |



| Quantity | Type | Length In. | Height In. | Depth In. |
|----------|--------|------------|------------|-----------|
| 2 | Drawer | 23-1/4 | 1-7/8 | 16-1/8 |
| 4 | Drawer | 23-1/4 | 3-15/16 | 16-1/8 |
| 1 | Drawer | 23-1/4 | 8-1/16 | 16-1/8 |

- › Cubic inch capacity is 9,747.
- › Maximum weight capacity for each drawer is 100 lbs.
- › Aluminum extruded drawer pulls.
- › 100% Full extension drawers.
- › Recessed drawer pulls.
- › 100 lbs. Ball bearing slides.
- › Heavy-duty key.
- › 4-Way channel bottom panel.
- › 5" x 2" Polyurethane casters - 450 lbs./caster.
- › Vinyl top and drawer liners included.
- › Smooth, sleek and durable paint finish.
- › Heavy-duty easy grip handle.

440SS 27" ROLLER CABINET - 7 DRAWER



| Product # | Color | Length In. | Height In. | Depth In. | Weight Lbs. |
|-------------|-------|------------|------------|-----------|-------------|
| J442735-7RD | Red | 27 | 35 | 18 | 175 |
| J442735-7BK | Black | 27 | 35 | 18 | 175 |



| Quantity | Type | Length In. | Height In. | Depth In. |
|----------|--------|------------|------------|-----------|
| 5 | Drawer | 23-1/4 | 1-7/8 | 16-1/8 |
| 1 | Drawer | 23-1/4 | 3-15/16 | 16-1/8 |
| 1 | Drawer | 23-1/4 | 8-1/16 | 16-1/8 |

- › Cubic inch capacity is 7,449.
- › Maximum weight capacity for each drawer is 100 lbs.
- › Aluminum extruded drawer pulls.
- › 100% Full extension drawers.
- › Recessed drawer pulls.
- › 100 lbs. Ball bearing slides.
- › Heavy-duty key.
- › 4-Way channel bottom panel.
- › 5" x 2" Polyurethane casters - 450 lbs./caster.
- › Vinyl top and drawer liners included.
- › Smooth, sleek and durable paint finish.
- › Heavy-duty easy grip handle.

440SS 27" ROLLER CABINET - 4 DRAWER



| Product # | Color | Length In. | Height In. | Depth In. | Weight Lbs. |
|-------------|---------|------------|------------|-----------|-------------|
| J442742-4RD | ■ Red | 27 | 42 | 18 | 175 |
| J442742-4BK | ■ Black | 27 | 42 | 18 | 175 |



| Quantity | Type | Length In. | Height In. | Depth In. |
|----------|-------------|------------|------------|-----------|
| 4 | Drawer | 23-1/4 | 3-15/16 | 16-1/8 |
| 1 | Compartment | 24 | 14 | 17 |

- › Cubic inch capacity is 11,159.
- › Maximum weight capacity for each drawer is 100 lbs.
- › Aluminum extruded drawer pulls.
- › 100% Full extension drawers.
- › Recessed drawer pulls.
- › 100 lbs. Ball bearing slides.
- › Heavy-duty key.
- › 4-Way channel bottom panel.
- › 5" x 2" Polyurethane casters - 450 lbs./caster.
- › Vinyl top and drawer liners included.
- › Smooth, sleek and durable paint finish.
- › Heavy-duty easy grip handle.

440SS 27" ROLLER CABINET - 3 DRAWER



| Product # | Color | Length In. | Height In. | Depth In. | Weight Lbs. |
|-------------|---------|------------|------------|-----------|-------------|
| J442735-3RD | ■ Red | 27 | 35 | 18 | 150 |
| J442735-3BK | ■ Black | 27 | 35 | 18 | 150 |



| Quantity | Type | Length In. | Height In. | Depth In. |
|----------|-------------|------------|------------|-----------|
| 1 | Drawer | 23-1/4 | 1-7/8 | 16-1/8 |
| 2 | Drawer | 23-1/4 | 3-15/16 | 16-1/8 |
| 1 | Compartment | 24 | 14 | 17 |

- › Cubic inch capacity is 9,000.
- › Maximum weight capacity for each drawer is 100 lbs.
- › Aluminum extruded drawer pulls.
- › 100% Full extension drawers.
- › Recessed drawer pulls.
- › 100 lbs. Ball bearing slides.
- › Heavy-duty key.
- › 4-Way channel bottom panel.
- › 5" x 2" Polyurethane casters - 450 lbs./caster.
- › Vinyl top and drawer liners included.
- › Smooth, sleek and durable paint finish.
- › Heavy-duty easy grip handle.



440SS TOOL TOWER - 6 DRAWER



| Product # | Color | Length In. | Height In. | Depth In. | Weight Lbs. |
|-------------|---------|------------|------------|-----------|-------------|
| J442752-6RD | ■ Red | 27 | 52 | 18 | 200 |
| J442752-6BK | ■ Black | 27 | 52 | 18 | 200 |



| Quantity | Type | Length In. | Height In. | Depth In. |
|----------|--------|------------|------------|-----------|
| 1 | Drawer | 23-1/4 | 1-7/8 | 16-1/8 |
| 2 | Drawer | 23-1/4 | 3-15/16 | 16-1/8 |
| 2 | Drawer | 23-1/4 | 8-1/16 | 16-1/8 |
| 1 | Drawer | 23-1/4 | 12-1/8 | 16-1/8 |

- › Cubic inch capacity is 13,716.
- › Maximum weight capacity for each drawer is 100 lbs.
- › Aluminum extruded drawer pulls.
- › 100% Full extension drawers.
- › Recessed drawer pulls.
- › 100 lbs. Ball bearing slides.
- › Heavy-duty key.
- › 4-Way channel bottom panel.
- › 5" x 2" Polyurethane casters - 450 lbs./caster.
- › Vinyl top and drawer liners included.
- › Smooth, sleek and durable paint finish.
- › Heavy-duty easy grip handle.

BASIC UTILITY CART



| Product # | Color | Length In. | Height In. | Depth In. | Weight Lbs. |
|------------|-------|------------|------------|-----------|-------------|
| J441000-RD | ■ Red | 37-1/2 | 38-1/2 | 20-1/2 | 80.0 |



- › Proto® Utility Carts have been developed to meet the increasing requirements that customers demand.
- › Basic two-shelf system.
- › Two 3" deep storage shelves.
- › Reinforced corners for structural support.
- › Heavy-duty, locking, 5" x 2" casters. Two swivel, two rigid.
- › 800 lbs. total weight capacity.
- › Red with black trim.
- › Assembly required.



440SS 54" TOP CHEST - 12 DRAWER



| Product # | Color | Length In. | Height In. | Depth In. | Weight Lbs. |
|--------------|-------|------------|------------|-----------|-------------|
| J445419-12RD | Red | 54 | 23 | 18 | 220 |
| J445419-12BK | Black | 54 | 23 | 18 | 220 |



| Quantity | Type | Length In. | Height In. | Depth In. |
|----------|--------|------------|------------|-----------|
| 5 | Drawer | 23-1/4 | 1-7/8 | 16-1/8 |
| 5 | Drawer | 23-1/4 | 1-7/8 | 16-1/8 |
| 1 | Drawer | 23-1/4 | 3-15/16 | 16-1/8 |
| 1 | Drawer | 23-1/4 | 3-15/16 | 16-1/8 |

- › Cubic inch capacity is 11,803.
- › Maximum weight capacity for each drawer is 100 lbs.
- › Aluminum extruded drawer pulls.
- › 100% Full extension drawers.
- › Recessed drawer pulls.
- › 100 lbs. Ball bearing slides.
- › Heavy-duty key.
- › Vinyl top and drawer liners included.
- › Smooth, sleek and durable paint finish.

440SS 41" TOP CHEST - 12 DRAWER



| Product # | Color | Length In. | Height In. | Depth In. | Weight Lbs. |
|--------------|-------|------------|------------|-----------|-------------|
| J444119-12RD | Red | 41 | 19 | 18 | 230 |
| J444119-12BK | Black | 41 | 19 | 18 | 230 |



| Quantity | Type | Length In. | Height In. | Depth In. |
|----------|--------|------------|------------|-----------|
| 5 | Drawer | 11-1/8 | 1-7/8 | 16-1/8 |
| 1 | Drawer | 11-1/8 | 3-15/16 | 16-1/8 |
| 5 | Drawer | 23-1/4 | 1-7/8 | 16-1/8 |
| 1 | Drawer | 23-1/4 | 3-15/16 | 16-1/8 |

- › Cubic inch capacity is 8,749.
- › Maximum weight capacity for each drawer is 100 lbs.
- › Aluminum extruded drawer pulls.
- › 100% Full extension drawers.
- › Recessed drawer pulls.
- › 100 lbs. Ball bearing slides.
- › Heavy-duty key.
- › Vinyl top and drawer liners included.
- › Smooth, sleek and durable paint finish.



440SS 27" TOP CHEST WITH DROP FRONT - 12 DRAWER



| Product # | Color | Length In. | Height In. | Depth In. | Weight Lbs. |
|----------------|---------|------------|------------|-----------|-------------|
| J442719-12RD-D | ■ Red | 26-1/4 | 19 | 18 | 155 |
| J442719-12BK-D | ■ Black | 26-1/4 | 19 | 18 | 155 |



| Quantity | Type | Length In. | Height In. | Depth In. |
|----------|--------|------------|------------|-----------|
| 6 | Drawer | 5 | 1-7/8 | 16-1/8 |
| 3 | Drawer | 11-1/8 | 1-7/8 | 16-1/8 |
| 2 | Drawer | 23-1/4 | 1-7/8 | 16-1/8 |
| 1 | Drawer | 3 | 3-15/16 | 16-1/8 |

- › Cubic inch capacity is 5,678.
- › Maximum weight capacity for each drawer is 100 lbs.
- › Aluminum extruded drawer pulls.
- › 100% Full extension drawers.
- › Recessed drawer pulls.
- › 100 lbs. Ball bearing slides.
- › Heavy-duty key.
- › Vinyl top and drawer liners included.
- › Smooth, sleek and durable paint finish.

440SS 27" TOP CHEST WITH DROP FRONT - 10 DRAWER



| Product # | Color | Length In. | Height In. | Depth In. | Weight Lbs. |
|----------------|---------|------------|------------|-----------|-------------|
| J442719-10RD-D | ■ Red | 26-1/4 | 19 | 18 | 145 |
| J442719-10BK-D | ■ Black | 26-1/4 | 19 | 18 | 145 |



| Quantity | Type | Length In. | Height In. | Depth In. |
|----------|--------|------------|------------|-----------|
| 6 | Drawer | 5 | 1-7/8 | 16-1/8 |
| 1 | Drawer | 11-1/8 | 6 | 16-1/8 |
| 2 | Drawer | 23-1/4 | 1-7/8 | 16-1/8 |
| 1 | Drawer | 23-1/4 | 3-15/16 | 16-1/8 |

- › Cubic inch capacity is 5,593.
- › Maximum weight capacity for each drawer is 100 lbs.
- › Aluminum extruded drawer pulls.
- › 100% Full extension drawers.
- › Recessed drawer pulls.
- › 100 lbs. Ball bearing slides.
- › Heavy-duty key.
- › Vinyl top and drawer liners included.
- › Smooth, sleek and durable paint finish.



440SS 27" TOP CHEST WITH DROP FRONT - 4 DRAWER



| Product # | Color | Length In. | Height In. | Depth In. | Weight Lbs. |
|---------------|---------|------------|------------|-----------|-------------|
| J442715-4RD-D | ■ Red | 26-1/4 | 15 | 12 | 50 |
| J442715-4BK-D | ■ Black | 26-1/4 | 15 | 12 | 50 |



| Quantity | Type | Length In. | Height In. | Depth In. |
|----------|--------|------------|------------|-----------|
| 3 | Drawer | 23-1/4 | 1-7/8 | 11-1/8 |
| 1 | Drawer | 23-1/4 | 3-15/16 | 11-1/8 |

- › Cubic inch capacity is 3,202.
- › Maximum weight capacity for each drawer is 100 lbs.
- › Aluminum extruded drawer pulls.
- › 100% Full extension drawers.
- › Recessed drawer pulls.
- › 100 lbs. Ball bearing slides.
- › Heavy-duty key.
- › Drawer liners included.
- › Smooth, sleek and durable paint finish.
- › Heavy-duty easy grip handle.

440SS 27" TOP CHEST WITH DROP FRONT - 6 DRAWER



| Product # | Color | Length In. | Height In. | Depth In. | Weight Lbs. |
|---------------|---------|------------|------------|-----------|-------------|
| J442715-6RD-D | ■ Red | 26-1/4 | 15 | 12 | 50 |
| J442715-6BK-D | ■ Black | 26-1/4 | 15 | 12 | 50 |



| Quantity | Type | Length In. | Height In. | Depth In. |
|----------|--------|------------|------------|-----------|
| 2 | Drawer | 5 | 1-7/8 | 11-1/8 |
| 1 | Drawer | 11-1/8 | 1-7/8 | 11-1/8 |
| 2 | Drawer | 23-1/4 | 1-7/8 | 11-1/8 |
| 1 | Drawer | 23-1/4 | 3-15/16 | 11-1/8 |

- › Cubic inch capacity is 5,850.
- › Maximum weight capacity for each drawer is 100 lbs.
- › Aluminum extruded drawer pulls.
- › 100% Full extension drawers.
- › Recessed drawer pulls.
- › Friction slides.
- › Heavy-duty key.
- › Drawer liners included.
- › Smooth, sleek and durable paint finish.
- › Heavy-duty easy grip handle.



440SS 27" TOP CHEST - 8 DRAWER



| Product # | Color | Length In. | Height In. | Depth In. | Weight Lbs. |
|-------------|-------|------------|------------|-----------|-------------|
| J442719-8RD | Red | 26-1/4 | 19 | 18 | 140 |
| J442719-8BK | Black | 26-1/4 | 19 | 18 | 140 |



| Quantity | Type | Length In. | Height In. | Depth In. |
|----------|--------|------------|------------|-----------|
| 4 | Drawer | 11-1/8 | 1-7/8 | 16-1/8 |
| 3 | Drawer | 23-1/4 | 1-7/8 | 16-1/8 |
| 1 | Drawer | 23-1/4 | 3-15/16 | 16-1/8 |

- › Cubic inch capacity is 5,990.
- › Maximum weight capacity for each drawer is 100 lbs.
- › Aluminum extruded drawer pulls.
- › 100% Full extension drawers.
- › Recessed drawer pulls.
- › 100 lbs. Ball bearing slides.
- › Heavy-duty key.
- › Vinyl top and drawer liners included.
- › Smooth, sleek and durable paint finish.

440SS 27" TOP CHEST - 6 DRAWER



| Product # | Color | Length In. | Height In. | Depth In. | Weight Lbs. |
|-------------|-------|------------|------------|-----------|-------------|
| J442719-6RD | Red | 26-1/4 | 19 | 18 | 140 |
| J442719-6BK | Black | 26-1/4 | 19 | 18 | 140 |



| Quantity | Type | Length In. | Height In. | Depth In. |
|----------|--------|------------|------------|-----------|
| 5 | Drawer | 23-1/4 | 1-7/8 | 16-1/8 |
| 1 | Drawer | 23-1/4 | 3-15/16 | 16-1/8 |

- › Cubic inch capacity is 5,850.
- › Maximum weight capacity for each drawer is 100 lbs.
- › Aluminum extruded drawer pulls.
- › 100% Full extension drawers.
- › Recessed drawer pulls.
- › 100 lbs. Ball bearing slides.
- › Heavy-duty key.
- › Vinyl top and drawer liners included.
- › Smooth, sleek and durable paint finish.



440SS 27" TOP CHEST - 5 DRAWER



| Product # | Color | Length In. | Height In. | Depth In. | Weight Lbs. |
|-------------|---------|------------|------------|-----------|-------------|
| J442719-5RD | ■ Red | 26-1/4 | 23 | 18 | 130 |
| J442719-5BK | ■ Black | 26-1/4 | 23 | 18 | 130 |



| Quantity | Type | Length In. | Height In. | Depth In. |
|----------|--------|------------|------------|-----------|
| 3 | Drawer | 23-1/4 | 1-7/8 | 16-1/8 |
| 2 | Drawer | 23-1/4 | 3-15/16 | 16-1/8 |

- › Cubic inch capacity is 5,990.
- › Maximum weight capacity for each drawer is 100 lbs.
- › Aluminum extruded drawer pulls.
- › 100% Full extension drawers.
- › Recessed drawer pulls.
- › 100 lbs. Ball bearing slides.
- › Heavy-duty key.
- › Vinyl top and drawer liners included.
- › Smooth, sleek and durable paint finish.

440SS INTERMEDIATE CHEST - 4 DRAWER



| Product # | Color | Length In. | Height In. | Depth In. | Weight Lbs. |
|----------------|---------|------------|------------|-----------|-------------|
| J442710-4RD-IC | ■ Red | 26-1/4 | 10 | 18 | 80 |
| J442710-4BK-IC | ■ Black | 26-1/4 | 10 | 18 | 80 |

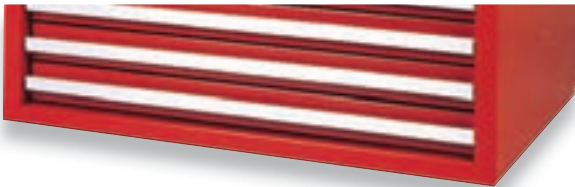

| Quantity | Type | Length In. | Height In. | Depth In. |
|----------|--------|------------|------------|-----------|
| 4 | Drawer | 23-1/4 | 1-7/8 | 16-1/8 |

- › Cubic inch capacity is 2,505.
- › Maximum weight capacity for each drawer is 100 lbs.
- › Aluminum extruded drawer pulls.
- › 100% Full extension drawers.
- › Recessed drawer pulls.
- › 100 lbs. Ball bearing slides.
- › Heavy-duty key.
- › Vinyl top and drawer liners included.
- › Smooth, sleek and durable paint finish.



440SS LOCKER CABINET - 4 DRAWER



| Product # | Color | Length In. | Height In. | Depth In. | Weight Lbs. |
|----------------|-------|------------|------------|-----------|-------------|
| J441558-4RD-LK | Red | 15 | 58 | 18 | 125 |
| J441558-4BK-LK | Black | 15 | 58 | 18 | 125 |



| Quantity | Type | Length In. | Height In. | Depth In. |
|----------|--------|------------|------------|-----------|
| 4 | Drawer | 11-1/8 | 3-15/16 | 16-1/8 |

- › Cubic inch capacity is 13,090.
- › Maximum weight capacity for each drawer is 100 lbs.
- › 100% Full extension drawers.
- › 100 lbs. Ball bearing slides.
- › Heavy-duty key.
- › Smooth, sleek and durable paint finish.

440SS SIDE CABINET - 9 DRAWER



| Product # | Color | Length In. | Height In. | Depth In. | Weight Lbs. |
|----------------|-------|------------|------------|-----------|-------------|
| J441535-9RD-SC | Red | 15 | 35 | 18 | 145 |
| J441535-9BK-SC | Black | 15 | 35 | 18 | 145 |



| Quantity | Type | Length In. | Depth In. | Height In. |
|----------|--------|------------|-----------|------------|
| 6 | Drawer | 11-1/8 | 16-1/8 | 1-7/8 |
| 2 | Drawer | 11-1/8 | 16-1/8 | 3-15/16 |
| 1 | Drawer | 11-1/8 | 16-1/8 | 8-1/16 |

- › Cubic inch capacity is 4,516.
- › Maximum weight capacity for each drawer is 100 lbs.
- › Aluminum extruded drawer pulls.
- › 100% Full extension drawers.
- › Recessed drawer pulls.
- › 100 lbs. Ball bearing slides.
- › Heavy-duty key.
- › Vinyl top and drawer liners included.
- › Smooth, sleek and durable paint finish.



440SS SIDE CABINET - 6 DRAWER



| Product # | Color | Length In. | Height In. | Depth In. | Weight Lbs. |
|----------------|-------|------------|------------|-----------|-------------|
| J441529-GRD-SC | Red | 15 | 29 | 18 | 120 |
| J441529-GBK-SC | Black | 15 | 29 | 18 | 120 |



| Quantity | Type | Length In. | Height In. | Depth In. |
|----------|--------|------------|------------|-----------|
| 3 | Drawer | 11-1/8 | 1-7/8 | 16-1/8 |
| 2 | Drawer | 11-1/8 | 3-15/16 | 16-1/8 |
| 1 | Drawer | 11-1/8 | 8-1/16 | 16-1/8 |

- › Cubic inch capacity is 3,620.
- › Maximum weight capacity for each drawer is 100 lbs.
- › Aluminum extruded drawer pulls.
- › 100% Full extension drawers.
- › Recessed drawer pulls.
- › 100 lbs. Ball bearing slides.
- › Heavy-duty key.
- › Vinyl top and drawer liners included.
- › Smooth, sleek and durable paint finish.

440SS SIDE SHELVES



| Product # | Color | Size In. | Weight Lbs. |
|-----------|-------|-------------|-------------|
| J44SS-RD | Red | 15-1/8 x 15 | 8.0 |
| J44SS-BK | Black | 15-1/8 x 15 | 8.0 |

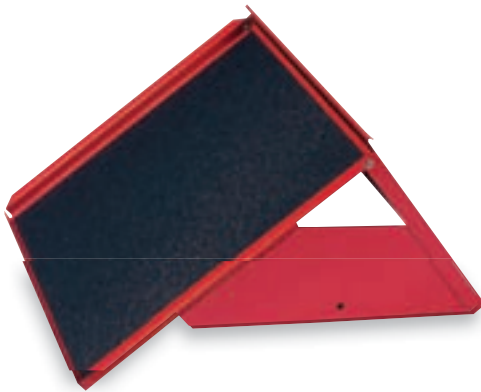

- › Use with 440 Series Workstations.
- › Heavy gauge all welded steel construction.

440SS WORKTOP

| Product # | Description | Size In. | Weight Lbs. |
|-----------|-------------|-----------------|-------------|
| J4427-HWT | 27" | 26-5/8 x 17-3/8 | 17.0 |



- › Use with 27" 440 Series Roller Cabinets.
- › Hardwood construction.
- › Rounded edges for a smooth finish.



VINYL MATS

| Product # | Length In. | Depth In. | Weight Lbs. |
|-----------|------------|-----------|-------------|
| J32532P | 26-1/2 | 17-3/4 | 1.98 |
| J32344P | 33-3/16 | 17-3/4 | 2.56 |



- › Vinyl mats protect cabinet and accessory tops.
- › Provides a skid-resistant, easy to clean workspace.

DRAWER LINER

| Product # | Weight Lbs. |
|-----------|-------------|
| J9910 | 0.24 |



- › Polyethylene foam drawer liners.
- › Keep drawers protected.
- › Cut to fit any drawer.
- › 1 roll: 24" x 60" (1,440 square inches).

GENERAL PURPOSE TOOL BOX WITH 3 DRAWERS

| Product # | Color | Capacity Cubic In. | Length In. | Height In. | Depth In. | Weight Lbs. |
|-----------|-------|--------------------|------------|------------|-----------|-------------|
| J9993-NA | Red | 2075 | 20-3/16 | 11-3/4 | 8-3/4 | 25 |



| Quantity | Type | Length In. | Depth In. | Height In. |
|----------|-------------|------------|-----------|------------|
| 1 | Compartment | 20 | 8-1/2 | 2-1/4 |
| 3 | Drawer | 18 | 7-1/4 | 1-1/2 |

GENERAL PURPOSE BOX WITH TRAY

| Product # | Color | Capacity Cubic In. | Length In. | Height In. | Depth In. | Weight Lbs. |
|-----------|-------|--------------------|------------|------------|-----------|-------------|
| J9954-NA | Red | 546 | 14 | 6-1/2 | 6 | 5.0 |
| J9977-NA | Red | 931 | 19-1/2 | 7 | 8 | 8.0 |
| J9975-NA | Red | 1,615 | 20 | 9-1/2 | 8-1/2 | 14.0 |
| J9969-NA | Red | 2,133 | 26 | 9-1/2 | 8-1/2 | 19.0 |



- › Removable steel tote tray.
- › Heavy-duty side handles.
- › Double latch for strength.
- › Padlockable center hasp for security.

HIP ROOF BOX WITH TRAY



| Product # | Color | Capacity Cubic In. | Length In. | Height In. | Depth In. | Weight Lbs. |
|-----------|-------|--------------------|------------|------------|-----------|-------------|
| J9971-NA | Red | 931 | 19 | 7 | 7 | 8.0 |



- › Removable steel tote tray.
- › Double latch for strength.
- › Hip roof lid design.

CARPENTER'S BOX



| Product # | Color | Capacity Cubic In. | Length In. | Depth In. | Height In. | Weight Lbs. |
|-----------|-------|--------------------|------------|-----------|------------|-------------|
| J9979-NA | Brown | 2,584 | 32 | 8-1/2 | 9-1/2 | 24.0 |



- › Removable steel tote tray.
- › Extra wide for large tools.
- › Double latch for strength.
- › Padlockable center hasp for security.
- › Heavy-duty side handles.

CANTILEVER BOX

| Product # | Color | Capacity Cubic In. | Length In. | Height In. | Depth In. | Weight Lbs. |
|-----------|-------|--------------------|------------|------------|-----------|-------------|
| J9951 | Black | 2,520 | 18 | 14 | 10 | 20.0 |



- › 4 trays - 2 with covers.
- › Trays swing out for easy tool access



STRUCTURAL FOAM BOX



| Product # | Color | Capacity Cubic In. | Length In. | Height In. | Depth In. | Weight Lbs. |
|-----------|-------|--------------------|------------|------------|-----------|-------------|
| J9901 | Brown | 1,502 | 20 | 10-1/2 | 8-3/4 | 8.0 |
| J9902 | Black | 2,037 | 26 | 10-1/2 | 8-3/4 | 10.5 |



- › Will not dent or chip.
- › Rust-resistant.
- › Structural foam construction.
- › Removable tote tray.

HEAVY-DUTY SET BOXES



| Product # | Color | Length In. | Height In. | Depth In. | Weight Lbs. |
|-----------|-------|------------|------------|-----------|-------------|
| J5894 | Red | 31-13/16 | 3-9/16 | 10-7/16 | 13.0 |
| J5896 | Red | 35-3/8 | 5-1/2 | 15-3/16 | 33.0 |
| J5694 | Red | 20-1/4 | 6-1/2 | 3-3/8 | 11.0 |
| J5695 | Red | 20-1/8 | 7-15/16 | 3-3/8 | 13.0 |
| J5696 | Red | 25-3/16 | 9-1/16 | 4-1/16 | 18.0 |
| J5697 | Red | 26-3/4 | 14-1/2 | 4 | 24.0 |



- › Padlockable center hasp for security.
- › Side handles.

SET BOXES



| Product # | Color | Length In. | Height In. | Depth In. | Weight Lbs. |
|-----------|-------|------------|------------|-----------|-------------|
| J4795 | Red | 7 | 1-1/4 | 3-7/16 | 0.75 |
| J4797 | Red | 10-15/16 | 1-1/4 | 3-11/16 | 1.17 |
| J5298 | Red | 17-5/16 | 1-7/8 | 5-5/16 | 2.60 |
| J5299 | Red | 10-3/8 | 1-5/8 | 4-7/16 | 1.36 |
| J5496-NA | Red | 19 | 3-7/8 | 6-1/4 | 4.00 |
| J5497 | Red | 23 | 2-3/16 | 8 | 5.20 |



- › These set boxes are used to store Socket Sets in your Tool Box or Utility Cart.
- › They also make it convenient and easy to transport a full set of sockets to the job..

PROFESSIONAL EXTRA HEAVY-DUTY LEATHER REINFORCED TOOL BAGS



| Product # | Length In. | Depth In. | Weight Lbs. |
|-----------|------------|-----------|-------------|
| J95322 | 24 | 8 | 4.25 |
| J95327 | 27 | 17 | 4.94 |



- ▶ Rugged No. 8 white canvas reinforced with top grain leather bottom.
- ▶ One-piece construction riveted to 12 gauge steel hinged frame.
- ▶ Riveted reinforced leather handles and retaining straps.
- ▶ Water-resistant fiber board bottom.
- ▶ 9" x 11" reinforced inside pocket.
- ▶ 6 metal studs to protect outside bottom wear.

PROFESSIONAL EXTRA HEAVY-DUTY REINFORCED TOOL BAGS WITH VINYL BOTTOM



| Product # | Length In. | Depth In. | Weight Lbs. |
|-----------|------------|-----------|-------------|
| J95311 | 18 | 9 | 2.73 |
| J95316 | 20 | 10-1/4 | 3.24 |



- ▶ Rugged No. 8 white canvas reinforced with tough vinyl bottom.
- ▶ One-piece construction riveted to 12 gauge steel hinged frame.
- ▶ Riveted reinforced leather handles and retaining straps.
- ▶ Water-resistant fiber board bottom.
- ▶ 6 metal studs to protect outside bottom wear.

ALL-PURPOSE CANVAS ZIPPER BAGS



| Product # | Size in. | Weight Lbs. |
|-----------|-----------|-------------|
| J95305 | 12 x 7 | 0.21 |
| J95306 | 8-1/2 x 7 | 0.28 |



- ▶ One piece construction of No. 8 canvas.
- ▶ Heavy-duty zipper.
- ▶ Ideal for storing pliers, wrenches, screwdrivers and other small tools and instruments.
- ▶ 2 convenient sizes.

STRAIGHT WALL UTILITY BUCKET



















































| Product # | Diameter In. | Height In. | Weight Lbs. |
|-----------|--------------|------------|-------------|
| J95336 | 12 | 14 | 1.64 |



- ▶ Rugged No. 4 white canvas.
- ▶ Polypropylene rope handles reinforced at top ring.
- ▶ 8" x 7" inside pocket.
- ▶ Heavy-duty die cast swivel snap hook.



CANVAS TOOL POUCH

| Product # | Number of Pockets | Length In. | Thickness In. | Weight Lbs. | |
|-----------|-------------------|------------|---------------|-------------|---|
| J25TR01C | 7 | 12 | 3/16 | 0.15 |  |
| J25TR02C | 12 | 7-1/2 | 3/32 | 0.15 |  |
| J25TR03C | 7 | 10-29/32 | 3/16 | 0.13 |  |
| J25TR04C | 5 | 14-11/16 | 3/32 | 0.18 |  |
| J25TR05C | 10 | 14-3/16 | 3/16 | 0.29 |  |
| J25TR06C | 5 | 12 | 3/32 | 0.10 |  |
| J25TR07C | 7 | 11 | 3/32 | 0.12 |  |
| J25TR08C | 14 | 15 | 3/16 | 0.36 |  |
| J25TR09C | 9 | 9-3/32 | 3/32 | 0.12 |  |
| J25TR10C | 13 | 12 | 3/32 | 0.09 |  |
| J25TR11C | 1 | 7 | 3/32 | 0.04 |  |
| J25TR12C | 8 | 7-1/2 | 3/32 | 0.05 |  |
| J25TR13C | 11 | 10-5/16 | 3/16 | 0.16 |  |
| J25TR15C | 5 | 8-13/16 | 3/32 | 0.08 |  |
| J25TR16C | 8 | 12-1/2 | 3/32 | 0.14 |  |
| J25TR17C | 3 | 10 | 3/32 | 0.07 |  |
| J25TR18C | 4 | 7-1/2 | 3/16 | 0.10 |  |
| J25TR19C | 6 | 12-5/16 | 3/16 | 0.18 |  |
| J25TR20C | 10 | 11-11/16 | 13/32 | 0.45 |  |
| J25TR21C | 26 | 16-1/2 | 3/16 | 0.47 |  |
| J25TR22C | 3 | 10 | 3/16 | 0.20 |  |
| J25TR23C | 7 | 9 | 3/16 | 0.12 |  |
| J25TR24C | 7 | 9-1/2 | 5/16 | 0.12 |  |
| J25TR25C | 6 | 8-11/16 | 3/16 | 0.09 |  |
| J25TR26C | 9 | 9-1/2 | 3/32 | 0.06 |  |
| J25TR27C | 8 | 9-1/2 | 1/2 | 0.31 |  |
| J25TR28C | 10 | 13-5/16 | 3/16 | 0.22 |  |
| J25TR29C | 7 | 11-11/16 | 3/32 | 0.15 |  |
| J25TR30C | 5 | 12 | 3/32 | 0.08 |  |
| J25TR31C | 7 | 8 | 3/32 | 0.08 |  |
| J25TR32C | 7 | 12-29/32 | 3/16 | 0.23 |  |
| J25TR33C | 7 | 11-11/16 | 3/32 | 0.17 |  |
| J25TR34C | 15 | 15 | 5/16 | 0.58 |  |
| J25TR35C | 9 | 12-29/32 | 1/32 | 0.17 |  |
| J25TR36C | 17 | 11 | 1/2 | 0.47 |  |
| J25TR37C | 7 | 11-1/2 | 3/16 | 0.17 |  |
| J25TR38C | 9 | 13-3/4 | 3/16 | 0.17 |  |
| J25TR39C | 10 | 15-5/16 | 5/16 | 0.29 |  |
| J25TR40C | 14 | 13 | 5/16 | 0.30 |  |
| J25TR41C | 15 | 12 | 13/32 | 0.57 |  |
| J25TR42C | 18 | 13 | 13/32 | 0.51 |  |
| J25TR43C | 7 | 12-29/32 | 3/32 | 0.18 |  |
| J25TR44C | 11 | 13 | 5/16 | 0.41 |  |
| J25TR45C | 8 | 9-1/2 | 2 | 0.40 |  |
| J25TR49C | 5 | 7 | 1-1/2 | 0.20 |  |
| J25TR50C | 1 | 6-1/3 | 3/16 | 0.20 |  |
| J25TR52C | 5 | 10 | 3/16 | 0.20 |  |
| J25TR53C | 3 | 10-1/4 | 3/16 | 0.20 |  |
| J25TR54C | 3 | 15-1/2 | 3/16 | 0.30 |  |



- › Red canvas.
- › Stitched and reinforced edges for strength.
- › Reinforced pockets.
- › Tie strap closure.



11-POCKET PROFESSIONAL CONSTRUCTION POUCH



Product #
J95120

Weight Lbs.
1.80



- › 2 extra capacity deep flared main pockets.
- › 2 outer pockets.
- › 6 small utility pockets.
- › 2 extra thick hammer or hatchet loops.
- › Heavy-duty, top grain moccasin leather.
- › 1 25"/30" tape ruler holder.
- › 2-1/2" wide polypropylene web belt adjusts to fit waists up to 50".

2-POCKET WAIST APRON



Product #
J95350

Weight Lbs.
0.28



- › Heavy-duty 10 oz. white canvas.
- › Triple stitched bindings and waist ties.

14-POCKET LEATHER EXTRA CAPACITY ELECTRICIAN'S TOOL POUCH

Product #
J95030

Weight Lbs.
1.43



- › 10" x 10"
- › 4 Large gusseted utility pockets and 2 preformed plier pockets.
- › 4 Screwdriver slots, 12" tape rule holder, secured T-type tape holder with swivel rivet.
- › 2-3/4" Belt slots.
- › Additional features: Sectioned pocket for torpedo level, multi-purpose tool snap, scratch awl pocket and pencil holders.
- › Heavy-duty, top grain leather.

LEATHER HAMMER HOLSTER



Product #
J95151

Weight Lbs.
0.22



- › Heavy-duty top grain saddle leather.
- › Double rivet reinforced.
- › Rust-resistant steel cradle.
- › 2-1/2" belt slots.



LEATHER UTILITY KNIFE HOLDER



Product #
J95165

Weight Lbs.
0.17



- › Open end "V" shape design.
- › Heavy-duty top grain saddle leather.

2-POCKET LEATHER CABLE SPLICER HOLDER

Product #
J95170

Weight Lbs.
0.17



- › Heavy-duty top grain saddle leather.
- › 2 flared pockets for cable splicer, knife and scissors.
- › 2-1/2" belt slots.

LEATHER FOLDING KNIFE BLADE SHEATH



Product #
J95218

Weight Lbs.
0.12



- › Preformed top grain leather holds knife securely.
- › Heavy-duty stitching and safety snap.

SAFETY TIPS



Always store a fixed-blade utility knife in a holster.



DO-IT-YOURSELF KITS

| Product # | Color | Kit Contains | Foam Size In. |
|--------------|-------------|--|--|
| DIYBK | Black/Red | Two layers of foam, instructions and low tac tracing paper | 26-1/4 x 39 1/2 top layer 1/4 base layer |
| DIYBL | Blue/Yellow | Two layers of foam, instructions and low tac tracing paper | 26-1/4 x 39 1/2 top layer 1/4 base layer |

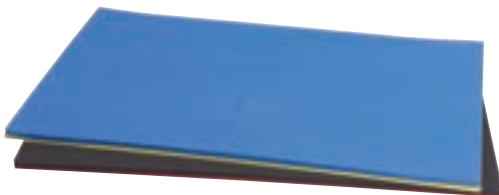

- › Proto® Industrial Tools Do-It-Yourself Kits allow you to make your FOD Kit in-house.
- › Resistant to most any chemicals, such as diesel fuel, jet fuel, cutting coolants and Skydrol®.
- › Moisture resistant.
- › Tear resistant.
- › Non-abrasive.
- › Do-It-Yourself Kits can be cut easily with a Stanley® Hobby (10-401) or Utility Knife (10-778).

LEATHER FLASHLIGHT HOLDER

- › Top grain saddle leather.
- › Will accept standard "D" size flashlights.

| Product # | Weight Lbs. |
|---------------|-------------|
| J95260 | 0.11 |



LEATHER TOOL HOLDER

- › Heavy-duty, top grain saddle leather.
- › Preformed 4" deep pocket for secure snug fit.
- › Convenient for slip joint, diagonal and up to 7" side cutting pliers, or our Infrared Temperature Readers.
- › 2-1/2" belt slots.
- › 2-3/4" x 8"

| Product # | Weight Lbs. |
|---------------|-------------|
| J95160 | 0.18 |



LEATHER TAPE HOLDER

- › This Leather Tape Rule Holder fits 25' & 30' Tapes
- › Heavy-duty top grain saddle leather
- › Preformed pockets with easy "Push up" design
- › Safety snap positioned to allow tape rules with belt clips
- › Contoured to permit use of tape blade lock
- › 2-3/4" Belt slots

| Product # | Weight Lbs. |
|---------------|-------------|
| J95140 | 0.20 |



ADJUSTABLE WEB BELTS

- › Polypropylene.
- › Fits waists up to 50 inches.

| Product # | Size In. | Weight Lbs. |
|---------------|----------|-------------|
| J95230 | up to 50 | 0.40 |



LEATHERWORK BELT

- › Heavy-duty top grain saddle leather.
- › Extra strong double tongue roller buckle.
- › Attractive embossed basket weave design.

| Product # | Size In. | Weight Lbs. |
|---------------|----------|-------------|
| J95237 | 40 - 48 | 0.52 |
| J95238 | 46 - 52 | 0.65 |



FACOM® SAFETY GLOVES



| Product # | Size In. | Length In. | Weight Lbs. |
|--------------|----------|------------|-------------|
| FT-BC.109VSE | 9 | 11-13/16 | 0.36 |
| FT-BC.110VSE | 10 | 12-19/32 | 0.43 |



- › Silicon leather to help provide mechanical protection.
- › Worn over latex insulating gloves.

SOCKET BAR SETS - 1/4" THRU 3/4"



| Product # | Drive Size In. | No. of Clips | Length In. | Weight Lbs. |
|-----------|----------------|--------------|------------|-------------|
| J2570 | 1/4 | 10 | 9 | 0.15 |
| J2571 | 1/4 | 16 | 17 | 0.23 |
| J2572 | 3/8 | 10 | 9 | 0.19 |
| J2573 | 3/8 | 16 | 17 | 0.24 |
| J2575 | 1/2 | 16 | 17 | 0.28 |
| J2576 | 3/4 | 5 | 9 | 0.19 |
| J2577 | 3/4 | 8 | 17 | 0.30 |

- › Heavy gauge all welded steel construction.



SOCKET BARS



| Product # | Length In. | Weight Lbs. |
|-----------|------------|-------------|
| J2584 | 6-1/4 | 0.06 |
| J2585 | 9 | 0.08 |
| J2588 | 11 | 0.10 |
| J2586 | 13 | 0.11 |
| J2587 | 17 | 0.15 |

- › All clips fit all bars.



SOCKET CLIPS



| Product # | Drive Size In. | Weight Lbs. |
|-----------|----------------|-------------|
| J2590 | 1/4 | 0.01 |
| J2591 | 3/8 | 0.01 |
| J2592 | 1/2 | 0.01 |
| J2594 | 3/4 | 0.01 |

- › All clips fit all bars.





WHEN SOMETHING IS MISSING YOU NEED TO KNOW

In areas that require FOD (Foreign Object Debris) prevention, nothing less than 100% tool control is acceptable. In many industries, positive tool control is absolutely necessary, not only because of the replacement cost, but also because of the tremendous risk involved when a tool goes missing.

Tool control has never been easier with Proto® Industrial Tools. Need to follow 5S or lean principles?



CUSTOM TOOL KITTING

Working in a FOD environment? Proto®, through our KitMaster™ program,

can build custom toolkits with:

- › Foam inserts, shaped by CNC routers, for a tight, reliable fit in three dimensions.
- › Laser etching for easy identification down to the tool, if needed.
- › CAD driven tool organization for any manner of cabinet, chest, box, bag or briefcase.
- › Kits can be built from the full product lines of Proto®, Blackhawk™ by Proto®, DEWALT®, Stanley®, Bostitch® and even third-party tools.

For the best levels of control and tracking, upgrade to CribMaster® RFID software for tool crib

environments and software-controlled drawers and cabinets.

KitMaster™
Industrial Kitting Solutions

SOLUTIONS BY:

StanleyBlack&Decker

 **CribMaster®**
Inventory Management System



CUSTOM FOAM

Our cross-linked polyethylene foam is thermally bonded to resist tears, stains and most chemicals. Moisture-resistant, tear-resistant and certified fire resistance, our foam comes in four standard colors or mixed to match a custom color.



LASER ETCHING

Custom laser etching prevents theft, speeds packing and sorting, and identifies the source of missing pieces quickly. Our lasers ensure clear, clean markings - letters, numbers, logos - while maintaining the integrity of the tool.



ALL KINDS OF STORAGE

Bag it, box it, stow it or shelve it. We meet exact company and industry specifications, such as GMTKs, CTKs, Tri-Cons, and Quad-Cons for military and aerospace use. We also meet TAA and BAA certification standards.

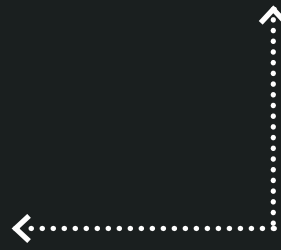
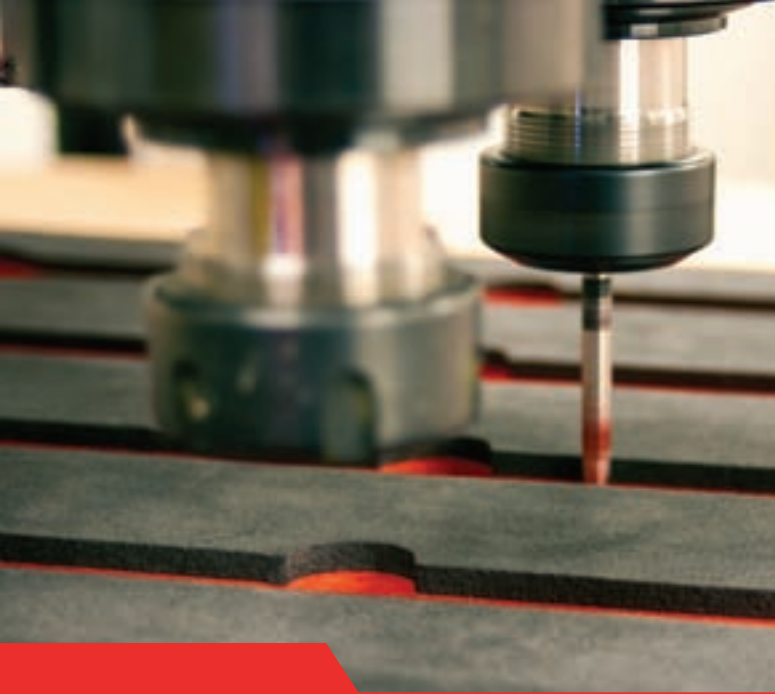

CUSTOM SHAPED INSERTS

Each tool insert is custom-shaped in three dimensions by routers. The state-of-the-art foam resists most chemicals and is non-abrasive.

RFID UPGRADE OPTIONS

For tool audit and accountability, upgrade to CribMaster® inventory management software with Last Point Read (LPR) devices to monitor tool movement and FOD finder scanners.





PROTO

**WE'VE BEEN ON THE JOB 102 YEARS.
WE BEST BE ABLE TO PUT A SET OF TOOLS TOGETHER.**



Proto®'s been on factory floors, in rail yards, at aircraft plants, and down in the mines. We've worked in manufacturing, maintenance, plumbing, electrical and electronics. Through it all, we've paid attention to what our customers need and want in trade-specific master sets. That collective knowledge goes into every set we offer. Beyond that, each set comes in Starter, Intermediate and Advanced versions, right on up to the 1,258-piece Master Technician Maintenance set. When it comes to getting the perfect set of tools for your trade, we've taken the guesswork out. And nothing else.



MASTER SETS



| | |
|--------------------------------|----------------|
| Advanced Sets | 62-139 |
| Modular Sets..... | 140-153 |
| Intermediate Sets..... | 154-181 |
| Starter Sets | 182-202 |
| Specialty Sets..... | 203-212 |
| Aviation Sets | 213-222 |
| Railroad Sets..... | 223-234 |
| HVAC Sets | 235-238 |
| Plumbing Sets..... | 239 |
| Contractor's Sets | 240 |
| Electrician's Sets..... | 241-245 |
| Sub Sets | 246-255 |

1258 PC MASTER TECHNICIAN MAINTENANCE SET

Product #: **JCS-1258MAS**



- › 1258 Pieces.
- › 1/4", 3/8", 1/2", 3/4" Drive Tools.
- › Designed for fastener sizes 1/16" - 2-3/8", 2 mm - 26 mm.
- › Tools only.
- › Contains: 664 Sockets and Accessories, 241 Wrenches, 51 Striking and Struck Tools, 39 Pliers, 91 Screwdrivers, 172 Miscellaneous Tools
- › Modules contained: JCS-MAS-1, JCS-MAS-2, JCS-MAS-3, JCS-MAS-4, JCS-MAS-5, JCS-MAS-6, JCS-MAS-7.
- › Weight: 614.0 lbs.



Representative Image; Contents May Differ

| Contents | Description |
|-----------|-------------------------------------|
| J4770A | Adapter, Universal Joint 1/4" DR |
| J5270A | Adapter, Universal Joint 3/8" DR |
| J77270P | Adapter, Universal Joint 3/8" DR |
| J5470A | Adapter, Universal Joint 1/2" DR |
| J74470P | Adapter, Universal Joint 1/2" DR |
| J5670 | Adapter, Universal Joint 3/4" DR |
| J2126 | Bar, 12" Long 1/2" Tip |
| J2130 | Bar, 16" Long 5/8" Tip |
| J2120 | Bar, Pry Aligning 18" |
| J2142 | Bar, Pry Aligning 18" |
| J2124 | Bar, Pry Aligning 24" |
| J2146 | Bar, Pry Aligning 28" |
| J61906 | Bit, 38 PC Insert Set |
| J60002 | Bit, Insert #1 Phillips® 1/4" Hex |
| J60008 | Bit, Insert #2 Phillips® 1/4" Hex |
| J60020 | Bit, Insert #3 Phillips® 1/4" Hex |
| J60050 | Bit, Insert #1 Phillips® 5/16" Hex |
| J60052 | Bit, Insert #2 Phillips® 5/16" Hex |
| J60054 | Bit, Insert #3 Phillips® 5/16" Hex |
| J60202 | Bit, Insert 3/16" Slotted 1/4" Hex |
| J60208 | Bit, Insert 9/32" Slotted 1/4" Hex |
| J60256 | Bit, Insert 10F-12R Slot 5/16" Hex |
| J60262 | Bit, Insert 14F-16R Slot 5/16" Hex |
| J6930 | Bit, Holder Power 3/8" DR 5/16" Hex |
| J6931 | Bit, Holder Power 3/8" DR 1/4" Hex |
| J9969-NA | Box, General Purpose with Tray |
| J406 | C-Clamp 0-6 |
| J404 | C-Clamps, Capacity 0"-4", 2 Each |
| J86A3/16 | Chisel, Cold 1/4" |
| J86A1/4 | Chisel, Cold 5/16" |
| J86A5/16 | Chisel, Cold 3/8" |
| J86A7/16 | Chisel, Cold 1/2" |
| J86A1/2 | Chisel, Cold 5/8" |
| J86A5/8 | Chisel, Cold 3/4" |
| J86A3/4X8 | Chisel, Cold 7/8" |
| J86A7/8X8 | Chisel, Cold 1" |
| J86A1X8 | Chisel, Cold 1-3/16" |
| J4769 | Driver, 1/4" DR |
| J7099 | Driver, Hand Impact 3/8" DR |
| J4759 | Extension, 1/4" DR 2" |
| J4759L | Extension, Locking 1/4" DR 2" |
| J4760 | Extension, 1/4" DR 3" |
| J4761 | Extension, 1/4" DR 6" |
| J4761L | Extension, Locking 1/4" DR 6" |
| J5260 | Extension, 3/8" DR 3" |
| J5260-06 | Extension, 3/8" DR 6" |
| J5260-06L | Extension, Locking 3/8" DR 6" |
| J5262 | Extension, 3/8" DR 12" |
| J5262L | Extension, Locking 3/8" DR 12" |
| J5460 | Extension, 1/2" DR 2-1/2" |





| Contents | Description |
|-----------|--|
| J5461 | Extension, 1/2" DR 5" |
| J5463 | Extension, 1/2" DR 10" |
| J5461L | Extension, Locking 1/2" DR 5" |
| J5463L | Extension, Locking 1/2" DR 10" |
| J5660 | Extension, 3/4" DR 4" |
| J5661 | Extension, 3/4" DR 8" |
| J5663 | Extension, 3/4" DR 16" |
| J4765 | Extension, Flex 1/4" DR 6-1/4" |
| J5268 | Extension, Flex 3/8" DR 8" |
| J7180P | Extension, Impact 1/2" DR 2" |
| J7181P | Extension, Impact 1/2" DR 5" |
| J4759W | Extension, Wobble 1/4" DR 2" |
| J4760W | Extension, Wobble 1/4" DR 3" |
| J5260W | Extension, Wobble 3/8" DR 3" |
| J5260-06W | Extension, Wobble 3/8" DR 6" |
| J5261W | Extension, Wobble 3/8" DR 8" |
| J5460W | Extension, Wobble 1/2" DR 2" |
| J5461W | Extension, Wobble 1/2" DR 5" |
| J5463W | Extension, Wobble 1/2" DR 10" |
| J9521 | Extractor, Screw 1/8" |
| J9522 | Extractor, Screw 3/16" |
| J9523 | Extractor, Screw 15/64" |
| J9524 | Extractor, Screw 5/16" |
| J9525 | Extractor, Screw 3/8" |
| J9525B | Extractor, Screw 15/32" |
| J9526 | Extractor, Screw 9/16" |
| J9527 | Extractor, Screw 21/32" |
| J9528 | Extractor, Screw 13/16" |
| J9529 | Extractor, Screw 1-1/16" |
| J000D | Feeler Gauge, 10 Blade Ignition Set |
| J000AA | Feeler Gauge, 25 Blade Master Set |
| J2302 | File, Ignition PT |
| 95-112W | Flashlight, Stanley® Tripod - 20 Lumens |
| 20-001 | Stanley® Hacksaw, High Tension Low Profile 12" |
| 15-809 | Stanley® Hacksaw, Metal Mini |
| J1430-HB | Hammer Head |
| J1308PD | Hammer, Ball Pein 8 oz. |
| J1316PD | Hammer, Ball Pein 16 oz. |
| J1332PD | Hammer, Ball Pein 32 oz. |
| 57-532 | Hammer, Compo-Cast® 21 oz. |
| 57-534 | Hammer, Compo-Cast® 52 oz. |
| 57-531 | Hammer, Compo-Cast® Mallet 18 oz. |
| 57-541 | Hammer, Compo-Cast® Soft-Face 14 oz. |
| 57-543 | Hammer, Compo-Cast® Soft-Face 21 oz. |
| JSF250 | Hammer, Soft: Face without Tips |
| JSF150 | Hammer, Soft: Face without Tip 1 lb |
| JSF15XH | Hammer, Tip 1-1/2" Extra Hard |
| JSF15H | Hammer, Tip 1-1/2" Hard |
| JSF15M | Hammer, Tip 1-1/2" Medium |
| JSF15MH | Hammer, Tip 1-1/2" Medium H |
| JSF15S | Hammer, Tip 1-1/2" Soft |
| JSF15SS | Hammer, Tip 1-1/2" Super Soft |
| JSF15T | Hammer, Tip 1-1/2" Tough |
| JSF25XH | Hammer, Tip 2-1/2" Extra Hard |
| JSF25H | Hammer, Tip 2-1/2" Hard |
| JSF25M | Hammer, Tip 2-1/2" Medium |
| JSF25MH | Hammer, Tip 2-1/2" Medium Hard |
| JSF25T | Hammer, Tip 2-1/2" Tough |

| Contents | Description |
|----------|---|
| J4766 | Handle, Hinge 1/4" DR 5-3/4" |
| J5265 | Handle, Hinge 3/8" DR 8-1/2" |
| J5468 | Handle, Hinge 1/2" DR |
| J5668 | Handle, Hinge 3/4" DR 20" |
| J4785 | Handle, Sliding T 1/4" DR |
| J5285 | Handle, Sliding T 3/8" DR |
| J5485 | Handle, Sliding T 1/2" DR |
| J5685 | Handle, Sliding T 3/4" DR |
| J4780G | Handle, Speed 1/4 DR |
| J5280G | Handle, Speed 3/8 DR |
| J5480G | Handle, Speed 1/2 DR |
| J4984 | Hex Key, 9 PC Metric Set |
| J4980 | Hex Key, 13 PC Standard Set |
| J4969 | Hex Key, 6 PC Metric T-Handle Set |
| J4968 | Hex Key, 11 PC Standard T-Handle Set |
| J2108 | Holder, Punch and Chisel |
| J95218 | Knife, Folding Blade |
| J18545B | Knife, Lockback 5" |
| 10-189C | Knife, Self-Retracting Utility |
| 10-099 | Knife, Stanley® Classic 99® Retractable Blade Utility |
| 42-465 | Level, Aluminum Torpedo Level (Mag) |
| J1368 | Mallet, Rubber |
| J2371 | Mirror, Inspect Oval 1 x 2 |
| J2373 | Mirror, Rectangular Telescoping 2-1/8" |
| J9206 | Nut Driver, 3/16" |
| J9207 | Nut Driver, 7/32" |
| J9208 | Nut Driver, 1/4" |
| J9209 | Nut Driver, 9/32" |
| J9210 | Nut Driver, 5/16" |
| J9211 | Nut Driver, 11/32" |
| J9212 | Nut Driver, 3/8" |
| J9214 | Nut Driver 7/16" |
| J9216 | Nut Driver, 1/2" |
| J9218 | Nut Driver, 9/16" |
| J9220 | Nut Driver, 5/8" |
| J9204M | Nut Driver, 4 mm |
| J92055M | Nut Driver, 5.5 mm |
| J9205M | Nut Driver, 5 mm |
| J9206M | Nut Driver, 6 mm |
| J9207M | Nut Driver, 7 mm |
| J9208M | Nut Driver, 8 mm |
| J9209M | Nut Driver, 9 mm |
| J9210M | Nut Driver, 10 mm |
| J9211M | Nut Driver, 11 mm |
| J9213M | Nut Driver, 13 mm |
| J9214M | Nut Driver, 14 mm |
| 82-115 | Pick and Hook, 4 PC Set |
| J2806SMP | Pliers, 6 PC Mini Set |
| J206G | Pliers, Diagonal Cutting with Grip 6-1/16" |
| J209G | Pliers, Diagonal Cutting with Grip 7-5/16" |
| J227G | Pliers, Duckbill with Grip 7-25/32" |
| J272G | Pliers, End Cutting High Leverage 8-1/4" |
| J252G | Pliers, Hose Clamp with Grip 7-3/4" |
| J235 | Pliers, Ignition with Grip 4-1/16" |
| J268G | Pliers, Lineman's with Grip 8-5/8" |
| J292NC | Pliers, Locking Curved 10" |
| J286LNXL | Pliers, Locking Mini Long Nose 6-29/32" |
| J291NC | Pliers, Locking Straight 7" |

(CONTINUED ON NEXT PAGE)

1258 PC MASTER TECHNICIAN MAINTENANCE SET (CONTINUED)

Product #: JCS-1258MAS



| Contents | Description | Contents | Description |
|----------|--|--------------|--|
| J225G | Pliers, Needle-Nose Bent Nose 6-5/16" | J4040-3 | Puller, Step Plate 1" |
| J222G | Pliers, Needle-Nose Long Thin 6-1/16" | J4040-4 | Puller, Step Plate 1-1/8" |
| J226G | Pliers, Needle-Nose with Cutter 6-5/8" | J4040-5 | Puller, Step Plate 1-1/4" |
| J360A | Pliers, 6 PC Retaining Ring Set | J4040-6 | Puller, Step Plate 1-3/8" |
| J276G | Pliers, Slip-Joint with Grip 6-9/16" | J4040-7 | Puller, Step Plate 1-1/2" |
| J278G | Pliers, Slip-Joint with Grip 8-1/16" | J4040-8 | Puller, Step Plate 1-5/8" |
| J261SG | Pliers, Tongue and Groove 5" with Grip | J4040-9 | Puller, Step Plate 1-3/4" |
| J262SG | Pliers, Tongue and Groove 6-1/2" with Grip | J4040-10 | Puller, Step Plate 1-7/8" |
| J260SG | Pliers, Tongue and Groove 10-3/16" with Grip | J4040-11 | Puller, Step Plate 2" |
| J265SG | Pliers, Tongue and Groove 16" with Grip | J4040-12 | Puller, Step Plate 2-1/8" |
| J298 | Pliers, Wire Strippers 8-1/4" | J4040-13 | Puller, Step Plate 2-1/4" |
| J4209JB | Puller, 6 Ton Jaw Block | J4040-14 | Puller, Step Plate 2-3/8" |
| J4210RJ | Puller, 6 Ton Jaw Reversible | J4012T | Puller, Tip Detachable |
| J4229JB | Puller, 10 Ton Jaw Block | J4022T | Puller, Tip Detachable Standard |
| J4280B | Puller, Blind Bearing Coll | J4250B | Puller, Yoke 2 Way Acme Th |
| J4280S | Puller, Blind Bearing Screw | J4255B | Puller, Yoke 3 Way Jaw ACM |
| J4005C | Puller, Cap Screw | J411/2 | Punch, Center 1/2" |
| J4028 | Puller, Cap Screw | J413/8 | Punch, Center 3/8" |
| J2306 | Puller, Cotter Pin Tool | J965/16 | Punch, Drift 1/8" |
| J4226CA | Puller, Crossarm 2 Way | J963/8 | Punch, Drift 3/16" |
| J4227CA | Puller, Crossarm 3 Way | J961/2 | Punch, Drift 1/4" |
| J4208CA | Puller, Crossarm 6 Ton 2 Way | J471/4X3/32 | Punch, Pin 3/32" |
| J4260R | Puller, Handle T-Rod Acme | J475/16X1/8 | Punch, Pin 1/8" |
| J4026A | Puller, Jaw 6 Ton | J475/16X5/32 | Punch, Pin 5/32" |
| J4027 | Puller, Jaw 6 Ton Narrow | J473/8X3/16 | Punch, Pin 3/16" |
| J4018 | Puller, Jaw 10 Ton Cap Screw | J477/16X7/32 | Punch, Pin 7/32" |
| J4016A | Puller, Jaw 10 Ton Dual-Reach | J471/2X1/4 | Punch, Pin 1/4" |
| J4017 | Puller, Jaw 10 Ton Narrow | J445/16 | Punch, Prick 5/16" |
| J4230RJ | Puller, Jaw 10 Ton Reversible | J501/4 | Punch, Starting 3/32" |
| J4209LS | Puller, Jaw Block Lock Screw | J505/16 | Punch, Starting 1/8" |
| J4229LS | Puller, Jaw Block Lock Screw | J503/8 | Punch, Starting 3/16" |
| J4056-2 | Puller, Jaw Inside 2 Reach | J507/16 | Punch, Starting 7/32" |
| J4256S | Puller, Jaw Inside Hook | J501/2 | Punch, Starting 1/4" |
| J4056-4 | Puller, Jaw Reversible 4 R | J5250XL | Ratchet, 3/8" DR Long Handle Pear Head |
| J4056-6 | Puller, Jaw Reversible 6 R | J5249XL | Ratchet, 3/8" DR Standard Length Premium Pear Head |
| J4250N | Puller, Nut Adjustable Reversible | J4749XL | Ratchet, 1/4" DR Standard Length Premium Pear Head |
| J4331N | Puller, Nut Hex | J5450XL | Ratchet, 1/2" DR Long Handle Pear Head |
| J4333N | Puller, Nut Hex | J5449XL | Ratchet, 1/2" DR Standard Length Premium Pear Head |
| J4056PN | Puller, Pin Pivot | J5649 | Ratchet, 3/4" DR |
| J4277B | Puller, Rear Axle Flange F | J5247 | Ratchet Adapter 3/8" DR 2-1/16" |
| J4275R | Puller, Rod Slide Acme Threader | J5447 | Ratchet Adapter 1/2" DR 2-21/32" |
| J4333AR | Puller, Rod Threader 3/4"-1" | J5257F | Ratchet, 3/8" DR Flex-Head 2-1/16" |
| J4333AR | Puller, Rod Threader 3/4"-1" | J5457F | Ratchet, 1/2" DR Flex-Head 17-3/32" |
| J4205E | Puller, Screw Cap | J2375 | Retrieval Tool, Pocket Magnetic |
| J4331R | Puller, Screw Cap | 28-540 | Scraper, Flexible 1-1/4" Wood Handle |
| J4205S | Puller, Screw Forcing Acme | 28-240 | Scraper, Flexible Nylon 1-1/4" |
| J4225S | Puller, Screw Forcing Acme | J2336 | Scrapers, Gasket and Carbon |
| J4331P | Puller, Separator Plate | J2338 | Scrapers, Gasket and Carbon |
| J4333P | Puller, Separator Plate | 66-039 | Screwdriver, 6 PC Stanley® Jewelers Precision Set |
| J4260H | Puller, Slide Hammer 2-1/2" | J88203 | Screwdriver, Slotted Cabinet, Round 1/8" x 3" |
| J4055H | Puller, Slide Hammer 5 lbs. | J88204 | Screwdriver, Slotted Cabinet, Round 1/8" x 4" |
| J4205B | Puller, Slotted Cross Arm | J88208 | Screwdriver, Slotted Cabinet, Round 1/8" x 8" |
| J4206SC | Puller, Slotted Cross Arm | J88214 | Screwdriver, Slotted Cabinet, Round 3/16" x 4" |
| J4011S | Puller, Spring Clip | J88218 | Screwdriver, Slotted Cabinet, Round 3/16" x 8" |
| J4021S | Puller, Spring Clip | | |
| J4040-1 | Puller, Step Plate 3/4" | | |
| J4040-2 | Puller, Step Plate 7/8" | | |





| Contents | Description |
|----------|---|
| J9300MS | Screwdriver, Magnetic Bit Holder |
| J9320 | Screwdriver, Magnetic Ratchet Set |
| J88393 | Screwdriver, Phillips® #0 |
| J88313 | Screwdriver, Phillips® #1 |
| J88318 | Screwdriver, Phillips® #1 |
| J88322 | Screwdriver, Phillips® #2 |
| J88324 | Screwdriver, Phillips® #2 |
| J88328 | Screwdriver, Phillips® #2 |
| J88336 | Screwdriver, Phillips® #3 |
| J88348 | Screwdriver, Phillips® #4 |
| J88102 | Screwdriver, Slotted Keystone, Square 1/4" x 2" |
| J88104 | Screwdriver, Slotted Keystone, Square 1/4" x 4" |
| J88106 | Screwdriver, Slotted Keystone, Square 1/4" x 6" |
| J88108 | Screwdriver, Slotted Keystone, Square 1/4" x 8" |
| J88112 | Screwdriver, Slotted Keystone, Square 1/4" x 12" |
| J88002 | Screwdriver, Slotted Keystone, Round 1/4" x 1-1/2" |
| 66-101 | Screwdriver, Stanley® 100 Plus® Standard Slotted Tip Pocket 1/8" x 2" |
| J88510 | Screwdriver, Torx® T10 |
| J88515 | Screwdriver, Torx® T15 |
| J88520 | Screwdriver, Torx® T20 |
| J88525 | Screwdriver, Torx® T25 |
| J88527 | Screwdriver, Torx® T27 |
| J88530 | Screwdriver, Torx® T30 |
| J88540 | Screwdriver, Torx® T40 |
| J9884 | Screw Starter, Phillips® Tip |
| J9853 | Screw Starter, Standard Tip |
| J303L | Snips, Aviation Left |
| J303R | Snips, Aviation Right |
| J303S | Snips, Aviation Straight |
| J334 | Snips, Combination 14" |
| J307 | Snips, Duckbill 7" |
| J308 | Snips, Miniature |
| J322 | Snips, Straight 12-3/4" |
| J4705 | Socket, 1/4" DR 5/32" 6 PT |
| J4706 | Socket, 1/4" DR 3/16" 6 PT |
| J4707 | Socket, 1/4" DR 7/32" 6 PT |
| J4708 | Socket, 1/4" DR 1/4" 6 PT |
| J4709 | Socket, 1/4" DR 9/32" 6 PT |
| J4710 | Socket, 1/4" DR 5/16" 6 PT |
| J4711 | Socket, 1/4" DR 11/32" 6 PT |
| J4712 | Socket, 1/4" DR 3/8" 6 PT |
| J4714 | Socket, 1/4" DR 7/16" 6 PT |
| J4716 | Socket, 1/4" DR 1/2" 6 PT |
| J4718 | Socket, 1/4" DR 9/16" 6 PT |
| J4704M | Socket, 1/4" DR 4 mm 6 PT |
| J4705M | Socket, 1/4" DR 5 mm 6 PT |
| J47055M | Socket, 1/4" DR 5.5 mm 6 PT |
| J4706M | Socket, 1/4" DR 6 mm 6 PT |
| J4707M | Socket, 1/4" DR 7 mm 6 PT |
| J4708M | Socket, 1/4" DR 8 mm 6 PT |
| J4709M | Socket, 1/4" DR 9 mm 6 PT |
| J4710M | Socket, 1/4" DR 10 mm 6 PT |
| J4711M | Socket, 1/4" DR 11 mm 6 PT |
| J4712M | Socket, 1/4" DR 12 mm 6 PT |
| J4713M | Socket, 1/4" DR 13 mm 6 PT |
| J4714M | Socket, 1/4" DR 14 mm 6 PT |
| J4706L | Socket, 1/4" DR 3/16" 6 PT Deep |
| J4707L | Socket, 1/4" DR 7/32" 6 PT Deep |

| Contents | Description |
|-----------|-----------------------------------|
| J4708L | Socket, 1/4" DR 1/4" 6 PT Deep |
| J4709L | Socket, 1/4" DR 9/32" 6 PT Deep |
| J4710L | Socket, 1/4" DR 5/16" 6 PT Deep |
| J4711L | Socket, 1/4" DR 11/32" 6 PT Deep |
| J4712L | Socket, 1/4" DR 3/8" 6 PT Deep |
| J4714L | Socket, 1/4" DR 7/16" 6 PT Deep |
| J4716L | Socket, 1/4" DR 1/2" 6 PT Deep |
| J4718L | Socket, 1/4" DR 9/16" 6 PT Deep |
| J4704LM | Socket, 1/4" DR 4 mm 6 PT Deep |
| J4705LM | Socket, 1/4" DR 5 mm 6 PT Deep |
| J47055LM | Socket, 1/4" DR 5.5 mm 6 PT Deep |
| J4706LM | Socket, 1/4" DR 6 mm 6 PT Deep |
| J4707LM | Socket, 1/4" DR 7 mm 6 PT Deep |
| J4708LM | Socket, 1/4" DR 8 mm 6 PT Deep |
| J4709LM | Socket, 1/4" DR 9 mm 6 PT Deep |
| J4710LM | Socket, 1/4" DR 10 mm 6 PT Deep |
| J4711LM | Socket, 1/4" DR 11 mm 6 PT Deep |
| J4712LM | Socket, 1/4" DR 12 mm 6 PT Deep |
| J4713LM | Socket, 1/4" DR 13 mm 6 PT Deep |
| J4714LM | Socket, 1/4" DR 14 mm 6 PT Deep |
| J4708S | Socket, 1/4" DR 1/4" 8 PT |
| J4710S | Socket, 1/4" DR 5/16" 8 PT |
| J4712S | Socket, 1/4" DR 3/8" 8 PT |
| J4705LTM | Socket, 1/4" DR 5 mm 12 PT Deep |
| J47055LTM | Socket, 1/4" DR 5.5 mm 12 PT Deep |
| J4706LTM | Socket, 1/4" DR 6 mm 12 PT Deep |
| J4707LTM | Socket, 1/4" DR 7 mm 12 PT Deep |
| J4708LTM | Socket, 1/4" DR 8 mm 12 PT Deep |
| J4709LTM | Socket, 1/4" DR 9 mm 12 PT Deep |
| J4710LTM | Socket, 1/4" DR 10 mm 12 PT Deep |
| J4711LTM | Socket, 1/4" DR 11 mm 12 PT Deep |
| J4712LTM | Socket, 1/4" DR 12 mm 12 PT Deep |
| J4713LTM | Socket, 1/4" DR 13 mm 12 PT Deep |
| J4714LTM | Socket, 1/4" DR 14 mm 12 PT Deep |
| J5206H | Socket, 3/8" DR 3/16" 6 PT |
| J5208H | Socket, 3/8" DR 1/4" 6 PT |
| J5210H | Socket, 3/8" DR 5/16" 6 PT |
| J5212H | Socket, 3/8" DR 3/8" 6 PT |
| J5214H | Socket, 3/8" DR 7/16" 6 PT |
| J5216H | Socket, 3/8" DR 1/2" 6 PT |
| J5218H | Socket, 3/8" DR 9/16" 6 PT |
| J5220H | Socket, 3/8" DR 5/8" 6 PT |
| J5222H | Socket, 3/8" DR 11/16" 6 PT |
| J5224H | Socket, 3/8" DR 3/4" 6 PT |
| J5226H | Socket, 3/8" DR 13/16" 6 PT |
| J5228H | Socket, 3/8" DR 7/8" 6 PT |
| J5230H | Socket, 3/8" DR 15/16" 6 PT |
| J5232H | Socket, 3/8" DR 1" 6 PT |
| J5221MH | Socket, 3/8" DR 21 mm 6 PT |
| J5222MH | Socket, 3/8" DR 22 mm 6 PT |
| J5223MH | Socket, 3/8" DR 23 mm 6 PT |
| J5224MH | Socket, 3/8" DR 24 mm 6 PT |
| J5225MH | Socket, 3/8" DR 25 mm 6 PT |
| J5226MH | Socket, 3/8" DR 26 mm 6 PT |
| J5008H | Socket, 3/8" DR 1/4" 6 PT Deep |
| J5010H | Socket, 3/8" DR 5/16" 6 PT Deep |
| J5012H | Socket, 3/8" DR 3/8" 6 PT Deep |
| J5014H | Socket, 3/8" DR 7/16" 6 PT Deep |
| J5016H | Socket, 3/8" DR 1/2" 6 PT Deep |

(CONTINUED ON NEXT PAGE)



1258 PC MASTER TECHNICIAN MAINTENANCE SET (CONTINUED)

Product #: **JCS-1258MAS**



| Contents | Description | Contents | Description |
|----------|---|----------|-----------------------------------|
| J5018H | Socket, 3/8" DR 9/16" 6 PT Deep | J5217M | Socket, 3/8" DR 17 mm 12 PT |
| J5020H | Socket, 3/8" DR 5/8" 6 PT Deep | J5218M | Socket, 3/8" DR 18 mm 12 PT |
| J5022H | Socket, 3/8" DR 11/16" 6 PT Deep | J5219M | Socket, 3/8" DR 19 mm 12 PT |
| J5024H | Socket, 3/8" DR 3/4" 6 PT Deep | J5221M | Socket, 3/8" DR 21 mm 12 PT |
| J5026H | Socket, 3/8" DR 13/16" 6 PT Deep | J5222M | Socket, 3/8" DR 22 mm 12 PT |
| J5028H | Socket, 3/8" DR 7/8" 6 PT Deep | J5223M | Socket, 3/8" DR 23 mm 12 PT |
| J5030H | Socket, 3/8" DR 15/16" 6 PT Deep | J5224M | Socket, 3/8" DR 24 mm 12 PT |
| J5032H | Socket, 3/8" DR 1" 6 PT Deep | J5225M | Socket, 3/8" DR 25 mm 12 PT |
| J5206HS | Socket, 3/8" DR 3/16" 6 PT Super Short | J5226M | Socket, 3/8" DR 26 mm 12 PT |
| J5208HS | Socket, 3/8" DR 1/4" 6 PT Super Short | J5008 | Socket, 3/8" DR 1/4" 12 PT Deep |
| J5210HS | Socket, 3/8" DR 5/16" 6 PT Super Short | J5010 | Socket, 3/8" DR 5/16" 12 PT Deep |
| J5212HS | Socket, 3/8" DR 3/8" 6 PT Super Short | J5012 | Socket, 3/8" DR 3/8" 12 PT Deep |
| J5214HS | Socket, 3/8" DR 7/16" 6 PT Super Short | J5014 | Socket, 3/8" DR 7/16" 12 PT Deep |
| J5216HS | Socket, 3/8" DR 1/2" 6 PT Super Short | J5016 | Socket, 3/8" DR 1/2" 12 PT Deep |
| J5218HS | Socket, 3/8" DR 9/16" 6 PT Super Short | J5018 | Socket, 3/8" DR 9/16" 12 PT Deep |
| J5220HS | Socket, 3/8" DR 5/8" 6 PT Super Short | J5020 | Socket, 3/8" DR 5/8" 12 PT Deep |
| J5222HS | Socket, 3/8" DR 11/16" 6 PT Super Short | J5022 | Socket, 3/8" DR 11/16" 12 PT Deep |
| J5224HS | Socket, 3/8" DR 3/4" 6 PT Super Short | J5024 | Socket, 3/8" DR 3/4" 12 PT Deep |
| J5209MHS | Socket, 3/8" DR 9 mm 6 PT Super Short | J5026 | Socket, 3/8" DR 13/16" 12 PT Deep |
| J5210MHS | Socket, 3/8" DR 10 mm 6 PT Super Short | J5028 | Socket, 3/8" DR 7/8" 12 PT Deep |
| J5211MHS | Socket, 3/8" DR 11 mm 6 PT Super Short | J5030 | Socket, 3/8" DR 15/16" 12 PT Deep |
| J5212MHS | Socket, 3/8" DR 12 mm 6 PT Super Short | J5032 | Socket, 3/8" DR 1" 12 PT Deep |
| J5213MHS | Socket, 3/8" DR 13 mm 6 PT Super Short | J5006M | Socket, 3/8" DR 6 mm 12 PT Deep |
| J5214MHS | Socket, 3/8" DR 14 mm 6 PT Super Short | J5008M | Socket, 3/8" DR 8 mm 12 PT Deep |
| J5215MHS | Socket, 3/8" DR 15 mm 6 PT Super Short | J5009M | Socket, 3/8" DR 9 mm 12 PT Deep |
| J5216MHS | Socket, 3/8" DR 16 mm 6 PT Super Short | J5010M | Socket, 3/8" DR 10 mm 12 PT Deep |
| J5217MHS | Socket, 3/8" DR 17 mm 6 PT Super Short | J5011M | Socket, 3/8" DR 11 mm 12 PT Deep |
| J5218MHS | Socket, 3/8" DR 18 mm 6 PT Super Short | J5012M | Socket, 3/8" DR 12 mm 12 PT Deep |
| J5219MHS | Socket, 3/8" DR 19 mm 6 PT Super Short | J5013M | Socket, 3/8" DR 13 mm 12 PT Deep |
| J5208S | Socket, 3/8" DR 1/4" 8 PT | J5014M | Socket, 3/8" DR 14 mm 12 PT Deep |
| J5210S | Socket, 3/8" DR 5/16" 8 PT | J5015M | Socket, 3/8" DR 15 mm 12 PT Deep |
| J5212S | Socket, 3/8" DR 3/8" 8 PT | J5016M | Socket, 3/8" DR 16 mm 12 PT Deep |
| J5214S | Socket, 3/8" DR 7/16" 8 PT | J5017M | Socket, 3/8" DR 17 mm 12 PT Deep |
| J5216S | Socket, 3/8" DR 1/2" 8 PT | J5018M | Socket, 3/8" DR 18 mm 12 PT Deep |
| J5208 | Socket, 3/8" DR 1/4" 12 PT | J5019M | Socket, 3/8" DR 19 mm 12 PT Deep |
| J5210 | Socket, 3/8" DR 5/16" 12 PT | J5021M | Socket, 3/8" DR 21 mm 12 PT Deep |
| J5212 | Socket, 3/8" DR 3/8" 12 PT | J5022M | Socket, 3/8" DR 22 mm 12 PT Deep |
| J5214 | Socket, 3/8" DR 7/16" 12 PT | J5023M | Socket, 3/8" DR 23 mm 12 PT Deep |
| J5216 | Socket, 3/8" DR 1/2" 12 PT | J5412H | Socket, 1/2" DR 3/8" 6 PT |
| J5218 | Socket, 3/8" DR 9/16" 12 PT | J5414H | Socket, 1/2" DR 7/16" 6 PT |
| J5220 | Socket, 3/8" DR 5/8" 12 PT | J5416H | Socket, 1/2" DR 1/2" 6 PT |
| J5222 | Socket, 3/8" DR 11/16" 12 PT | J5418H | Socket, 1/2" DR 9/16" 6 PT |
| J5224 | Socket, 3/8" DR 3/4" 12 PT | J5420H | Socket, 1/2" DR 5/8" 6 PT |
| J5226 | Socket, 3/8" DR 13/16" 12 PT | J5422H | Socket, 1/2" DR 11/16" 6 PT |
| J5228 | Socket, 3/8" DR 7/8" 12 PT | J5424H | Socket, 1/2" DR 3/4" 6 PT |
| J5230 | Socket, 3/8" DR 15/16" 12 PT | J5426H | Socket, 1/2" DR 13/16" 6 PT |
| J5232 | Socket, 3/8" DR 1" 12 PT | J5428H | Socket, 1/2" DR 7/8" 6 PT |
| J5208M | Socket, 3/8" DR 8 mm 12 PT | J5430H | Socket, 1/2" DR 15/16" 6 PT |
| J5209M | Socket, 3/8" DR 9 mm 12 PT | J5432H | Socket, 1/2" DR 1" 6 PT |
| J5210M | Socket, 3/8" DR 10 mm 12 PT | J5434H | Socket, 1/2" DR 1-1/16" 6 PT |
| J5211M | Socket, 3/8" DR 11 mm 12 PT | J5436H | Socket, 1/2" DR 1-1/8" 6 PT |
| J5212M | Socket, 3/8" DR 12 mm 12 PT | J5438H | Socket, 1/2" DR 1-3/16" 6 PT |
| J5213M | Socket, 3/8" DR 13 mm 12 PT | J5440H | Socket, 1/2" DR 1-1/4" 6 PT |
| J5214M | Socket, 3/8" DR 14 mm 12 PT | J5312H | Socket, 1/2" DR 3/8" 6 PT Deep |
| J5215M | Socket, 3/8" DR 15 mm 12 PT | J5314H | Socket, 1/2" DR 7/16" 6 PT Deep |
| J5216M | Socket, 3/8" DR 16 mm 12 PT | J5316H | Socket, 1/2" DR 1/2" 6 PT Deep |





| Contents | Description |
|-----------------|-----------------------------------|
| J5318H | Socket, 1/2" DR 9/16" 6 PT Deep |
| J5320H | Socket, 1/2" DR 5/8" 6 PT Deep |
| J5322H | Socket, 1/2" DR 11/16" 6 PT Deep |
| J5324H | Socket, 1/2" DR 3/4" 6 PT Deep |
| J5326H | Socket, 1/2" DR 13/16" 6 PT Deep |
| J5328H | Socket, 1/2" DR 7/8" 6 PT Deep |
| J5330H | Socket, 1/2" DR 15/16" 6 PT Deep |
| J5332H | Socket, 1/2" DR 1" 6 PT Deep |
| J5334H | Socket, 1/2" DR 1-1/16" 6 PT Deep |
| J5336H | Socket, 1/2" DR 1-1/8" 6 PT Deep |
| J5338H | Socket, 1/2" DR 1-3/16" 6 PT Deep |
| J5340H | Socket, 1/2" DR 1-1/4" 6 PT Deep |
| J5342H | Socket, 1/2" DR 1-5/16" 6 PT Deep |
| J5344H | Socket, 1/2" DR 1-3/8" 6 PT Deep |
| J5346H | Socket, 1/2" DR 1-7/16" 6 PT Deep |
| J5348H | Socket, 1/2" DR 1-1/2" 6 PT Deep |
| J5412S | Socket, 1/2" DR 3/8" 8 PT |
| J5414S | Socket, 1/2" DR 7/16" 8 PT |
| J5416S | Socket, 1/2" DR 1/2" 8 PT |
| J5418S | Socket, 1/2" DR 9/16" 8 PT |
| J5420S | Socket, 1/2" DR 5/8" 8 PT |
| J5422S | Socket, 1/2" DR 11/16" 8 PT |
| J5424S | Socket, 1/2" DR 3/4" 8 PT |
| J5426S | Socket, 1/2" DR 13/16" 8 PT |
| J5428S | Socket, 1/2" DR 7/8" 8 PT |
| J5432S | Socket, 1/2" DR 1" 8 PT |
| J5412 | Socket, 1/2" DR 3/8" 12 PT |
| J5414 | Socket, 1/2" DR 7/16" 12 PT |
| J5416 | Socket, 1/2" DR 1/2" 12 PT |
| J5418 | Socket, 1/2" DR 9/16" 12 PT |
| J5419 | Socket, 1/2" DR 19/32" 12 PT |
| J5420 | Socket, 1/2" DR 5/8" 12 PT |
| J5422 | Socket, 1/2" DR 11/16" 12 PT |
| J5424 | Socket, 1/2" DR 3/4" 12 PT |
| J5425 | Socket, 1/2" DR 25/32" 12 PT |
| J5426 | Socket, 1/2" DR 13/16" 12 PT |
| J5428 | Socket, 1/2" DR 7/8" 12 PT |
| J5429 | Socket, 1/2" DR 29/32" 12 PT |
| J5430 | Socket, 1/2" DR 15/16" 12 PT |
| J5432 | Socket, 1/2" DR 1" 12 PT |
| J5434 | Socket, 1/2" DR 1-1/16" 12 PT |
| J5436 | Socket, 1/2" DR 1-1/8" 12 PT |
| J5440 | Socket, 1/2" DR 1-1/4" 12 PT |
| J5438 | Socket, 1/2" DR 1-3/16" 12 PT |
| J5442 | Socket, 1/2" DR 1-5/16" 12 PT |
| J5444 | Socket, 1/2" DR 1-3/8" 12 PT |
| J5446 | Socket, 1/2" DR 1-7/16" 12 PT |
| J5448 | Socket, 1/2" DR 1-1/2" 12 PT |
| J5410M | Socket, 1/2" DR 10 mm 12 PT |
| J5411M | Socket, 1/2" DR 11 mm 12 PT |
| J5412M | Socket, 1/2" DR 12 mm 12 PT |
| J5413M | Socket, 1/2" DR 13 mm 12 PT |
| J5414M | Socket, 1/2" DR 14 mm 12 PT |
| J5415M | Socket, 1/2" DR 15 mm 12 PT |
| J5416M | Socket, 1/2" DR 16 mm 12 PT |
| J5417M | Socket, 1/2" DR 17 mm 12 PT |
| J5418M | Socket, 1/2" DR 18 mm 12 PT |
| J5419M | Socket, 1/2" DR 19 mm 12 PT |

| Contents | Description |
|-----------------|---------------------------------------|
| J5420M | Socket, 1/2" DR 20 mm 12 PT |
| J5421M | Socket, 1/2" DR 21 mm 12 PT |
| J5422M | Socket, 1/2" DR 22 mm 12 PT |
| J5423M | Socket, 1/2" DR 23 mm 12 PT |
| J5424M | Socket, 1/2" DR 24 mm 12 PT |
| J5316 | Socket, 1/2" DR 1/2" 12 PT Deep |
| J5318 | Socket, 1/2" DR 9/16" 12 PT Deep |
| J5320 | Socket, 1/2" DR 5/8" 12 PT Deep |
| J5322 | Socket, 1/2" DR 11/16" 12 PT Deep |
| J5324 | Socket, 1/2" DR 3/4" 12 PT Deep |
| J5326 | Socket, 1/2" DR 13/16" 12 PT Deep |
| J5328 | Socket, 1/2" DR 7/8" 12 PT Deep |
| J5330 | Socket, 1/2" DR 15/16" 12 PT Deep |
| J5332 | Socket, 1/2" DR 1" 12 PT Deep |
| J5334 | Socket, 1/2" DR 1-1/16" 12 PT Deep |
| J5336 | Socket, 1/2" DR 1-1/8" 12 PT Deep |
| J5340 | Socket, 1/2" DR 1-1/4" 12 PT Deep |
| J5310M | Socket, 1/2" DR 10 mm 12 PT Deep |
| J5311M | Socket, 1/2" DR 11 mm 12 PT Deep |
| J5312M | Socket, 1/2" DR 12 mm 12 PT Deep |
| J5313M | Socket, 1/2" DR 13 mm 12 PT Deep |
| J5314M | Socket, 1/2" DR 14 mm 12 PT Deep |
| J5315M | Socket, 1/2" DR 15 mm 12 PT Deep |
| J5316M | Socket, 1/2" DR 16 mm 12 PT Deep |
| J5317M | Socket, 1/2" DR 17 mm 12 PT Deep |
| J5318M | Socket, 1/2" DR 18 mm 12 PT Deep |
| J5319M | Socket, 1/2" DR 19 mm 12 PT Deep |
| J5320M | Socket, 1/2" DR 20 mm 12 PT Deep |
| J5321M | Socket, 1/2" DR 21 mm 12 PT Deep |
| J5322M | Socket, 1/2" DR 22 mm 12 PT Deep |
| J5323M | Socket, 1/2" DR 23 mm 12 PT Deep |
| J5324M | Socket, 1/2" DR 24 mm 12 PT Deep |
| J5475A | Socket, 1/2" DR 1/2" Universal 12 PT |
| J5476A | Socket, 1/2" DR 9/16" Universal 12 PT |
| J5477A | Socket, 1/2" DR 5/8" Universal 12 PT |
| J5444A | Socket, 1/2" DR Drag Link 3/4" |
| J5528 | Socket, 3/4" DR 7/8" 12 PT |
| J5530 | Socket, 3/4" DR 15/16" 12 PT |
| J5532 | Socket, 3/4" DR 1" 12 PT |
| J5534 | Socket, 3/4" DR 1-1/16" 12 PT |
| J5536 | Socket, 3/4" DR 1-1/8" 12 PT |
| J5538 | Socket, 3/4" DR 1-3/16" 12 PT |
| J5540 | Socket, 3/4" DR 1-1/4" 12 PT |
| J5542 | Socket, 3/4" DR 1-5/16" 12 PT |
| J5544 | Socket, 3/4" DR 1-3/8" 12 PT |
| J5546 | Socket, 3/4" DR 1-7/16" 12 PT |
| J5548 | Socket, 3/4" DR 1-1/2" 12 PT |
| J5550 | Socket, 3/4" DR 1-9/16" 12 PT |
| J5552 | Socket, 3/4" DR 1-5/8" 12 PT |
| J5554 | Socket, 3/4" DR 1-11/16" 12 PT |
| J5556 | Socket, 3/4" DR 1-3/4" 12 PT |
| J5558 | Socket, 3/4" DR 1-13/16" 12 PT |
| J5560 | Socket, 3/4" DR 1-7/8" 12 PT |
| J5564 | Socket, 3/4" DR 2" 12 PT |
| J5568 | Socket, 3/4" DR 2-1/8" 12 PT |
| J5570 | Socket, 3/4" DR 2-3/16" 12 PT |
| J5572 | Socket, 3/4" DR 2-1/4" 12 PT |
| J5576 | Socket, 3/4" DR 2-3/8" 12 PT |

(CONTINUED ON NEXT PAGE)

1258 PC MASTER TECHNICIAN MAINTENANCE SET (CONTINUED)

Product #: JCS-1258MAS



| Contents | Description | Contents | Description |
|------------|---|-------------|--------------------------------------|
| J4744 | Socket, Bit 1/4" DR Slotted 3/16" | J54415/8 | Socket, Hex Bit 1/2" DR 5/8" |
| J4737 | Socket, Bit 1/4" DR #1 Phillips® | J5441-12M | Socket, Hex Bit 1/2" DR 12 mm |
| J4738 | Socket, Bit 1/4" DR #2 Phillips® | J5441-14M | Socket, Hex Bit 1/2" DR 14 mm |
| J4745 | Socket, Bit 1/4" DR Slotted 1/4" 1-13/64" | J5441-17M | Socket, Hex Bit 1/2" DR 17 mm |
| J4739-10W | Socket, Bit 1/4" DR T10 Torx® | J49901/8 | Socket, Hex Bit 3/8" DR 1/8" |
| J4739-15W | Socket, Bit 1/4" DR T15 Torx® | J49905/32 | Socket, Hex Bit 3/8" DR 5/32" |
| J4739-20W | Socket, Bit 1/4" DR T20 Torx® | J49903/16 | Socket, Hex Bit 3/8" DR 3/16" |
| J4739-25W | Socket, Bit 1/4" DR T25 Torx® | J49907/32 | Socket, Hex Bit 3/8" DR 7/32" |
| J4739-27W | Socket, Bit 1/4" DR T27 Torx® | J49901/4 | Socket, Hex Bit 3/8" DR 1/4" |
| J4739-30W | Socket, Bit 1/4" DR T30 Torx® | J49905/16 | Socket, Hex Bit 3/8" DR 5/16" |
| J5241 | Socket, Bit 3/8" DR #2 Phillips® | J49903/8 | Socket, Hex Bit 3/8" DR 3/8" |
| J5242 | Socket, Bit 3/8" DR #3 Phillips® | J4990-4M | Socket, Hex Bit 3/8" DR 4 mm |
| J5243 | Socket, Bit 3/8" DR #4 Phillips® | J4990-5M | Socket, Hex Bit 3/8" DR 5 mm |
| J4743 | Socket, Bit 1/4" DR Slotted 1/4" 1-3/16" | J4990-6M | Socket, Hex Bit 3/8" DR 6 mm |
| J5246 | Socket, Bit 3/8" DR Slotted | J4990-7M | Socket, Hex Bit 3/8" DR 7 mm |
| J5239-15W | Socket, Bit 3/8" DR T15 Torx® | J4990-8M | Socket, Hex Bit 3/8" DR 8 mm |
| J5239-20W | Socket, Bit 3/8" DR T20 Torx® | J4990-9M | Socket, Hex Bit 3/8" DR 9 mm |
| J5239-25W | Socket, Bit 3/8" DR T25 Torx® | J4990-10M | Socket, Hex Bit 3/8" DR 10 mm |
| J5239-27W | Socket, Bit 3/8" DR T27 Torx® | J54411/4XL | Socket, Hex Bit 1/2" DR 1/4" X-Long |
| J5239-30W | Socket, Bit 3/8" DR T30 Torx® | J54415/16XL | Socket, Hex Bit 1/2" DR 5/16" X-Long |
| J5239-40W | Socket, Bit 3/8" DR T40 Torx® | J54413/8XL | Socket, Hex Bit 1/2" DR 3/8" X-Long |
| J5239-45W | Socket, Bit 3/8" DR T45 Torx® | J54411/2XL | Socket, Hex Bit 1/2" DR 1/2" X-Long |
| J5239-50W | Socket, Bit 3/8" DR T50 Torx® | J54419/16XL | Socket, Hex Bit 1/2" DR 9/16" X-Long |
| J69X09 | Socket, Extractor 1/4" DR 7 mm | J54415/8XL | Socket, Hex Bit 1/2" DR 5/8" X-Long |
| J69X10 | Socket, Extractor 1/4" DR 8 mm | J4990-4MXL | Socket, Hex Bit 3/8" DR 4 mm X-Long |
| J69X11 | Socket, Extractor 1/4" DR 9 mm | J4990-5MXL | Socket, Hex Bit 3/8" DR 5 mm X-Long |
| J69X13 | Socket, Extractor 1/4" DR 10 mm | J4990-6MXL | Socket, Hex Bit 3/8" DR 6 mm X-Long |
| J69X14 | Socket, Extractor 1/4" DR 11 mm | J4990-7MXL | Socket, Hex Bit 3/8" DR 7 mm X-Long |
| J69X15 | Socket, Extractor 1/4" DR 12 mm | J4990-8MXL | Socket, Hex Bit 3/8" DR 8 mm X-Long |
| J69X16 | Socket, Extractor 1/4" DR 13 mm | J4990-10MXL | Socket, Hex Bit 3/8" DR 10 mm X-Long |
| J69X18 | Socket, Extractor 1/4" DR 14 mm | J7208H | Socket, Impact 3/8" DR 1/4" 6 PT |
| J69X20 | Socket, Extractor 1/4" DR 15 mm | J7209H | Socket, Impact 3/8" DR 9/32" 6 PT |
| J69X12 | Socket, Extractor 3/8" | J7210H | Socket, Impact 3/8" DR 5/16" 6 PT |
| J47701/16 | Socket, Hex Bit 1/4" DR 1/16" | J7211H | Socket, Impact 3/8" DR 11/32" 6 PT |
| J47705/64 | Socket, Hex Bit 1/4" DR 5/64" | J7212H | Socket, Impact 3/8" DR 3/8" 6 PT |
| J47703/32 | Socket, Hex Bit 1/4" DR 3/32" | J7214H | Socket, Impact 3/8" DR 7/16" 6 PT |
| J47707/64 | Socket, Hex Bit 1/4" DR 7/64" | J7216H | Socket, Impact 3/8" DR 1/2" 6 PT |
| J47701/8 | Socket, Hex Bit 1/4" DR 1/8" | J7218H | Socket, Impact 3/8" DR 9/16" 6 PT |
| J47709/64 | Socket, Hex Bit 1/4" DR 9/64" | J7220H | Socket, Impact 3/8" DR 5/8" 6 PT |
| J47705/32 | Socket, Hex Bit 1/4" DR 5/32" | J7222H | Socket, Impact 3/8" DR 11/16" 6 PT |
| J47703/16 | Socket, Hex Bit 1/4" DR 3/16" | J7224H | Socket, Impact 3/8" DR 3/4" 6 PT |
| J47707/32 | Socket, Hex Bit 1/4" DR 7/32" | J7226H | Socket, Impact 3/8" DR 13/16" 6 PT |
| J47701/4 | Socket, Hex Bit 1/4" DR 1/4" | J7228H | Socket, Impact 3/8" DR 7/8" 6 PT |
| J47705/16 | Socket, Hex Bit 1/4" DR 5/16" | J7230H | Socket, Impact 3/8" DR 15/16" 6 PT |
| J4770-2M | Socket, Hex Bit 1/4" DR 2 mm | J7232H | Socket, Impact 3/8" DR 1" 6 PT |
| J4770-2.5M | Socket, Hex Bit 1/4" DR 2.5 mm | J7412H | Socket, Impact 1/2" DR 3/8" 6 PT |
| J4770-3M | Socket, Hex Bit 1/4" DR 3 mm | J7414H | Socket, Impact 1/2" DR 7/16" 6 PT |
| J4770-4M | Socket, Hex Bit 1/4" DR 4 mm | J7416H | Socket, Impact 1/2" DR 1/2" 6 PT |
| J4770-5M | Socket, Hex Bit 1/4" DR 5 mm | J7418H | Socket, Impact 1/2" DR 9/16" 6 PT |
| J4770-6M | Socket, Hex Bit 1/4" DR 6 mm | J7420H | Socket, Impact 1/2" DR 5/8" 6 PT |
| J54411/4 | Socket, Hex Bit 1/2" DR 1/4" | J7422H | Socket, Impact 1/2" DR 11/16" 6 PT |
| J54415/16 | Socket, Hex Bit 1/2" DR 5/16" | J7424H | Socket, Impact 1/2" DR 3/4" 6 PT |
| J54413/8 | Socket, Hex Bit 1/2" DR 3/8" | J7426H | Socket, Impact 1/2" DR 13/16" 6 PT |
| J54417/16 | Socket, Hex Bit 1/2" DR 7/16" | J7428H | Socket, Impact 1/2" DR 7/8" 6 PT |
| J54411/2 | Socket, Hex Bit 1/2" DR 1/2" | J7430H | Socket, Impact 1/2" DR 15/16" 6 PT |
| J54419/16 | Socket, Hex Bit 1/2" DR 9/16" | J7432H | Socket, Impact 1/2" DR 1" 6 PT |





| Contents | Description |
|-----------------|--|
| J7434H | Socket, Impact 1/2" DR 1-1/16" 6 PT |
| J7436H | Socket, Impact 1/2" DR 1-1/8" 6 PT |
| J7438H | Socket, Impact 1/2" DR 1-3/16" 6 PT |
| J7440H | Socket, Impact 1/2" DR 1-1/4" 6 PT |
| J7410M | Socket, Impact 1/2" DR 10 mm 6 PT |
| J7411M | Socket, Impact 1/2" DR 11 mm 6 PT |
| J7412M | Socket, Impact 1/2" DR 12 mm 6 PT |
| J7413M | Socket, Impact 1/2" DR 13 mm 6 PT |
| J7414M | Socket, Impact 1/2" DR 14 mm 6 PT |
| J7415M | Socket, Impact 1/2" DR 15 mm 6 PT |
| J7416M | Socket, Impact 1/2" DR 16 mm 6 PT |
| J7417M | Socket, Impact 1/2" DR 17 mm 6 PT |
| J7418M | Socket, Impact 1/2" DR 18 mm 6 PT |
| J7419M | Socket, Impact 1/2" DR 19 mm 6 PT |
| J7420M | Socket, Impact 1/2" DR 20 mm 6 PT |
| J7421M | Socket, Impact 1/2" DR 21 mm 6 PT |
| J7422M | Socket, Impact 1/2" DR 22 mm 6 PT |
| J7423M | Socket, Impact 1/2" DR 23 mm 6 PT |
| J7424M | Socket, Impact 1/2" DR 24 mm 6 PT |
| J7312H | Socket, Impact 1/2" DR 3/8" 6 PT Deep |
| J7314H | Socket, Impact 1/2" DR 7/16" 6 PT Deep |
| J7316H | Socket, Impact 1/2" DR 1/2" 6 PT Deep |
| J7318H | Socket, Impact 1/2" DR 9/16" 6 PT Deep |
| J7320H | Socket, Impact 1/2" DR 5/8" 6 PT Deep |
| J7322H | Socket, Impact 1/2" DR 11/16" 6 PT Deep |
| J7324H | Socket, Impact 1/2" DR 3/4" 6 PT Deep |
| J7326H | Socket, Impact 1/2" DR 13/16" 6 PT Deep |
| J7328H | Socket, Impact 1/2" DR 7/8" 6 PT Deep |
| J7330H | Socket, Impact 1/2" DR 15/16" 6 PT Deep |
| J7332H | Socket, Impact 1/2" DR 1" 6 PT Deep |
| J7334H | Socket, Impact 1/2" DR 1-1/16" 6 PT Deep |
| J7336H | Socket, Impact 1/2" DR 1-1/8" 6 PT Deep |
| J7338H | Socket, Impact 1/2" DR 1-3/16" 6 PT Deep |
| J7340H | Socket, Impact 1/2" DR 1-1/4" 6 PT Deep |
| J7342H | Socket, Impact 1/2" DR 1-5/16" 6 PT Deep |
| J7344H | Socket, Impact 1/2" DR 1-3/8" 6 PT Deep |
| J7346H | Socket, Impact 1/2" DR 1-7/16" 6 PT Deep |
| J7348H | Socket, Impact 1/2" DR 1-1/2" 6 PT Deep |
| J7310M | Socket, Impact 1/2" DR 10 mm 6 PT Deep |
| J7311M | Socket, Impact 1/2" DR 11 mm 6 PT Deep |
| J7312M | Socket, Impact 1/2" DR 12 mm 6 PT Deep |
| J7313M | Socket, Impact 1/2" DR 13 mm 6 PT Deep |
| J7314M | Socket, Impact 1/2" DR 14 mm 6 PT Deep |
| J7315M | Socket, Impact 1/2" DR 15 mm 6 PT Deep |
| J7316M | Socket, Impact 1/2" DR 16 mm 6 PT Deep |
| J7317M | Socket, Impact 1/2" DR 17 mm 6 PT Deep |
| J7318M | Socket, Impact 1/2" DR 18 mm 6 PT Deep |
| J7319M | Socket, Impact 1/2" DR 19 mm 6 PT Deep |
| J7320M | Socket, Impact 1/2" DR 20 mm 6 PT Deep |
| J7321M | Socket, Impact 1/2" DR 21 mm 6 PT Deep |
| J7322M | Socket, Impact 1/2" DR 22 mm 6 PT Deep |
| J7323M | Socket, Impact 1/2" DR 23 mm 6 PT Deep |
| J7324M | Socket, Impact 1/2" DR 24 mm 6 PT Deep |
| J07512 | Socket, Impact 3/4" DR 3/4" 6 PT |
| J07513 | Socket, Impact 3/4" DR 13/16" 6 PT |
| J07514 | Socket, Impact 3/4" DR 7/8" 6 PT |
| J07515 | Socket, Impact 3/4" DR 15/16" 6 PT |
| J07516 | Socket, Impact 3/4" DR 1" 6 PT |

| Contents | Description |
|-----------------|--|
| J07517 | Socket, Impact 3/4" DR 1-1/16" 6 PT |
| J07518 | Socket, Impact 3/4" DR 1-1/8" 6 PT |
| J07519 | Socket, Impact 3/4" DR 1-3/16" 6 PT |
| J07520 | Socket, Impact 3/4" DR 1-1/4" 6 PT |
| J07521 | Socket, Impact 3/4" DR 1-5/16" 6 PT |
| J7316HT | Socket, Impact 1/2" DR 1/2" Thin Wall |
| J7318HT | Socket, Impact 1/2" DR 9/16" Thin Wall |
| J7320HT | Socket, Impact 1/2" DR 5/8" Thin Wall |
| J7322HT | Socket, Impact 1/2" DR 11/16" Thin Wall |
| J7324HT | Socket, Impact 1/2" DR 3/4" Thin Wall |
| J7326HT | Socket, Impact 1/2" DR 13/16" Thin Wall |
| J7328HT | Socket, Impact 1/2" DR 7/8" Thin Wall |
| J7330HT | Socket, Impact 1/2" DR 15/16" Thin Wall |
| J7332HT | Socket, Impact 1/2" DR 1" Thin Wall |
| J7334HT | Socket, Impact 1/2" DR 1-1/16" Thin Wall |
| J7336HT | Socket, Impact 1/2" DR 1-1/8" Thin Wall |
| J7338HT | Socket, Impact 1/2" DR 1-3/16" Thin Wall |
| J7340HT | Socket, Impact 1/2" DR 1-1/4" Thin Wall |
| J7314MHT | Socket, Impact 1/2" DR 14 mm Thin Wall |
| J7315MHT | Socket, Impact 1/2" DR 15 mm Thin Wall |
| J7316MHT | Socket, Impact 1/2" DR 16 mm Thin Wall |
| J7317MHT | Socket, Impact 1/2" DR 17 mm Thin Wall |
| J7318MHT | Socket, Impact 1/2" DR 18 mm Thin Wall |
| J7319MHT | Socket, Impact 1/2" DR 19 mm Thin Wall |
| J7320MHT | Socket, Impact 1/2" DR 20 mm Thin Wall |
| J7321MHT | Socket, Impact 1/2" DR 21 mm Thin Wall |
| J7322MHT | Socket, Impact 1/2" DR 22 mm Thin Wall |
| J7323MHT | Socket, Impact 1/2" DR 23 mm Thin Wall |
| J7324MHT | Socket, Impact 1/2" DR 24 mm Thin Wall |
| J7708HT | Socket, Impact 3/8" DR 1/4" Deep Thin Wall |
| J7710HT | Socket, Impact 3/8" DR 5/16" Deep Thin Wall |
| J7712HT | Socket, Impact 3/8" DR 3/8" Deep Thin Wall |
| J7714HT | Socket, Impact 3/8" DR 7/16" Deep Thin Wall |
| J7716HT | Socket, Impact 3/8" DR 1/2" Deep Thin Wall |
| J7718HT | Socket, Impact 3/8" DR 9/16" Deep Thin Wall |
| J7720HT | Socket, Impact 3/8" DR 5/8" Deep Thin Wall |
| J7722HT | Socket, Impact 3/8" DR 11/16" Deep Thin Wall |
| J7724HT | Socket, Impact 3/8" DR 3/4" Deep Thin Wall |
| J7008MHT | Socket, Impact 3/8" DR 8 mm Deep Thin Wall |
| J7009MHT | Socket, Impact 3/8" DR 9 mm Deep Thin Wall |
| J7010MHT | Socket, Impact 3/8" DR 10 mm Deep Thin Wall |
| J7011MHT | Socket, Impact 3/8" DR 11 mm Deep Thin Wall |
| J7012MHT | Socket, Impact 3/8" DR 12 mm Deep Thin Wall |
| J7013MHT | Socket, Impact 3/8" DR 13 mm Deep Thin Wall |
| J7014MHT | Socket, Impact 3/8" DR 14 mm Deep Thin Wall |
| J7015MHT | Socket, Impact 3/8" DR 15 mm Deep Thin Wall |
| J7016MHT | Socket, Impact 3/8" DR 16 mm Deep Thin Wall |
| J7017MHT | Socket, Impact 3/8" DR 17 mm Deep Thin Wall |
| J7018MHT | Socket, Impact 3/8" DR 18 mm Deep Thin Wall |
| J7019MHT | Socket, Impact 3/8" DR 19 mm Deep Thin Wall |
| J7312HT | Socket, Impact 1/2" DR 3/8" Deep Thin Wall |
| J7314HT | Socket, Impact 1/2" DR 7/16" Deep Thin Wall |
| J7310MHT | Socket, Impact 1/2" DR 10 mm Deep Thin Wall |
| J7311MHT | Socket, Impact 1/2" DR 11 mm Deep Thin Wall |
| J7312MHT | Socket, Impact 1/2" DR 12 mm Deep Thin Wall |
| J7313MHT | Socket, Impact 1/2" DR 13 mm Deep Thin Wall |
| J74411/4 | Socket, Impact Hex Bit 1/2" DR 1/4" |
| J74413/8 | Socket, Impact Hex Bit 1/2" DR 3/8" |

(CONTINUED ON NEXT PAGE)

1258 PC MASTER TECHNICIAN MAINTENANCE SET (CONTINUED)

Product #: JCS-1258MAS



| Contents | Description | Contents | Description |
|-----------|--|----------|---|
| J74415/16 | Socket, Impact Hex Bit 1/2" DR 5/16" | 68-768 | Tap and Die, 76 PC Set |
| J74415/8 | Socket, Impact Hex Bit 1/2" DR 5/8" | 33-725 | Tape Rule, FatMax® 1-1/4" x 25' |
| J74417/16 | Socket, Impact Hex Bit 1/2" DR 7/16" | 33-212 | Tape Rule, Stanley® Powerlock® with Metal Case 1/2" X 12' |
| J74411/2 | Socket, Impact Hex Bit 1/2" DR 1/2" | J350 | Tubing Cutter |
| J74419/16 | Socket, Impact Hex Bit 1/2" DR 9/16" | J351 | Tubing Flaring Tool |
| J4770TA | Socket, Universal 1/4" DR 7/32" 12 PT | 55-515 | Wonder Bar® 13-3/8" |
| J4771TA | Socket, Universal 1/4" DR 1/4" 12 PT | J706 | Wrench, Adjustable 6" |
| J4777TA | Socket, Universal 1/4" DR 9/32" 12 PT | J708 | Wrench, Adjustable 8" |
| J4772TA | Socket, Universal 1/4" DR 5/16" 12 PT | J710 | Wrench, Adjustable 10" |
| J4778TA | Socket, Universal 1/4" DR 11/32" 12 PT | J712 | Wrench, Adjustable 12" |
| J4773TA | Socket, Universal 1/4" DR 3/8" 12 PT | J715 | Wrench, Adjustable 15" |
| J4774TA | Socket, Universal 1/4" DR 7/16" 12 PT | J3314 | Wrench, Angle 7/32" |
| J4775TA | Socket, Universal 1/4" DR 1/2" 2 PT | J3315 | Wrench, Angle 15/64" |
| J4776TA | Socket, Universal 1/4" DR 9/16" 12 PT | J3316 | Wrench, Angle 1/4" |
| J48055AM | Socket, Universal 1/4" DR 5.5 mm 6 PT | J3318 | Wrench, Angle 9/32" |
| J4805AM | Socket, Universal 1/4" DR 5 mm 6 PT | J3320 | Wrench, Angle 5/16" |
| J4806AM | Socket, Universal 1/4" DR 6 mm 6 PT | J3322 | Wrench, Angle 11/32" |
| J4807AM | Socket, Universal 1/4" DR 7 mm 6 PT | J3324 | Wrench, Angle 3/8" |
| J4808AM | Socket, Universal 1/4" DR 8 mm 6 PT | J3328 | Wrench, Angle 7/16" |
| J4809AM | Socket, Universal 1/4" DR 9 mm 6 PT | J3112 | Wrench, Angle 3/8" |
| J4810AM | Socket, Universal 1/4" DR 10 mm 6 PT | J3114 | Wrench, Angle 7/16" |
| J4811AM | Socket, Universal 1/4" DR 11 mm 6 PT | J3332 | Wrench, Angle 1/2" |
| J4812AM | Socket, Universal 1/4" DR 12 mm 6 PT | J3116 | Wrench, Angle 1/2" |
| J4813AM | Socket, Universal 1/4" DR 13 mm 6 PT | J3118 | Wrench, Angle 9/16" |
| J4814AM | Socket, Universal 1/4" DR 14 mm 6 PT | J3120 | Wrench, Angle 5/8" |
| J4815AM | Socket, Universal 1/4" DR 15 mm 6 PT | J3122 | Wrench, Angle 11/16" |
| J5273HA | Socket, Universal 3/8" DR 3/8" 6 PT | J3124 | Wrench, Angle 3/4" |
| J5274HA | Socket, Universal 3/8" DR 7/16" 6 PT | J3126 | Wrench, Angle 13/16" |
| J5275HA | Socket, Universal 3/8" DR 1/2" 6 PT | J3128 | Wrench, Angle 7/8" |
| J5276HA | Socket, Universal 3/8" DR 9/16" 6 PT | J3130 | Wrench, Angle 15/16" |
| J5277HA | Socket, Universal 3/8" DR 5/8" 6 PT | J3132 | Wrench, Angle 1" |
| J5278HA | Socket, Universal 3/8" DR 11/16" 6 PT | J3134 | Wrench, Angle 1-1/16" |
| J5279HA | Socket, Universal 3/8" DR 3/4" 6 PT | J3136 | Wrench, Angle 1-1/8" |
| J5270HAM | Socket, Universal 3/8" DR 7 mm 6 PT | J3140 | Wrench, Angle 1-1/4" |
| J5273HAM | Socket, Universal 3/8" DR 10 mm 6 PT | J3109M | Wrench, Angle 9 mm |
| J5274HAM | Socket, Universal 3/8" DR 11 mm 6 PT | J3110M | Wrench, Angle 10 mm |
| J5275HAM | Socket, Universal 3/8" DR 12 mm 6 PT | J3111M | Wrench, Angle 11 mm |
| J5276HAM | Socket, Universal 3/8" DR 13 mm 6 PT | J3112M | Wrench, Angle 12 mm |
| J5277HAM | Socket, Universal 3/8" DR 14 mm 6 PT | J3113M | Wrench, Angle 13 mm |
| J5278HAM | Socket, Universal 3/8" DR 15 mm 6 PT | J3114M | Wrench, Angle 14 mm |
| J5279HAM | Socket, Universal 3/8" DR 16 mm 6 PT | J3115M | Wrench, Angle 15 mm |
| J5280HAM | Socket, Universal 3/8" DR 17 mm 6 PT | J3116M | Wrench, Angle 16 mm |
| J5281HAM | Socket, Universal 3/8" DR 18 mm 6 PT | J3117M | Wrench, Angle 17 mm |
| J5282HAM | Socket, Universal 3/8" DR 19 mm 6 PT | J3118M | Wrench, Angle 18 mm |
| J5273A | Socket, Universal 3/8" DR 3/8" 12 PT | J3119M | Wrench, Angle 19 mm |
| J5274A | Socket, Universal 3/8" DR 7/16" 12 PT | J3210 | Wrench, Angle 13/64" x 15/64" Short |
| J5275A | Socket, Universal 3/8" DR 1/2" 12 PT | J3215 | Wrench, Angle 7/32" x 1/4" Short |
| J5276A | Socket, Universal 3/8" DR 9/16" 12 PT | J3211 | Wrench, Angle 15/64" x 13/64" Short |
| J5277A | Socket, Universal 3/8" DR 5/8" 12 PT | J3216 | Wrench, Angle 1/4" x 7/32" Short |
| J5278A | Socket, Universal 3/8" DR 11/16" 12 PT | J3220 | Wrench, Angle 9/32" x 5/16" Short |
| J5279A | Socket, Universal 3/8" DR 3/4" 12 PT | J3221 | Wrench, Angle 5/16" x 9/32" Short |
| J5281AM | Socket, Universal 3/8" DR 18 mm 12 PT | J3225 | Wrench, Angle 11/32" x 3/8" Short |
| J5282AM | Socket, Universal 3/8" DR 19 mm 12 PT | J3226 | Wrench, Angle 3/8" x 11/32" Short |
| TR250 | Stapler / Brad Nailer, Heavy-Duty Aluminum | J1170 | Wrench, Box 5/16" x 3/8" 12 PT |
| TRA706T | Staples, Heavy-Duty 3/8" - 1,000 Pack | J1171 | Wrench, Box 7/16" x 1/2" 12 PT |





| Contents | Description |
|-----------------|--------------------------------------|
| J1172 | Wrench, Box 9/16" x 5/8" 12 PT |
| J1173 | Wrench, Box 11/16" x 3/4" 12 PT |
| J1174 | Wrench, Box 13/16" x 7/8" 12 PT |
| J1175 | Wrench, Box 15/16" x 1" 12 PT |
| J1176 | Wrench, Box 1-1/16" x 1-1/8" 12 PT |
| J1050M | Wrench, Box 6 x 7 mm 12 PT |
| J1051M | Wrench, Box 8 x 9 mm 12 PT |
| J1053M | Wrench, Box 10 x 11 mm 12 PT |
| J1057M | Wrench, Box 12 x 13 mm 12 PT |
| J1061M | Wrench, Box 14 x 15 mm 12 PT |
| J1064M | Wrench, Box 16 x 18 mm 12 PT |
| J1065M | Wrench, Box 17 x 19 mm 12 PT |
| J1072M | Wrench, Box 21 x 24 mm 12 PT |
| J1073M | Wrench, Box 22 x 24 mm 12 PT |
| J1077M | Wrench, Box 27 x 30 mm 12 PT |
| J1079M | Wrench, Box 30 x 32 mm 12 PT |
| J1120 | Wrench, Box 5/16" x 3/8" 12 PT Short |
| J1122 | Wrench, Box 3/8" x 7/16" 12 PT Short |
| J1126 | Wrench, Box 1/2" x 9/16" 12 PT Short |
| J1131 | Wrench, Box 5/8" x 3/4" 12 PT Short |
| J801 | Wrench, Chain |
| J1210A | Wrench, Combination 5/16" 12 PT |
| J1212ASD | Wrench, Combination 3/8" 12 PT |
| J1214ASD | Wrench, Combination 7/16" 12 PT |
| J1216ASD | Wrench, Combination 1/2" 12 PT |
| J1218ASD | Wrench, Combination 9/16" 12 PT |
| J1220ASD | Wrench, Combination 5/8" 12 PT |
| J1222ASD | Wrench, Combination 11/16" 12 PT |
| J1224ASD | Wrench, Combination 3/4" 12 PT |
| J1226ASD | Wrench, Combination 13/16" 12 PT |
| J1228ASD | Wrench, Combination 7/8" 12 PT |
| J1230ASD | Wrench, Combination 15/16" 12 PT |
| J1232ASD | Wrench, Combination 1" 12 PT |
| J1234ASD | Wrench, Combination 1-1/16" 12 PT |
| J1236ASD | Wrench, Combination 1-1/8" 12 PT |
| J1240ASD | Wrench, Combination 1-1/4" 12 PT |
| J1242 | Wrench, Combination 1-5/16" 12 PT |
| J1244 | Wrench, Combination 1-3/8" 12 PT |
| J1246 | Wrench, Combination 1-7/16" 12 PT |
| J1248 | Wrench, Combination 1-1/2" 12 PT |
| J1207MA | Wrench, Combination 7 mm 12 PT |
| J1208MA | Wrench, Combination 8 mm 12 PT |
| J1209MA | Wrench, Combination 9 mm 12 PT |
| J1210MASD | Wrench, Combination 10 mm 12 PT |
| J1211MASD | Wrench, Combination 11 mm 12 PT |
| J1212MASD | Wrench, Combination 12 mm 12 PT |
| J1213MASD | Wrench, Combination 13 mm 12 PT |
| J1214MASD | Wrench, Combination 14 mm 12 PT |
| J1215MASD | Wrench, Combination 15 mm 12 PT |
| J1216MASD | Wrench, Combination 16 mm 12 PT |
| J1217MASD | Wrench, Combination 17 mm 12 PT |
| J1218MASD | Wrench, Combination 18 mm 12 PT |
| J1219MASD | Wrench, Combination 19 mm 12 PT |
| J1220MASD | Wrench, Combination 20 mm 12 PT |
| J1221MASD | Wrench, Combination 21 mm 12 PT |
| J1222MASD | Wrench, Combination 22 mm 12 PT |
| J1223MASD | Wrench, Combination 23 mm 12 PT |
| J1224MASD | Wrench, Combination 24 mm 12 PT |

| Contents | Description |
|-----------------|---|
| J1204EF | Wrench, Combination 1/8" 6 PT Short |
| J1205EF | Wrench, Combination 5/32" 6 PT Short |
| J1206EF | Wrench, Combination 3/16" 6 PT Short |
| J1208EF | Wrench, Combination 1/4" 6 PT Short |
| J1209EF | Wrench, Combination 9/32" 6 PT Short |
| J1210EF | Wrench, Combination 5/16" 6 PT Short |
| J1211EF | Wrench, Combination 11/32" 6 PT Short |
| J1212EF | Wrench, Combination 3/8" 6 PT Short |
| J4912CF | Wrench, Crowfoot 3/8" DR 3/8" Open End |
| J4914CF | Wrench, Crowfoot 3/8" DR 7/16" Open End |
| J4916CF | Wrench, Crowfoot 3/8" DR 1/2" Open End |
| J4918CF | Wrench, Crowfoot 3/8" DR 9/16" Open End |
| J4920CF | Wrench, Crowfoot 3/8" DR 5/8" Open End |
| J4922CF | Wrench, Crowfoot 3/8" DR 11/16" Open End |
| J4924CF | Wrench, Crowfoot 3/8" DR 3/4" Open End |
| J4926CF | Wrench, Crowfoot 3/8" DR 13/16" Open End |
| J4928CF | Wrench, Crowfoot 3/8" DR 7/8" Open End |
| J4909MCF | Wrench, Crowfoot 3/8" DR 9 mm Open End |
| J4910MCF | Wrench, Crowfoot 3/8" DR 10 mm Open End |
| J4911MCF | Wrench, Crowfoot 3/8" DR 11 mm Open End |
| J4912MCF | Wrench, Crowfoot 3/8" DR 12 mm Open End |
| J4913MCF | Wrench, Crowfoot 3/8" DR 13 mm Open End |
| J4914MCF | Wrench, Crowfoot 3/8" DR 14 mm Open End |
| J4915MCF | Wrench, Crowfoot 3/8" DR 15 mm Open End |
| J4916MCF | Wrench, Crowfoot 3/8" DR 16 mm Open End |
| J4917MCF | Wrench, Crowfoot 3/8" DR 17 mm Open End |
| J4918MCF | Wrench, Crowfoot 3/8" DR 18 mm Open End |
| J4919MCF | Wrench, Crowfoot 3/8" DR 19 mm Open End |
| J4920MCF | Wrench, Crowfoot 3/8" DR 20 mm Open End |
| J4921MCF | Wrench, Crowfoot 3/8" DR 21 mm Open End |
| J4922MCF | Wrench, Crowfoot 3/8" DR 22 mm Open End |
| J4923MCF | Wrench, Crowfoot 3/8" DR 23 mm Open End |
| J4924MCF | Wrench, Crowfoot 3/8" DR 24 mm Open End |
| J5336FL | Wrench, Crowfoot 1/2" DR 1-1/8" |
| J5338FL | Wrench, Crowfoot 1/2" DR 1-3/16" |
| J5340FL | Wrench, Crowfoot 1/2" DR 1-1/4" |
| J5342FL | Wrench, Crowfoot 1/2" DR 1-5/16" |
| J5344FL | Wrench, Crowfoot 1/2" DR 1-3/8" |
| J5346FL | Wrench, Crowfoot 1/2" DR 1-7/16" |
| J5348FL | Wrench, Crowfoot 1/2" DR 1-1/2" |
| J5350FL | Wrench, Crowfoot 1/2" DR 1-9/16" |
| J5352FL | Wrench, Crowfoot 1/2" DR 1-5/8" |
| J5354FL | Wrench, Crowfoot 1/2" DR 1-11/16" |
| J5356FL | Wrench, Crowfoot 1/2" DR 1-3/4" |
| J5358FL | Wrench, Crowfoot 1/2" DR 1-13/16" |
| J5360FL | Wrench, Crowfoot 1/2" DR 1-7/8" |
| J5362FL | Wrench, Crowfoot 1/2" DR 1-15/16" |
| J5364FL | Wrench, Crowfoot 1/2" DR 2" |
| J3751 | Wrench, Flare Nut Combination 3/8" 6 PT |
| J3752 | Wrench, Flare Nut Combination 7/16" 6 PT |
| J3753 | Wrench, Flare Nut Combination 1/2" 6 PT |
| J3754 | Wrench, Flare Nut Combination 9/16" 6 PT |
| J3755 | Wrench, Flare Nut Combination 5/8" 6 PT |
| J3756 | Wrench, Flare Nut Combination 11/16" 6 PT |
| J3757 | Wrench, Flare Nut Combination 3/4" 6 PT |
| J3812 | Wrench, Flare Nut Ratcheting 3/8" |
| J3814 | Wrench, Flare Nut Ratcheting 7/16" |
| J3816 | Wrench, Flare Nut Ratcheting 1/2" |

(CONTINUED ON NEXT PAGE)



1258 PC MASTER TECHNICIAN MAINTENANCE SET (CONTINUED)

Product #: **JCS-1258MAS**



| Contents | Description | Contents | Description |
|----------|---|-----------|--|
| J3818 | Wrench, Flare Nut Ratcheting 9/16" | J5342CF | Wrench, Open End Crowfoot 1/2" DR 1-5/16" |
| J3820 | Wrench, Flare Nut Ratcheting 5/8" | J5344CF | Wrench, Open End Crowfoot 1/2" DR 1-3/8" |
| J3822 | Wrench, Flare Nut Ratcheting 11/16" | J5346CF | Wrench, Open End Crowfoot 1/2" DR 1-7/16" |
| J3824 | Wrench, Flare Nut Ratcheting 3/4" | J5348CF | Wrench, Open End Crowfoot 1/2" DR 1-1/2" |
| J3707M | Wrench, Flare Nut 7 mm x 8 mm | J5350CF | Wrench, Open End Crowfoot 1/2" DR 1-9/16" |
| J3709M | Wrench, Flare Nut 9 mm x 11 mm | J5352CF | Wrench, Open End Crowfoot 1/2" DR 1-5/8" |
| J3710M | Wrench, Flare Nut 10 mm x 12 mm | J5354CF | Wrench, Open End Crowfoot 1/2" DR 1-11/16" |
| J3713M | Wrench, Flare Nut 13 mm x 14 mm | J5356CF | Wrench, Open End Crowfoot 1/2" DR 1-3/4" |
| J3715M | Wrench, Flare Nut 15 mm x 17 mm | J5358CF | Wrench, Open End Crowfoot 1/2" DR 1-13/16" |
| J1725 | Wrench, Obstruction 7/16" x 1/2" | J5360CF | Wrench, Open End Crowfoot 1/2" DR 1-7/8" |
| J1730 | Wrench, Obstruction 9/16" x 5/8" | J5364CF | Wrench, Open End Crowfoot 1/2" DR 2" |
| J1731 | Wrench, Obstruction 5/8" x 3/4" | J5368CF | Wrench, Open End Crowfoot 1/2" DR 2-1/8" |
| J3018 | Wrench, Open End 1/4" x 5/16" | J5372CF | Wrench, Open End Crowfoot 1/2" DR 2-1/4" |
| J3020 | Wrench, Open End 3/8" x 5/16" | J5376CF | Wrench, Open End Crowfoot 1/2" DR 2-3/8" |
| J3025 | Wrench, Open End 7/16" x 1/2" | J5378CF | Wrench, Open End Crowfoot 1/2" DR 2-7/16" |
| J3026 | Wrench, Open End 1/2" x 9/16" | J5380CF | Wrench, Open End Crowfoot 1/2" DR 2-1/2" |
| J3030 | Wrench, Open End 9/16" x 5/8" | J810HD | Wrench, Pipe Heavy-Duty 10" |
| J3031 | Wrench, Open End 5/8" x 3/4" | J814HD | Wrench, Pipe Heavy-Duty 14" |
| J3035 | Wrench, Open End 11/16" x 3/4" | J818HD | Wrench, Pipe Heavy-Duty 18" |
| J3040 | Wrench, Open End 13/16" x 7/8" | J1191T-A | Wrench, Ratcheting Box 1/4" x 5/16" 12 PT |
| J3045 | Wrench, Open End 15/16" x 1" | J1192T-A | Wrench, Ratcheting Box 3/8" x 7/16" 12 PT |
| J3050 | Wrench, Open End 1-1/16" x 1-1/8" | J1193T-A | Wrench, Ratcheting Box 1/2" x 9/16" 12 PT |
| J30607 | Wrench, Open End 6 mm x 7 mm | J1194-A | Wrench, Ratcheting Box 5/8" x 11/16" 12 PT |
| J30809 | Wrench, Open End 8 mm x 9 mm | J1195-A | Wrench, Ratcheting Box 3/4" x 7/8" 12 PT |
| J31011 | Wrench, Open End 10 mm x 11 mm | J1191M-A | Wrench, Ratcheting Box 7 mm x 8 mm |
| J31213 | Wrench, Open End 12 mm x 13 mm | J1192M-A | Wrench, Ratcheting Box 9 mm x 10 mm |
| J31415 | Wrench, Open End 14 mm x 15 mm | J1193MA-A | Wrench, Ratcheting Box 11 mm x 12 mm |
| J31617 | Wrench, Open End 16 mm x 17 mm | J1194MA-A | Wrench, Ratcheting Box 13 mm x 14 mm |
| J31819 | Wrench, Open End 18 mm x 19 mm | J1195M-A | Wrench, Ratcheting Box 15 mm x 17 mm |
| J32022 | Wrench, Open End 20 mm x 22 mm | J1270-12 | Wrench, Swivel Combination 3/8" 12 PT |
| J32123 | Wrench, Open End 21 mm x 23 mm | J1270-14 | Wrench, Swivel Combination 7/16" 12 PT |
| J32426 | Wrench, Open End 24 mm x 26 mm | J1270-16 | Wrench, Swivel Combination 1/2" 12 PT |
| J5330CF | Wrench, Open End Crowfoot 1/2" DR 15/16" | J1270-18 | Wrench, Swivel Combination 9/16" 12 PT |
| J5332CF | Wrench, Open End Crowfoot 1/2" DR 1" | J1270-20 | Wrench, Swivel Combination 5/8" 12 PT |
| J5334CF | Wrench, Open End Crowfoot 1/2" DR 1-1/16" | J1270-22 | Wrench, Swivel Combination 11/16" 12 PT |
| J5336CF | Wrench, Open End Crowfoot 1/2" DR 1-1/8" | J1270-24 | Wrench, Swivel Combination 3/4" 12 PT |
| J5338CF | Wrench, Open End Crowfoot 1/2" DR 1-3/16" | J6064C | Wrench, Torque 3/8" DR 40-200 in-lbs |
| J5340CF | Wrench, Open End Crowfoot 1/2" DR 1-1/4" | J6014C | Wrench, Torque 1/2" DR 50-250 ft-lbs |



1258 PC MASTER TECHNICIAN MAINTENANCE SET WITH WORKSTATION J456646-12RD

Product #: JCS-1258MASBX1

- › 1258 Pieces.
- › 1/4", 3/8", 1/2", 3/4" Drive Tools.
- › Designed for fastener sizes 1/16" - 2-3/8", 2 mm - 26 mm.
- › Contains: 642 Sockets and Accessories, 238 Wrenches, 50 Striking and Struck Tools, 33 Pliers, 63 Screwdrivers, 223 Miscellaneous Tools.
- › Modules contained: JCS-MAS-1, JCS-MAS-2, JCS-MAS-3, JCS-MAS-4, JCS-MAS-5, JCS-MAS-6, JCS-MAS-7.
- › Weight: 1355.0 lbs.



Representative Image; Contents May Differ

1258 PC MASTER TECHNICIAN MAINTENANCE SET WITH WORKSTATION J445442-14RD AND TOP CHEST J445419-12RD

Product #: JCS-1258MASBX2

- › 1258 Pieces.
- › 1/4", 3/8", 1/2", 3/4" Drive Tools.
- › Designed for fastener sizes 1/16" - 2-3/8", 2 mm - 26 mm.
- › Contains: 642 Sockets and Accessories, 238 Wrenches, 50 Striking and Struck Tools, 33 Pliers, 63 Screwdrivers, 223 Miscellaneous Tools.
- › Modules contained: JCS-MAS-1, JCS-MAS-2, JCS-MAS-3, JCS-MAS-4, JCS-MAS-5, JCS-MAS-6, JCS-MAS-7.
- › Weight: 1229.0 lbs.



Representative Image; Contents May Differ

Made in USA accurate at time of printing, consult www.protoindustrial.com for updated information.

 Made in USA  Made in USA with global components

PROTO



1046 PC MASTER TECHNICIAN MAINTENANCE SET

Product #: JCS-1046MAS



- › 1046 Pieces.
- › 1/4", 3/8", 1/2", 3/4" Drive Tools.
- › Designed for fastener sizes 1/16" - 2-3/8", 2 mm - 24 mm.
- › Tools only.
- › Contains: 469 Sockets and Accessories, 240 Wrenches, 42 Striking and Struck Tools, 32 Pliers, 111 Screwdrivers, 152 Miscellaneous Tools
- › Modules contained: JCS-MAS-1, JCS-MAS-2, JCS-MAS-3, JCS-MAS-4, JCS-MAS-5, JCS-MAS-6, JCS-MOD1046.
- › Enhanced version of Proto® J99950 Master Technician Maintenance Set.
- › Weight: 513.0 lbs.



Representative Image; Contents May Differ

| Contents | Description |
|-----------|-------------------------------------|
| J4770A | Adapter, Universal Joint 1/4" DR |
| J5270A | Adapter, Universal Joint 3/8" DR |
| J5470A | Adapter, Universal Joint 1/2" DR |
| J5670 | Adapter, Universal Joint 3/4" DR |
| J2126 | Bar, 12" Long 1/2" Tip |
| J2130 | Bar, 16" Long 5/8" Tip |
| J2120 | Bar, Pry Aligning 18" |
| J2142 | Bar, Pry Aligning 18" |
| J2124 | Bar, Pry Aligning 24" |
| J2146 | Bar, Pry Aligning 28" |
| 9000-10 | Bit, 1/4" x 1" |
| J61906 | Bit, 38 PC Insert Set |
| 9000-8 | Bit, for P1 1/4" x 1" |
| 9000-9 | Bit, for P2 1/4" x 1" |
| J6931 | Bit, Holder Power 3/8" DR 1/4" Hex |
| J6931 | Bit, Holder Power 3/8" DR 1/4" Hex |
| J6930 | Bit, Holder Power 3/8" DR 5/16" Hex |
| J6930 | Bit, Holder Power 3/8" DR 5/16" Hex |
| J60002 | Bit, Insert #1 Phillips® 1/4" Hex |
| J60050 | Bit, Insert #1 Phillips® 5/16" Hex |
| J60050 | Bit, Insert #1 Phillips® 5/16" Hex |
| J60008 | Bit, Insert #2 Phillips® 1/4" Hex |
| J60052 | Bit, Insert #2 Phillips® 5/16" Hex |
| J60052 | Bit, Insert #2 Phillips® 5/16" Hex |
| J60020 | Bit, Insert #3 Phillips® 1/4" Hex |
| J60054 | Bit, Insert #3 Phillips® 5/16" Hex |
| J60054 | Bit, Insert #3 Phillips® 5/16" Hex |
| J60202 | Bit, Insert 3/16" Slotted 1/4" Hex |
| J60208 | Bit, Insert 9/32" Slotted 1/4" Hex |
| J60256 | Bit, Insert 10F-12R Slot 5/16" Hex |
| J60262 | Bit, Insert 14F-16R Slot 5/16" Hex |
| 9000-7 | Bit, Insert Slotted 1/4" x 7/8" |
| 9000-6 | Bit, Insert Slotted 3/16" #4 |
| 9000-11 | Bit, Insert Slotted 5/16" x 1-1/2" |
| 9000-12 | Bit, Insert Slotted 5/16" x 1-1/2" |
| J9969-NA | Box, General Purpose with Tray |
| J404 | C-Clamps, Capacity 0"-4", 2 Each |
| J404 | C-Clamps, Capacity 0"-4", 2 Each |
| J86A7/8X8 | Chisel, Cold 1" |
| J86A7/16 | Chisel, Cold 1/2" |
| J86A3/16 | Chisel, Cold 1/4" |
| J86A5/8 | Chisel, Cold 3/4" |
| J86A5/16 | Chisel, Cold 3/8" |
| J86A1/4 | Chisel, Cold 5/16" |
| J86A1/2 | Chisel, Cold 5/8" |
| J86A3/4X8 | Chisel, Cold 7/8" |
| J86A1X8 | Chisel, Cold 1-3/16" |
| J4769 | Driver, 1/4" DR |
| J9521 | Extractor, Screw 1/8" |





| Contents | Description |
|-----------|---|
| J9522 | Extractor, Screw 3/16" |
| J9523 | Extractor, Screw 15/64" |
| J9524 | Extractor, Screw 5/16" |
| J9525 | Extractor, Screw 3/8" |
| J9525B | Extractor, Screw 15/32" |
| J9526 | Extractor, Screw 9/16" |
| J9527 | Extractor, Screw 21/32" |
| J9528 | Extractor, Screw 13/16" |
| J9529 | Extractor, Screw 1-1/16" |
| J4759 | Extension, 1/4" DR 2" |
| J4760 | Extension, 1/4" DR 3" |
| J4761 | Extension, 1/4" DR 6" |
| J4761L | Extension, Locking 1/4" DR 6" |
| J5260 | Extension, 3/8" DR 3" |
| J5260-06 | Extension, 3/8" DR 6" |
| J5260-06L | Extension, Locking 3/8" DR 6" |
| J5262 | Extension, 3/8" DR 12" |
| J5460 | Extension, 1/2" DR 2-1/2" |
| J5461 | Extension, 1/2" DR 5" |
| J5463 | Extension, 1/2" DR 10" |
| J5463L | Extension, Locking 1/2" DR 10" |
| J5660 | Extension, 3/4" DR 4" |
| J5661 | Extension, 3/4" DR 8" |
| J5663 | Extension, 3/4" DR 16" |
| J4765 | Extension, Flex 1/4" DR 6-1/4" |
| J5268 | Extension, Flex 3/8" DR 8" |
| J7180P | Extension, Impact 1/2" DR 2" |
| J7181P | Extension, Impact 1/2" DR 5" |
| J5460W | Extension, Wobble 1/2" DR 2" |
| J4760W | Extension, Wobble 1/4" DR 3" |
| J5260W | Extension, Wobble 3/8" DR 3" |
| J5260-06W | Extension, Wobble 3/8" DR 6" |
| J5261W | Extension, Wobble 3/8" DR 8" |
| J0000 | Feeler Gauge, 10 Blade Ignition Set |
| J2302 | File, Ignition PT |
| 15-265 | Hacksaw, 3-7/8" |
| J1430-HB | Hammer Head |
| J1308PD | Hammer, Ball Pein 8 oz. |
| J1316PD | Hammer, Ball Pein 16 oz. |
| J1332PD | Hammer, Ball Pein 32 oz. |
| 57-532 | Hammer, Compo-Cast® 21 oz. |
| 57-534 | Hammer, Compo-Cast® 52 oz. |
| JSF150 | Hammer, Soft: Face without Tips SF15 |
| JSF15XH | Hammer, Tip, Surface Protective 1-1/2" Extra Hard |
| JSF15H | Hammer, Tip, Surface Protective 1-1/2" Hard |
| JSF15M | Hammer, Tip 1-1/2" Medium |
| JSF15MH | Hammer, Tip 1-1/2" Medium Hard |
| JSF15S | Hammer, Tip 1-1/2" Soft |
| JSF15SS | Hammer, Tip 1-1/2" Super Soft |
| JSF15T | Hammer, Tip 1-1/2" Tough |
| J4780G | Handle, Speed 1/4" DR |
| J5280G | Handle, Speed 3/8" DR |
| J5480G | Handle, Speed 1/2" DR |
| J4766 | Handle, Hinge 1/4" DR 5-3/4" |
| J5265 | Handle, Hinge 3/8" DR 8-1/2" |
| J5468 | Handle, Hinge 1/2" DR |
| J5668 | Handle, Hinge 3/4" DR 20" |
| J4785 | Handle, Sliding T 1/4" DR |

| Contents | Description |
|----------|---|
| J5285 | Handle, Sliding T 3/8" DR |
| J5485 | Handle, Sliding T 1/2" DR |
| J5685 | Handle, Sliding T 3/4" DR |
| J4984 | Hex Key, 9 PC Metric Set |
| J4980 | Hex Key, 13 PC Standard Set |
| J2108 | Holder, Punch and Chisel |
| J7099 | Impact, Hand Driver 3/8" |
| J95218 | Knife, Folding Blade |
| J18545B | Knife, Lockback 5" |
| 10-189C | Knife, Self-Retracting Utility |
| 10-099 | Knife, Stanley® Classic 99® Retractable Blade Utility |
| 42-465 | Level, Aluminum Torpedo Level (Mag) |
| J1368 | Mallet, Rubber |
| J2371 | Mirror, Inspect Oval 1" x 2" |
| J2373 | Mirror, Rectangular Telescoping 2-1/8" |
| J9206 | Nut Driver, 3/16" |
| J9207 | Nut Driver, 7/32" |
| J9208 | Nut Driver, 1/4" |
| J9209 | Nut Driver, 9/32" |
| J9210 | Nut Driver, 5/16" |
| J9211 | Nut Driver, 11/32" |
| J9212 | Nut Driver, 3/8" |
| J9214 | Nut Driver 7/16" |
| J9216 | Nut Driver, 1/2" |
| J9218 | Nut Driver, 9/16" |
| J9220 | Nut Driver, 5/8" |
| J9204M | Nut Driver, 4 mm |
| J9205M | Nut Driver, 5 mm |
| J92055M | Nut Driver, 5.5 mm |
| J9206M | Nut Driver, 6 mm |
| J9207M | Nut Driver, 7 mm |
| J9208M | Nut Driver, 8 mm |
| J9209M | Nut Driver, 9 mm |
| J9210M | Nut Driver, 10 mm |
| J9211M | Nut Driver, 11 mm |
| J9213M | Nut Driver, 13 mm |
| J9214M | Nut Driver, 14 mm |
| 82-115 | Pick and Hook, 4 PC Set |
| J206G | Pliers, Diagonal Cutting with Grip 6-1/16" |
| J209G | Pliers, Diagonal Cutting with Grip 7-5/16" |
| J227G | Pliers, Duckbill with Grip 7-25/32" |
| J272G | Pliers, End Cutting High Leverage 8-1/4" |
| J252G | Pliers, Hose Clamp with Grip 7-3/4" |
| J235 | Pliers, Ignition with Grip 4-1/16" |
| J235 | Pliers, Ignition with Grip 4-1/16" |
| J268G | Pliers, Lineman's with Grip 8-5/8" |
| J292NC | Pliers, Locking Curved 10" |
| J286LNXL | Pliers, Locking Mini Long Nose 6-29/32" |
| J291NC | Pliers, Locking Straight 7" |
| J225G | Pliers, Needle-Nose Bent Nose 6-5/16" |
| J222G | Pliers, Needle-Nose Long Thin 6-1/16" |
| J226G | Pliers, Needle-Nose with Cutter 6-5/8" |
| J360A | Pliers, 6 PC Retaining Ring Set |
| J276G | Pliers, Slip-Joint with Grip 6-9/16" |
| J278G | Pliers, Slip-Joint with Grip 8-1/16" |
| J261SG | Pliers, Tongue and Groove 5" with Grip |
| J262SG | Pliers, Tongue and Groove 6-1/2" with Grip |
| J260SG | Pliers, Tongue and Groove 10-3/16" with Grip |

(CONTINUED ON NEXT PAGE)

1046 PC MASTER TECHNICIAN MAINTENANCE SET (CONTINUED)

Product #: JCS-1046MAS



| Contents | Description | Contents | Description |
|----------|---|--------------|---|
| J265SG | Pliers, Tongue and Groove 16" with Grip | J4040-11 | Puller, Step Plate 2" |
| J298 | Pliers, Wire Strippers 8-1/4" | J4040-12 | Puller, Step Plate 2-1/8" |
| J4280B | Puller, Blind Bearing Coll | J4040-14 | Puller, Step Plate 2-3/8" |
| J4280S | Puller, Blind Bearing Screw | J4040-13 | Puller, Step Plate 2-1/4" |
| J4005C | Puller, Cap Screw | J4012T | Puller, Tip Detachable |
| J4028 | Puller, Cap Screw | J4022T | Puller, Tip Detachable Standard |
| J2306 | Puller, Cotter Pin Tool | J4250B | Puller, Yoke 2 Way Acme Th |
| J4226CA | Puller, Crossarm 2 Way | J4255B | Puller, Yoke 3 Way Jaw ACM |
| J4227CA | Puller, Crossarm 3 Way | J413/8 | Punch, Center 3/8" |
| J4208CA | Puller, Crossarm 6 Ton 2 Way | J411/2 | Punch, Center 1/2" |
| J4260R | Puller, Handle T-Rod Acme | J965/16 | Punch, Drift 1/8" |
| J4026A | Puller, Jaw 6 Ton | J963/8 | Punch, Drift 3/16" |
| J4209JB | Puller, Jaw 6 Ton Block | J961/2 | Punch, Drift 1/4" |
| J4027 | Puller, Jaw 6 Ton Narrow | J471/4X3/32 | Punch, Pin 3/32" |
| J4210RJ | Puller, Jaw 6 Ton Reversible | J475/16X1/8 | Punch, Pin 1/8" |
| J4229JB | Puller, Jaw 10 Ton Block | J475/16X5/32 | Punch, Pin 5/32" |
| J4018 | Puller, Jaw 10 Ton Cap Screw | J473/8X3/16 | Punch, Pin 3/16" |
| J4016A | Puller, Jaw 10 Ton Dual-Reach | J477/16X7/32 | Punch, Pin 7/32" |
| J4017 | Puller, Jaw 10 Ton Narrow | J471/2X1/4 | Punch, Pin 1/4" |
| J4230RJ | Puller, Jaw 10 Ton Reversible | J445/16 | Punch, Prick |
| J4209LS | Puller, Jaw Block Lock Screw | J501/4 | Punch, Starting 3/32" |
| J4229LS | Puller, Jaw Block Lock Screw | J505/16 | Punch, Starting 1/8" |
| J4056-2 | Puller, Jaw Inside 2 Reach | J503/8 | Punch, Starting 3/16" |
| J4256S | Puller, Jaw Inside Hook | J507/16 | Punch, Starting 7/32" |
| J4056-4 | Puller, Jaw Reversible 4 R | J501/2 | Punch, Starting 1/4" |
| J4056-6 | Puller, Jaw Reversible 6 R | J4749 | Ratchet, 1/4" DR |
| J4250N | Puller, Nut Adjustable Reversible | J5249 | Ratchet, 3/8" DR |
| J4331N | Puller, Nut Hex | J5449 | Ratchet, 1/2" DR |
| J4333N | Puller, Nut Hex | J5450 | Ratchet, 1/2" DR (Long Handle) |
| J4056PN | Puller, Pin Pivot | J5649 | Ratchet, 3/4" DR |
| J4277B | Puller, Rear Axle Flange F | J5247 | Ratchet Adapter 3/8" DR 2-1/16" |
| J4275R | Puller, Rod Slide Acme Threader | J5447 | Ratchet Adapter 1/2" DR 2-21/32" |
| J4333AR | Puller, Rod Threader 3/4"-1" | J5257F | Ratchet, 3/8" DR Flex-Head 2-1/16" |
| J4331R | Puller, Screw Cap | J5457F | Ratchet, 1/2" DR Flex-Head 17-3/32" |
| J4205E | Puller, Screw Cap | J2375 | Retrieval Tool, Pocket Magnetic |
| J4331R | Puller, Screw Cap | 28-240 | Scraper, Flexible Nylon 1-1/4" |
| J4205S | Puller, Screw Forcing Acme | 28-540 | Scraper, Flexible 1-1/4" Wood Handle |
| J4225S | Puller, Screw Forcing Acme | J2338 | Scrapers, Gasket and Carbon |
| J4331P | Puller, Separator Plate | J2336 | Scrapers, Gasket and Carbon |
| J4333P | Puller, Separator Plate | J9884 | Screw Starter, Phillips® Tip |
| J4260H | Puller, Slide Hammer 2-1/2" | J9853 | Screw Starter, Standard Tip |
| J4055H | Puller, Slide Hammer 5 lbs. | J9853 | Screw Starter, Standard Tip |
| J4205B | Puller, Slotted Cross Arm | 66-039 | Screwdriver, 6 PC Stanley® Jewelers Precision Set |
| J4206SC | Puller, Slotted Cross Arm | J88203 | Screwdriver, Slotted Cabinet, Round 1/8" x 3" |
| J4011S | Puller, Spring Clip | J88204 | Screwdriver, Slotted Cabinet, Round 1/8" x 4" |
| J4021S | Puller, Spring Clip | J88208 | Screwdriver, Slotted Cabinet, Round 1/8" x 8" |
| J4040-1 | Puller, Step Plate 3/4" | J88214 | Screwdriver, Slotted Cabinet, Round 3/16" x 4" |
| J4040-2 | Puller, Step Plate 7/8" | J88218 | Screwdriver, Slotted Cabinet, Round 3/16" x 8" |
| J4040-3 | Puller, Step Plate 1" | J88393 | Screwdriver, Phillips® #0 |
| J4040-4 | Puller, Step Plate 1-1/8" | J88313 | Screwdriver, Phillips® #1 |
| J4040-5 | Puller, Step Plate 1-1/4" | J88318 | Screwdriver, Phillips® #1 |
| J4040-6 | Puller, Step Plate 1-3/8" | J88322 | Screwdriver, Phillips® #2 |
| J4040-7 | Puller, Step Plate 1-1/2" | J88324 | Screwdriver, Phillips® #2 |
| J4040-8 | Puller, Step Plate 1-5/8" | J88328 | Screwdriver, Phillips® #2 |
| J4040-9 | Puller, Step Plate 1-3/4" | J88336 | Screwdriver, Phillips® #3 |
| J4040-10 | Puller, Step Plate 1-7/8" | J88348 | Screwdriver, Phillips® #4 |





| Contents | Description |
|-----------------|---|
| J88102 | Screwdriver, Slotted Keystone, Square 1/4" x 2" |
| J88104 | Screwdriver, Slotted Keystone, Square 1/4" x 4" |
| J88106 | Screwdriver, Slotted Keystone, Square 1/4" x 6" |
| J88108 | Screwdriver, Slotted Keystone, Square 1/4" x 8" |
| J88112 | Screwdriver, Slotted Keystone, Square 1/4" x 12" |
| J88002 | Screwdriver, Slotted Keystone, Round 1/4" x 1-1/2" |
| 66-101 | Screwdriver, Stanley® 100 PLUS® Standard Slotted Tip Pocket 1/8" x 2" |
| J9320 | Set, 11 PC Screwdriver Magnetic Ratchet |
| J307 | Snip, Duckbill 7" |
| J334 | Snip, Combination 14" |
| J322 | Snips, Straight 12-3/4" |
| J303S | Snips, Aviation Straight |
| J308 | Snips, Miniature |
| J4706 | Socket, 1/4" DR 3/16" 6 PT |
| J4707 | Socket, 1/4" DR 7/32" 6 PT |
| J4708 | Socket, 1/4" DR 1/4" 6 PT |
| J4709 | Socket, 1/4" DR 9/32" 6 PT |
| J4711 | Socket, 1/4" DR 11/32" 6 PT |
| J4710 | Socket, 1/4" DR 5/16" 6 PT |
| J4712 | Socket, 1/4" DR 3/8" 6 PT |
| J4714 | Socket, 1/4" DR 7/16" 6 PT |
| J4716 | Socket, 1/4" DR 1/2" 6 PT |
| J4718 | Socket, 1/4" DR 9/16" 6 PT |
| J4704M | Socket, 1/4" DR 4 mm 6 PT |
| J4705M | Socket, 1/4" DR 5 mm 6 PT |
| J47055M | Socket, 1/4" DR 5.5 mm 6 PT |
| J4706M | Socket, 1/4" DR 6 mm 6 PT |
| J4707M | Socket, 1/4" DR 7 mm 6 PT |
| J4708M | Socket, 1/4" DR 8 mm 6 PT |
| J4709M | Socket, 1/4" DR 9 mm 6 PT |
| J4710M | Socket, 1/4" DR 10 mm 6 PT |
| J4711M | Socket, 1/4" DR 11 mm 6 PT |
| J4712M | Socket, 1/4" DR 12 mm 6 PT |
| J4713M | Socket, 1/4" DR 13 mm 6 PT |
| J4714M | Socket, 1/4" DR 14 mm 6 PT |
| J4706L | Socket, 1/4" DR 3/16" 6 PT Deep |
| J4707L | Socket, 1/4" DR 7/32" 6 PT Deep |
| J4708L | Socket, 1/4" DR 1/4" 6 PT Deep |
| J4709L | Socket, 1/4" DR 9/32" 6 PT Deep |
| J4711L | Socket, 1/4" DR 11/32" 6 PT Deep |
| J4710L | Socket, 1/4" DR 5/16" 6 PT Deep |
| J4712L | Socket, 1/4" DR 3/8" 6 PT Deep |
| J4714L | Socket, 1/4" DR 7/16" 6 PT Deep |
| J4716L | Socket, 1/4" DR 1/2" 6 PT Deep |
| J4718L | Socket, 1/4" DR 9/16" 6 PT Deep |
| J4704LM | Socket, 1/4" DR 4 mm 6 PT Deep |
| J4705LM | Socket, 1/4" DR 5 mm 6 PT Deep |
| J47055LM | Socket, 1/4" DR 5.5 mm 6 PT Deep |
| J4706LM | Socket, 1/4" DR 6 mm 6 PT Deep |
| J4707LM | Socket, 1/4" DR 7 mm 6 PT Deep |
| J4708LM | Socket, 1/4" DR 8 mm 6 PT Deep |
| J4709LM | Socket, 1/4" DR 9 mm 6 PT Deep |
| J4710LM | Socket, 1/4" DR 10 mm 6 PT Deep |
| J4711LM | Socket, 1/4" DR 11 mm 6 PT Deep |
| J4712LM | Socket, 1/4" DR 12 mm 6 PT Deep |
| J4713LM | Socket, 1/4" DR 13 mm 6 PT Deep |
| J4714LM | Socket, 1/4" DR 14 mm 6 PT Deep |
| J4708S | Socket, 1/4" DR 1/4" 8 PT |

| Contents | Description |
|-----------------|-----------------------------------|
| J4710S | Socket, 1/4" DR 5/16" 8 PT |
| J4712S | Socket, 1/4" DR 3/8" 8 PT |
| J4705LTM | Socket, 1/4" DR 5 mm 12 PT Deep |
| J47055LTM | Socket, 1/4" DR 5.5 mm 12 PT Deep |
| J4706LTM | Socket, 1/4" DR 6 mm 12 PT Deep |
| J4707LTM | Socket, 1/4" DR 7 mm 12 PT Deep |
| J4708LTM | Socket, 1/4" DR 8 mm 12 PT Deep |
| J4709LTM | Socket, 1/4" DR 9 mm 12 PT Deep |
| J4710LTM | Socket, 1/4" DR 10 mm 12 PT Deep |
| J4711LTM | Socket, 1/4" DR 11 mm 12 PT Deep |
| J4712LTM | Socket, 1/4" DR 12 mm 12 PT Deep |
| J4713LTM | Socket, 1/4" DR 13 mm 12 PT Deep |
| J4714LTM | Socket, 1/4" DR 14 mm 12 PT Deep |
| J5208S | Socket, 3/8" DR 1/4" 8 PT |
| J5210S | Socket, 3/8" DR 5/16" 8 PT |
| J5212S | Socket, 3/8" DR 3/8" 8 PT |
| J5214S | Socket, 3/8" DR 7/16" 8 PT |
| J5216S | Socket, 3/8" DR 1/2" 8 PT |
| J5208 | Socket, 3/8" DR 1/4" 12 PT |
| J5210 | Socket, 3/8" DR 5/16" 12 PT |
| J5212 | Socket, 3/8" DR 3/8" 12 PT |
| J5214 | Socket, 3/8" DR 7/16" 12 PT |
| J5216 | Socket, 3/8" DR 1/2" 12 PT |
| J5218 | Socket, 3/8" DR 9/16" 12 PT |
| J5220 | Socket, 3/8" DR 5/8" 12 PT |
| J5222 | Socket, 3/8" DR 11/16" 12 PT |
| J5224 | Socket, 3/8" DR 3/4" 12 PT |
| J5226 | Socket, 3/8" DR 13/16" 12 PT |
| J5228 | Socket, 3/8" DR 7/8" 12 PT |
| J5230 | Socket, 3/8" DR 15/16" 12 PT |
| J5232 | Socket, 3/8" DR 1" 12 PT |
| J5208M | Socket, 3/8" DR 8 mm 12 PT |
| J5209M | Socket, 3/8" DR 9 mm 12 PT |
| J5210M | Socket, 3/8" DR 10 mm 12 PT |
| J5211M | Socket, 3/8" DR 11 mm 12 PT |
| J5212M | Socket, 3/8" DR 12 mm 12 PT |
| J5213M | Socket, 3/8" DR 13 mm 12 PT |
| J5214M | Socket, 3/8" DR 14 mm 12 PT |
| J5215M | Socket, 3/8" DR 15 mm 12 PT |
| J5216M | Socket, 3/8" DR 16 mm 12 PT |
| J5217M | Socket, 3/8" DR 17 mm 12 PT |
| J5218M | Socket, 3/8" DR 18 mm 12 PT |
| J5219M | Socket, 3/8" DR 19 mm 12 PT |
| J5008 | Socket, 3/8" DR 1/4" 12 PT Deep |
| J5010 | Socket, 3/8" DR 5/16" 12 PT Deep |
| J5012 | Socket, 3/8" DR 3/8" 12 PT Deep |
| J5014 | Socket, 3/8" DR 7/16" 12 PT Deep |
| J5016 | Socket, 3/8" DR 1/2" 12 PT Deep |
| J5018 | Socket, 3/8" DR 9/16" 12 PT Deep |
| J5020 | Socket, 3/8" DR 5/8" 12 PT Deep |
| J5022 | Socket, 3/8" DR 11/16" 12 PT Deep |
| J5024 | Socket, 3/8" DR 3/4" 12 PT Deep |
| J5026 | Socket, 3/8" DR 13/16" 12 PT Deep |
| J5028 | Socket, 3/8" DR 7/8" 12 PT Deep |
| J5030 | Socket, 3/8" DR 15/16" 12 PT Deep |
| J5032 | Socket, 3/8" DR 1" 12 PT Deep |
| J5008M | Socket, 3/8" DR 8 mm 12 PT Deep |
| J5009M | Socket, 3/8" DR 9 mm 12 PT Deep |

(CONTINUED ON NEXT PAGE)

1046 PC MASTER TECHNICIAN MAINTENANCE SET (CONTINUED)

Product #: JCS-1046MAS



| Contents | Description | Contents | Description |
|----------|----------------------------------|----------|--|
| J5010M | Socket, 3/8" DR 10 mm 12 PT Deep | J5424M | Socket, 1/2" DR 24 mm 12 PT |
| J5011M | Socket, 3/8" DR 11 mm 12 PT Deep | J5316 | Socket, 1/2" DR 1/2" 12 PT Deep |
| J5012M | Socket, 3/8" DR 12 mm 12 PT Deep | J5318 | Socket, 1/2" DR 9/16" 12 PT Deep |
| J5013M | Socket, 3/8" DR 13 mm 12 PT Deep | J5320 | Socket, 1/2" DR 5/8" 12 PT Deep |
| J5014M | Socket, 3/8" DR 14 mm 12 PT Deep | J5322 | Socket, 1/2" DR 11/16" 12 PT Deep |
| J5015M | Socket, 3/8" DR 15 mm 12 PT Deep | J5324 | Socket, 1/2" DR 3/4" 12 PT Deep |
| J5016M | Socket, 3/8" DR 16 mm 12 PT Deep | J5326 | Socket, 1/2" DR 13/16" 12 PT Deep |
| J5017M | Socket, 3/8" DR 17 mm 12 PT Deep | J5328 | Socket, 1/2" DR 7/8" 12 PT Deep |
| J5018M | Socket, 3/8" DR 18 mm 12 PT Deep | J5330 | Socket, 1/2" DR 15/16" 12 PT Deep |
| J5019M | Socket, 3/8" DR 19 mm 12 PT Deep | J5332 | Socket, 1/2" DR 1" 12 PT Deep |
| J5414S | Socket, 1/2" DR 7/16" 8 PT | J5334 | Socket, 1/2" DR 1-1/16" 12 PT Deep |
| J5412S | Socket, 1/2" DR 3/8" 8 PT | J5336 | Socket, 1/2" DR 1-1/8" 12 PT Deep |
| J5418S | Socket, 1/2" DR 9/16" 8 PT | J5340 | Socket, 1/2" DR 1-1/4" 12 PT Deep |
| J5416S | Socket, 1/2" DR 1/2" 8 PT | J5310M | Socket, 1/2" DR 10 mm 12 PT Deep |
| J5420S | Socket, 1/2" DR 5/8" 8 PT | J5311M | Socket, 1/2" DR 11 mm 12 PT Deep |
| J5422S | Socket, 1/2" DR 11/16" 8 PT | J5312M | Socket, 1/2" DR 12 mm 12 PT Deep |
| J5424S | Socket, 1/2" DR 3/4" 8 PT | J5313M | Socket, 1/2" DR 13 mm 12 PT Deep |
| J5426S | Socket, 1/2" DR 13/16" 8 PT | J5314M | Socket, 1/2" DR 14 mm 12 PT Deep |
| J5428S | Socket, 1/2" DR 7/8" 8 PT | J5315M | Socket, 1/2" DR 15 mm 12 PT Deep |
| J5432S | Socket, 1/2" DR 1" 8 PT | J5316M | Socket, 1/2" DR 16 mm 12 PT Deep |
| J5412 | Socket, 1/2" DR 3/8" 12 PT | J5317M | Socket, 1/2" DR 17 mm 12 PT Deep |
| J5414 | Socket, 1/2" DR 7/16" 12 PT | J5318M | Socket, 1/2" DR 18 mm 12 PT Deep |
| J5416 | Socket, 1/2" DR 1/2" 12 PT | J5319M | Socket, 1/2" DR 19 mm 12 PT Deep |
| J5418 | Socket, 1/2" DR 9/16" 12 PT | J5320M | Socket, 1/2" DR 20 mm 12 PT Deep |
| J5419 | Socket, 1/2" DR 19/32" 12 PT | J5321M | Socket, 1/2" DR 21 mm 12 PT Deep |
| J5420 | Socket, 1/2" DR 5/8" 12 PT | J5322M | Socket, 1/2" DR 22 mm 12 PT Deep |
| J5422 | Socket, 1/2" DR 11/16" 12 PT | J5323M | Socket, 1/2" DR 23 mm 12 PT Deep |
| J5424 | Socket, 1/2" DR 3/4" 12 PT | J5324M | Socket, 1/2" DR 24 mm 12 PT Deep |
| J5425 | Socket, 1/2" DR 25/32" 12 PT | J69X12 | Socket, Extractor 3/8" |
| J5426 | Socket, 1/2" DR 13/16" 12 PT | J7411M | Socket, Impact 1/2" DR 11 mm 6 PT |
| J5428 | Socket, 1/2" DR 7/8" 12 PT | J7412M | Socket, Impact 1/2" DR 12 mm 6 PT |
| J5429 | Socket, 1/2" DR 29/32" 12 PT | J7413M | Socket, Impact 1/2" DR 13 mm 6 PT |
| J5430 | Socket, 1/2" DR 15/16" 12 PT | J7414M | Socket, Impact 1/2" DR 14 mm 6 PT |
| J5432 | Socket, 1/2" DR 1" 12 PT | J7415M | Socket, Impact 1/2" DR 15 mm 6 PT |
| J5434 | Socket, 1/2" DR 1-1/16" 12 PT | J7416M | Socket, Impact 1/2" DR 16 mm 6 PT |
| J5436 | Socket, 1/2" DR 1-1/8" 12 PT | J7417M | Socket, Impact 1/2" DR 17 mm 6 PT |
| J5438 | Socket, 1/2" DR 1-3/16" 12 PT | J7418M | Socket, Impact 1/2" DR 18 mm 6 PT |
| J5440 | Socket, 1/2" DR 1-1/4" 12 PT | J7419M | Socket, Impact 1/2" DR 19 mm 6 PT |
| J5442 | Socket, 1/2" DR 1-5/16" 12 PT | J7420M | Socket, Impact 1/2" DR 20 mm 6 PT |
| J5444 | Socket, 1/2" DR 1-3/8" 12 PT | J7421M | Socket, Impact 1/2" DR 21 mm 6 PT |
| J5446 | Socket, 1/2" DR 1-7/16" 12 PT | J7422M | Socket, Impact 1/2" DR 22 mm 6 PT |
| J5448 | Socket, 1/2" DR 1-1/2" 12 PT | J7423M | Socket, Impact 1/2" DR 23 mm 6 PT |
| J5410M | Socket, 1/2" DR 10 mm 12 PT | J7424M | Socket, Impact 1/2" DR 24 mm 6 PT |
| J5411M | Socket, 1/2" DR 11 mm 12 PT | J7312H | Socket, Impact 1/2" DR 3/8" 6 PT Deep |
| J5412M | Socket, 1/2" DR 12 mm 12 PT | J7314H | Socket, Impact 1/2" DR 7/16" 6 PT Deep |
| J5413M | Socket, 1/2" DR 13 mm 12 PT | J7316H | Socket, Impact 1/2" DR 1/2" 6 PT Deep |
| J5414M | Socket, 1/2" DR 14 mm 12 PT | J7318H | Socket, Impact 1/2" DR 9/16" 6 PT Deep |
| J5415M | Socket, 1/2" DR 15 mm 12 PT | J7320H | Socket, Impact 1/2" DR 5/8" 6 PT Deep |
| J5416M | Socket, 1/2" DR 16 mm 12 PT | J7322H | Socket, Impact 1/2" DR 11/16" 6 PT Deep |
| J5417M | Socket, 1/2" DR 17 mm 12 PT | J7324H | Socket, Impact 1/2" DR 3/4" 6 PT Deep |
| J5418M | Socket, 1/2" DR 18 mm 12 PT | J7326H | Socket, Impact 1/2" DR 13/16" 6 PT Deep |
| J5419M | Socket, 1/2" DR 19 mm 12 PT | J7328H | Socket, Impact 1/2" DR 7/8" 6 PT Deep |
| J5420M | Socket, 1/2" DR 20 mm 12 PT | J7330H | Socket, Impact 1/2" DR 15/16" 6 PT Deep |
| J5421M | Socket, 1/2" DR 21 mm 12 PT | J7332H | Socket, Impact 1/2" DR 1" 6 PT Deep |
| J5422M | Socket, 1/2" DR 22 mm 12 PT | J7334H | Socket, Impact 1/2" DR 1-1/16" 6 PT Deep |
| J5423M | Socket, 1/2" DR 23 mm 12 PT | J5477A | Socket, Universal 1/2" DR 5/8" 12 PT |





| Contents | Description |
|------------|---|
| J5476A | Socket, Universal 1/2" DR 9/16" 12 PT |
| J5444A | Socket, 1/2" DR Drag Link 3/4" |
| J5446A | Socket, 1/2" DR Drag Link 15/16" |
| J5528 | Socket, 3/4" DR 7/8" 12 PT |
| J5530 | Socket, 3/4" DR 15/16" 12 PT |
| J5532 | Socket, 3/4" DR 1" 12 PT |
| J5534 | Socket, 3/4" DR 1-1/16" 12 PT |
| J5536 | Socket, 3/4" DR 1-1/8" 12 PT |
| J5538 | Socket, 3/4" DR 1-3/16" 12 PT |
| J5540 | Socket, 3/4" DR 1-1/4" 12 PT |
| J5542 | Socket, 3/4" DR 1-5/16" 12 PT |
| J5544 | Socket, 3/4" DR 1-3/8" 12 PT |
| J5546 | Socket, 3/4" DR 1-7/16" 12 PT |
| J5548 | Socket, 3/4" DR 1-1/2" 12 PT |
| J5550 | Socket, 3/4" DR 1-9/16" 12 PT |
| J5552 | Socket, 3/4" DR 1-5/8" 12 PT |
| J5554 | Socket, 3/4" DR 1-11/16" 12 PT |
| J5556 | Socket, 3/4" DR 1-3/4" 12 PT |
| J5558 | Socket, 3/4" DR 1-13/16" 12 PT |
| J5560 | Socket, 3/4" DR 1-7/8" 12 PT |
| J5564 | Socket, 3/4" DR 2" 12 PT |
| J5568 | Socket, 3/4" DR 2-1/8" 12 PT |
| J5570 | Socket, 3/4" DR 2-3/16" 12 PT |
| J5572 | Socket, 3/4" DR 2-1/4" 12 PT |
| J5576 | Socket, 3/4" DR 2-3/8" 12 PT |
| J4737 | Socket, Bit 1/4" DR #1 Phillips® |
| J4738 | Socket, Bit 1/4" DR #2 Phillips® |
| J5241 | Socket, Bit 3/8" DR #2 Phillips® |
| J5242 | Socket, Bit 3/8" DR #3 Phillips® |
| J5243 | Socket, Bit 3/8" DR #4 Phillips® |
| J4743 | Socket, Bit 1/4" DR Slotted 1/4" 1-3/16" |
| J4744 | Socket, Bit 1/4" DR Slotted 3/16" |
| J4745 | Socket, Bit 1/4" DR Slotted 1/4" 1-13/64" |
| J5246 | Socket, Bit 3/8" DR Slotted |
| J69X09 | Socket, Extractor 1/4" DR 7 mm |
| J69X10 | Socket, Extractor 1/4" DR 8 mm |
| J69X11 | Socket, Extractor 1/4" DR 9 mm |
| J69X13 | Socket, Extractor 1/4" DR 10 mm |
| J69X14 | Socket, Extractor 1/4" DR 11 mm |
| J69X15 | Socket, Extractor 1/4" DR 12 mm |
| J69X16 | Socket, Extractor 1/4" DR 13 mm |
| J69X18 | Socket, Extractor 1/4" DR 14 mm |
| J69X20 | Socket, Extractor 1/4" DR 15 mm |
| J47701/16 | Socket, Hex Bit 1/4" DR 1/16" |
| J47705/64 | Socket, Hex Bit 1/4" DR 5/64" |
| J47703/32 | Socket, Hex Bit 1/4" DR 3/32" |
| J47707/64 | Socket, Hex Bit 1/4" DR 7/64" |
| J47701/8 | Socket, Hex Bit 1/4" DR 1/8" |
| J47709/64 | Socket, Hex Bit 1/4" DR 9/64" |
| J47705/32 | Socket, Hex Bit 1/4" DR 5/32" |
| J47703/16 | Socket, Hex Bit 1/4" DR 3/16" |
| J47707/32 | Socket, Hex Bit 1/4" DR 7/32" |
| J47701/4 | Socket, Hex Bit 1/4" DR 1/4" |
| J47705/16 | Socket, Hex Bit 1/4" DR 5/16" |
| J4770-2M | Socket, Hex Bit 1/4" DR 2 mm |
| J4770-2.5M | Socket, Hex Bit 1/4" DR 2.5 mm |
| J4770-3M | Socket, Hex Bit 1/4" DR 3 mm |
| J4770-4M | Socket, Hex Bit 1/4" DR 4 mm |

| Contents | Description |
|-----------|---|
| J4770-5M | Socket, Hex Bit 1/4" DR 5 mm |
| J4770-6M | Socket, Hex Bit 1/4" DR 6 mm |
| J49901/8 | Socket, Hex Bit 3/8" DR 1/8" |
| J49905/32 | Socket, Hex Bit 3/8" DR 5/32" |
| J49903/16 | Socket, Hex Bit 3/8" DR 3/16" |
| J49907/32 | Socket, Hex Bit 3/8" DR 7/32" |
| J49901/4 | Socket, Hex Bit 3/8" DR 1/4" |
| J49905/16 | Socket, Hex Bit 3/8" DR 5/16" |
| J49903/8 | Socket, Hex Bit 3/8" DR 3/8" |
| J4990-4M | Socket, Hex Bit 3/8" DR 4 mm |
| J4990-5M | Socket, Hex Bit 3/8" DR 5 mm |
| J4990-6M | Socket, Hex Bit 3/8" DR 6 mm |
| J4990-7M | Socket, Hex Bit 3/8" DR 7 mm |
| J4990-8M | Socket, Hex Bit 3/8" DR 8 mm |
| J4990-9M | Socket, Hex Bit 3/8" DR 9 mm |
| J4990-10M | Socket, Hex Bit 3/8" DR 10 mm |
| J54411/4 | Socket, Hex Bit 1/2" DR 1/4" |
| J54415/16 | Socket, Hex Bit 1/2" DR 5/16" |
| J54413/8 | Socket, Hex Bit 1/2" DR 3/8" |
| J54417/16 | Socket, Hex Bit 1/2" DR 7/16" |
| J54411/2 | Socket, Hex Bit 1/2" DR 1/2" |
| J54419/16 | Socket, Hex Bit 1/2" DR 9/16" |
| J54415/8 | Socket, Hex Bit 1/2" DR 5/8" |
| J5441-12M | Socket, Hex Bit 1/2" DR 12 mm |
| J5441-14M | Socket, Hex Bit 1/2" DR 14 mm |
| J5441-17M | Socket, Hex Bit 1/2" DR 17 mm |
| J7208H | Socket, Impact 3/8" DR 1/4" 6 PT |
| J7209H | Socket, Impact 3/8" DR 9/32" 6 PT |
| J7210H | Socket, Impact 3/8" DR 5/16" 6 PT |
| J7211H | Socket, Impact 3/8" DR 11/32" 6 PT |
| J7212H | Socket, Impact 3/8" DR 3/8" 6 PT |
| J7214H | Socket, Impact 3/8" DR 7/16" 6 PT |
| J7216H | Socket, Impact 3/8" DR 1/2" 6 PT |
| J7218H | Socket, Impact 3/8" DR 9/16" 6 PT |
| J7220H | Socket, Impact 3/8" DR 5/8" 6 PT |
| J7222H | Socket, Impact 3/8" DR 11/16" 6 PT |
| J7224H | Socket, Impact 3/8" DR 3/4" 6 PT |
| J7226H | Socket, Impact 3/8" DR 13/16" 6 PT |
| J7228H | Socket, Impact 3/8" DR 7/8" 6 PT |
| J7230H | Socket, Impact 3/8" DR 15/16" 6 PT |
| J7232H | Socket, Impact 3/8" DR 1" 6 PT |
| J7412H | Socket, Impact 1/2" DR 3/8" 6 PT |
| J7414H | Socket, Impact 1/2" DR 7/16" 6 PT |
| J7416H | Socket, Impact 1/2" DR 1/2" 6 PT |
| J7418H | Socket, Impact 1/2" DR 9/16" 6 PT |
| J7420H | Socket, Impact 1/2" DR 5/8" 6 PT |
| J7422H | Socket, Impact 1/2" DR 11/16" 6 PT |
| J7424H | Socket, Impact 1/2" DR 3/4" 6 PT |
| J7426H | Socket, Impact 1/2" DR 13/16" 6 PT |
| J7428H | Socket, Impact 1/2" DR 7/8" 6 PT |
| J7430H | Socket, Impact 1/2" DR 15/16" 6 PT |
| J7432H | Socket, Impact 1/2" DR 1" 6 PT |
| J7434H | Socket, Impact 1/2" DR 1-1/16" 6 PT |
| J7436H | Socket, Impact 1/2" DR 1-1/8" 6 PT |
| J7438H | Socket, Impact 1/2" DR 1-3/16" 6 PT |
| J7440H | Socket, Impact 1/2" DR 1-1/4" 6 PT |
| J7410M | Socket, Impact 1/2" DR 10 mm 6 PT |
| J7336H | Socket, Impact 1/2" DR 1-1/8" 6 PT Deep |

(CONTINUED ON NEXT PAGE)

1046 PC MASTER TECHNICIAN MAINTENANCE SET (CONTINUED)

Product #: JCS-1046MAS



| Contents | Description | Contents | Description |
|-----------|--|----------|---|
| J7338H | Socket, Impact 1/2" DR 1-3/16" 6 PT Deep | J5275HAM | Socket, Universal 3/8 DR 12 mm 6 PT |
| J7340H | Socket, Impact 1/2" DR 1-1/4" 6 PT Deep | J5276HAM | Socket, Universal 3/8 DR 13 mm 6 PT |
| J7342H | Socket, Impact 1/2" DR 1-5/16" 6 PT Deep | J5277HAM | Socket, Universal 3/8 DR 14 mm 6 PT |
| J7344H | Socket, Impact 1/2" DR 1-3/8" 6 PT Deep | J5278HAM | Socket, Universal 3/8 DR 15 mm 6 PT |
| J7346H | Socket, Impact 1/2" DR 1-7/16" 6 PT Deep | J5279HAM | Socket, Universal 3/8 DR 16 mm 6 PT |
| J7348H | Socket, Impact 1/2" DR 1-1/2" 6 PT Deep | J5280HAM | Socket, Universal 3/8 DR 17 mm 6 PT |
| J7310M | Socket, Impact 1/2" DR 10 mm 6 PT Deep | J5281HAM | Socket, Universal 3/8 DR 18 mm 6 PT |
| J7311M | Socket, Impact 1/2" DR 11 mm 6 PT Deep | J5282HAM | Socket, Universal 3/8 DR 19 mm 6 PT |
| J7312M | Socket, Impact 1/2" DR 12 mm 6 PT Deep | J5273A | Socket, Universal 3/8" DR 3/8" 12 PT |
| J7313M | Socket, Impact 1/2" DR 13 mm 6 PT Deep | J5274A | Socket, Universal 3/8" DR 7/16" 12 PT |
| J7314M | Socket, Impact 1/2" DR 14 mm 6 PT Deep | J5275A | Socket, Universal 3/8" DR 1/2" 12 PT |
| J7315M | Socket, Impact 1/2" DR 15 mm 6 PT Deep | J5276A | Socket, Universal 3/8" DR 9/16" 12 PT |
| J7316M | Socket, Impact 1/2" DR 16 mm 6 PT Deep | J5277A | Socket, Universal 3/8" DR 5/8" 12 PT |
| J7317M | Socket, Impact 1/2" DR 17 mm 6 PT Deep | J5278A | Socket, Universal 3/8" DR 11/16" 12 PT |
| J7318M | Socket, Impact 1/2" DR 18 mm 6 PT Deep | J5279A | Socket, Universal 3/8" DR 3/4" 12 PT |
| J7319M | Socket, Impact 1/2" DR 19 mm 6 PT Deep | J5475A | Socket, Universal 1/2" DR 1/2" 12 PT |
| J7320M | Socket, Impact 1/2" DR 20 mm 6 PT Deep | 68-768 | Tap and Die, 76 PC Set |
| J7321M | Socket, Impact 1/2" DR 21 mm 6 PT Deep | 33-212 | Tape Rule, Stanley® Powerlock® with Metal Case 1/2" x 12' |
| J7322M | Socket, Impact 1/2" DR 22 mm 6 PT Deep | J350 | Tubing Cutter |
| J7323M | Socket, Impact 1/2" DR 23 mm 6 PT Deep | J351 | Tubing Flaring Tool |
| J7324M | Socket, Impact 1/2" DR 24 mm 6 PT Deep | 55-515 | Wonder Bar® 13-3/8" |
| J07512 | Socket, Impact 3/4" DR 3/4" 6 PT | J706 | Wrench, Adjustable 6" |
| J07513 | Socket, Impact 3/4" DR 13/16" 6 PT | J708 | Wrench, Adjustable 8" |
| J07514 | Socket, Impact 3/4" DR 7/8" 6 PT | J710 | Wrench, Adjustable 10" |
| J07515 | Socket, Impact 3/4" DR 15/16" 6 PT | J712 | Wrench, Adjustable 12" |
| J07516 | Socket, Impact 3/4" DR 1" 6 PT | J715 | Wrench, Adjustable 15" |
| J07517 | Socket, Impact 3/4" DR 1-1/16" 6 PT | J3314 | Wrench, Angle 7/32" |
| J07518 | Socket, Impact 3/4" DR 1-1/8" 6 PT | J3315 | Wrench, Angle 15/64" |
| J07519 | Socket, Impact 3/4" DR 1-3/16" 6 PT | J3316 | Wrench, Angle 1/4" |
| J07520 | Socket, Impact 3/4" DR 1-1/4" 6 PT | J3318 | Wrench, Angle 9/32" |
| J07521 | Socket, Impact 3/4" DR 1-5/16" 6 PT | J3320 | Wrench, Angle 5/16" |
| J74411/4 | Socket, Impact Hex Bit 1/2" DR 1/4" | J3322 | Wrench, Angle 11/32" |
| J74415/16 | Socket, Impact Hex Bit 1/2" DR 5/16" | J3324 | Wrench, Angle 3/8" |
| J74413/8 | Socket, Impact Hex Bit 1/2" DR 3/8" | J3112 | Wrench, Angle 3/8" |
| J74417/16 | Socket, Impact Hex Bit 1/2" DR 7/16" | J3328 | Wrench, Angle 7/16" |
| J74411/2 | Socket, Impact Hex Bit 1/2" DR 1/2" | J3114 | Wrench, Angle 7/16" |
| J74419/16 | Socket, Impact Hex Bit 1/2" DR 9/16" | J3332 | Wrench, Angle 1/2" |
| J74415/8 | Socket, Impact Hex Bit 1/2" DR 5/8" | J3116 | Wrench, Angle 1/2" |
| J4770TA | Socket, Universal 1/4 DR 7/32" 12 PT | J3118 | Wrench, Angle 9/16" |
| J4771TA | Socket, Universal 1/4 DR 1/4" 12 PT | J3120 | Wrench, Angle 5/8" |
| J4777TA | Socket, Universal 1/4 DR 9/32" 12 PT | J3122 | Wrench, Angle 11/16" |
| J4772TA | Socket, Universal 1/4 DR 5/16" 12 PT | J3124 | Wrench, Angle 3/4" |
| J4778TA | Socket, Universal 1/4 DR 11/32" 12 PT | J3126 | Wrench, Angle 13/16" |
| J4773TA | Socket, Universal 1/4 DR 3/8" 12 PT | J3128 | Wrench, Angle 7/8" |
| J4774TA | Socket, Universal 1/4 DR 7/16" 12 PT | J3130 | Wrench, Angle 15/16" |
| J4775TA | Socket, Universal 1/4 DR 1/2" 12 PT | J3132 | Wrench, Angle 1" |
| J4776TA | Socket, Universal 1/4 DR 9/16" 12 PT | J3134 | Wrench, Angle 1-1/16" |
| J5273HA | Socket, Universal 3/8" DR 3/8" 6 PT | J3136 | Wrench, Angle 1-1/8" |
| J5274HA | Socket, Universal 3/8" DR 7/16" 6 PT | J3140 | Wrench, Angle 1-1/4" |
| J5275HA | Socket, Universal 3/8" DR 1/2" 6 PT | J3210 | Wrench, Angle 13/64" x 15/64" Short |
| J5276HA | Socket, Universal 3/8" DR 9/16" 6 PT | J3215 | Wrench, Angle 7/32" x 1/4" Short |
| J5277HA | Socket, Universal 3/8" DR 5/8" 6 PT | J3211 | Wrench, Angle 15/64" x 13/64" Short |
| J5278HA | Socket, Universal 3/8" DR 11/16" 6 PT | J3216 | Wrench, Angle 1/4" x 7/32" Short |
| J5279HA | Socket, Universal 3/8" DR 3/4" 6 PT | J3220 | Wrench, Angle 9/32" x 5/16" Short |
| J5273HAM | Socket, Universal 3/8 DR 10 mm 6 PT | J3221 | Wrench, Angle 5/16" x 9/32" Short |
| J5274HAM | Socket, Universal 3/8 DR 11 mm 6 PT | | |





| Contents | Description |
|----------|--------------------------------------|
| J3225 | Wrench, Angle 11/32" x 3/8" Short |
| J3226 | Wrench, Angle 3/8" x 11/32" Short |
| J3109M | Wrench, Angle 9 mm |
| J3110M | Wrench, Angle 10 mm |
| J3111M | Wrench, Angle 11 mm |
| J3112M | Wrench, Angle 12 mm |
| J3113M | Wrench, Angle 13 mm |
| J3114M | Wrench, Angle 14 mm |
| J3115M | Wrench, Angle 15 mm |
| J3116M | Wrench, Angle 16 mm |
| J3117M | Wrench, Angle 17 mm |
| J3118M | Wrench, Angle 18 mm |
| J3119M | Wrench, Angle 19 mm |
| J1170 | Wrench, Box 5/16" x 3/8" 12 PT |
| J1171 | Wrench, Box 7/16" x 1/2" 12 PT |
| J1172 | Wrench, Box 9/16" x 5/8" 12 PT |
| J1173 | Wrench, Box 11/16" x 3/4" 12 PT |
| J1174 | Wrench, Box 13/16" x 7/8" 12 PT |
| J1175 | Wrench, Box 15/16" x 1" 12 PT |
| J1176 | Wrench, Box 1-1/16" x 1-1/8" 12 PT |
| J1050M | Wrench, Box 6 x 7 mm 12 PT |
| J1051M | Wrench, Box 8 x 9 mm 12 PT |
| J1053M | Wrench, Box 10 x 11 mm 12 PT |
| J1057M | Wrench, Box 12 x 13 mm 12 PT |
| J1061M | Wrench, Box 14 x 15 mm 12 PT |
| J1064M | Wrench, Box 16 x 18 mm 12 PT |
| J1065M | Wrench, Box 17 x 19 mm 12 PT |
| J1072M | Wrench, Box 21 x 24 mm 12 PT |
| J1073M | Wrench, Box 22 x 24 mm 12 PT |
| J1077M | Wrench, Box 27 x 30 mm 12 PT |
| J1079M | Wrench, Box 30 x 32 mm 12 PT |
| J1120 | Wrench, Box 5/16" x 3/8" 12 PT Short |
| J1122 | Wrench, Box 3/8" x 7/16" 12 PT Short |
| J1126 | Wrench, Box 1/2" x 9/16" 12 PT Short |
| J1131 | Wrench, Box 5/8" x 3/4" 12 PT Short |
| J801 | Wrench, Chain |
| J1210A | Wrench, Combination 5/16" 12 PT |
| J1212ASD | Wrench, Combination 3/8" 12 PT |
| J1214ASD | Wrench, Combination 7/16" 12 PT |
| J1216ASD | Wrench, Combination 1/2" 12 PT |
| J1218ASD | Wrench, Combination 9/16" 12 PT |
| J1220ASD | Wrench, Combination 5/8" 12 PT |
| J1222ASD | Wrench, Combination 11/16" 12 PT |
| J1224ASD | Wrench, Combination 3/4" 12 PT |
| J1226ASD | Wrench, Combination 13/16" 12 PT |
| J1228ASD | Wrench, Combination 7/8" 12 PT |
| J1230ASD | Wrench, Combination 15/16" 12 PT |
| J1232ASD | Wrench, Combination 1" 12 PT |
| J1234ASD | Wrench, Combination 1-1/16" 12 PT |
| J1236ASD | Wrench, Combination 1-1/8" 12 PT |
| J1240ASD | Wrench, Combination 1-1/4" 12 PT |
| J1242 | Wrench, Combination 1-5/16" 12 PT |
| J1244 | Wrench, Combination 1-3/8" 12 PT |
| J1246 | Wrench, Combination 1-7/16" 12 PT |
| J1248 | Wrench, Combination 1-1/2" 12 PT |
| J1207MA | Wrench, Combination 7 mm 12 PT |
| J1208MA | Wrench, Combination 8 mm 12 PT |
| J1209MA | Wrench, Combination 9 mm 12 PT |

| Contents | Description |
|-----------|--|
| J1210MASD | Wrench, Combination 10 mm 12 PT |
| J1211MASD | Wrench, Combination 11 mm 12 PT |
| J1212MASD | Wrench, Combination 12 mm 12 PT |
| J1213MASD | Wrench, Combination 13 mm 12 PT |
| J1214MASD | Wrench, Combination 14 mm 12 PT |
| J1215MASD | Wrench, Combination 15 mm 12 PT |
| J1216MASD | Wrench, Combination 16 mm 12 PT |
| J1217MASD | Wrench, Combination 17 mm 12 PT |
| J1218MASD | Wrench, Combination 18 mm 12 PT |
| J1219MASD | Wrench, Combination 19 mm 12 PT |
| J1220MASD | Wrench, Combination 20 mm 12 PT |
| J1221MASD | Wrench, Combination 21 mm 12 PT |
| J1222MASD | Wrench, Combination 22 mm 12 PT |
| J1223MASD | Wrench, Combination 23 mm 12 PT |
| J1224MASD | Wrench, Combination 24 mm 12 PT |
| J1204EF | Wrench, Combination 1/8" 6 PT Short |
| J1205EF | Wrench, Combination 5/32" 6 PT Short |
| J1206EF | Wrench, Combination 3/16" 6 PT Short |
| J1208EF | Wrench, Combination 1/4" 6 PT Short |
| J1209EF | Wrench, Combination 9/32" 6 PT Short |
| J1210EF | Wrench, Combination 5/16" 6 PT Short |
| J1211EF | Wrench, Combination 11/32" 6 PT Short |
| J1212EF | Wrench, Combination 3/8" 6 PT Short |
| J4708CF | Wrench, Crowfoot 1/4" DR 1/4" Open End |
| J4710CF | Wrench, Crowfoot 1/4" DR 5/16" Open End |
| J4712CF | Wrench, Crowfoot 1/4" DR 3/8" Open End |
| J4714CF | Wrench, Crowfoot 1/4" DR 7/16" Open End |
| J4716CF | Wrench, Crowfoot 1/4" DR 1/2" Open End |
| J4718CF | Wrench, Crowfoot 1/4" DR 9/16" Open End |
| J4912CF | Wrench, Crowfoot 3/8" DR 3/8" Open End |
| J4914CF | Wrench, Crowfoot 3/8" DR 7/16" Open End |
| J4916CF | Wrench, Crowfoot 3/8" DR 1/2" Open End |
| J4918CF | Wrench, Crowfoot 3/8" DR 9/16" Open End |
| J4920CF | Wrench, Crowfoot 3/8" DR 5/8" Open End |
| J4922CF | Wrench, Crowfoot 3/8" DR 11/16" Open End |
| J4924CF | Wrench, Crowfoot 3/8" DR 3/4" Open End |
| J4926CF | Wrench, Crowfoot 3/8" DR 13/16" Open End |
| J4928CF | Wrench, Crowfoot 3/8" DR 7/8" Open End |
| J4930CF | Wrench, Crowfoot 3/8" DR 15/16" Open End |
| J4932CF | Wrench, Crowfoot 3/8" DR 1" Open End |
| J4909MCF | Wrench, Crowfoot 3/8" DR 9 mm Open End |
| J4910MCF | Wrench, Crowfoot 3/8" DR 10 mm Open End |
| J4911MCF | Wrench, Crowfoot 3/8" DR 11 mm Open End |
| J4912MCF | Wrench, Crowfoot 3/8" DR 12 mm Open End |
| J4913MCF | Wrench, Crowfoot 3/8" DR 13 mm Open End |
| J4914MCF | Wrench, Crowfoot 3/8" DR 14 mm Open End |
| J4915MCF | Wrench, Crowfoot 3/8" DR 15 mm Open End |
| J4916MCF | Wrench, Crowfoot 3/8" DR 16 mm Open End |
| J4917MCF | Wrench, Crowfoot 3/8" DR 17 mm Open End |
| J4918MCF | Wrench, Crowfoot 3/8" DR 18 mm Open End |
| J4919MCF | Wrench, Crowfoot 3/8" DR 19 mm Open End |
| J4920MCF | Wrench, Crowfoot 3/8" DR 20 mm Open End |
| J4921MCF | Wrench, Crowfoot 3/8" DR 21 mm Open End |
| J4922MCF | Wrench, Crowfoot 3/8" DR 22 mm Open End |
| J4923MCF | Wrench, Crowfoot 3/8" DR 23 mm Open End |
| J4924MCF | Wrench, Crowfoot 3/8" DR 24 mm Open End |
| J5336FL | Wrench, Crowfoot 1/2" DR 1-1/8" |
| J5338FL | Wrench, Crowfoot 1/2" DR 1-3/16" |

(CONTINUED ON NEXT PAGE)



1046 PC MASTER TECHNICIAN MAINTENANCE SET (CONTINUED)

Product #: **JCS-1046MAS**



| Contents | Description | Contents | Description |
|----------|--|-----------|--|
| J5340FL | Wrench, Crowfoot 1/2" DR 1-1/4" | J3824 | Wrench, Flare Nut Ratcheting 3/4" |
| J5342FL | Wrench, Crowfoot 1/2" DR 1-5/16" | J1725 | Wrench, Obstruction 7/16" x 1/2" |
| J5344FL | Wrench, Crowfoot 1/2" DR 1-3/8" | J1730 | Wrench, Obstruction 9/16" x 5/8" |
| J5346FL | Wrench, Crowfoot 1/2" DR 1-7/16" | J1731 | Wrench, Obstruction 5/8" x 3/4" |
| J5348FL | Wrench, Crowfoot 1/2" DR 1-1/2" | J3018 | Wrench, Open End 1/4" x 5/16" |
| J5350FL | Wrench, Crowfoot 1/2" DR 1-9/16" | J3020 | Wrench, Open End 3/8" x 5/16" |
| J5352FL | Wrench, Crowfoot 1/2" DR 1-5/8" | J3025 | Wrench, Open End 7/16" x 1/2" |
| J5354FL | Wrench, Crowfoot 1/2" DR 1-11/16" | J3026 | Wrench, Open End 1/2" x 9/16" |
| J5356FL | Wrench, Crowfoot 1/2" DR 1-3/4" | J3030 | Wrench, Open End 9/16" x 5/8" |
| J5358FL | Wrench, Crowfoot 1/2" DR 1-13/16" | J3031 | Wrench, Open End 5/8" x 3/4" |
| J5360FL | Wrench, Crowfoot 1/2" DR 1-7/8" | J3035 | Wrench, Open End 11/16" x 3/4" |
| J5330CF | Wrench, Crowfoot 1/2" DR 15/16" Open End | J3040 | Wrench, Open End 13/16" x 7/8" |
| J5332CF | Wrench, Crowfoot 1/2" DR 1" Open End | J3045 | Wrench, Open End 15/16" x 1" |
| J5334CF | Wrench, Crowfoot 1/2" DR 1-1/16" Open End | J3050 | Wrench, Open End 1-1/16" x 1-1/8" |
| J5336CF | Wrench, Crowfoot 1/2" DR 1-1/8" Open End | J30607 | Wrench, Open End 6 mm x 7 mm |
| J5338CF | Wrench, Crowfoot 1/2" DR 1-3/16" Open End | J30809 | Wrench, Open End 8 mm x 9 mm |
| J5340CF | Wrench, Crowfoot 1/2" DR 1-1/4" Open End | J31011 | Wrench, Open End 10 mm x 11 mm |
| J5342CF | Wrench, Crowfoot 1/2" DR 1-5/16" Open End | J31213 | Wrench, Open End 12 mm x 13 mm |
| J5344CF | Wrench, Crowfoot 1/2" DR 1-3/8" Open End | J31415 | Wrench, Open End 14 mm x 15 mm |
| J5346CF | Wrench, Crowfoot 1/2" DR 1-7/16" Open End | J31617 | Wrench, Open End 16 mm x 17 mm |
| J5348CF | Wrench, Crowfoot 1/2" DR 1-1/2" Open End | J31819 | Wrench, Open End 18 mm x 19 mm |
| J5350CF | Wrench, Crowfoot 1/2" DR 1-9/16" Open End | J32022 | Wrench, Open End 20 mm x 22 mm |
| J5352CF | Wrench, Crowfoot 1/2" DR 1-5/8" Open End | J32123 | Wrench, Open End 21 mm x 23 mm |
| J5354CF | Wrench, Crowfoot 1/2" DR 1-11/16" Open End | J32426 | Wrench, Open End 24 mm x 26 mm |
| J5356CF | Wrench, Crowfoot 1/2" DR 1-3/4" Open End | J810HD | Wrench, Pipe Heavy-Duty 10" |
| J5358CF | Wrench, Crowfoot 1/2" DR 1-13/16" Open End | J814HD | Wrench, Pipe Heavy-Duty 14" |
| J5360CF | Wrench, Crowfoot 1/2" DR 1-7/8" Open End | J818HD | Wrench, Pipe Heavy-Duty 18" |
| J3707M | Wrench, Flare Nut 7 mm x 8 mm | J1191T-A | Wrench, Ratcheting Box 1/4" x 5/16" 12 PT |
| J3709M | Wrench, Flare Nut 9 mm x 11 mm | J1192T-A | Wrench, Ratcheting Box 3/8" x 7/16" 12 PT |
| J3710M | Wrench, Flare Nut 10 mm x 12 mm | J1193T-A | Wrench, Ratcheting Box 1/2" x 9/16" 12 PT |
| J3713M | Wrench, Flare Nut 13 mm x 14 mm | J1194-A | Wrench, Ratcheting Box 5/8" x 11/16" 12 PT |
| J3715M | Wrench, Flare Nut 15 mm x 17 mm | J1195-A | Wrench, Ratcheting Box 3/4" x 7/8" 12 PT |
| J3751 | Wrench, Flare Nut Combination 3/8" 6 PT | J1191M-A | Wrench, Ratcheting Box 7 mm x 8 mm |
| J3752 | Wrench, Flare Nut Combination 7/16" 6 PT | J1192M-A | Wrench, Ratcheting Box 9 mm x 10 mm |
| J3753 | Wrench, Flare Nut Combination 1/2" 6 PT | J1193MA-A | Wrench, Ratcheting Box 11 mm x 12 mm |
| J3754 | Wrench, Flare Nut Combination 9/16" 6 PT | J1194MA-A | Wrench, Ratcheting Box 13 mm x 14 mm |
| J3755 | Wrench, Flare Nut Combination 5/8" 6 PT | J1195M-A | Wrench, Ratcheting Box 15 mm x 17 mm |
| J3756 | Wrench, Flare Nut Combination 11/16" 6 PT | J1270-12 | Wrench, Swivel Combination 3/8" 12 PT |
| J3757 | Wrench, Flare Nut Combination 3/4" 6 PT | J1270-14 | Wrench, Swivel Combination 7/16" 12 PT |
| J3812 | Wrench, Flare Nut Ratcheting 3/8" | J1270-16 | Wrench, Swivel Combination 1/2" 12 PT |
| J3814 | Wrench, Flare Nut Ratcheting 7/16" | J1270-18 | Wrench, Swivel Combination 9/16" 12 PT |
| J3816 | Wrench, Flare Nut Ratcheting 1/2" | J1270-20 | Wrench, Swivel Combination 5/8" 12 PT |
| J3818 | Wrench, Flare Nut Ratcheting 9/16" | J1270-22 | Wrench, Swivel Combination 11/16" 12 PT |
| J3820 | Wrench, Flare Nut Ratcheting 5/8" | J1270-24 | Wrench, Swivel Combination 3/4" 12 PT |
| J3822 | Wrench, Flare Nut Ratcheting 11/16" | J6014C | Wrench, Torque 1/2" DR 50-250 ft-lbs |



1046 PC MASTER TECHNICIAN MAINTENANCE SET WITH WORKSTATION J455743-13RD

Product #: JCS-1046MASBX1

- › 1046 Pieces.
- › 1/4", 3/8", 1/2", 3/4" Drive Tools.
- › Designed for fastener sizes 1/16" - 2-3/8", 2 mm - 24 mm.
- › Contains: 441 Sockets and Accessories, 237 Wrenches, 41 Striking and Struck Tools, 25 Pliers, 83 Screwdrivers, 219 Miscellaneous Tools.
- › Modules contained: JCS-MAS-1, JCS-MAS-2, JCS-MAS-3, JCS-MAS-4, JCS-MAS-5, JCS-MAS-6, JCS-MOD1046.
- › Enhanced version of Proto® J99951 Master Technician's Maintenance set.
- › Weight: 1137.0 lbs.



Representative Image: Contents May Differ

1046 PC MASTER TECHNICIAN MAINTENANCE SET WITH WORKSTATION J445442-14RD

Product #: JCS-1046MASBX2

- › 1046 Pieces.
- › 1/4", 3/8", 1/2", 3/4" Drive Tools.
- › Designed for fastener sizes 1/16" - 2-3/8", 2 mm - 24 mm.
- › Contains: 441 Sockets and Accessories, 237 Wrenches, 41 Striking and Struck Tools, 25 Pliers, 83 Screwdrivers, 219 Miscellaneous Tools.
- › Modules contained: JCS-MAS-1, JCS-MAS-2, JCS-MAS-3, JCS-MAS-4, JCS-MAS-5, JCS-MAS-6, JCS-MOD1046.
- › Enhanced version of Proto® J99952 Master Technician's Maintenance set.
- › Weight: 847.0 lbs.



Representative Image: Contents May Differ

833 PC MASTER TECHNICIAN MAINTENANCE SET

Product #: **JCS-0833MAS**



- › 833 Pieces.
- › 1/4", 3/8", 1/2", 3/4" Drive Tools.
- › Designed for fastener sizes 1/16" - 2-3/8", 2 mm - 24 mm.
- › Tools only.
- › Contains: 375 Sockets and Accessories, 170 Wrenches, 34 Striking and Struck Tools, 27 Pliers, 32 Screwdrivers, 139 Miscellaneous Tools.
- › Modules contained: JCS-MAS-1, JCS-MAS-2, JCS-MAS-3, JCS-MAS-4, JCS-MAS-5, JCS-MOD833.
- › Enhanced version of Proto® J99940 Master Technician Maintenance Set.
- › Weight: 356.0 lbs.



Representative Image; Contents May Differ





| Contents | Description |
|-----------------|-------------------------------------|
| J4770A | Adapter, Universal Joint 1/4" DR |
| J5270A | Adapter, Universal Joint 3/8" DR |
| J5470A | Adapter, Universal Joint 1/2" DR |
| J5670 | Adapter, Universal Joint 3/4" DR |
| J2126 | Bar, 12" Long 1/2" Tip |
| J2130 | Bar, 16" Long 5/8" Tip |
| J2120 | Bar, Pry Aligning 18" |
| J2124 | Bar, Pry Aligning 24" |
| 9000-10 | Bit, 1/4" x 1" |
| 9000-8 | Bit, for P1 1/4" x 1" |
| 9000-9 | Bit, for P2 1/4" x 1" |
| J6931 | Bit, Holder Power 3/8" DR 1/4" Hex |
| J6930 | Bit, Holder Power 3/8" DR 5/16" Hex |
| J60002 | Bit, Insert #1 Phillips® 1/4" Hex |
| J60050 | Bit, Insert #1 Phillips® 5/16" Hex |
| J60008 | Bit, Insert #2 Phillips® 1/4" Hex |
| J60052 | Bit, Insert #2 Phillips® 5/16" Hex |
| J60020 | Bit, Insert #3 Phillips® 1/4" Hex |
| J60054 | Bit, Insert #3 Phillips® 5/16" Hex |
| J60202 | Bit, Insert 3/16" Slotted 1/4" Hex |
| J60208 | Bit, Insert 9/32" Slotted 1/4" Hex |
| J60256 | Bit, Insert 10F-12R Slot 5/16" Hex |
| J60262 | Bit, Insert 14F-16R Slot 5/16" Hex |
| 9000-6 | Bit, Insert Slotted 3/16" #4 |
| 9000-7 | Bit, Insert Slotted 1/4" x 7/8" |
| 9000-11 | Bit, Insert Slotted 5/16" x 1-1/2" |
| 9000-12 | Bit, Insert Slotted 5/16" x 1-1/2" |
| J4019 | Box, for Puller Set |
| J404 | C-Clamps, Capacity 0"-4", 2 Each |
| J86A3/16 | Chisel, Cold 1/4" |
| J86A1/4 | Chisel, Cold 5/16" |
| J86A5/16 | Chisel, Cold 3/8" |
| J86A7/16 | Chisel, Cold 1/2" |
| J86A1/2 | Chisel, Cold 5/8" |
| J86A5/8 | Chisel, Cold 3/4" |
| J86A3/4X8 | Chisel, Cold 7/8" |
| J86A7/8X8 | Chisel, Cold 1" |
| J86A1X8 | Chisel, Cold 1-3/16" |
| J4769 | Driver, 1/4" DR |
| J9521 | Extractor, Screw 1/8" |
| J9522 | Extractor, Screw 3/16" |
| J9523 | Extractor, Screw 15/64" |
| J9524 | Extractor, Screw 5/16" |
| J9525 | Extractor, Screw 3/8" |
| J9525B | Extractor, Screw 15/32" |
| J9526 | Extractor, Screw 9/16" |
| J9527 | Extractor, Screw 21/32" |
| J9528 | Extractor, Screw 13/16" |
| J9529 | Extractor, Screw 1-1/16" |
| J4759 | Extension, 1/4" DR 2" |
| J4760 | Extension, 1/4" DR 3" |
| J4761 | Extension, 1/4" DR 6" |
| J5260 | Extension, 3/8" DR 3" |
| J5260-06 | Extension, 3/8" DR 6" |
| J5262 | Extension, 3/8" DR 12" |
| J5460 | Extension, 1/2" DR 2-1/2" |
| J5461 | Extension, 1/2" DR 5" |
| J5463 | Extension, 1/2" DR 10" |

| Contents | Description |
|-----------------|--|
| J5660 | Extension, 3/4" DR 4" |
| J5661 | Extension, 3/4" DR 8" |
| J5663 | Extension, 3/4" DR 16" |
| J4765 | Extension, Flex 1/4" DR 6-1/4" |
| J5268 | Extension, Flex 3/8" DR 8" |
| J5260W | Extension, Wobble 3/8" DR 3" |
| J5260-06W | Extension, Wobble 3/8" DR 6" |
| 15-265 | Hacksaw, 3-7/8" |
| J1430-HB | Hammer Head |
| J1308PD | Hammer, Ball Pein 8 oz. |
| J1316PD | Hammer, Ball Pein 16 oz. |
| J1332PD | Hammer, Ball Pein 32 oz. |
| 57-532 | Hammer, Compo-Cast® 21 oz. |
| 57-534 | Hammer, Compo-Cast® 52 oz. |
| J4780G | Handle, Speed 1/4 DR |
| J5280G | Handle, Speed 3/8 DR |
| J5480G | Handle, Speed 1/2 DR |
| J4766 | Handle, Hinge 1/4" DR 5-3/4" |
| J5265 | Handle, Hinge 3/8" DR 8-1/2" |
| J5468 | Handle, Hinge 1/2" DR |
| J5668 | Handle, Hinge 3/4" DR 20" |
| J4785 | Handle, Sliding T 1/4" DR |
| J5285 | Handle, Sliding T 3/8" DR |
| J5485 | Handle, Sliding T 1/2" DR |
| J5685 | Handle, Sliding T 3/4" DR |
| J4984 | Hex Key, 9 PC Metric Set |
| J4980 | Hex Key, 13 PC Standard Set |
| J2108 | Holder, Punch and Chisel |
| J7099 | Impact, Hand Driver 3/8" |
| J95218 | Knife, Folding Blade |
| J18545B | Knife, Lockback 5" |
| J1368 | Mallet, Rubber |
| J2373 | Mirror, Rectangular Telescoping 2-1/8" |
| J9206 | Nut Driver, 3/16" |
| J9207 | Nut Driver, 7/32" |
| J9208 | Nut Driver, 1/4" |
| J9210 | Nut Driver, 5/16" |
| J9209 | Nut Driver, 9/32" |
| J9212 | Nut Driver, 3/8" |
| J9214 | Nut Driver 7/16" |
| J9216 | Nut Driver, 1/2" |
| J9218 | Nut Driver, 9/16" |
| J9211 | Nut Driver, 11/32" |
| J9220 | Nut Driver, 5/8" |
| J9204M | Nut Driver, 4 mm |
| J9205M | Nut Driver, 5 mm |
| J92055M | Nut Driver, 5.5 mm |
| J9206M | Nut Driver, 6 mm |
| J9207M | Nut Driver, 7 mm |
| J9208M | Nut Driver, 8 mm |
| J9209M | Nut Driver, 9 mm |
| J9210M | Nut Driver, 10 mm |
| J9211M | Nut Driver, 11 mm |
| J9213M | Nut Driver, 13 mm |
| J9214M | Nut Driver, 14 mm |
| J206G | Pliers, Diagonal Cutting with Grip 6-1/16" |
| J209G | Pliers, Diagonal Cutting with Grip 7-5/16" |
| J227G | Pliers, Duckbill with Grip 7-25/32" |

(CONTINUED ON NEXT PAGE)

833 PC MASTER TECHNICIAN MAINTENANCE SET (CONTINUED)

Product #: **JCS-0833MAS**



| Contents | Description | Contents | Description |
|----------|--|--------------|--|
| J272G | Pliers, End Cutting High Leverage 8-1/4" | J963/8 | Punch, Drift 3/16" |
| J268G | Pliers, Lineman's with Grip 8-5/8" | J961/2 | Punch, Drift 1/4" |
| J292NC | Pliers, Locking Curved 10" | J475/16X1/8 | Punch, Pin 1/8" |
| J286LNXL | Pliers, Locking Mini Long Nose 6-29/32" | J473/8X3/16 | Punch, Pin 3/16" |
| J291NC | Pliers, Locking Straight 7" | J471/2X1/4 | Punch, Pin 1/4" |
| J225G | Pliers, Needle-Nose Bent Nose 6-5/16" | J471/4X3/32 | Punch, Pin 3/32" |
| J222G | Pliers, Needle-Nose Long Thin 6-1/16" | J475/16X5/32 | Punch, Pin 5/32" |
| J226G | Pliers, Needle-Nose with Cutter 6-5/8" | J477/16X7/32 | Punch, Pin 7/32" |
| J360A | Pliers, 6 PC Retaining Ring Set | J445/16 | Punch, Prick 5/16" |
| J276G | Pliers, Slip-Joint with Grip 6-9/16" | J505/16 | Punch, Starting 1/8" |
| J278G | Pliers, Slip-Joint with Grip 8-1/16" | J501/4 | Punch, Starting 3/32" |
| J261SG | Pliers, Tongue and Groove 5" with Grip | J503/8 | Punch, Starting 3/16" |
| J262SG | Pliers, Tongue and Groove 6-1/2" with Grip | J507/16 | Punch, Starting 7/32" |
| J260SG | Pliers, Tongue and Groove 10-3/16" with Grip | J501/2 | Punch, Starting 1/4" |
| J265SG | Pliers, Tongue and Groove 16" with Grip | J4749 | Ratchet, 1/4" DR |
| J298 | Pliers, Wire Strippers 8-1/4" | J5249 | Ratchet, 3/8" DR |
| J4209JB | Puller, 6 Ton Jaw Block | J5449 | Ratchet, 1/2" DR |
| J4210RJ | Puller, 6 Ton Jaw Reversible | J5450 | Ratchet, 1/2" DR (Long Handle) |
| J4229JB | Puller, 10 Ton Jaw Block | J5649 | Ratchet, 3/4" DR |
| J4280B | Puller, Blind Bearing Coll | J5247 | Ratchet Adapter 3/8" DR 2-1/16" |
| J2306 | Puller, Cotter Pin Tool | J5447 | Ratchet Adapter 1/2" DR 2-21/32" |
| J4227CA | Puller, Crossarm 3 Way | J5257F | Ratchet, 3/8" DR Flex-Head 2-1/16" |
| J4208CA | Puller, Crossarm 6 Ton 2 Way | J5457F | Ratchet, 1/2" DR Flex-Head 17-3/32" |
| J4260R | Puller, Handle T-Rod Acme | J2375 | Retrieval Tool, Pocket Magnetic |
| J4230RJ | Puller, Jaw 10 Ton Reversible | 28-240 | Scraper, Flexible Nylon 1-1/4" |
| J4209LS | Puller, Jaw Block Lock Screw | 28-540 | Scraper, Flexible 1-1/4" Wood Handle |
| J4056-4 | Puller, Jaw Reversible 4 R | J2336 | Scrapers, Gasket and Carbon |
| J4250N | Puller, Nut Adjustable Reversible | J9884 | Screw Starter, Phillips® Tip |
| J4331N | Puller, Nut Hex | J9853 | Screw Starter, Standard Tip |
| J4333N | Puller, Nut Hex | J88203 | Screwdriver, Slotted Cabinet, Round 1/8" x 3" |
| J4056PN | Puller, Pin Pivot | J88204 | Screwdriver, Slotted Cabinet, Round 1/8" x 4" |
| J4275R | Puller, Rod Slide Acme Threader | J88208 | Screwdriver, Slotted Cabinet, Round 1/8" x 8" |
| J4333AR | Puller, Rod Threader 3/4"-1" | J88214 | Screwdriver, Slotted Cabinet, Round 3/16" x 4" |
| J4331R | Puller, Screw Cap | J88218 | Screwdriver, Slotted Cabinet, Round 3/16" x 8" |
| J4205S | Puller, Screw Forcing Acme | J88393 | Screwdriver, Phillips® #0 |
| J4331P | Puller, Separator Plate | J88313 | Screwdriver, Phillips® #1 |
| J4333P | Puller, Separator Plate | J88318 | Screwdriver, Phillips® #1 |
| J4260H | Puller, Slide Hammer 2-1/2" | J88322 | Screwdriver, Phillips® #2 |
| J4055H | Puller, Slide Hammer 5 lbs. | J88324 | Screwdriver, Phillips® #2 |
| J4040-1 | Puller, Step Plate 3/4" | J88328 | Screwdriver, Phillips® #2 |
| J4040-2 | Puller, Step Plate 7/8" | J88336 | Screwdriver, Phillips® #3 |
| J4040-3 | Puller, Step Plate 1" | J88348 | Screwdriver, Phillips® #4 |
| J4040-4 | Puller, Step Plate 1-1/8" | J88102 | Screwdriver, Slotted Keystone, Square 1/4" x 2" |
| J4040-6 | Puller, Step Plate 1-3/8" | J88104 | Screwdriver, Slotted Keystone, Square 1/4" x 4" |
| J4040-5 | Puller, Step Plate 1-1/4" | J88106 | Screwdriver, Slotted Keystone, Square 1/4" x 6" |
| J4040-8 | Puller, Step Plate 1-5/8" | J88108 | Screwdriver, Slotted Keystone, Square 1/4" x 8" |
| J4040-7 | Puller, Step Plate 1-1/2" | J88112 | Screwdriver, Slotted Keystone, Square 1/4" x 12" |
| J4040-9 | Puller, Step Plate 1-3/4" | J88002 | Screwdriver, Slotted Keystone, Round 1/4" x 1-1/2" |
| J4040-10 | Puller, Step Plate 1-7/8" | J322 | Snips, Straight 12-3/4" |
| J4040-11 | Puller, Step Plate 2" | J303S | Snips, Aviation Straight |
| J4012T | Puller, Tip Detachable | J308 | Snips, Miniature |
| J4022T | Puller, Tip Detachable Standard | J4707 | Socket, 1/4" DR 7/32" 6 PT |
| J4255B | Puller, Yoke 3 Way Jaw ACM | J4708 | Socket, 1/4" DR 1/4" 6 PT |
| J413/8 | Punch, Center 3/8" | J4710 | Socket, 1/4" DR 5/16" 6 PT |
| J411/2 | Punch, Center 1/2" | J4712 | Socket, 1/4" DR 3/8" 6 PT |
| J965/16 | Punch, Drift 1/8" | J4709 | Socket, 1/4" DR 9/32" 6 PT |





| Contents | Description |
|-----------------|-----------------------------------|
| J4716 | Socket, 1/4" DR 1/2" 6 PT |
| J4718 | Socket, 1/4" DR 9/16" 6 PT |
| J4711 | Socket, 1/4" DR 11/32" 6 PT |
| J4706 | Socket, 1/4" DR 3/16" 6 PT |
| J4714 | Socket, 1/4" DR 7/16" 6 PT |
| J4704M | Socket, 1/4" DR 4 mm 6 PT |
| J4705M | Socket, 1/4" DR 5 mm 6 PT |
| J47055M | Socket, 1/4" DR 5.5 mm 6 PT |
| J4706M | Socket, 1/4" DR 6 mm 6 PT |
| J4707M | Socket, 1/4" DR 7 mm 6 PT |
| J4708M | Socket, 1/4" DR 8 mm 6 PT |
| J4709M | Socket, 1/4" DR 9 mm 6 PT |
| J4710M | Socket, 1/4" DR 10 mm 6 PT |
| J4711M | Socket, 1/4" DR 11 mm 6 PT |
| J4712M | Socket, 1/4" DR 12 mm 6 PT |
| J4713M | Socket, 1/4" DR 13 mm 6 PT |
| J4714M | Socket, 1/4" DR 14 mm 6 PT |
| J4706L | Socket, 1/4" DR 3/16" 6 PT Deep |
| J4707L | Socket, 1/4" DR 7/32" 6 PT Deep |
| J4708L | Socket, 1/4" DR 1/4" 6 PT Deep |
| J4709L | Socket, 1/4" DR 9/32" 6 PT Deep |
| J4710L | Socket, 1/4" DR 5/16" 6 PT Deep |
| J4711L | Socket, 1/4" DR 11/32" 6 PT Deep |
| J4712L | Socket, 1/4" DR 3/8" 6 PT Deep |
| J4714L | Socket, 1/4" DR 7/16" 6 PT Deep |
| J4716L | Socket, 1/4" DR 1/2" 6 PT Deep |
| J4718L | Socket, 1/4" DR 9/16" 6 PT Deep |
| J4704LM | Socket, 1/4" DR 4 mm 6 PT Deep |
| J4705LM | Socket, 1/4" DR 5 mm 6 PT Deep |
| J47055LM | Socket, 1/4" DR 5.5 mm 6 PT Deep |
| J4706LM | Socket, 1/4" DR 6 mm 6 PT Deep |
| J4707LM | Socket, 1/4" DR 7 mm 6 PT Deep |
| J4708LM | Socket, 1/4" DR 8 mm 6 PT Deep |
| J4709LM | Socket, 1/4" DR 9 mm 6 PT Deep |
| J4710LM | Socket, 1/4" DR 10 mm 6 PT Deep |
| J4711LM | Socket, 1/4" DR 11 mm 6 PT Deep |
| J4712LM | Socket, 1/4" DR 12 mm 6 PT Deep |
| J4713LM | Socket, 1/4" DR 13 mm 6 PT Deep |
| J4714LM | Socket, 1/4" DR 14 mm 6 PT Deep |
| J4708S | Socket, 1/4" DR 1/4" 8 PT |
| J4712S | Socket, 1/4" DR 3/8" 8 PT |
| J4710S | Socket, 1/4" DR 5/16" 8 PT |
| J4705LTM | Socket, 1/4" DR 5 mm 12 PT Deep |
| J47055LTM | Socket, 1/4" DR 5.5 mm 12 PT Deep |
| J4706LTM | Socket, 1/4" DR 6 mm 12 PT Deep |
| J4707LTM | Socket, 1/4" DR 7 mm 12 PT Deep |
| J4708LTM | Socket, 1/4" DR 8 mm 12 PT Deep |
| J4709LTM | Socket, 1/4" DR 9 mm 12 PT Deep |
| J4710LTM | Socket, 1/4" DR 10 mm 12 PT Deep |
| J4711LTM | Socket, 1/4" DR 11 mm 12 PT Deep |
| J4712LTM | Socket, 1/4" DR 12 mm 12 PT Deep |
| J4713LTM | Socket, 1/4" DR 13 mm 12 PT Deep |
| J4714LTM | Socket, 1/4" DR 14 mm 12 PT Deep |
| J5208S | Socket, 3/8" DR 1/4" 8 PT |
| J5210S | Socket, 3/8" DR 5/16" 8 PT |
| J5212S | Socket, 3/8" DR 3/8" 8 PT |
| J5214S | Socket, 3/8" DR 7/16" 8 PT |
| J5216S | Socket, 3/8" DR 1/2" 8 PT |

| Contents | Description |
|-----------------|-----------------------------------|
| J5208 | Socket, 3/8" DR 1/4" 12 PT |
| J5210 | Socket, 3/8" DR 5/16" 12 PT |
| J5212 | Socket, 3/8" DR 3/8" 12 PT |
| J5214 | Socket, 3/8" DR 7/16" 12 PT |
| J5216 | Socket, 3/8" DR 1/2" 12 PT |
| J5218 | Socket, 3/8" DR 9/16" 12 PT |
| J5220 | Socket, 3/8" DR 5/8" 12 PT |
| J5222 | Socket, 3/8" DR 11/16" 12 PT |
| J5224 | Socket, 3/8" DR 3/4" 12 PT |
| J5226 | Socket, 3/8" DR 13/16" 12 PT |
| J5228 | Socket, 3/8" DR 7/8" 12 PT |
| J5230 | Socket, 3/8" DR 15/16" 12 PT |
| J5232 | Socket, 3/8" DR 1" 12 PT |
| J5208M | Socket, 3/8" DR 8 mm 12 PT |
| J5209M | Socket, 3/8" DR 9 mm 12 PT |
| J5210M | Socket, 3/8" DR 10 mm 12 PT |
| J5211M | Socket, 3/8" DR 11 mm 12 PT |
| J5212M | Socket, 3/8" DR 12 mm 12 PT |
| J5213M | Socket, 3/8" DR 13 mm 12 PT |
| J5214M | Socket, 3/8" DR 14 mm 12 PT |
| J5215M | Socket, 3/8" DR 15 mm 12 PT |
| J5216M | Socket, 3/8" DR 16 mm 12 PT |
| J5217M | Socket, 3/8" DR 17 mm 12 PT |
| J5218M | Socket, 3/8" DR 18 mm 12 PT |
| J5219M | Socket, 3/8" DR 19 mm 12 PT |
| J5008 | Socket, 3/8" DR 1/4" 12 PT Deep |
| J5010 | Socket, 3/8" DR 5/16" 12 PT Deep |
| J5012 | Socket, 3/8" DR 3/8" 12 PT Deep |
| J5016 | Socket, 3/8" DR 1/2" 12 PT Deep |
| J5020 | Socket, 3/8" DR 5/8" 12 PT Deep |
| J5014 | Socket, 3/8" DR 7/16" 12 PT Deep |
| J5018 | Socket, 3/8" DR 9/16" 12 PT Deep |
| J5022 | Socket, 3/8" DR 11/16" 12 PT Deep |
| J5024 | Socket, 3/8" DR 3/4" 12 PT Deep |
| J5026 | Socket, 3/8" DR 13/16" 12 PT Deep |
| J5028 | Socket, 3/8" DR 7/8" 12 PT Deep |
| J5030 | Socket, 3/8" DR 15/16" 12 PT Deep |
| J5032 | Socket, 3/8" DR 1" 12 PT Deep |
| J5008M | Socket, 3/8" DR 8 mm 12 PT Deep |
| J5009M | Socket, 3/8" DR 9 mm 12 PT Deep |
| J5010M | Socket, 3/8" DR 10 mm 12 PT Deep |
| J5011M | Socket, 3/8" DR 11 mm 12 PT Deep |
| J5012M | Socket, 3/8" DR 12 mm 12 PT Deep |
| J5013M | Socket, 3/8" DR 13 mm 12 PT Deep |
| J5014M | Socket, 3/8" DR 14 mm 12 PT Deep |
| J5015M | Socket, 3/8" DR 15 mm 12 PT Deep |
| J5016M | Socket, 3/8" DR 16 mm 12 PT Deep |
| J5017M | Socket, 3/8" DR 17 mm 12 PT Deep |
| J5018M | Socket, 3/8" DR 18 mm 12 PT Deep |
| J5019M | Socket, 3/8" DR 19 mm 12 PT Deep |
| J5412S | Socket, 1/2" DR 3/8" 8 PT |
| J5414S | Socket, 1/2" DR 7/16" 8 PT |
| J5416S | Socket, 1/2" DR 1/2" 8 PT |
| J5418S | Socket, 1/2" DR 9/16" 8 PT |
| J5420S | Socket, 1/2" DR 5/8" 8 PT |
| J5422S | Socket, 1/2" DR 11/16" 8 PT |
| J5424S | Socket, 1/2" DR 3/4" 8 PT |
| J5426S | Socket, 1/2" DR 13/16" 8 PT |

(CONTINUED ON NEXT PAGE)

833 PC MASTER TECHNICIAN MAINTENANCE SET (CONTINUED)

Product #: **JCS-0833MAS**



| Contents | Description | Contents | Description |
|----------|------------------------------------|-----------|---|
| J5428S | Socket, 1/2" DR 7/8" 8 PT | J5315M | Socket, 1/2" DR 15 mm 12 PT Deep |
| J5432S | Socket, 1/2" DR 1" 8 PT | J5316M | Socket, 1/2" DR 16 mm 12 PT Deep |
| J5412 | Socket, 1/2" DR 3/8" 12 PT | J5317M | Socket, 1/2" DR 17 mm 12 PT Deep |
| J5414 | Socket, 1/2" DR 7/16" 12 PT | J5318M | Socket, 1/2" DR 18 mm 12 PT Deep |
| J5416 | Socket, 1/2" DR 1/2" 12 PT | J5319M | Socket, 1/2" DR 19 mm 12 PT Deep |
| J5418 | Socket, 1/2" DR 9/16" 12 PT | J5320M | Socket, 1/2" DR 20 mm 12 PT Deep |
| J5422 | Socket, 1/2" DR 11/16" 12 PT | J5321M | Socket, 1/2" DR 21 mm 12 PT Deep |
| J5426 | Socket, 1/2" DR 13/16" 12 PT | J5322M | Socket, 1/2" DR 22 mm 12 PT Deep |
| J5430 | Socket, 1/2" DR 15/16" 12 PT | J5323M | Socket, 1/2" DR 23 mm 12 PT Deep |
| J5419 | Socket, 1/2" DR 19/32" 12 PT | J5324M | Socket, 1/2" DR 24 mm 12 PT Deep |
| J5420 | Socket, 1/2" DR 5/8" 12 PT | J5444A | Socket, 1/2" DR Drag Link 3/4" |
| J5424 | Socket, 1/2" DR 3/4" 12 PT | J5446A | Socket, 1/2" DR Drag Link 15/16" |
| J5425 | Socket, 1/2" DR 25/32" 12 PT | J5528 | Socket, 3/4" DR 7/8" 12 PT |
| J5428 | Socket, 1/2" DR 7/8" 12 PT | J5534 | Socket, 3/4" DR 1-1/16" 12 PT |
| J5429 | Socket, 1/2" DR 29/32" 12 PT | J5548 | Socket, 3/4" DR 1-1/2" 12 PT |
| J5432 | Socket, 1/2" DR 1" 12 PT | J5540 | Socket, 3/4" DR 1-1/4" 12 PT |
| J5434 | Socket, 1/2" DR 1-1/16" 12 PT | J5536 | Socket, 3/4" DR 1-1/8" 12 PT |
| J5436 | Socket, 1/2" DR 1-1/8" 12 PT | J5554 | Socket, 3/4" DR 1-11/16" 12 PT |
| J5438 | Socket, 1/2" DR 1-3/16" 12 PT | J5558 | Socket, 3/4" DR 1-13/16" 12 PT |
| J5440 | Socket, 1/2" DR 1-1/4" 12 PT | J5538 | Socket, 3/4" DR 1-3/16" 12 PT |
| J5442 | Socket, 1/2" DR 1-5/16" 12 PT | J5556 | Socket, 3/4" DR 1-3/4" 12 PT |
| J5444 | Socket, 1/2" DR 1-3/8" 12 PT | J5544 | Socket, 3/4" DR 1-3/8" 12 PT |
| J5446 | Socket, 1/2" DR 1-7/16" 12 PT | J5542 | Socket, 3/4" DR 1-5/16" 12 PT |
| J5448 | Socket, 1/2" DR 1-1/2" 12 PT | J5552 | Socket, 3/4" DR 1-5/8" 12 PT |
| J5410M | Socket, 1/2" DR 10 mm 12 PT | J5546 | Socket, 3/4" DR 1-7/16" 12 PT |
| J5411M | Socket, 1/2" DR 11 mm 12 PT | J5560 | Socket, 3/4" DR 1-7/8" 12 PT |
| J5412M | Socket, 1/2" DR 12 mm 12 PT | J5550 | Socket, 3/4" DR 1-9/16" 12 PT |
| J5413M | Socket, 1/2" DR 13 mm 12 PT | J5532 | Socket, 3/4" DR 1" 12 PT |
| J5414M | Socket, 1/2" DR 14 mm 12 PT | J5530 | Socket, 3/4" DR 15/16" 12 PT |
| J5415M | Socket, 1/2" DR 15 mm 12 PT | J5572 | Socket, 3/4" DR 2-1/4" 12 PT |
| J5416M | Socket, 1/2" DR 16 mm 12 PT | J5568 | Socket, 3/4" DR 2-1/8" 12 PT |
| J5417M | Socket, 1/2" DR 17 mm 12 PT | J5570 | Socket, 3/4" DR 2-3/16" 12 PT |
| J5418M | Socket, 1/2" DR 18 mm 12 PT | J5576 | Socket, 3/4" DR 2-3/8" 12 PT |
| J5419M | Socket, 1/2" DR 19 mm 12 PT | J5564 | Socket, 3/4" DR 2" 12 PT |
| J5420M | Socket, 1/2" DR 20 mm 12 PT | J4738 | Socket, Bit 1/4" DR #2 Phillips® |
| J5421M | Socket, 1/2" DR 21 mm 12 PT | J4737 | Socket, Bit 1/4" DR #1 Phillips® |
| J5422M | Socket, 1/2" DR 22 mm 12 PT | J4743 | Socket, Bit 1/4" DR Slotted 1/4" 1-3/16" |
| J5423M | Socket, 1/2" DR 23 mm 12 PT | J4744 | Socket, Bit 1/4" DR Slotted 3/16" |
| J5424M | Socket, 1/2" DR 24 mm 12 PT | J4745 | Socket, Bit 1/4" DR Slotted 1/4" 1-13/64" |
| J5316 | Socket, 1/2" DR 1/2" 12 PT Deep | J5241 | Socket, Bit 3/8" DR #2 Phillips® |
| J5318 | Socket, 1/2" DR 9/16" 12 PT Deep | J5242 | Socket, Bit 3/8" DR #3 Phillips® |
| J5320 | Socket, 1/2" DR 5/8" 12 PT Deep | J5243 | Socket, Bit 3/8" DR #4 Phillips® |
| J5322 | Socket, 1/2" DR 11/16" 12 PT Deep | J5246 | Socket, Bit 3/8" DR Slotted |
| J5324 | Socket, 1/2" DR 3/4" 12 PT Deep | J69X09 | Socket, Extractor 1/4" DR 7 mm |
| J5326 | Socket, 1/2" DR 13/16" 12 PT Deep | J69X10 | Socket, Extractor 1/4" DR 8 mm |
| J5328 | Socket, 1/2" DR 7/8" 12 PT Deep | J69X11 | Socket, Extractor 1/4" DR 9 mm |
| J5330 | Socket, 1/2" DR 15/16" 12 PT Deep | J69X13 | Socket, Extractor 1/4" DR 10 mm |
| J5332 | Socket, 1/2" DR 1" 12 PT Deep | J69X14 | Socket, Extractor 1/4" DR 11 mm |
| J5334 | Socket, 1/2" DR 1-1/16" 12 PT Deep | J69X15 | Socket, Extractor 1/4" DR 12 mm |
| J5336 | Socket, 1/2" DR 1-1/8" 12 PT Deep | J69X16 | Socket, Extractor 1/4" DR 13 mm |
| J5340 | Socket, 1/2" DR 1-1/4" 12 PT Deep | J69X18 | Socket, Extractor 1/4" DR 14 mm |
| J5310M | Socket, 1/2" DR 10 mm 12 PT Deep | J69X20 | Socket, Extractor 1/4" DR 15 mm |
| J5311M | Socket, 1/2" DR 11 mm 12 PT Deep | J69X12 | Socket, Extractor 3/8" |
| J5312M | Socket, 1/2" DR 12 mm 12 PT Deep | J47701/16 | Socket, Hex Bit 1/4" DR 1/16" |
| J5313M | Socket, 1/2" DR 13 mm 12 PT Deep | J47705/64 | Socket, Hex Bit 1/4" DR 5/64" |
| J5314M | Socket, 1/2" DR 14 mm 12 PT Deep | J47703/32 | Socket, Hex Bit 1/4" DR 3/32" |





| Contents | Description |
|------------|--|
| J47707/64 | Socket, Hex Bit 1/4" DR 7/64" |
| J47701/8 | Socket, Hex Bit 1/4" DR 1/8" |
| J47709/64 | Socket, Hex Bit 1/4" DR 9/64" |
| J47705/32 | Socket, Hex Bit 1/4" DR 5/32" |
| J47703/16 | Socket, Hex Bit 1/4" DR 3/16" |
| J47701/4 | Socket, Hex Bit 1/4" DR 1/4" |
| J47707/32 | Socket, Hex Bit 1/4" DR 7/32" |
| J47705/16 | Socket, Hex Bit 1/4" DR 5/16" |
| J4770-2M | Socket, Hex Bit 1/4" DR 2 mm |
| J4770-2.5M | Socket, Hex Bit 1/4" DR 2.5 mm |
| J4770-3M | Socket, Hex Bit 1/4" DR 3 mm |
| J4770-4M | Socket, Hex Bit 1/4" DR 4 mm |
| J4770-5M | Socket, Hex Bit 1/4" DR 5 mm |
| J4770-6M | Socket, Hex Bit 1/4" DR 6 mm |
| J49901/8 | Socket, Hex Bit 3/8" DR 1/8" |
| J49905/32 | Socket, Hex Bit 3/8" DR 5/32" |
| J49903/16 | Socket, Hex Bit 3/8" DR 3/16" |
| J49907/32 | Socket, Hex Bit 3/8" DR 7/32" |
| J49901/4 | Socket, Hex Bit 3/8" DR 1/4" |
| J49905/16 | Socket, Hex Bit 3/8" DR 5/16" |
| J49903/8 | Socket, Hex Bit 3/8" DR 3/8" |
| J4990-4M | Socket, Hex Bit 3/8" DR 4 mm |
| J4990-5M | Socket, Hex Bit 3/8" DR 5 mm |
| J4990-6M | Socket, Hex Bit 3/8" DR 6 mm |
| J4990-7M | Socket, Hex Bit 3/8" DR 7 mm |
| J4990-8M | Socket, Hex Bit 3/8" DR 8 mm |
| J4990-9M | Socket, Hex Bit 3/8" DR 9 mm |
| J4990-10M | Socket, Hex Bit 3/8" DR 10 mm |
| J54411/4 | Socket, Hex Bit 1/2" DR 1/4" |
| J54415/16 | Socket, Hex Bit 1/2" DR 5/16" |
| J54413/8 | Socket, Hex Bit 1/2" DR 3/8" |
| J54417/16 | Socket, Hex Bit 1/2" DR 7/16" |
| J54411/2 | Socket, Hex Bit 1/2" DR 1/2" |
| J54419/16 | Socket, Hex Bit 1/2" DR 9/16" |
| J54415/8 | Socket, Hex Bit 1/2" DR 5/8" |
| J5441-12M | Socket, Hex Bit 1/2" DR 12 mm |
| J5441-14M | Socket, Hex Bit 1/2" DR 14 mm |
| J5441-17M | Socket, Hex Bit 1/2" DR 17 mm |
| J7208H | Socket, Impact 3/8" DR 1/4" 6 PT |
| J7209H | Socket, Impact 3/8" DR 9/32" 6 PT |
| J7210H | Socket, Impact 3/8" DR 5/16" 6 PT |
| J7211H | Socket, Impact 3/8" DR 11/32" 6 PT |
| J7212H | Socket, Impact 3/8" DR 3/8" 6 PT |
| J7214H | Socket, Impact 3/8" DR 7/16" 6 PT |
| J7216H | Socket, Impact 3/8" DR 1/2" 6 PT |
| J7218H | Socket, Impact 3/8" DR 9/16" 6 PT |
| J7220H | Socket, Impact 3/8" DR 5/8" 6 PT |
| J7222H | Socket, Impact 3/8" DR 11/16" 6 PT |
| J7224H | Socket, Impact 3/8" DR 3/4" 6 PT |
| J7226H | Socket, Impact 3/8" DR 13/16" 6 PT |
| J7228H | Socket, Impact 3/8" DR 7/8" 6 PT |
| J7230H | Socket, Impact 3/8" DR 15/16" 6 PT |
| J7232H | Socket, Impact 3/8" DR 1" 6 PT |
| J4770TA | Socket, Universal 1/4" DR 7/32" 12 PT |
| J4771TA | Socket, Universal 1/4" DR 1/4" 12 PT |
| J4777TA | Socket, Universal 1/4" DR 9/32" 12 PT |
| J4772TA | Socket, Universal 1/4" DR 5/16" 12 PT |
| J4778TA | Socket, Universal 1/4" DR 11/32" 12 PT |

| Contents | Description |
|----------|---|
| J4773TA | Socket, Universal 1/4" DR 3/8" 12 PT |
| J4774TA | Socket, Universal 1/4" DR 7/16" 12 PT |
| J4775TA | Socket, Universal 1/4" DR 1/2" 12 PT |
| J4776TA | Socket, Universal 1/4" DR 9/16" 12 PT |
| J5273HA | Socket, Universal 3/8" DR 3/8" 6 PT |
| J5274HA | Socket, Universal 3/8" DR 7/16" 6 PT |
| J5275HA | Socket, Universal 3/8" DR 1/2" 6 PT |
| J5276HA | Socket, Universal 3/8" DR 9/16" 6 PT |
| J5277HA | Socket, Universal 3/8" DR 5/8" 6 PT |
| J5278HA | Socket, Universal 3/8" DR 11/16" 6 PT |
| J5279HA | Socket, Universal 3/8" DR 3/4" 6 PT |
| J5273HAM | Socket, Universal 3/8" DR 10 mm 6 PT |
| J5274HAM | Socket, Universal 3/8" DR 11 mm 6 PT |
| J5275HAM | Socket, Universal 3/8" DR 12 mm 6 PT |
| J5276HAM | Socket, Universal 3/8" DR 13 mm 6 PT |
| J5277HAM | Socket, Universal 3/8" DR 14 mm 6 PT |
| J5278HAM | Socket, Universal 3/8" DR 15 mm 6 PT |
| J5279HAM | Socket, Universal 3/8" DR 16 mm 6 PT |
| J5280HAM | Socket, Universal 3/8" DR 17 mm 6 PT |
| J5281HAM | Socket, Universal 3/8" DR 18 mm 6 PT |
| J5282HAM | Socket, Universal 3/8" DR 19 mm 6 PT |
| J5273A | Socket, Universal 3/8" DR 3/8" 12 PT |
| J5274A | Socket, Universal 3/8" DR 7/16" 12 PT |
| J5275A | Socket, Universal 3/8" DR 1/2" 12 PT |
| J5276A | Socket, Universal 3/8" DR 9/16" 12 PT |
| J5277A | Socket, Universal 3/8" DR 5/8" 12 PT |
| J5278A | Socket, Universal 3/8" DR 11/16" 12 PT |
| J5279A | Socket, Universal 3/8" DR 3/4" 12 PT |
| J5475A | Socket, Universal 1/2" DR 1/2" 12 PT |
| J5476A | Socket, Universal 1/2" DR 9/16" 12 PT |
| J5477A | Socket, Universal 1/2" DR 5/8" 12 PT |
| 10-099 | Stanley® Classic 99® Retractable Blade Utility Knife |
| 68-768 | Tap and Die, 76 PC Set |
| 33-212 | Tape Rule, Stanley® Powerlock® with Metal Case 1/2" x 12' |
| J350 | Tubing Cutter |
| J351 | Tubing Flaring Tool |
| J706 | Wrench, Adjustable 6" |
| J708 | Wrench, Adjustable 8" |
| J710 | Wrench, Adjustable 10" |
| J712 | Wrench, Adjustable 12" |
| J715 | Wrench, Adjustable 15" |
| J3314 | Wrench, Angle 7/32" |
| J3316 | Wrench, Angle 1/4" |
| J3315 | Wrench, Angle 15/64" |
| J3318 | Wrench, Angle 9/32" |
| J3320 | Wrench, Angle 5/16" |
| J3322 | Wrench, Angle 11/32" |
| J3324 | Wrench, Angle 3/8" |
| J3112 | Wrench, Angle 3/8" |
| J3328 | Wrench, Angle 7/16" |
| J3114 | Wrench, Angle 7/16" |
| J3332 | Wrench, Angle 1/2" |
| J3116 | Wrench, Angle 1/2" |
| J3118 | Wrench, Angle 9/16" |
| J3120 | Wrench, Angle 5/8" |
| J3122 | Wrench, Angle 11/16" |
| J3126 | Wrench, Angle 13/16" |

(CONTINUED ON NEXT PAGE)



833 PC MASTER TECHNICIAN MAINTENANCE SET (CONTINUED)

Product #: JCS-0833MAS



| Contents | Description | Contents | Description |
|----------|--------------------------------------|-----------|--|
| J3124 | Wrench, Angle 3/4" | J1242 | Wrench, Combination 1-5/16" 12 PT |
| J3128 | Wrench, Angle 7/8" | J1244 | Wrench, Combination 1-3/8" 12 PT |
| J3130 | Wrench, Angle 15/16" | J1246 | Wrench, Combination 1-7/16" 12 PT |
| J3132 | Wrench, Angle 1" | J1248 | Wrench, Combination 1-1/2" 12 PT |
| J3134 | Wrench, Angle 1-1/16" | J1207MA | Wrench, Combination 7 mm 12 PT |
| J3136 | Wrench, Angle 1-1/8" | J1208MA | Wrench, Combination 8 mm 12 PT |
| J3140 | Wrench, Angle 1-1/4" | J1209MA | Wrench, Combination 9 mm 12 PT |
| J3109M | Wrench, Angle 9 mm | J1210MASD | Wrench, Combination 10 mm 12 PT |
| J3110M | Wrench, Angle 10 mm | J1211MASD | Wrench, Combination 11 mm 12 PT |
| J3111M | Wrench, Angle 11 mm | J1212MASD | Wrench, Combination 12 mm 12 PT |
| J3112M | Wrench, Angle 12 mm | J1213MASD | Wrench, Combination 13 mm 12 PT |
| J3113M | Wrench, Angle 13 mm | J1214MASD | Wrench, Combination 14 mm 12 PT |
| J3114M | Wrench, Angle 14 mm | J1215MASD | Wrench, Combination 15 mm 12 PT |
| J3115M | Wrench, Angle 15 mm | J1216MASD | Wrench, Combination 16 mm 12 PT |
| J3116M | Wrench, Angle 16 mm | J1217MASD | Wrench, Combination 17 mm 12 PT |
| J3117M | Wrench, Angle 17 mm | J1218MASD | Wrench, Combination 18 mm 12 PT |
| J3118M | Wrench, Angle 18 mm | J1219MASD | Wrench, Combination 19 mm 12 PT |
| J3119M | Wrench, Angle 19 mm | J1220MASD | Wrench, Combination 20 mm 12 PT |
| J1170 | Wrench, Box 5/16" x 3/8" 12 PT | J1221MASD | Wrench, Combination 21 mm 12 PT |
| J1171 | Wrench, Box 7/16" x 1/2" 12 PT | J1222MASD | Wrench, Combination 22 mm 12 PT |
| J1172 | Wrench, Box 9/16" x 5/8" 12 PT | J1223MASD | Wrench, Combination 23 mm 12 PT |
| J1173 | Wrench, Box 11/16" x 3/4" 12 PT | J1224MASD | Wrench, Combination 24 mm 12 PT |
| J1174 | Wrench, Box 13/16" x 7/8" 12 PT | J1204EF | Wrench, Combination 1/8" 6 PT Short |
| J1175 | Wrench, Box 15/16" x 1" 12 PT | J1205EF | Wrench, Combination 5/32" 6 PT Short |
| J1176 | Wrench, Box 1-1/16" x 1-1/8" 12 PT | J1206EF | Wrench, Combination 3/16" 6 PT Short |
| J1050M | Wrench, Box 6 x 7 mm 12 PT | J1208EF | Wrench, Combination 1/4" 6 PT Short |
| J1051M | Wrench, Box 8 x 9 mm 12 PT | J1209EF | Wrench, Combination 9/32" 6 PT Short |
| J1053M | Wrench, Box 10 x 11 mm 12 PT | J1210EF | Wrench, Combination 5/16" 6 PT Short |
| J1057M | Wrench, Box 12 x 13 mm 12 PT | J1211EF | Wrench, Combination 11/32" 6 PT Short |
| J1061M | Wrench, Box 14 x 15 mm 12 PT | J1212EF | Wrench, Combination 3/8" 6 PT Short |
| J1064M | Wrench, Box 16 x 18 mm 12 PT | J4912CF | Wrench, Crowfoot 3/8" DR 3/8" Open End |
| J1065M | Wrench, Box 17 x 19 mm 12 PT | J4914CF | Wrench, Crowfoot 3/8" DR 7/16" Open End |
| J1072M | Wrench, Box 21 x 24 mm 12 PT | J4916CF | Wrench, Crowfoot 3/8" DR 1/2" Open End |
| J1073M | Wrench, Box 22 x 24 mm 12 PT | J4918CF | Wrench, Crowfoot 3/8" DR 9/16" Open End |
| J1077M | Wrench, Box 27 x 30 mm 12 PT | J4920CF | Wrench, Crowfoot 3/8" DR 5/8" Open End |
| J1079M | Wrench, Box 30 x 32 mm 12 PT | J4922CF | Wrench, Crowfoot 3/8" DR 11/16" Open End |
| J1120 | Wrench, Box 5/16" x 3/8" 12 PT Short | J4924CF | Wrench, Crowfoot 3/8" DR 3/4" Open End |
| J1122 | Wrench, Box 3/8" x 7/16" 12 PT Short | J4926CF | Wrench, Crowfoot 3/8" DR 13/16" Open End |
| J1131 | Wrench, Box 5/8" x 3/4" 12 PT Short | J4928CF | Wrench, Crowfoot 3/8" DR 7/8" Open End |
| J1126 | Wrench, Box 1/2" x 9/16" 12 PT Short | J4909MCF | Wrench, Crowfoot 3/8" DR 9 mm Open End |
| J801 | Wrench, Chain | J4910MCF | Wrench, Crowfoot 3/8" DR 10 mm Open End |
| J1210A | Wrench, Combination 5/16" 12 PT | J4911MCF | Wrench, Crowfoot 3/8" DR 11 mm Open End |
| J1212ASD | Wrench, Combination 3/8" 12 PT | J4912MCF | Wrench, Crowfoot 3/8" DR 12 mm Open End |
| J1214ASD | Wrench, Combination 7/16" 12 PT | J4913MCF | Wrench, Crowfoot 3/8" DR 13 mm Open End |
| J1216ASD | Wrench, Combination 1/2" 12 PT | J4914MCF | Wrench, Crowfoot 3/8" DR 14 mm Open End |
| J1218ASD | Wrench, Combination 9/16" 12 PT | J4915MCF | Wrench, Crowfoot 3/8" DR 15 mm Open End |
| J1220ASD | Wrench, Combination 5/8" 12 PT | J4916MCF | Wrench, Crowfoot 3/8" DR 16 mm Open End |
| J1222ASD | Wrench, Combination 11/16" 12 PT | J4917MCF | Wrench, Crowfoot 3/8" DR 17 mm Open End |
| J1224ASD | Wrench, Combination 3/4" 12 PT | J4918MCF | Wrench, Crowfoot 3/8" DR 18 mm Open End |
| J1226ASD | Wrench, Combination 13/16" 12 PT | J4919MCF | Wrench, Crowfoot 3/8" DR 19 mm Open End |
| J1228ASD | Wrench, Combination 7/8" 12 PT | J4920MCF | Wrench, Crowfoot 3/8" DR 20 mm Open End |
| J1230ASD | Wrench, Combination 15/16" 12 PT | J4921MCF | Wrench, Crowfoot 3/8" DR 21 mm Open End |
| J1232ASD | Wrench, Combination 1" 12 PT | J4922MCF | Wrench, Crowfoot 3/8" DR 22 mm Open End |
| J1234ASD | Wrench, Combination 1-1/16" 12 PT | J4923MCF | Wrench, Crowfoot 3/8" DR 23 mm Open End |
| J1236ASD | Wrench, Combination 1-1/8" 12 PT | J4924MCF | Wrench, Crowfoot 3/8" DR 24 mm Open End |
| J1240ASD | Wrench, Combination 1-1/4" 12 PT | J5336FL | Wrench, Crowfoot 1/2" DR 1-1/8" |





| Contents | Description |
|-----------------|---|
| J5338FL | Wrench, Crowfoot 1/2" DR 1-3/16" |
| J5340FL | Wrench, Crowfoot 1/2" DR 1-1/4" |
| J5342FL | Wrench, Crowfoot 1/2" DR 1-5/16" |
| J5344FL | Wrench, Crowfoot 1/2" DR 1-3/8" |
| J5346FL | Wrench, Crowfoot 1/2" DR 1-7/16" |
| J5348FL | Wrench, Crowfoot 1/2" DR 1-1/2" |
| J5350FL | Wrench, Crowfoot 1/2" DR 1-9/16" |
| J5352FL | Wrench, Crowfoot 1/2" DR 1-5/8" |
| J5354FL | Wrench, Crowfoot 1/2" DR 1-11/16" |
| J5356FL | Wrench, Crowfoot 1/2" DR 1-3/4" |
| J5358FL | Wrench, Crowfoot 1/2" DR 1-13/16" |
| J5360FL | Wrench, Crowfoot 1/2" DR 1-7/8" |
| J3707M | Wrench, Flare Nut 7 mm x 8 mm |
| J3709M | Wrench, Flare Nut 9 mm x 11 mm |
| J3710M | Wrench, Flare Nut 10 mm x 12 mm |
| J3713M | Wrench, Flare Nut 13 mm x 14 mm |
| J3715M | Wrench, Flare Nut 15 mm x 17 mm |
| J3751 | Wrench, Flare Nut Combination 3/8" 6 PT |
| J3752 | Wrench, Flare Nut Combination 7/16" 6 PT |
| J3753 | Wrench, Flare Nut Combination 1/2" 6 PT |
| J3754 | Wrench, Flare Nut Combination 9/16" 6 PT |
| J3755 | Wrench, Flare Nut Combination 5/8" 6 PT |
| J3756 | Wrench, Flare Nut Combination 11/16" 6 PT |
| J3757 | Wrench, Flare Nut Combination 3/4" 6 PT |
| J3812 | Wrench, Flare Nut Ratcheting 3/8" |
| J3814 | Wrench, Flare Nut Ratcheting 7/16" |
| J3816 | Wrench, Flare Nut Ratcheting 1/2" |
| J3818 | Wrench, Flare Nut Ratcheting 9/16" |
| J3820 | Wrench, Flare Nut Ratcheting 5/8" |
| J3822 | Wrench, Flare Nut Ratcheting 11/16" |
| J3824 | Wrench, Flare Nut Ratcheting 3/4" |
| J1725 | Wrench, Obstruction 7/16" x 1/2" |
| J1730 | Wrench, Obstruction 9/16" x 5/8" |
| J1731 | Wrench, Obstruction 5/8" x 3/4" |
| J3018 | Wrench, Open End 1/4" x 5/16" |
| J3020 | Wrench, Open End 3/8" x 5/16" |
| J3025 | Wrench, Open End 7/16" x 1/2" |
| J3026 | Wrench, Open End 1/2" x 9/16" |

| Contents | Description |
|-----------------|--|
| J3030 | Wrench, Open End 9/16" x 5/8" |
| J3031 | Wrench, Open End 5/8" x 3/4" |
| J3035 | Wrench, Open End 11/16" x 3/4" |
| J3040 | Wrench, Open End 13/16" x 7/8" |
| J3045 | Wrench, Open End 15/16" x 1" |
| J3050 | Wrench, Open End 1-1/16" x 1-1/8" |
| J30607 | Wrench, Open End 6 mm x 7 mm |
| J30809 | Wrench, Open End 8 mm x 9 mm |
| J31011 | Wrench, Open End 10 mm x 11 mm |
| J31213 | Wrench, Open End 12 mm x 13 mm |
| J31415 | Wrench, Open End 14 mm x 15 mm |
| J31617 | Wrench, Open End 16 mm x 17 mm |
| J31819 | Wrench, Open End 18 mm x 19 mm |
| J32022 | Wrench, Open End 20 mm x 22 mm |
| J32123 | Wrench, Open End 21 mm x 23 mm |
| J32426 | Wrench, Open End 24 mm x 26 mm |
| J810HD | Wrench, Pipe Heavy-Duty 10" |
| J814HD | Wrench, Pipe Heavy-Duty 14" |
| J818HD | Wrench, Pipe Heavy-Duty 18" |
| J1191T-A | Wrench, Ratcheting Box 1/4" x 5/16" 12 PT |
| J1192T-A | Wrench, Ratcheting Box 3/8" x 7/16" 12 PT |
| J1193T-A | Wrench, Ratcheting Box 1/2" x 9/16" 12 PT |
| J1194-A | Wrench, Ratcheting Box 5/8" x 11/16" 12 PT |
| J1195-A | Wrench, Ratcheting Box 3/4" x 7/8" 12 PT |
| J1191M-A | Wrench, Ratcheting Box 7 mm x 8 mm |
| J1192M-A | Wrench, Ratcheting Box 9 mm x 10 mm |
| J1193MA-A | Wrench, Ratcheting Box 11 mm x 12 mm |
| J1194MA-A | Wrench, Ratcheting Box 13 mm x 14 mm |
| J1195M-A | Wrench, Ratcheting Box 15 mm x 17 mm |
| J1270-12 | Wrench, Swivel Combination 3/8" 12 PT |
| J1270-14 | Wrench, Swivel Combination 7/16" 12 PT |
| J1270-16 | Wrench, Swivel Combination 1/2" 12 PT |
| J1270-18 | Wrench, Swivel Combination 9/16" 12 PT |
| J1270-20 | Wrench, Swivel Combination 5/8" 12 PT |
| J1270-22 | Wrench, Swivel Combination 11/16" 12 PT |
| J1270-24 | Wrench, Swivel Combination 3/4" 12 PT |
| J6014C | Wrench, Torque 1/2" DR 50-250 ft-lbs |

833 PC MASTER TECHNICIAN MAINTENANCE SET WITH WORKSTATION J455041-10RD

Product #: JCS-0833MASBX1

- › 833 Pieces.
- › 1/4", 3/8", 1/2", 3/4" Drive tools.
- › Designed for fastener sizes 1/16" - 2-3/8", 2 mm - 24 mm.
- › Contains: 353 Sockets and Accessories, 205 Wrenches, 34 Striking and Struck Tools, 22 Pliers, 43 Screwdrivers, 176 Miscellaneous Tools.
- › Modules contained: JCS-MAS-1, JCS-MAS-2, JCS-MAS-3, JCS-MAS-4, JCS-MAS-5, JCS-MOD833.
- › Enhanced version of Proto® J99941 Master Technician's Set.
- › Weight: 831.0 lbs.



Representative Image; Contents May Differ



833 PC MASTER TECHNICIAN MAINTENANCE SET WITH WORKSTATION J445442-14RD

Product #: JCS-0833MASBX2

- › 833 Pieces.
- › 1/4", 3/8", 1/2", 3/4" Drive tools.
- › Designed for fastener sizes 1/16" - 2-3/8", 2 mm - 24 mm.
- › Contains: 353 Sockets and Accessories, 205 Wrenches, 34 Striking and Struck Tools, 22 Pliers, 43 Screwdrivers, 176 Miscellaneous Tools.
- › Modules contained: JCS-MAS-1, JCS-MAS-2, JCS-MAS-3, JCS-MAS-4, JCS-MAS-5, JCS-MOD833.
- › Enhanced version of Proto® J99942 Master Technician's Set.
- › Weight: 700.0 lbs.



Representative Image; Contents May Differ



613 PC MASTER TECHNICIAN MAINTENANCE SET

Product #: JCS-0613MAS



- › 613 Pieces.
- › 1/4", 3/8", 1/2", 3/4" Drive Tools.
- › Designed for fastener sizes 1/16" - 2-3/8", 2 mm - 24 mm.
- › Tools only.
- › Contains: 305 Sockets and Accessories, 170 Wrenches, 34 Striking and Struck Tools, 27 Pliers, 32 Screwdrivers, 45 Miscellaneous Tools.
- › Modules contained: JCS-MAS-1, JCS-MAS-2, JCS-MAS-3, JCS-MAS-4, JCS-MOD613.
- › Enhanced version of Proto® J99930 Master Technician Maintenance Set.
- › Weight: 338.0 lbs.

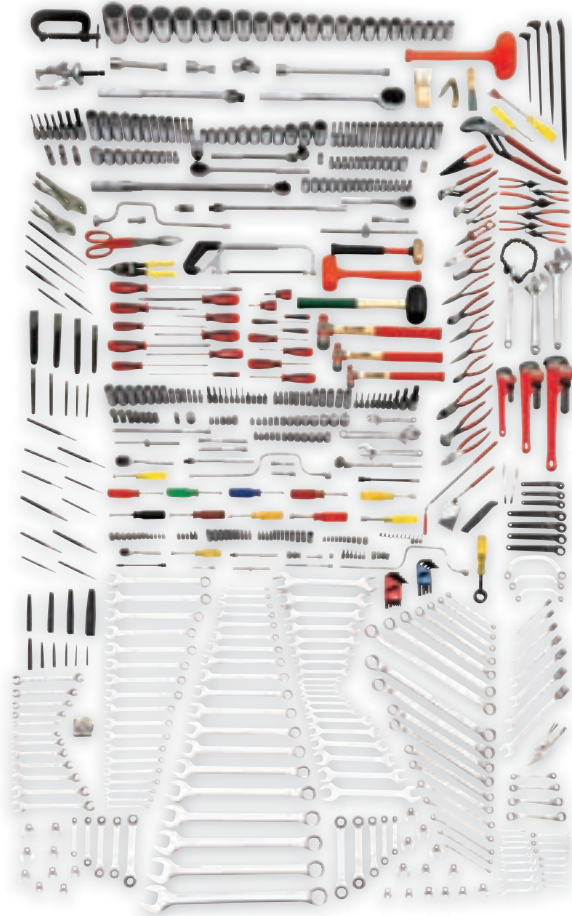

Representative Image; Contents May Differ

| Contents | Description |
|-----------|----------------------------------|
| J4770A | Adapter, Universal Joint 1/4" DR |
| J5270A | Adapter, Universal Joint 3/8" DR |
| J5470A | Adapter, Universal Joint 1/2" DR |
| J5670 | Adapter, Universal Joint 3/4" DR |
| J2126 | Bar, 12" Long 1/2" Tip |
| J2130 | Bar, 16" Long 5/8" Tip |
| J2120 | Bar, Pry Aligning 18" |
| J2124 | Bar, Pry Aligning 24" |
| J404 | C-Clamps, Capacity 0"-4", 2 Each |
| J86A3/16 | Chisel, Cold 1/4" |
| J86A1/4 | Chisel, Cold 5/16" |
| J86A5/16 | Chisel, Cold 3/8" |
| J86A7/16 | Chisel, Cold 1/2" |
| J86A1/2 | Chisel, Cold 5/8" |
| J86A5/8 | Chisel, Cold 3/4" |
| J86A3/4X8 | Chisel, Cold 7/8" |
| J86A7/8X8 | Chisel, Cold 1" |
| J86A1X8 | Chisel, Cold 1-3/16" |
| J4769 | Driver, 1/4" DR |
| J9521 | Extractor, Screw 1/8" |
| J9523 | Extractor, Screw 3/16" |
| J9522 | Extractor, Screw 15/64" |
| J9524 | Extractor, Screw 5/16" |
| J9525 | Extractor, Screw 3/8" |
| J9525B | Extractor, Screw 15/32" |
| J9526 | Extractor, Screw 9/16" |
| J9527 | Extractor, Screw 21/32" |
| J9528 | Extractor, Screw 13/16" |
| J9529 | Extractor, Screw 1-1/16" |
| J4759 | Extension, 1/4" DR 2" |
| J4760 | Extension, 1/4" DR 3" |
| J4761 | Extension, 1/4" DR 6" |
| J5260 | Extension, 3/8" DR 3" |
| J5260-06 | Extension, 3/8" DR 6" |
| J5262 | Extension, 3/8" DR 12" |
| J5460 | Extension, 1/2" DR 2-1/2" |
| J5461 | Extension, 1/2" DR 5" |
| J5463 | Extension, 1/2" DR 10" |
| J5660 | Extension, 3/4" DR 4" |
| J5661 | Extension, 3/4" DR 8" |
| J5663 | Extension, 3/4" DR 16" |
| J4765 | Extension, Flex 1/4" DR 6-1/4" |
| J5268 | Extension, Flex 3/8" DR 8" |
| J5260W | Extension, Wobble 3/8" DR 3" |
| J5260-06W | Extension, Wobble 3/8" DR 6" |
| 15-265 | Hacksaw, 3-7/8" |
| J1430-HB | Hammer Head |
| J1308PD | Hammer, Ball Pein 8 oz. |
| J1316PD | Hammer, Ball Pein 16 oz. |

(CONTINUED ON NEXT PAGE)



613 PC MASTER TECHNICIAN MAINTENANCE SET (CONTINUED)

Product #: JCS-0613MAS



| Contents | Description | Contents | Description |
|----------|---|--------------|--|
| J1332PD | Hammer, Ball Pein 32 oz. | J4205S | Puller, Screw Forcing Acme |
| 57-532 | Hammer, Compo-Cast® 21 oz. | J4022T | Puller, Tip Detachable Standard |
| 57-534 | Hammer, Compo-Cast® 52 oz. | J4255B | Puller, Yoke 3 Way Jaw ACM |
| J4766 | Handle, Hinge 1/4" DR 5-3/4" | J411/2 | Punch, Center 1/2" |
| J5265 | Handle, Hinge 3/8" DR 8-1/2" | J413/8 | Punch, Center 3/8" |
| J5468 | Handle, Hinge 1/2" DR | J963/8 | Punch, Drift 3/16" |
| J5668 | Handle, Hinge 3/4" DR 20" | J965/16 | Punch, Drift 1/8" |
| J4785 | Handle, Sliding T 1/4" DR | J961/2 | Punch, Drift 1/4" |
| J5285 | Handle, Sliding T 3/8" DR | J471/4X3/32 | Punch, Pin 3/32" |
| J5485 | Handle, Sliding T 1/2" DR | J473/8X3/16 | Punch, Pin 3/16" |
| J5685 | Handle, Sliding T 3/4" DR | J475/16X1/8 | Punch, Pin 1/8" |
| J4780G | Handle, Speed 1/4 DR | J475/16X5/32 | Punch, Pin 5/32" |
| J5280G | Handle, Speed 3/8 DR | J477/16X7/32 | Punch, Pin 7/32" |
| J5480G | Handle, Speed 1/2 DR | J471/2X1/4 | Punch, Pin 1/4" |
| J4984 | Hex Key, 9 PC Metric Set | J445/16 | Punch, Prick 5/16" |
| J4980 | Hex Key, 13 PC Standard Set | J501/4 | Punch, Starting 3/32" |
| J2108 | Holder, Punch and Chisel | J503/8 | Punch, Starting 3/16" |
| J95218 | Knife, Folding Blade | J505/16 | Punch, Starting 1/8" |
| J18545B | Knife, Lockback 5" | J507/16 | Punch, Starting 7/32" |
| 10-099 | Knife, Stanley® Classic 99® Retractable Blade Utility | J501/2 | Punch, Starting 1/4" |
| J1368 | Mallet, Rubber | J4749 | Ratchet, 1/4" DR |
| J2373 | Mirror, Rectangular Telescoping 2-1/8" | J5249 | Ratchet, 3/8" DR |
| J9206 | Nut Driver, 3/16" | J5449 | Ratchet, 1/2" DR |
| J9207 | Nut Driver, 7/32" | J5450 | Ratchet, 1/2" DR (Long Handle) |
| J9208 | Nut Driver, 1/4" | J5649 | Ratchet, 3/4" DR |
| J9210 | Nut Driver, 5/16" | J5247 | Ratchet Adapter 3/8" DR 2-1/16" |
| J9211 | Nut Driver, 11/32" | J5447 | Ratchet Adapter 1/2" DR 2-21/32" |
| J9212 | Nut Driver, 3/8" | J5257F | Ratchet, 3/8" DR Flex-Head 2-1/16" |
| J9214 | Nut Driver 7/16" | J5457F | Ratchet, 1/2" DR Flex-Head 17-3/32" |
| J9216 | Nut Driver, 1/2" | J2375 | Retrieval Tool, Pocket Magnetic |
| J9218 | Nut Driver, 9/16" | 28-240 | Scraper, Flexible Nylon 1-1/4" |
| J9220 | Nut Driver, 5/8" | J2336 | Scrapers, Gasket and Carbon |
| J9209 | Nut Driver, 9/32" | J9884 | Screw Starter, Phillips® Tip |
| J206G | Pliers, Diagonal Cutting with Grip 6-1/16" | J9853 | Screw Starter, Standard Tip |
| J209G | Pliers, Diagonal Cutting with Grip 7-5/16" | J88203 | Screwdriver, Slotted Cabinet, Round 1/8" x 3" |
| J227G | Pliers, Duckbill with Grip 7-25/32" | J88204 | Screwdriver, Slotted Cabinet, Round 1/8" x 4" |
| J272G | Pliers, End Cutting High Leverage 8-1/4" | J88208 | Screwdriver, Slotted Cabinet, Round 1/8" x 8" |
| J268G | Pliers, Lineman's with Grip 8-5/8" | J88214 | Screwdriver, Slotted Cabinet, Round 3/16" x 4" |
| J292NC | Pliers, Locking Curved 10" | J88218 | Screwdriver, Slotted Cabinet, Round 3/16" x 8" |
| J286LNXL | Pliers, Locking Mini Long Nose 6-29/32" | J88393 | Screwdriver, Phillips® #0 |
| J291NC | Pliers, Locking Straight 7" | J88313 | Screwdriver, Phillips® #1 |
| J225G | Pliers, Needle-Nose Bent Nose 6-5/16" | J88318 | Screwdriver, Phillips® #1 |
| J222G | Pliers, Needle-Nose Long Thin 6-1/16" | J88322 | Screwdriver, Phillips® #2 |
| J226G | Pliers, Needle-Nose with Cutter 6-5/8" | J88324 | Screwdriver, Phillips® #2 |
| J360A | Pliers, 6 PC Retaining Ring Set | J88328 | Screwdriver, Phillips® #2 |
| J276G | Pliers, Slip-Joint with Grip 6-9/16" | J88336 | Screwdriver, Phillips® #3 |
| J278G | Pliers, Slip-Joint with Grip 8-1/16" | J88348 | Screwdriver, Phillips® #4 |
| J261SG | Pliers, Tongue and Groove 5" with Grip | J88102 | Screwdriver, Slotted Keystone, Square 1/4" x 2" |
| J262SG | Pliers, Tongue and Groove 6-1/2" with Grip | J88104 | Screwdriver, Slotted Keystone, Square 1/4" x 4" |
| J260SG | Pliers, Tongue and Groove 10-3/16" with Grip | J88106 | Screwdriver, Slotted Keystone, Square 1/4" x 6" |
| J265SG | Pliers, Tongue and Groove 16" with Grip | J88108 | Screwdriver, Slotted Keystone, Square 1/4" x 8" |
| J298 | Pliers, Wire Strippers 8-1/4" | J88112 | Screwdriver, Slotted Keystone, Square 1/4" x 12" |
| J2306 | Puller, Cotter Pin Tool | J88002 | Screwdriver, Slotted Keystone, Round 1/4" x 1-1/2" |
| J4056-4 | Puller, Jaw Reversible 4 R | J322 | Snips, Straight 12-3/4" |
| J4250N | Puller, Nut Adjustable Reversible | J303S | Snips, Aviation Straight |
| J4056PN | Puller, Pin Pivot | J308 | Snips, Miniature |





| Contents | Description |
|-----------------|----------------------------------|
| J4706 | Socket, 1/4" DR 3/16" 6 PT |
| J4708 | Socket, 1/4" DR 1/4" 6 PT |
| J4709 | Socket, 1/4" DR 9/32" 6 PT |
| J4710 | Socket, 1/4" DR 5/16" 6 PT |
| J4711 | Socket, 1/4" DR 11/32" 6 PT |
| J4712 | Socket, 1/4" DR 3/8" 6 PT |
| J4714 | Socket, 1/4" DR 7/16" 6 PT |
| J4707 | Socket, 1/4" DR 7/32" 6 PT |
| J4716 | Socket, 1/4" DR 1/2" 6 PT |
| J4718 | Socket, 1/4" DR 9/16" 6 PT |
| J4704M | Socket, 1/4" DR 4 mm 6 PT |
| J4705M | Socket, 1/4" DR 5 mm 6 PT |
| J47055M | Socket, 1/4" DR 5.5 mm 6 PT |
| J4706M | Socket, 1/4" DR 6 mm 6 PT |
| J4707M | Socket, 1/4" DR 7 mm 6 PT |
| J4708M | Socket, 1/4" DR 8 mm 6 PT |
| J4709M | Socket, 1/4" DR 9 mm 6 PT |
| J4710M | Socket, 1/4" DR 10 mm 6 PT |
| J4711M | Socket, 1/4" DR 11 mm 6 PT |
| J4712M | Socket, 1/4" DR 12 mm 6 PT |
| J4713M | Socket, 1/4" DR 13 mm 6 PT |
| J4714M | Socket, 1/4" DR 14 mm 6 PT |
| J4706L | Socket, 1/4" DR 3/16" 6 PT Deep |
| J4707L | Socket, 1/4" DR 7/32" 6 PT Deep |
| J4708L | Socket, 1/4" DR 1/4" 6 PT Deep |
| J4709L | Socket, 1/4" DR 9/32" 6 PT Deep |
| J4710L | Socket, 1/4" DR 5/16" 6 PT Deep |
| J4711L | Socket, 1/4" DR 11/32" 6 PT Deep |
| J4712L | Socket, 1/4" DR 3/8" 6 PT Deep |
| J4714L | Socket, 1/4" DR 7/16" 6 PT Deep |
| J4716L | Socket, 1/4" DR 1/2" 6 PT Deep |
| J4718L | Socket, 1/4" DR 9/16" 6 PT Deep |
| J4704LM | Socket, 1/4" DR 4 mm 6 PT Deep |
| J4705LM | Socket, 1/4" DR 5 mm 6 PT Deep |
| J47055LM | Socket, 1/4" DR 5.5 mm 6 PT Deep |
| J4706LM | Socket, 1/4" DR 6 mm 6 PT Deep |
| J4707LM | Socket, 1/4" DR 7 mm 6 PT Deep |
| J4708LM | Socket, 1/4" DR 8 mm 6 PT Deep |
| J4709LM | Socket, 1/4" DR 9 mm 6 PT Deep |
| J4710LM | Socket, 1/4" DR 10 mm 6 PT Deep |
| J4711LM | Socket, 1/4" DR 11 mm 6 PT Deep |
| J4712LM | Socket, 1/4" DR 12 mm 6 PT Deep |
| J4713LM | Socket, 1/4" DR 13 mm 6 PT Deep |
| J4714LM | Socket, 1/4" DR 14 mm 6 PT Deep |
| J4708S | Socket, 1/4" DR 1/4" 8 PT |
| J4712S | Socket, 1/4" DR 3/8" 8 PT |
| J4710S | Socket, 1/4" DR 5/16" 8 PT |
| J5208S | Socket, 3/8" DR 1/4" 8 PT |
| J5210S | Socket, 3/8" DR 5/16" 8 PT |
| J5212S | Socket, 3/8" DR 3/8" 8 PT |
| J5214S | Socket, 3/8" DR 7/16" 8 PT |
| J5216S | Socket, 3/8" DR 1/2" 8 PT |
| J5232 | Socket, 3/8" DR 1" 12 PT |
| J5216 | Socket, 3/8" DR 1/2" 12 PT |
| J5208 | Socket, 3/8" DR 1/4" 12 PT |
| J5222 | Socket, 3/8" DR 11/16" 12 PT |
| J5226 | Socket, 3/8" DR 13/16" 12 PT |
| J5230 | Socket, 3/8" DR 15/16" 12 PT |

| Contents | Description |
|-----------------|-----------------------------------|
| J5224 | Socket, 3/8" DR 3/4" 12 PT |
| J5212 | Socket, 3/8" DR 3/8" 12 PT |
| J5210 | Socket, 3/8" DR 5/16" 12 PT |
| J5220 | Socket, 3/8" DR 5/8" 12 PT |
| J5214 | Socket, 3/8" DR 7/16" 12 PT |
| J5218 | Socket, 3/8" DR 9/16" 12 PT |
| J5228 | Socket, 3/8" DR 7/8" 12 PT |
| J5208M | Socket, 3/8" DR 8 mm 12 PT |
| J5209M | Socket, 3/8" DR 9 mm 12 PT |
| J5210M | Socket, 3/8" DR 10 mm 12 PT |
| J5211M | Socket, 3/8" DR 11 mm 12 PT |
| J5212M | Socket, 3/8" DR 12 mm 12 PT |
| J5213M | Socket, 3/8" DR 13 mm 12 PT |
| J5214M | Socket, 3/8" DR 14 mm 12 PT |
| J5215M | Socket, 3/8" DR 15 mm 12 PT |
| J5216M | Socket, 3/8" DR 16 mm 12 PT |
| J5217M | Socket, 3/8" DR 17 mm 12 PT |
| J5218M | Socket, 3/8" DR 18 mm 12 PT |
| J5219M | Socket, 3/8" DR 19 mm 12 PT |
| J5008 | Socket, 3/8" DR 1/4" 12 PT Deep |
| J5010 | Socket, 3/8" DR 5/16" 12 PT Deep |
| J5012 | Socket, 3/8" DR 3/8" 12 PT Deep |
| J5014 | Socket, 3/8" DR 7/16" 12 PT Deep |
| J5016 | Socket, 3/8" DR 1/2" 12 PT Deep |
| J5018 | Socket, 3/8" DR 9/16" 12 PT Deep |
| J5020 | Socket, 3/8" DR 5/8" 12 PT Deep |
| J5022 | Socket, 3/8" DR 11/16" 12 PT Deep |
| J5024 | Socket, 3/8" DR 3/4" 12 PT Deep |
| J5026 | Socket, 3/8" DR 13/16" 12 PT Deep |
| J5028 | Socket, 3/8" DR 7/8" 12 PT Deep |
| J5030 | Socket, 3/8" DR 15/16" 12 PT Deep |
| J5032 | Socket, 3/8" DR 1" 12 PT Deep |
| J5008M | Socket, 3/8" DR 8 mm 12 PT Deep |
| J5009M | Socket, 3/8" DR 9 mm 12 PT Deep |
| J5010M | Socket, 3/8" DR 10 mm 12 PT Deep |
| J5011M | Socket, 3/8" DR 11 mm 12 PT Deep |
| J5012M | Socket, 3/8" DR 12 mm 12 PT Deep |
| J5013M | Socket, 3/8" DR 13 mm 12 PT Deep |
| J5014M | Socket, 3/8" DR 14 mm 12 PT Deep |
| J5015M | Socket, 3/8" DR 15 mm 12 PT Deep |
| J5016M | Socket, 3/8" DR 16 mm 12 PT Deep |
| J5017M | Socket, 3/8" DR 17 mm 12 PT Deep |
| J5018M | Socket, 3/8" DR 18 mm 12 PT Deep |
| J5019M | Socket, 3/8" DR 19 mm 12 PT Deep |
| J5412S | Socket, 1/2" DR 3/8" 8 PT |
| J5414S | Socket, 1/2" DR 7/16" 8 PT |
| J5416S | Socket, 1/2" DR 1/2" 8 PT |
| J5418S | Socket, 1/2" DR 9/16" 8 PT |
| J5420S | Socket, 1/2" DR 5/8" 8 PT |
| J5422S | Socket, 1/2" DR 11/16" 8 PT |
| J5424S | Socket, 1/2" DR 3/4" 8 PT |
| J5426S | Socket, 1/2" DR 13/16" 8 PT |
| J5428S | Socket, 1/2" DR 7/8" 8 PT |
| J5432S | Socket, 1/2" DR 1" 8 PT |
| J5414 | Socket, 1/2" DR 7/16" 12 PT |
| J5412 | Socket, 1/2" DR 3/8" 12 PT |
| J5416 | Socket, 1/2" DR 1/2" 12 PT |
| J5418 | Socket, 1/2" DR 9/16" 12 PT |

(CONTINUED ON NEXT PAGE)

613 PC MASTER TECHNICIAN MAINTENANCE SET (CONTINUED)

Product #: **JCS-0613MAS**



| Contents | Description | Contents | Description |
|----------|------------------------------------|------------|---|
| J5419 | Socket, 1/2" DR 19/32" 12 PT | J5321M | Socket, 1/2" DR 21 mm 12 PT Deep |
| J5420 | Socket, 1/2" DR 5/8" 12 PT | J5322M | Socket, 1/2" DR 22 mm 12 PT Deep |
| J5422 | Socket, 1/2" DR 11/16" 12 PT | J5323M | Socket, 1/2" DR 23 mm 12 PT Deep |
| J5424 | Socket, 1/2" DR 3/4" 12 PT | J5324M | Socket, 1/2" DR 24 mm 12 PT Deep |
| J5425 | Socket, 1/2" DR 25/32" 12 PT | J5444A | Socket, 1/2" DR Drag Link 3/4" |
| J5426 | Socket, 1/2" DR 13/16" 12 PT | J5446A | Socket, 1/2" DR Drag Link 15/16" |
| J5428 | Socket, 1/2" DR 7/8" 12 PT | J5528 | Socket, 3/4" DR 7/8" 12 PT |
| J5429 | Socket, 1/2" DR 29/32" 12 PT | J5530 | Socket, 3/4" DR 15/16" 12 PT |
| J5430 | Socket, 1/2" DR 15/16" 12 PT | J5532 | Socket, 3/4" DR 1" 12 PT |
| J5432 | Socket, 1/2" DR 1" 12 PT | J5534 | Socket, 3/4" DR 1-1/16" 12 PT |
| J5434 | Socket, 1/2" DR 1-1/16" 12 PT | J5536 | Socket, 3/4" DR 1-1/8" 12 PT |
| J5436 | Socket, 1/2" DR 1-1/8" 12 PT | J5540 | Socket, 3/4" DR 1-1/4" 12 PT |
| J5438 | Socket, 1/2" DR 1-3/16" 12 PT | J5548 | Socket, 3/4" DR 1-1/2" 12 PT |
| J5440 | Socket, 1/2" DR 1-1/4" 12 PT | J5554 | Socket, 3/4" DR 1-11/16" 12 PT |
| J5442 | Socket, 1/2" DR 1-5/16" 12 PT | J5558 | Socket, 3/4" DR 1-13/16" 12 PT |
| J5444 | Socket, 1/2" DR 1-3/8" 12 PT | J5538 | Socket, 3/4" DR 1-3/16" 12 PT |
| J5446 | Socket, 1/2" DR 1-7/16" 12 PT | J5556 | Socket, 3/4" DR 1-3/4" 12 PT |
| J5448 | Socket, 1/2" DR 1-1/2" 12 PT | J5544 | Socket, 3/4" DR 1-3/8" 12 PT |
| J5410M | Socket, 1/2" DR 10 mm 12 PT | J5542 | Socket, 3/4" DR 1-5/16" 12 PT |
| J5411M | Socket, 1/2" DR 11 mm 12 PT | J5552 | Socket, 3/4" DR 1-5/8" 12 PT |
| J5412M | Socket, 1/2" DR 12 mm 12 PT | J5546 | Socket, 3/4" DR 1-7/16" 12 PT |
| J5413M | Socket, 1/2" DR 13 mm 12 PT | J5560 | Socket, 3/4" DR 1-7/8" 12 PT |
| J5414M | Socket, 1/2" DR 14 mm 12 PT | J5550 | Socket, 3/4" DR 1-9/16" 12 PT |
| J5415M | Socket, 1/2" DR 15 mm 12 PT | J5564 | Socket, 3/4" DR 2" 12 PT |
| J5416M | Socket, 1/2" DR 16 mm 12 PT | J5572 | Socket, 3/4" DR 2-1/4" 12 PT |
| J5417M | Socket, 1/2" DR 17 mm 12 PT | J5568 | Socket, 3/4" DR 2-1/8" 12 PT |
| J5418M | Socket, 1/2" DR 18 mm 12 PT | J5570 | Socket, 3/4" DR 2-3/16" 12 PT |
| J5419M | Socket, 1/2" DR 19 mm 12 PT | J5576 | Socket, 3/4" DR 2-3/8" 12 PT |
| J5420M | Socket, 1/2" DR 20 mm 12 PT | J4737 | Socket, Bit 1/4" DR #1 Phillips® |
| J5421M | Socket, 1/2" DR 21 mm 12 PT | J4738 | Socket, Bit 1/4" DR #2 Phillips® |
| J5422M | Socket, 1/2" DR 22 mm 12 PT | J5241 | Socket, Bit 3/8" DR #2 Phillips® |
| J5423M | Socket, 1/2" DR 23 mm 12 PT | J5242 | Socket, Bit 3/8" DR #3 Phillips® |
| J5424M | Socket, 1/2" DR 24 mm 12 PT | J5243 | Socket, Bit 3/8" DR #4 Phillips® |
| J5316 | Socket, 1/2" DR 1/2" 12 PT Deep | J4743 | Socket, Bit 1/4" DR Slotted 1/4" 1-3/16" |
| J5322 | Socket, 1/2" DR 11/16" 12 PT Deep | J4744 | Socket, Bit 1/4" DR Slotted 3/16" |
| J5320 | Socket, 1/2" DR 5/8" 12 PT Deep | J4745 | Socket, Bit 1/4" DR Slotted 1/4" 1-13/64" |
| J5318 | Socket, 1/2" DR 9/16" 12 PT Deep | J5246 | Socket, Bit 3/8" DR Slotted |
| J5324 | Socket, 1/2" DR 3/4" 12 PT Deep | J47701/16 | Socket, Hex Bit 1/4" DR 1/16" |
| J5326 | Socket, 1/2" DR 13/16" 12 PT Deep | J47705/64 | Socket, Hex Bit 1/4" DR 5/64" |
| J5328 | Socket, 1/2" DR 7/8" 12 PT Deep | J47703/32 | Socket, Hex Bit 1/4" DR 3/32" |
| J5330 | Socket, 1/2" DR 15/16" 12 PT Deep | J47707/64 | Socket, Hex Bit 1/4" DR 7/64" |
| J5332 | Socket, 1/2" DR 1" 12 PT Deep | J47701/8 | Socket, Hex Bit 1/4" DR 1/8" |
| J5334 | Socket, 1/2" DR 1-1/16" 12 PT Deep | J47709/64 | Socket, Hex Bit 1/4" DR 9/64" |
| J5336 | Socket, 1/2" DR 1-1/8" 12 PT Deep | J47705/32 | Socket, Hex Bit 1/4" DR 5/32" |
| J5340 | Socket, 1/2" DR 1-1/4" 12 PT Deep | J47703/16 | Socket, Hex Bit 1/4" DR 3/16" |
| J5310M | Socket, 1/2" DR 10 mm 12 PT Deep | J47707/32 | Socket, Hex Bit 1/4" DR 7/32" |
| J5311M | Socket, 1/2" DR 11 mm 12 PT Deep | J47701/4 | Socket, Hex Bit 1/4" DR 1/4" |
| J5312M | Socket, 1/2" DR 12 mm 12 PT Deep | J47705/16 | Socket, Hex Bit 1/4" DR 5/16" |
| J5313M | Socket, 1/2" DR 13 mm 12 PT Deep | J4770-2M | Socket, Hex Bit 1/4" DR 2 mm |
| J5314M | Socket, 1/2" DR 14 mm 12 PT Deep | J4770-2.5M | Socket, Hex Bit 1/4" DR 2.5 mm |
| J5315M | Socket, 1/2" DR 15 mm 12 PT Deep | J4770-3M | Socket, Hex Bit 1/4" DR 3 mm |
| J5316M | Socket, 1/2" DR 16 mm 12 PT Deep | J4770-4M | Socket, Hex Bit 1/4" DR 4 mm |
| J5317M | Socket, 1/2" DR 17 mm 12 PT Deep | J4770-5M | Socket, Hex Bit 1/4" DR 5 mm |
| J5318M | Socket, 1/2" DR 18 mm 12 PT Deep | J4770-6M | Socket, Hex Bit 1/4" DR 6 mm |
| J5319M | Socket, 1/2" DR 19 mm 12 PT Deep | J49901/8 | Socket, Hex Bit 3/8" DR 1/8" |
| J5320M | Socket, 1/2" DR 20 mm 12 PT Deep | J49901/4 | Socket, Hex Bit 3/8" DR 1/4" |





| Contents | Description |
|-----------|---|
| J49903/8 | Socket, Hex Bit 3/8" DR 3/8" |
| J49905/32 | Socket, Hex Bit 3/8" DR 5/32" |
| J49903/16 | Socket, Hex Bit 3/8" DR 3/16" |
| J49907/32 | Socket, Hex Bit 3/8" DR 7/32" |
| J49905/16 | Socket, Hex Bit 3/8" DR 5/16" |
| J4990-4M | Socket, Hex Bit 3/8" DR 4 mm |
| J4990-5M | Socket, Hex Bit 3/8" DR 5 mm |
| J4990-6M | Socket, Hex Bit 3/8" DR 6 mm |
| J4990-7M | Socket, Hex Bit 3/8" DR 7 mm |
| J4990-8M | Socket, Hex Bit 3/8" DR 8 mm |
| J4990-9M | Socket, Hex Bit 3/8" DR 9 mm |
| J4990-10M | Socket, Hex Bit 3/8" DR 10 mm |
| J54411/4 | Socket, Hex Bit 1/2" DR 1/4" |
| J54415/16 | Socket, Hex Bit 1/2" DR 5/16" |
| J54413/8 | Socket, Hex Bit 1/2" DR 3/8" |
| J54417/16 | Socket, Hex Bit 1/2" DR 7/16" |
| J54411/2 | Socket, Hex Bit 1/2" DR 1/2" |
| J54419/16 | Socket, Hex Bit 1/2" DR 9/16" |
| J54415/8 | Socket, Hex Bit 1/2" DR 5/8" |
| J5441-12M | Socket, Hex Bit 1/2" DR 12 mm |
| J5441-14M | Socket, Hex Bit 1/2" DR 14 mm |
| J5441-17M | Socket, Hex Bit 1/2" DR 17 mm |
| J4771TA | Socket, Universal 1/4" DR 1/4" 12 PT |
| J4772TA | Socket, Universal 1/4" DR 5/16" 12 PT |
| J4773TA | Socket, Universal 1/4" DR 3/8" 12 PT |
| J4774TA | Socket, Universal 1/4" DR 7/16" 12 PT |
| J5273A | Socket, Universal 3/8" DR 3/8" 12 PT |
| J5274A | Socket, Universal 3/8" DR 7/16" 12 PT |
| J5275A | Socket, Universal 3/8" DR 1/2" 12 PT |
| J5276A | Socket, Universal 3/8" DR 9/16" 12 PT |
| J5277A | Socket, Universal 3/8" DR 5/8" 12 PT |
| J5278A | Socket, Universal 3/8" DR 11/16" 12 PT |
| J5279A | Socket, Universal 3/8" DR 3/4" 12 PT |
| J5475A | Socket, Universal 1/2" DR 1/2" 12 PT |
| J5476A | Socket, Universal 1/2" DR 9/16" 12 PT |
| J5477A | Socket, Universal 1/2" DR 5/8" 12 PT |
| 33-212 | Tape Rule, Stanley® Powerlock® with Metal Case 1/2" x 12' |
| J710 | Wrench, Adjustable 10" |
| J712 | Wrench, Adjustable 12" |
| J715 | Wrench, Adjustable 15" |
| J706 | Wrench, Adjustable 6" |
| J708 | Wrench, Adjustable 8" |
| J3332 | Wrench, Angle 1/2" |
| J3316 | Wrench, Angle 1/4" |
| J3322 | Wrench, Angle 11/32" |
| J3315 | Wrench, Angle 15/64" |
| J3324 | Wrench, Angle 3/8" |
| J3320 | Wrench, Angle 5/16" |
| J3328 | Wrench, Angle 7/16" |
| J3314 | Wrench, Angle 7/32" |
| J3318 | Wrench, Angle 9/32" |
| J1170 | Wrench, Box 5/16" x 3/8" 12 PT |
| J1171 | Wrench, Box 7/16" x 1/2" 12 PT |
| J1173 | Wrench, Box 11/16" x 3/4" 12 PT |
| J1174 | Wrench, Box 13/16" x 7/8" 12 PT |
| J1175 | Wrench, Box 15/16" x 1" 12 PT |
| J1176 | Wrench, Box 1-1/16" x 1-1/8" 12 PT |
| J1050M | Wrench, Box 6 x 7 mm 12 PT |

| Contents | Description |
|-----------|---------------------------------------|
| J1051M | Wrench, Box 8 x 9 mm 12 PT |
| J1053M | Wrench, Box 10 x 11 mm 12 PT |
| J1057M | Wrench, Box 12 x 13 mm 12 PT |
| J1061M | Wrench, Box 14 x 15 mm 12 PT |
| J1064M | Wrench, Box 16 x 18 mm 12 PT |
| J1065M | Wrench, Box 17 x 19 mm 12 PT |
| J1072M | Wrench, Box 21 x 24 mm 12 PT |
| J1073M | Wrench, Box 22 x 24 mm 12 PT |
| J1077M | Wrench, Box 27 x 30 mm 12 PT |
| J1079M | Wrench, Box 30 x 32 mm 12 PT |
| J1172 | Wrench, Box 9/16" x 5/8" 12 PT |
| J1120 | Wrench, Box 5/16" x 3/8" 12 PT Short |
| J1122 | Wrench, Box 3/8" x 7/16" 12 PT Short |
| J1126 | Wrench, Box 1/2" x 9/16" 12 PT Short |
| J1131 | Wrench, Box 5/8" x 3/4" 12 PT Short |
| J801 | Wrench, Chain |
| J1210A | Wrench, Combination 5/16" 12 PT |
| J1212ASD | Wrench, Combination 3/8" 12 PT |
| J1214ASD | Wrench, Combination 7/16" 12 PT |
| J1216ASD | Wrench, Combination 1/2" 12 PT |
| J1218ASD | Wrench, Combination 9/16" 12 PT |
| J1220ASD | Wrench, Combination 5/8" 12 PT |
| J1222ASD | Wrench, Combination 11/16" 12 PT |
| J1224ASD | Wrench, Combination 3/4" 12 PT |
| J1226ASD | Wrench, Combination 13/16" 12 PT |
| J1228ASD | Wrench, Combination 7/8" 12 PT |
| J1230ASD | Wrench, Combination 15/16" 12 PT |
| J1232ASD | Wrench, Combination 1" 12 PT |
| J1234ASD | Wrench, Combination 1-1/16" 12 PT |
| J1248 | Wrench, Combination 1-1/2" 12 PT |
| J1240ASD | Wrench, Combination 1-1/4" 12 PT |
| J1236ASD | Wrench, Combination 1-1/8" 12 PT |
| J1244 | Wrench, Combination 1-3/8" 12 PT |
| J1242 | Wrench, Combination 1-5/16" 12 PT |
| J1246 | Wrench, Combination 1-7/16" 12 PT |
| J1207MA | Wrench, Combination 7 mm 12 PT |
| J1208MA | Wrench, Combination 8 mm 12 PT |
| J1209MA | Wrench, Combination 9 mm 12 PT |
| J1210MASD | Wrench, Combination 10 mm 12 PT |
| J1211MASD | Wrench, Combination 11 mm 12 PT |
| J1212MASD | Wrench, Combination 12 mm 12 PT |
| J1213MASD | Wrench, Combination 13 mm 12 PT |
| J1214MASD | Wrench, Combination 14 mm 12 PT |
| J1215MASD | Wrench, Combination 15 mm 12 PT |
| J1216MASD | Wrench, Combination 16 mm 12 PT |
| J1217MASD | Wrench, Combination 17 mm 12 PT |
| J1218MASD | Wrench, Combination 18 mm 12 PT |
| J1219MASD | Wrench, Combination 19 mm 12 PT |
| J1220MASD | Wrench, Combination 20 mm 12 PT |
| J1221MASD | Wrench, Combination 21 mm 12 PT |
| J1222MASD | Wrench, Combination 22 mm 12 PT |
| J1223MASD | Wrench, Combination 23 mm 12 PT |
| J1224MASD | Wrench, Combination 24 mm 12 PT |
| J1204EF | Wrench, Combination 1/8" 6 PT Short |
| J1205EF | Wrench, Combination 5/32" 6 PT Short |
| J1206EF | Wrench, Combination 3/16" 6 PT Short |
| J1208EF | Wrench, Combination 1/4" 6 PT Short |
| J1211EF | Wrench, Combination 11/32" 6 PT Short |

(CONTINUED ON NEXT PAGE)

613 PC MASTER TECHNICIAN MAINTENANCE SET (CONTINUED)

Product #: JCS-0613MAS



| Contents | Description | Contents | Description |
|----------|---|-----------|--|
| J1210EF | Wrench, Combination 5/16" 6 PT Short | J3824 | Wrench, Flare Nut Ratcheting 3/4" |
| J1212EF | Wrench, Combination 3/8" 6 PT Short | J1731 | Wrench, Obstruction 5/8" x 3/4" |
| J1209EF | Wrench, Combination 9/32" 6 PT Short | J1725 | Wrench, Obstruction 7/16" x 1/2" |
| J4912CF | Wrench, Crowfoot 3/8" DR 3/8" Open End | J1730 | Wrench, Obstruction 9/16" x 5/8" |
| J4914CF | Wrench, Crowfoot 3/8" DR 7/16" Open End | J3018 | Wrench, Open End 1/4" x 5/16" |
| J4916CF | Wrench, Crowfoot 3/8" DR 1/2" Open End | J3020 | Wrench, Open End 3/8" x 5/16" |
| J4918CF | Wrench, Crowfoot 3/8" DR 9/16" Open End | J3025 | Wrench, Open End 7/16" x 1/2" |
| J4920CF | Wrench, Crowfoot 3/8" DR 5/8" Open End | J3026 | Wrench, Open End 1/2" x 9/16" |
| J4922CF | Wrench, Crowfoot 3/8" DR 11/16" Open End | J3030 | Wrench, Open End 9/16" x 5/8" |
| J4924CF | Wrench, Crowfoot 3/8" DR 3/4" Open End | J3031 | Wrench, Open End 5/8" x 3/4" |
| J4926CF | Wrench, Crowfoot 3/8" DR 13/16" Open End | J3035 | Wrench, Open End 11/16" x 3/4" |
| J4928CF | Wrench, Crowfoot 3/8" DR 7/8" Open End | J3040 | Wrench, Open End 13/16" x 7/8" |
| J4909MCF | Wrench, Crowfoot 3/8" DR 9 mm Open End | J3045 | Wrench, Open End 15/16" x 1" |
| J4910MCF | Wrench, Crowfoot 3/8" DR 10 mm Open End | J3050 | Wrench, Open End 1-1/16" x 1-1/8" |
| J4911MCF | Wrench, Crowfoot 3/8" DR 11 mm Open End | J30607 | Wrench, Open End 6 mm x 7 mm |
| J4912MCF | Wrench, Crowfoot 3/8" DR 12 mm Open End | J30809 | Wrench, Open End 8 mm x 9 mm |
| J4913MCF | Wrench, Crowfoot 3/8" DR 13 mm Open End | J31011 | Wrench, Open End 10 mm x 11 mm |
| J4914MCF | Wrench, Crowfoot 3/8" DR 14 mm Open End | J31213 | Wrench, Open End 12 mm x 13 mm |
| J4915MCF | Wrench, Crowfoot 3/8" DR 15 mm Open End | J31415 | Wrench, Open End 14 mm x 15 mm |
| J4916MCF | Wrench, Crowfoot 3/8" DR 16 mm Open End | J31617 | Wrench, Open End 16 mm x 17 mm |
| J4917MCF | Wrench, Crowfoot 3/8" DR 17 mm Open End | J31819 | Wrench, Open End 18 mm x 19 mm |
| J4918MCF | Wrench, Crowfoot 3/8" DR 18 mm Open End | J32022 | Wrench, Open End 20 mm x 22 mm |
| J4919MCF | Wrench, Crowfoot 3/8" DR 19 mm Open End | J32123 | Wrench, Open End 21 mm x 23 mm |
| J4920MCF | Wrench, Crowfoot 3/8" DR 20 mm Open End | J32426 | Wrench, Open End 24 mm x 26 mm |
| J4921MCF | Wrench, Crowfoot 3/8" DR 21 mm Open End | J810HD | Wrench, Pipe Heavy-Duty 10" |
| J4922MCF | Wrench, Crowfoot 3/8" DR 22 mm Open End | J814HD | Wrench, Pipe Heavy-Duty 14" |
| J4923MCF | Wrench, Crowfoot 3/8" DR 23 mm Open End | J818HD | Wrench, Pipe Heavy-Duty 18" |
| J4924MCF | Wrench, Crowfoot 3/8" DR 24 mm Open End | J1191T-A | Wrench, Ratcheting Box 1/4" x 5/16" 12 PT |
| J3707M | Wrench, Flare Nut 7 mm x 8 mm | J1192T-A | Wrench, Ratcheting Box 3/8" x 7/16" 12 PT |
| J3709M | Wrench, Flare Nut 9 mm x 11 mm | J1193T-A | Wrench, Ratcheting Box 1/2" x 9/16" 12 PT |
| J3710M | Wrench, Flare Nut 10 mm x 12 mm | J1194-A | Wrench, Ratcheting Box 5/8" x 11/16" 12 PT |
| J3713M | Wrench, Flare Nut 13 mm x 14 mm | J1195-A | Wrench, Ratcheting Box 3/4" x 7/8" 12 PT |
| J3715M | Wrench, Flare Nut 15 mm x 17 mm | J1191M-A | Wrench, Ratcheting Box 7 mm x 8 mm |
| J3751 | Wrench, Flare Nut Combination 3/8" 6 PT | J1192M-A | Wrench, Ratcheting Box 9 mm x 10 mm |
| J3752 | Wrench, Flare Nut Combination 7/16" 6 PT | J1193MA-A | Wrench, Ratcheting Box 11 mm x 12 mm |
| J3753 | Wrench, Flare Nut Combination 1/2" 6 PT | J1194MA-A | Wrench, Ratcheting Box 13 mm x 14 mm |
| J3754 | Wrench, Flare Nut Combination 9/16" 6 PT | J1195M-A | Wrench, Ratcheting Box 15 mm x 17 mm |
| J3755 | Wrench, Flare Nut Combination 5/8" 6 PT | J1270-12 | Wrench, Swivel Combination 3/8" 12 PT |
| J3756 | Wrench, Flare Nut Combination 11/16" 6 PT | J1270-14 | Wrench, Swivel Combination 7/16" 12 PT |
| J3757 | Wrench, Flare Nut Combination 3/4" 6 PT | J1270-16 | Wrench, Swivel Combination 1/2" 12 PT |
| J3812 | Wrench, Flare Nut Ratcheting 3/8" | J1270-18 | Wrench, Swivel Combination 9/16" 12 PT |
| J3814 | Wrench, Flare Nut Ratcheting 7/16" | J1270-20 | Wrench, Swivel Combination 5/8" 12 PT |
| J3816 | Wrench, Flare Nut Ratcheting 1/2" | J1270-22 | Wrench, Swivel Combination 11/16" 12 PT |
| J3818 | Wrench, Flare Nut Ratcheting 9/16" | J1270-24 | Wrench, Swivel Combination 3/4" 12 PT |
| J3820 | Wrench, Flare Nut Ratcheting 5/8" | J6014C | Wrench, Torque 1/2" DR 50-250 ft-lbs |
| J3822 | Wrench, Flare Nut Ratcheting 11/16" | | |



613 PC MASTER TECHNICIAN MAINTENANCE SET WITH WORKSTATION J455041-10RD

Product #: JCS-0613MASBX1

- › 613 pieces.
- › 1/4", 3/8", 1/2", 3/4" Drive Tools.
- › Designed for fastener sizes 1/16" - 2-3/8", 2 mm - 24 mm.
- › Contains: 305 Sockets and Accessories, 167 Wrenches, 33 Striking and Struck Tools, 22 Pliers, 32 Screwdrivers, 54 Miscellaneous Tools.
- › Modules contained: JCS-MAS-1, JCS-MAS-2, JCS-MAS-3, JCS-MAS-4, JCS-MOD613.
- › Enhanced version of Proto® J99931 Master Technician Maintenance Set.
- › Weight: 813.0 lbs.



Representative Image; Contents May Differ

613 PC MASTER TECHNICIAN MAINTENANCE SET WITH WORKSTATION J445442-14RD

Product #: JCS-0613MASBX2

- › 613 Pieces.
- › 1/4", 3/8", 1/2", 3/4" Drive Tools.
- › Designed for fastener sizes 1/16" - 2-3/8", 2 mm - 24 mm.
- › Contains: 305 Sockets and Accessories, 167 Wrenches, 33 Striking and Struck Tools, 22 Pliers, 32 Screwdrivers, 54 Miscellaneous Tools.
- › Modules contained: JCS-MAS-1, JCS-MAS-2, JCS-MAS-3, JCS-MAS-4, JCS-MOD613.
- › Enhanced version of Proto® J99932 Master Technician Maintenance Set.
- › Weight: 682.0 lbs.



Representative Image; Contents May Differ

497 PC MASTER TECHNICIAN MAINTENANCE TOOL SET

Product #: **J99920**



- › 497 Pieces.
- › 1/4", 3/8", 1/2" Drive Tools.
- › Designed for fastener sizes 1/16" - 1-1/2", 2.5 mm - 24 mm.
- › Tools Only.
- › Contains: 259 Sockets and Accessories, 128 Wrenches, 32 Striking and Struck Tools, 14 Pliers, 30 Screwdrivers, 34 Miscellaneous Tools.
- › Sub-sets contained: J99900, J99905, J99915.
- › Weight: 297.0 lbs.



Representative Image; Contents May Differ

| Contents | Description |
|-----------|----------------------------------|
| J4770A | Adapter, Universal Joint 1/4" DR |
| J5270A | Adapter, Universal Joint 3/8" DR |
| J5470A | Adapter, Universal Joint 1/2" DR |
| J86A3/16 | Chisel, Cold 1/4" |
| J86A1/4 | Chisel, Cold 5/16" |
| J86A5/16 | Chisel, Cold 3/8" |
| J86A7/16 | Chisel, Cold 1/2" |
| J86A1/2 | Chisel, Cold 5/8" |
| J86A5/8 | Chisel, Cold 3/4" |
| J86A3/4X8 | Chisel, Cold 7/8" |
| J86A7/8X8 | Chisel, Cold 1" |
| J86A1X8 | Chisel, Cold 1-3/16" |
| J4769 | Driver, 1/4" DR |
| J9521 | Extractor, Screw 1/8" |
| J9528 | Extractor, Screw 3/16" |
| J9525B | Extractor, Screw 15/64" |
| J9523 | Extractor, Screw 5/16" |
| J9527 | Extractor, Screw 3/8" |
| J9522 | Extractor, Screw 15/32" |
| J9525 | Extractor, Screw 9/16" |
| J9524 | Extractor, Screw 21/32" |
| J9526 | Extractor, Screw 13/16" |
| J9529 | Extractor, Screw 1-1/16" |
| J4759 | Extension, 1/4" DR 2" |
| J4760 | Extension, 1/4" DR 3" |
| J4761 | Extension, 1/4" DR 6" |
| J5260 | Extension, 3/8" DR 3" |
| J5260-06 | Extension, 3/8" DR 6" |
| J5262 | Extension, 3/8" DR 12" |
| J5460 | Extension, 1/2" DR 2-1/2" |
| J5461 | Extension, 1/2" DR 5" |
| J5463 | Extension, 1/2" DR 10" |
| J4765 | Extension, Flex 1/4" DR 6-1/4" |
| J5268 | Extension, Flex 3/8" DR 8" |
| J5260W | Extension, Wobble 3/8" DR 3" |
| J5260-06W | Extension, Wobble 3/8" DR 6" |
| 15-265 | Hacksaw, 3-7/8" |
| J1430-HB | Hammer Head |
| J1308PD | Hammer, Ball Pein 8 oz. |
| J1316PD | Hammer, Ball Pein 16 oz. |
| 57-532 | Hammer, Compo-Cast® 21 oz. |
| J5280G | Handle, Speed 3/8" DR |
| J5480G | Handle, Speed 1/2" DR |
| J5468 | Handle, Hinge 1/2" DR |
| J4766 | Handle, Hinge 1/4" DR 5-3/4" |
| J5265 | Handle, Hinge 3/8" DR 8-1/2" |
| J4785 | Handle, Sliding T 1/4" DR |
| J5285 | Handle, Sliding T 3/8" DR |
| J5485 | Handle, Sliding T 1/2" DR |
| J4980 | Hex Key, 13 PC Standard Set |





| Contents | Description |
|-----------------|---|
| J4984 | Hex Key, 9 PC Metric Set |
| J2108 | Holder, Punch and Chisel |
| 10-099 | Knife, Stanley® Classic 99® Retractable Blade Utility |
| J1368 | Mallet, Rubber |
| J2373 | Mirror, Rectangular Telescoping 2-1/8" |
| J9206 | Nut Driver, 3/16" |
| J9207 | Nut Driver, 7/32" |
| J9208 | Nut Driver, 1/4" |
| J9209 | Nut Driver, 9/32" |
| J9210 | Nut Driver, 5/16" |
| J9211 | Nut Driver, 11/32" |
| J9212 | Nut Driver, 3/8" |
| J9214 | Nut Driver 7/16" |
| J9216 | Nut Driver, 1/2" |
| J9218 | Nut Driver, 9/16" |
| J9220 | Nut Driver, 5/8" |
| J206G | Pliers, Diagonal Cutting with Grip 6-1/16" |
| J209G | Pliers, Diagonal Cutting with Grip 7-5/16" |
| J227G | Pliers, Duckbill with Grip 7-25/32" |
| J272G | Pliers, End Cutting High Leverage 8-1/4" |
| J268G | Pliers, Lineman's with Grip 8-5/8" |
| J292NC | Pliers, Locking Curved 10" |
| J291NC | Pliers, Locking Straight 7" |
| J225G | Pliers, Needle-Nose Bent Nose 6-5/16" |
| J222G | Pliers, Needle-Nose Long Thin 6-1/16" |
| J226G | Pliers, Needle-Nose with Cutter 6-5/8" |
| J276G | Pliers, Slip-Joint with Grip 6-9/16" |
| J278G | Pliers, Slip-Joint with Grip 8-1/16" |
| J298 | Pliers, Wire Strippers 8-1/4" |
| J413/8 | Punch, Center 3/8" |
| J411/2 | Punch, Center 1/2" |
| J965/16 | Punch, Drift 1/8" |
| J963/8 | Punch, Drift 3/16" |
| J961/2 | Punch, Drift 1/4" |
| J471/4X3/32 | Punch, Pin 3/32" |
| J475/16X1/8 | Punch, Pin 1/8" |
| J475/16X5/32 | Punch, Pin 5/32" |
| J473/8X3/16 | Punch, Pin 3/16" |
| J477/16X7/32 | Punch, Pin 7/32" |
| J471/2X1/4 | Punch, Pin 1/4" |
| J445/16 | Punch, Prick 5/16" |
| J501/4 | Punch, Starting 3/32" |
| J505/16 | Punch, Starting 1/8" |
| J503/8 | Punch, Starting 3/16" |
| J501/2 | Punch, Starting 1/4" |
| J507/16 | Punch, Starting 7/32" |
| J4749 | Ratchet, 1/4" DR |
| J5249 | Ratchet, 3/8" DR |
| J5449 | Ratchet, 1/2" DR |
| J5450 | Ratchet, 1/2" DR (Long Handle) |
| J5247 | Ratchet Adapter 3/8" DR 2-1/16" |
| J5447 | Ratchet Adapter 1/2" DR 2-21/32" |
| J5257F | Ratchet, 3/8" DR Flex-Head 2-1/16" |
| J5457F | Ratchet, 1/2" DR Flex-Head 17-3/32" |
| J2375 | Retrieval Tool, Pocket Magnetic |
| J88208 | Screwdriver, Slotted Cabinet, Round 1/8" x 8" |
| J88204 | Screwdriver, Slotted Cabinet, Round 1/8" x 4" |
| J88203 | Screwdriver, Slotted Cabinet, Round 1/8" x 3" |

| Contents | Description |
|-----------------|--|
| J88218 | Screwdriver, Slotted Cabinet, Round 3/16" x 8" |
| J88214 | Screwdriver, Slotted Cabinet, Round 3/16" x 4" |
| J88393 | Screwdriver, Phillips® #0 |
| J88318 | Screwdriver, Phillips® #1 |
| J88313 | Screwdriver, Phillips® #1 |
| J88328 | Screwdriver, Phillips® #2 |
| J88324 | Screwdriver, Phillips® #2 |
| J88322 | Screwdriver, Phillips® #2 |
| J88336 | Screwdriver, Phillips® #3 |
| J88348 | Screwdriver, Phillips® #4 |
| J88102 | Screwdriver, Slotted Keystone, Square 1/4" x 2" |
| J88104 | Screwdriver, Slotted Keystone, Square 1/4" x 4" |
| J88106 | Screwdriver, Slotted Keystone, Square 1/4" x 6" |
| J88108 | Screwdriver, Slotted Keystone, Square 1/4" x 8" |
| J88112 | Screwdriver, Slotted Keystone, Square 1/4" x 12" |
| J88002 | Screwdriver, Slotted Keystone, Round 1/4" x 1-1/2" |
| J303S | Snips, Aviation Straight |
| J4706 | Socket, 1/4" DR 3/16" 6 PT |
| J4707 | Socket, 1/4" DR 7/32" 6 PT |
| J4708 | Socket, 1/4" DR 1/4" 6 PT |
| J4709 | Socket, 1/4" DR 9/32" 6 PT |
| J4710 | Socket, 1/4" DR 5/16" 6 PT |
| J4711 | Socket, 1/4" DR 11/32" 6 PT |
| J4712 | Socket, 1/4" DR 3/8" 6 PT |
| J4714 | Socket, 1/4" DR 7/16" 6 PT |
| J4716 | Socket, 1/4" DR 1/2" 6 PT |
| J4718 | Socket, 1/4" DR 9/16" 6 PT |
| J4704M | Socket, 1/4" DR 4 mm 6 PT |
| J4705M | Socket, 1/4" DR 5 mm 6 PT |
| J47055M | Socket, 1/4" DR 5.5 mm 6 PT |
| J4706M | Socket, 1/4" DR 6 mm 6 PT |
| J4707M | Socket, 1/4" DR 7 mm 6 PT |
| J4708M | Socket, 1/4" DR 8 mm 6 PT |
| J4709M | Socket, 1/4" DR 9 mm 6 PT |
| J4710M | Socket, 1/4" DR 10 mm 6 PT |
| J4711M | Socket, 1/4" DR 11 mm 6 PT |
| J4712M | Socket, 1/4" DR 12 mm 6 PT |
| J4713M | Socket, 1/4" DR 13 mm 6 PT |
| J4714M | Socket, 1/4" DR 14 mm 6 PT |
| J4706L | Socket, 1/4" DR 3/16" 6 PT Deep |
| J4707L | Socket, 1/4" DR 7/32" 6 PT Deep |
| J4708L | Socket, 1/4" DR 1/4" 6 PT Deep |
| J4709L | Socket, 1/4" DR 9/32" 6 PT Deep |
| J4710L | Socket, 1/4" DR 5/16" 6 PT Deep |
| J4711L | Socket, 1/4" DR 11/32" 6 PT Deep |
| J4712L | Socket, 1/4" DR 3/8" 6 PT Deep |
| J4714L | Socket, 1/4" DR 7/16" 6 PT Deep |
| J4716L | Socket, 1/4" DR 1/2" 6 PT Deep |
| J4718L | Socket, 1/4" DR 9/16" 6 PT Deep |
| J4704LM | Socket, 1/4" DR 4 mm 6 PT Deep |
| J4705LM | Socket, 1/4" DR 5 mm 6 PT Deep |
| J47055LM | Socket, 1/4" DR 5.5 mm 6 PT Deep |
| J4706LM | Socket, 1/4" DR 6 mm 6 PT Deep |
| J4707LM | Socket, 1/4" DR 7 mm 6 PT Deep |
| J4708LM | Socket, 1/4" DR 8 mm 6 PT Deep |
| J4709LM | Socket, 1/4" DR 9 mm 6 PT Deep |
| J4710LM | Socket, 1/4" DR 10 mm 6 PT Deep |
| J4711LM | Socket, 1/4" DR 11 mm 6 PT Deep |

(CONTINUED ON NEXT PAGE)

497 PC MASTER TECHNICIAN MAINTENANCE TOOL SET (CONTINUED)

Product #: J99920



| Contents | Description | Contents | Description |
|----------|-----------------------------------|----------|-----------------------------------|
| J4712LM | Socket, 1/4" DR 12 mm 6 PT Deep | J5015M | Socket, 3/8" DR 15 mm 12 PT Deep |
| J4713LM | Socket, 1/4" DR 13 mm 6 PT Deep | J5016M | Socket, 3/8" DR 16 mm 12 PT Deep |
| J4714LM | Socket, 1/4" DR 14 mm 6 PT Deep | J5017M | Socket, 3/8" DR 17 mm 12 PT Deep |
| J4708S | Socket, 1/4" DR 1/4" 8 PT | J5018M | Socket, 3/8" DR 18 mm 12 PT Deep |
| J4712S | Socket, 1/4" DR 3/8" 8 PT | J5019M | Socket, 3/8" DR 19 mm 12 PT Deep |
| J4710S | Socket, 1/4" DR 5/16" 8 PT | J5412S | Socket, 1/2" DR 3/8" 8 PT |
| J5216S | Socket, 3/8" DR 1/2" 8 PT | J5414S | Socket, 1/2" DR 7/16" 8 PT |
| J5208S | Socket, 3/8" DR 1/4" 8 PT | J5416S | Socket, 1/2" DR 1/2" 8 PT |
| J5212S | Socket, 3/8" DR 3/8" 8 PT | J5418S | Socket, 1/2" DR 9/16" 8 PT |
| J5210S | Socket, 3/8" DR 5/16" 8 PT | J5420S | Socket, 1/2" DR 5/8" 8 PT |
| J5214S | Socket, 3/8" DR 7/16" 8 PT | J5422S | Socket, 1/2" DR 11/16" 8 PT |
| J5208 | Socket, 3/8" DR 1/4" 12 PT | J5424S | Socket, 1/2" DR 3/4" 8 PT |
| J5210 | Socket, 3/8" DR 5/16" 12 PT | J5426S | Socket, 1/2" DR 13/16" 8 PT |
| J5212 | Socket, 3/8" DR 3/8" 12 PT | J5428S | Socket, 1/2" DR 7/8" 8 PT |
| J5216 | Socket, 3/8" DR 1/2" 12 PT | J5432S | Socket, 1/2" DR 1" 8 PT |
| J5220 | Socket, 3/8" DR 5/8" 12 PT | J5416 | Socket, 1/2" DR 1/2" 12 PT |
| J5214 | Socket, 3/8" DR 7/16" 12 PT | J5419 | Socket, 1/2" DR 19/32" 12 PT |
| J5224 | Socket, 3/8" DR 3/4" 12 PT | J5422 | Socket, 1/2" DR 11/16" 12 PT |
| J5218 | Socket, 3/8" DR 9/16" 12 PT | J5424 | Socket, 1/2" DR 3/4" 12 PT |
| J5222 | Socket, 3/8" DR 11/16" 12 PT | J5425 | Socket, 1/2" DR 25/32" 12 PT |
| J5226 | Socket, 3/8" DR 13/16" 12 PT | J5426 | Socket, 1/2" DR 13/16" 12 PT |
| J5228 | Socket, 3/8" DR 7/8" 12 PT | J5429 | Socket, 1/2" DR 29/32" 12 PT |
| J5230 | Socket, 3/8" DR 15/16" 12 PT | J5428 | Socket, 1/2" DR 7/8" 12 PT |
| J5232 | Socket, 3/8" DR 1" 12 PT | J5430 | Socket, 1/2" DR 15/16" 12 PT |
| J5208M | Socket, 3/8" DR 8 mm 12 PT | J5432 | Socket, 1/2" DR 1" 12 PT |
| J5209M | Socket, 3/8" DR 9 mm 12 PT | J5434 | Socket, 1/2" DR 1-1/16" 12 PT |
| J5210M | Socket, 3/8" DR 10 mm 12 PT | J5436 | Socket, 1/2" DR 1-1/8" 12 PT |
| J5211M | Socket, 3/8" DR 11 mm 12 PT | J5438 | Socket, 1/2" DR 1-3/16" 12 PT |
| J5212M | Socket, 3/8" DR 12 mm 12 PT | J5440 | Socket, 1/2" DR 1-1/4" 12 PT |
| J5213M | Socket, 3/8" DR 13 mm 12 PT | J5442 | Socket, 1/2" DR 1-5/16" 12 PT |
| J5214M | Socket, 3/8" DR 14 mm 12 PT | J5444 | Socket, 1/2" DR 1-3/8" 12 PT |
| J5215M | Socket, 3/8" DR 15 mm 12 PT | J5446 | Socket, 1/2" DR 1-7/16" 12 PT |
| J5216M | Socket, 3/8" DR 16 mm 12 PT | J5448 | Socket, 1/2" DR 1-1/2" 12 PT |
| J5217M | Socket, 3/8" DR 17 mm 12 PT | J5410M | Socket, 1/2" DR 10 mm 12 PT |
| J5218M | Socket, 3/8" DR 18 mm 12 PT | J5411M | Socket, 1/2" DR 11 mm 12 PT |
| J5219M | Socket, 3/8" DR 19 mm 12 PT | J5412M | Socket, 1/2" DR 12 mm 12 PT |
| J5008 | Socket, 3/8" DR 1/4" 12 PT Deep | J5413M | Socket, 1/2" DR 13 mm 12 PT |
| J5010 | Socket, 3/8" DR 5/16" 12 PT Deep | J5414M | Socket, 1/2" DR 14 mm 12 PT |
| J5012 | Socket, 3/8" DR 3/8" 12 PT Deep | J5415M | Socket, 1/2" DR 15 mm 12 PT |
| J5014 | Socket, 3/8" DR 7/16" 12 PT Deep | J5416M | Socket, 1/2" DR 16 mm 12 PT |
| J5016 | Socket, 3/8" DR 1/2" 12 PT Deep | J5417M | Socket, 1/2" DR 17 mm 12 PT |
| J5020 | Socket, 3/8" DR 5/8" 12 PT Deep | J5418M | Socket, 1/2" DR 18 mm 12 PT |
| J5018 | Socket, 3/8" DR 9/16" 12 PT Deep | J5419M | Socket, 1/2" DR 19 mm 12 PT |
| J5022 | Socket, 3/8" DR 11/16" 12 PT Deep | J5420M | Socket, 1/2" DR 20 mm 12 PT |
| J5024 | Socket, 3/8" DR 3/4" 12 PT Deep | J5421M | Socket, 1/2" DR 21 mm 12 PT |
| J5026 | Socket, 3/8" DR 13/16" 12 PT Deep | J5422M | Socket, 1/2" DR 22 mm 12 PT |
| J5028 | Socket, 3/8" DR 7/8" 12 PT Deep | J5423M | Socket, 1/2" DR 23 mm 12 PT |
| J5030 | Socket, 3/8" DR 15/16" 12 PT Deep | J5424M | Socket, 1/2" DR 24 mm 12 PT |
| J5032 | Socket, 3/8" DR 1" 12 PT Deep | J5316 | Socket, 1/2" DR 1/2" 12 PT Deep |
| J5008M | Socket, 3/8" DR 8 mm 12 PT Deep | J5318 | Socket, 1/2" DR 9/16" 12 PT Deep |
| J5009M | Socket, 3/8" DR 9 mm 12 PT Deep | J5320 | Socket, 1/2" DR 5/8" 12 PT Deep |
| J5010M | Socket, 3/8" DR 10 mm 12 PT Deep | J5322 | Socket, 1/2" DR 11/16" 12 PT Deep |
| J5011M | Socket, 3/8" DR 11 mm 12 PT Deep | J5326 | Socket, 1/2" DR 13/16" 12 PT Deep |
| J5012M | Socket, 3/8" DR 12 mm 12 PT Deep | J5328 | Socket, 1/2" DR 7/8" 12 PT Deep |
| J5013M | Socket, 3/8" DR 13 mm 12 PT Deep | J5330 | Socket, 1/2" DR 15/16" 12 PT Deep |
| J5014M | Socket, 3/8" DR 14 mm 12 PT Deep | J5332 | Socket, 1/2" DR 1" 12 PT Deep |





| Contents | Description |
|------------|---|
| J5334 | Socket, 1/2" DR 1-1/16" 12 PT Deep |
| J5336 | Socket, 1/2" DR 1-1/8" 12 PT Deep |
| J5340 | Socket, 1/2" DR 1-1/4" 12 PT Deep |
| J5324 | Socket, 1/2" DR 3/4" 12 PT Deep |
| J5412 | Socket, 1/2" DR 3/8" 12 PT |
| J5420 | Socket, 1/2" DR 5/8" 12 PT |
| J5414 | Socket, 1/2" DR 7/16" 12 PT |
| J5418 | Socket, 1/2" DR 9/16" 12 PT |
| J5444A | Socket, 1/2" DR Drag Link 3/4" |
| J4737 | Socket, Bit 1/4" DR #1 Phillips® |
| J4738 | Socket, Bit 1/4" DR #2 Phillips® |
| J4743 | Socket, Bit 1/4" DR Slotted 1/4" 1-3/16" |
| J4744 | Socket, Bit 1/4" DR Slotted 3/16" |
| J4745 | Socket, Bit 1/4" DR Slotted 1/4" 1-13/64" |
| J5241 | Socket, Bit 3/8" DR #2 Phillips® |
| J5242 | Socket, Bit 3/8" DR #3 Phillips® |
| J5243 | Socket, Bit 3/8" DR #4 Phillips® |
| J5246 | Socket, Bit 3/8" DR Slotted |
| J47701/16 | Socket, Hex Bit 1/4" DR 1/16" |
| J47705/64 | Socket, Hex Bit 1/4" DR 5/64" |
| J47703/32 | Socket, Hex Bit 1/4" DR 3/32" |
| J47707/64 | Socket, Hex Bit 1/4" DR 7/64" |
| J47701/8 | Socket, Hex Bit 1/4" DR 1/8" |
| J47709/64 | Socket, Hex Bit 1/4" DR 9/64" |
| J47705/32 | Socket, Hex Bit 1/4" DR 5/32" |
| J47703/16 | Socket, Hex Bit 1/4" DR 3/16" |
| J47707/32 | Socket, Hex Bit 1/4" DR 7/32" |
| J47701/4 | Socket, Hex Bit 1/4" DR 1/4" |
| J47705/16 | Socket, Hex Bit 1/4" DR 5/16" |
| J4770-2M | Socket, Hex Bit 1/4" DR 2 mm |
| J4770-2.5M | Socket, Hex Bit 1/4" DR 2.5 mm |
| J4770-3M | Socket, Hex Bit 1/4" DR 3 mm |
| J4770-4M | Socket, Hex Bit 1/4" DR 4 mm |
| J4770-5M | Socket, Hex Bit 1/4" DR 5 mm |
| J4770-6M | Socket, Hex Bit 1/4" DR 6 mm |
| J49901/8 | Socket, Hex Bit 3/8" DR 1/8 |
| J49901/4 | Socket, Hex Bit 3/8" DR 1/4" |
| J49903/8 | Socket, Hex Bit 3/8" DR 3/8" |
| J54411/4 | Socket, Hex Bit 1/2" DR 1/4" |
| J54415/16 | Socket, Hex Bit 1/2" DR 5/16" |
| J54413/8 | Socket, Hex Bit 1/2" DR 3/8" |
| J54417/16 | Socket, Hex Bit 1/2" DR 7/16" |
| J54411/2 | Socket, Hex Bit 1/2" DR 1/2" |
| J54419/16 | Socket, Hex Bit 1/2" DR 9/16" |
| J54415/8 | Socket, Hex Bit 1/2" DR 5/8" |
| J5441-12M | Socket, Hex Bit 1/2" DR 12 mm |
| J5441-14M | Socket, Hex Bit 1/2" DR 14 mm |
| J5441-17M | Socket, Hex Bit 1/2" DR 17 mm |
| J49905/32 | Socket, Hex Bit 3/8" DR 5/32" |
| J49903/16 | Socket, Hex Bit 3/8" DR 3/16" |
| J49907/32 | Socket, Hex Bit 3/8" DR 7/32" |
| J49905/16 | Socket, Hex Bit 3/8" DR 5/16" |
| J4990-4M | Socket, Hex Bit 3/8" DR 4 mm |
| J4990-5M | Socket, Hex Bit 3/8" DR 5 mm |
| J4990-6M | Socket, Hex Bit 3/8" DR 6 mm |
| J4990-7M | Socket, Hex Bit 3/8" DR 7 mm |
| J4990-8M | Socket, Hex Bit 3/8" DR 8 mm |
| J4990-9M | Socket, Hex Bit 3/8" DR 9 mm |

| Contents | Description |
|-----------|---|
| J4990-10M | Socket, Hex Bit 3/8" DR 10 mm |
| J5273A | Socket, Universal 3/8" DR 3/8" 12 PT |
| J5274A | Socket, Universal 3/8" DR 7/16" 12 PT |
| J5275A | Socket, Universal 3/8" DR 1/2" 12 PT |
| J5276A | Socket, Universal 3/8" DR 9/16" 12 PT |
| J5277A | Socket, Universal 3/8" DR 5/8" 12 PT |
| J5278A | Socket, Universal 3/8" DR 11/16" 12 PT |
| J5279A | Socket, Universal 3/8" DR 3/4" 12 PT |
| J4771TA | Socket, Universal 1/4" DR 1/4" 12 PT |
| J4772TA | Socket, Universal 1/4" DR 5/16" 12 PT |
| J4773TA | Socket, Universal 1/4" DR 3/8" 12 PT |
| J4774TA | Socket, Universal 1/4" DR 7/16" 12 PT |
| J5475A | Socket, Universal 1/2" DR 1/2" 12 PT |
| J5476A | Socket, Universal 1/2" DR 9/16" 12 PT |
| J5477A | Socket, Universal 1/2" DR 5/8" 12 PT |
| 33-212 | Tape Rule, Stanley® Powerlock® with Metal Case 1/2" x 12' |
| J706 | Wrench, Adjustable 6" |
| J708 | Wrench, Adjustable 8" |
| J710 | Wrench, Adjustable 10" |
| J1170 | Wrench, Box 5/16" x 3/8" 12 PT |
| J1171 | Wrench, Box 7/16" x 1/2" 12 PT |
| J1172 | Wrench, Box 9/16" x 5/8" 12 PT |
| J1173 | Wrench, Box 11/16" x 3/4" 12 PT |
| J1174 | Wrench, Box 13/16" x 7/8" 12 PT |
| J1175 | Wrench, Box 15/16" x 1" 12 PT |
| J1176 | Wrench, Box 1-1/16" x 1-1/8" 12 PT |
| J1050M | Wrench, Box 6 x 7 mm 12 PT |
| J1051M | Wrench, Box 8 x 9 mm 12 PT |
| J1053M | Wrench, Box 10 x 11 mm 12 PT |
| J1057M | Wrench, Box 12 x 13 mm 12 PT |
| J1061M | Wrench, Box 14 x 15 mm 12 PT |
| J1064M | Wrench, Box 16 x 18 mm 12 PT |
| J1065M | Wrench, Box 17 x 19 mm 12 PT |
| J1072M | Wrench, Box 21 x 24 mm 12 PT |
| J1073M | Wrench, Box 22 x 24 mm 12 PT |
| J1077M | Wrench, Box 27 x 30 mm 12 PT |
| J1079M | Wrench, Box 30 x 32 mm 12 PT |
| J1210A | Wrench, Combination 5/16" 12 PT |
| J1212ASD | Wrench, Combination 3/8" 12 PT |
| J1214ASD | Wrench, Combination 7/16" 12 PT |
| J1216ASD | Wrench, Combination 1/2" 12 PT |
| J1218ASD | Wrench, Combination 9/16" 12 PT |
| J1220ASD | Wrench, Combination 5/8" 12 PT |
| J1222ASD | Wrench, Combination 11/16" 12 PT |
| J1224ASD | Wrench, Combination 3/4" 12 PT |
| J1226ASD | Wrench, Combination 13/16" 12 PT |
| J1228ASD | Wrench, Combination 7/8" 12 PT |
| J1230ASD | Wrench, Combination 15/16" 12 PT |
| J1232ASD | Wrench, Combination 1" 12 PT |
| J1234ASD | Wrench, Combination 1-1/16" 12 PT |
| J1236ASD | Wrench, Combination 1-1/8" 12 PT |
| J1240ASD | Wrench, Combination 1-1/4" 12 PT |
| J1244 | Wrench, Combination 1-3/8" 12 PT |
| J1242 | Wrench, Combination 1-5/16" 12 PT |
| J1246 | Wrench, Combination 1-7/16" 12 PT |
| J1248 | Wrench, Combination 1-1/2" 12 PT |
| J1207MA | Wrench, Combination 7 mm 12 PT |

(CONTINUED ON NEXT PAGE)



497 PC MASTER TECHNICIAN MAINTENANCE TOOL SET (CONTINUED)

Product #: J99920



| Contents | Description | Contents | Description |
|-----------|--|-----------|--|
| J1208MA | Wrench, Combination 8 mm 12 PT | J3710M | Wrench, Flare Nut 10 mm x 12 mm |
| J1209MA | Wrench, Combination 9 mm 12 PT | J3713M | Wrench, Flare Nut 13 mm x 14 mm |
| J1210MASD | Wrench, Combination 10 mm 12 PT | J3715M | Wrench, Flare Nut 15 mm x 17 mm |
| J1211MASD | Wrench, Combination 11 mm 12 PT | J3751 | Wrench, Flare Nut Combination 3/8" 6 PT |
| J1212MASD | Wrench, Combination 12 mm 12 PT | J3752 | Wrench, Flare Nut Combination 7/16" 6 PT |
| J1213MASD | Wrench, Combination 13 mm 12 PT | J3753 | Wrench, Flare Nut Combination 1/2" 6 PT |
| J1214MASD | Wrench, Combination 14 mm 12 PT | J3754 | Wrench, Flare Nut Combination 9/16" 6 PT |
| J1215MASD | Wrench, Combination 15 mm 12 PT | J3755 | Wrench, Flare Nut Combination 5/8" 6 PT |
| J1216MASD | Wrench, Combination 16 mm 12 PT | J3756 | Wrench, Flare Nut Combination 11/16" 6 PT |
| J1217MASD | Wrench, Combination 17 mm 12 PT | J3757 | Wrench, Flare Nut Combination 3/4" 6 PT |
| J1218MASD | Wrench, Combination 18 mm 12 PT | J3018 | Wrench, Open End 1/4" x 5/16" |
| J1219MASD | Wrench, Combination 19 mm 12 PT | J3020 | Wrench, Open End 3/8" x 5/16" |
| J1220MASD | Wrench, Combination 20 mm 12 PT | J3025 | Wrench, Open End 7/16" x 1/2" |
| J1221MASD | Wrench, Combination 21 mm 12 PT | J3026 | Wrench, Open End 1/2" x 9/16" |
| J1222MASD | Wrench, Combination 22 mm 12 PT | J3030 | Wrench, Open End 9/16" x 5/8" |
| J1223MASD | Wrench, Combination 23 mm 12 PT | J3031 | Wrench, Open End 5/8" x 3/4" |
| J1224MASD | Wrench, Combination 24 mm 12 PT | J3035 | Wrench, Open End 11/16" x 3/4" |
| J4912CF | Wrench, Crowfoot 3/8" DR 3/8" Open End | J3040 | Wrench, Open End 13/16" x 7/8" |
| J4914CF | Wrench, Crowfoot 3/8" DR 7/16" Open End | J3045 | Wrench, Open End 15/16" x 1" |
| J4916CF | Wrench, Crowfoot 3/8" DR 1/2" Open End | J3050 | Wrench, Open End 1-1/16" x 1-1/8" |
| J4918CF | Wrench, Crowfoot 3/8" DR 9/16" Open End | J30607 | Wrench, Open End 6 mm x 7 mm |
| J4920CF | Wrench, Crowfoot 3/8" DR 5/8" Open End | J30809 | Wrench, Open End 8 mm x 9 mm |
| J4922CF | Wrench, Crowfoot 3/8" DR 11/16" Open End | J31011 | Wrench, Open End 10 mm x 11 mm |
| J4924CF | Wrench, Crowfoot 3/8" DR 3/4" Open End | J31213 | Wrench, Open End 12 mm x 13 mm |
| J4926CF | Wrench, Crowfoot 3/8" DR 13/16" Open End | J31415 | Wrench, Open End 14 mm x 15 mm |
| J4928CF | Wrench, Crowfoot 3/8" DR 7/8" Open End | J31617 | Wrench, Open End 16 mm x 17 mm |
| J4909MCF | Wrench, Crowfoot 3/8" DR 9 mm Open End | J31819 | Wrench, Open End 18 mm x 19 mm |
| J4910MCF | Wrench, Crowfoot 3/8" DR 10 mm Open End | J32022 | Wrench, Open End 20 mm x 22 mm |
| J4911MCF | Wrench, Crowfoot 3/8" DR 11 mm Open End | J32123 | Wrench, Open End 21 mm x 23 mm |
| J4912MCF | Wrench, Crowfoot 3/8" DR 12 mm Open End | J32426 | Wrench, Open End 24 mm x 26 mm |
| J4913MCF | Wrench, Crowfoot 3/8" DR 13 mm Open End | J810HD | Wrench, Pipe Heavy-Duty 10" |
| J4914MCF | Wrench, Crowfoot 3/8" DR 14 mm Open End | J814HD | Wrench, Pipe Heavy-Duty 14" |
| J4915MCF | Wrench, Crowfoot 3/8" DR 15 mm Open End | J1191T-A | Wrench, Ratcheting Box 1/4" x 5/16" 12 PT |
| J4916MCF | Wrench, Crowfoot 3/8" DR 16 mm Open End | J1192T-A | Wrench, Ratcheting Box 3/8" x 7/16" 12 PT |
| J4917MCF | Wrench, Crowfoot 3/8" DR 17 mm Open End | J1193T-A | Wrench, Ratcheting Box 1/2" x 9/16" 12 PT |
| J4918MCF | Wrench, Crowfoot 3/8" DR 18 mm Open End | J1194-A | Wrench, Ratcheting Box 5/8" x 11/16" 12 PT |
| J4919MCF | Wrench, Crowfoot 3/8" DR 19 mm Open End | J1195-A | Wrench, Ratcheting Box 3/4" x 7/8" 12 PT |
| J4920MCF | Wrench, Crowfoot 3/8" DR 20 mm Open End | J1191M-A | Wrench, Ratcheting Box 7 mm x 8 mm |
| J4921MCF | Wrench, Crowfoot 3/8" DR 21 mm Open End | J1192M-A | Wrench, Ratcheting Box 9 mm x 10 mm |
| J4922MCF | Wrench, Crowfoot 3/8" DR 22 mm Open End | J1193MA-A | Wrench, Ratcheting Box 11 mm x 12 mm |
| J4923MCF | Wrench, Crowfoot 3/8" DR 23 mm Open End | J1194MA-A | Wrench, Ratcheting Box 13 mm x 14 mm |
| J4924MCF | Wrench, Crowfoot 3/8" DR 24 mm Open End | J1195M-A | Wrench, Ratcheting Box 15 mm x 17 mm |
| J3707M | Wrench, Flare Nut 7 mm x 8 mm | J6014C | Wrench, Torque 1/2" DR 50-250 ft-lbs |
| J3709M | Wrench, Flare Nut 9 mm x 11 mm | | |



497 PC MASTER TECHNICIAN MAINTENANCE SET WITH ROLLER CABINET J442742-8RD AND TOP CHEST J442719-12RD-D

Product #: J99921



- › 497 Pieces.
- › 1/4", 3/8", 1/2" Drive Tools.
- › Designed for fastener sizes 1/16" - 1-1/2", 2.5 mm - 24 mm.
- › Contains: 266 Sockets and Accessories, 125 Wrenches, 32 Striking and Struck Tools, 13 Pliers, 19 Screwdrivers, 42 Miscellaneous Tools.
- › Sub-sets contained: J99900, J99905, J99915.
- › Weight: 640.0 lbs.

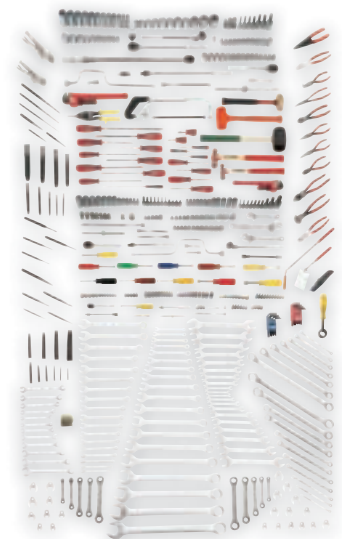

Representative Image; Contents May Differ

497 PC MASTER TECHNICIAN MAINTENANCE SET WITH ROLLER CABINET J453441-8RD AND TOP CHEST J453427-6RD

Product #: J99922



- › 497 Pieces.
- › 1/4", 3/8", 1/2" Drive Tools.
- › Designed for fastener sizes 1/16" - 1-1/2", 2.5 mm - 24 mm.
- › Contains: 266 Sockets and Accessories, 125 Wrenches, 32 Striking and Struck Tools, 13 Pliers, 19 Screwdrivers, 42 Miscellaneous Tools.
- › Sub-sets contained: J99900, J99905, J99915.
- › Weight: 826.0 lbs.

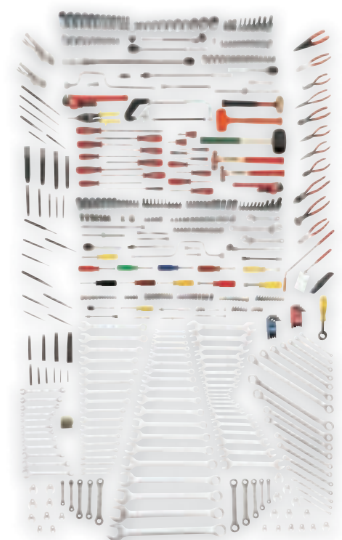

Representative Image; Contents May Differ



272 PC MASTER TOOL SET

Product #: J99710

- › 272 Pieces.
- › 1/4", 3/8", 1/2", 3/4" Drive Tools.
- › Designed for fastener sizes 3/16" - 2".
- › Tools only.

- › Contains: 121 Sockets and Accessories, 54 Wrenches, 17 Striking and Struck Tools, 28 Pliers, 19 Screwdrivers, 33 Miscellaneous Tools.
- › Weight: 216.0 lbs.



Representative Image; Contents May Differ

| Contents | Description |
|----------|---|
| J4770A | Adapter, Universal Joint 1/4" DR |
| J5270A | Adapter, Universal Joint 3/8" DR |
| J5470A | Adapter, Universal Joint 1/2" DR |
| J2126 | Bar, 12" Long 1/2" Tip |
| J2120 | Bar, Pry Aligning 18" |
| J404 | C-Clamps, Capacity 0"-4", 2 Each |
| J725/16 | Chisel, Cape 13/64" |
| J86A1/4 | Chisel, Cold 5/16" |
| J86A3/8 | Chisel, Cold 7/16" |
| J86A7/16 | Chisel, Cold 1/2" |
| J765/16 | Chisel, Diamond PT 3/16" |
| J4769 | Driver, 1/4" DR |
| J9521 | Extractor, Screw 1/8" |
| J9522 | Extractor, Screw 3/16" |
| J9523 | Extractor, Screw 15/64" |
| J9525 | Extractor, Screw 5/16" |
| J9524 | Extractor, Screw 3/8" |
| J9525B | Extractor, Screw 15/32" |
| J9526 | Extractor, Screw 9/16" |
| J9527 | Extractor, Screw 21/32" |
| J9528 | Extractor, Screw 13/16" |
| J9529 | Extractor, Screw 1-1/16" |
| J4759 | Extension, 1/4" DR 2" |
| J4761 | Extension, 1/4" DR 6" |
| J5260 | Extension, 3/8" DR 3" |
| J5260-06 | Extension, 3/8" DR 6" |
| J5262 | Extension, 3/8" DR 12" |
| J5460 | Extension, 1/2" DR 2-1/2" |
| J5461 | Extension, 1/2" DR 5" |
| J5661 | Extension, 3/4" DR 8" |
| J5463 | Extension, 1/2" DR 10" |
| J5663 | Extension, 3/4" DR 16" |
| J5696 | Box, Extra Heavy-Duty Set |
| J95218 | Knife, Folding Blade |
| 15-265 | Hacksaw, 3-7/8" |
| J1430-HB | Hammer Head |
| J1316PD | Hammer, Ball Pein 16 oz. |
| J1332PD | Hammer, Ball Pein 32 oz. |
| 57-532 | Hammer, Compo-Cast® 21 oz. |
| J4766 | Handle, Hinge 1/4" DR 5-3/4" |
| J5265 | Handle, Hinge 3/8" DR 8-1/2" |
| J5668 | Handle, Hinge 3/4" DR 20" |
| J5280G | Handle, Speed 3/8" DR |
| J5480G | Handle, Speed 1/2" DR |
| J4980 | Hex Key, 13 PC Standard Set |
| J5467 | Handle, Hinge 1/2" DR 15-3/4" |
| J2108 | Holder, Punch and Chisel |
| J18545B | Knife, Lockback 5" |
| 10-099 | Knife, Stanley® Classic 99® Retractable Blade Utility |
| J9206 | Nut Driver, 3/16" |





| Contents | Description |
|-----------------|--|
| J9207 | Nut Driver, 7/32" |
| J9208 | Nut Driver, 1/4" |
| J9209 | Nut Driver, 9/32" |
| J9210 | Nut Driver, 5/16" |
| J9211 | Nut Driver, 11/32" |
| J9212 | Nut Driver, 3/8" |
| J206G | Pliers, Diagonal Cutting with Grip 6-1/16" |
| J209G | Pliers, Diagonal Cutting with Grip 7-5/16" |
| J227G | Pliers, Duckbill with Grip 7-25/32" |
| J272G | Pliers, End Cutting High Leverage 8-1/4" |
| J268G | Pliers, Lineman's with Grip 8-5/8" |
| J292NC | Pliers, Locking Curved 10" |
| J291NC | Pliers, Locking Straight 7" |
| J225G | Pliers, Needle-Nose Bent Nose 6-5/16" |
| J222G | Pliers, Needle-Nose Long Thin 6-1/16" |
| J226G | Pliers, Needle-Nose with Cutter 6-5/8" |
| J360B | Pliers, 12 PC Set Convertible Retaining Ring |
| J278G | Pliers, Slip-Joint with Grip 8-1/16" |
| J260SG | Pliers, Tongue and Groove 10-3/16" with Grip |
| J265SG | Pliers, Tongue and Groove 16" with Grip |
| J298 | Pliers, Wire Strippers 8-1/4" |
| J2306 | Puller, Cotter Pin Tool |
| J4206CA | Puller, Crossarm 6 Ton 2 Way |
| J4026A | Puller, Jaw 6 Ton |
| J4027 | Puller, Jaw 6 Ton Narrow |
| J4205S | Puller, Screw Forcing Acme |
| J4029 | Puller, Set Box |
| J4021S | Puller, Spring Clip |
| J4022T | Puller, Tip Detachable Standard |
| J413/8 | Punch, Center 3/8" |
| J471/4X3/32 | Punch, Pin 3/32" |
| J475/16X1/8 | Punch, Pin 1/8" |
| J473/8X3/16 | Punch, Pin 3/16" |
| J503/16 | Punch, Starting 1/16" |
| J505/16 | Punch, Starting 1/8" |
| J503/8 | Punch, Starting 3/16" |
| J4749 | Ratchet, 1/4" DR |
| J5249 | Ratchet, 3/8" DR |
| J5449 | Ratchet, 1/2" DR |
| J5649 | Ratchet, 3/4" DR |
| J2336 | Scrapers, Gasket and Carbon |
| J88393 | Screwdriver, Phillips® #0 |
| J88313 | Screwdriver, Phillips® #1 |
| J88324 | Screwdriver, Phillips® #2 |
| J88322 | Screwdriver, Phillips® #2 |
| J88336 | Screwdriver, Phillips® #3 |
| J88348 | Screwdriver, Phillips® #4 |
| J88102 | Screwdriver, Slotted Keystone, Square 1/4" x 2" |
| J88104 | Screwdriver, Slotted Keystone, Square 1/4" x 4" |
| J88106 | Screwdriver, Slotted Keystone, Square 1/4" x 6" |
| J88108 | Screwdriver, Slotted Keystone, Square 1/4" x 8" |
| J88112 | Screwdriver, Slotted Keystone, Square 1/4" x 12" |
| J88002 | Screwdriver, Slotted Keystone, Round 1/4" x 1-1/2" |
| J303S | Snips, Aviation Straight |
| J308 | Snips, Miniature |
| J4706 | Socket, 1/4" DR 3/16" 6 PT |
| J4707 | Socket, 1/4" DR 7/32" 6 PT |
| J4708 | Socket, 1/4" DR 1/4" 6 PT |

| Contents | Description |
|-----------------|------------------------------------|
| J4709 | Socket, 1/4" DR 9/32" 6 PT |
| J4710 | Socket, 1/4" DR 5/16" 6 PT |
| J4711 | Socket, 1/4" DR 11/32" 6 PT |
| J4712 | Socket, 1/4" DR 3/8" 6 PT |
| J4714 | Socket, 1/4" DR 7/16" 6 PT |
| J4716 | Socket, 1/4" DR 1/2" 6 PT |
| J4706L | Socket, 1/4" DR 3/16" 6 PT Deep |
| J4707L | Socket, 1/4" DR 7/32" 6 PT Deep |
| J4708L | Socket, 1/4" DR 1/4" 6 PT Deep |
| J4709L | Socket, 1/4" DR 9/32" 6 PT Deep |
| J4710L | Socket, 1/4" DR 5/16" 6 PT Deep |
| J4711L | Socket, 1/4" DR 11/32" 6 PT Deep |
| J4712L | Socket, 1/4" DR 3/8" 6 PT Deep |
| J4714L | Socket, 1/4" DR 7/16" 6 PT Deep |
| J4716L | Socket, 1/4" DR 1/2" 6 PT Deep |
| J4718 | Socket, 1/4" DR 9/16" 6 PT |
| J4718L | Socket, 1/4" DR 9/16" 6 PT Deep |
| J5412 | Socket, 1/2" DR 3/8" 12 PT |
| J5414 | Socket, 1/2" DR 7/16" 12 PT |
| J5416 | Socket, 1/2" DR 1/2" 12 PT |
| J5418 | Socket, 1/2" DR 9/16" 12 PT |
| J5420 | Socket, 1/2" DR 5/8" 12 PT |
| J5422 | Socket, 1/2" DR 11/16" 12 PT |
| J5424 | Socket, 1/2" DR 3/4" 12 PT |
| J5426 | Socket, 1/2" DR 13/16" 12 PT |
| J5428 | Socket, 1/2" DR 7/8" 12 PT |
| J5430 | Socket, 1/2" DR 15/16" 12 PT |
| J5432 | Socket, 1/2" DR 1" 12 PT |
| J5434 | Socket, 1/2" DR 1-1/16" 12 PT |
| J5436 | Socket, 1/2" DR 1-1/8" 12 PT |
| J5440 | Socket, 1/2" DR 1-1/4" 12 PT |
| J5316 | Socket, 1/2" DR 1/2" 12 PT Deep |
| J5318 | Socket, 1/2" DR 9/16" 12 PT Deep |
| J5320 | Socket, 1/2" DR 5/8" 12 PT Deep |
| J5322 | Socket, 1/2" DR 11/16" 12 PT Deep |
| J5324 | Socket, 1/2" DR 3/4" 12 PT Deep |
| J5326 | Socket, 1/2" DR 13/16" 12 PT Deep |
| J5328 | Socket, 1/2" DR 7/8" 12 PT Deep |
| J5330 | Socket, 1/2" DR 15/16" 12 PT Deep |
| J5332 | Socket, 1/2" DR 1" 12 PT Deep |
| J5334 | Socket, 1/2" DR 1-1/16" 12 PT Deep |
| J5336 | Socket, 1/2" DR 1-1/8" 12 PT Deep |
| J5340 | Socket, 1/2" DR 1-1/4" 12 PT Deep |
| J5528 | Socket, 3/4" DR 7/8" 12 PT |
| J5530 | Socket, 3/4" DR 15/16" 12 PT |
| J5532 | Socket, 3/4" DR 1" 12 PT |
| J5534 | Socket, 3/4" DR 1-1/16" 12 PT |
| J5536 | Socket, 3/4" DR 1-1/8" 12 PT |
| J5540 | Socket, 3/4" DR 1-1/4" 12 PT |
| J5544 | Socket, 3/4" DR 1-3/8" 12 PT |
| J5546 | Socket, 3/4" DR 1-7/16" 12 PT |
| J5548 | Socket, 3/4" DR 1-1/2" 12 PT |
| J5556 | Socket, 3/4" DR 1-3/4" 12 PT |
| J5542 | Socket, 3/4" DR 1-5/16" 12 PT |
| J5552 | Socket, 3/4" DR 1-5/8" 12 PT |
| J5558 | Socket, 3/4" DR 1-13/16" 12 PT |
| J5560 | Socket, 3/4" DR 1-7/8" 12 PT |
| J5564 | Socket, 3/4" DR 2" 12 PT |

(CONTINUED ON NEXT PAGE)

272 PC MASTER TOOL SET (CONTINUED)

Product #: **J99710**



| Contents | Description | Contents | Description |
|-----------|---|----------|--|
| J5210S | Socket, 3/8" DR 5/16" 8 PT | J1131 | Wrench, Box 5/8" x 3/4" 12 PT Short |
| J5212S | Socket, 3/8" DR 3/8" 8 PT | J801 | Wrench, Chain |
| J5208S | Socket, 3/8" DR 1/4" 8 PT | J1210A | Wrench, Combination 5/16" 12 PT |
| J5212 | Socket, 3/8" DR 3/8" 12 PT | J1212ASD | Wrench, Combination 3/8" 12 PT |
| J5214 | Socket, 3/8" DR 7/16" 12 PT | J1214ASD | Wrench, Combination 7/16" 12 PT |
| J5216 | Socket, 3/8" DR 1/2" 12 PT | J1216ASD | Wrench, Combination 1/2" 12 PT |
| J5218 | Socket, 3/8" DR 9/16" 12 PT | J1218ASD | Wrench, Combination 9/16" 12 PT |
| J5220 | Socket, 3/8" DR 5/8" 12 PT | J1220ASD | Wrench, Combination 5/8" 12 PT |
| J5222 | Socket, 3/8" DR 11/16" 12 PT | J1222ASD | Wrench, Combination 11/16" 12 PT |
| J5224 | Socket, 3/8" DR 3/4" 12 PT | J1224ASD | Wrench, Combination 3/4" 12 PT |
| J5226 | Socket, 3/8" DR 13/16" 12 PT | J1226ASD | Wrench, Combination 13/16" 12 PT |
| J5228 | Socket, 3/8" DR 7/8" 12 PT | J1228ASD | Wrench, Combination 7/8" 12 PT |
| J5012 | Socket, 3/8" DR 3/8" 12 PT Deep | J1230ASD | Wrench, Combination 15/16" 12 PT |
| J5014 | Socket, 3/8" DR 7/16" 12 PT Deep | J1232ASD | Wrench, Combination 1" 12 PT |
| J5016 | Socket, 3/8" DR 1/2" 12 PT Deep | J1234ASD | Wrench, Combination 1-1/16" 12 PT |
| J5018 | Socket, 3/8" DR 9/16" 12 PT Deep | J1236ASD | Wrench, Combination 1-1/8" 12 PT |
| J5020 | Socket, 3/8" DR 5/8" 12 PT Deep | J1240ASD | Wrench, Combination 1-1/4" 12 PT |
| J5022 | Socket, 3/8" DR 11/16" 12 PT Deep | J1242 | Wrench, Combination 1-5/16" 12 PT |
| J5024 | Socket, 3/8" DR 3/4" 12 PT Deep | J1244 | Wrench, Combination 1-3/8" 12 PT |
| J5026 | Socket, 3/8" DR 13/16" 12 PT Deep | J1246 | Wrench, Combination 1-7/16" 12 PT |
| J5028 | Socket, 3/8" DR 7/8" 12 PT Deep | J1248 | Wrench, Combination 1-1/2" 12 PT |
| J49901/8 | Socket, Hex Bit 3/8" DR 1/8" | J3751 | Wrench, Flare Nut Combination 3/8" 6 PT |
| J49905/32 | Socket, Hex Bit 3/8" DR 5/32" | J3752 | Wrench, Flare Nut Combination 7/16" 6 PT |
| J49903/16 | Socket, Hex Bit 3/8" DR 3/16" | J3753 | Wrench, Flare Nut Combination 1/2" 6 PT |
| J49907/32 | Socket, Hex Bit 3/8" DR 7/32" | J3754 | Wrench, Flare Nut Combination 9/16" 6 PT |
| J49901/4 | Socket, Hex Bit 3/8" DR 1/4" | J3755 | Wrench, Flare Nut Combination 5/8" 6 PT |
| J49905/16 | Socket, Hex Bit 3/8" DR 5/16" | J3756 | Wrench, Flare Nut Combination 11/16" 6 PT |
| J49903/8 | Socket, Hex Bit 3/8" DR 3/8" | J3757 | Wrench, Flare Nut Combination 3/4" 6 PT |
| J54411/2 | Socket, Hex Bit 1/2" DR 1/2" | J3018 | Wrench, Open End 1/4" x 5/16" |
| J54419/16 | Socket, Hex Bit 1/2" DR 9/16" | J3020 | Wrench, Open End 3/8" x 5/16" |
| J54415/8 | Socket, Hex Bit 1/2" DR 5/8" | J3025 | Wrench, Open End 7/16" x 1/2" |
| J5274A | Socket, Universal 3/8" DR 7/16" 12 PT | J3026 | Wrench, Open End 1/2" x 9/16" |
| J5275A | Socket, Universal 3/8" DR 1/2" 12 PT | J3030 | Wrench, Open End 9/16" x 5/8" |
| J5276A | Socket, Universal 3/8" DR 9/16" 12 PT | J3031 | Wrench, Open End 5/8" x 3/4" |
| J5277A | Socket, Universal 3/8" DR 5/8" 12 PT | J3035 | Wrench, Open End 11/16" x 3/4" |
| J5279A | Socket, Universal 3/8" DR 3/4" 12 PT | J3040 | Wrench, Open End 13/16" x 7/8" |
| 33-212 | Tape Rule, Stanley® Powerlock® with Metal Case 1/2" x 12' | J3045 | Wrench, Open End 15/16" x 1" |
| J6014C | Wrench, Torque 1/2" DR 50-250 ft-lbs | J3050 | Wrench, Open End 1-1/16" x 1-1/8" |
| J706 | Wrench, Adjustable 6" | J810HD | Wrench, Pipe Heavy-Duty 10" |
| J708 | Wrench, Adjustable 8" | J814HD | Wrench, Pipe Heavy-Duty 14" |
| J710 | Wrench, Adjustable 10" | J818HD | Wrench, Pipe Heavy-Duty 18" |
| J712 | Wrench, Adjustable 12" | J1191T-A | Wrench, Ratcheting Box 1/4" x 5/16" 12 PT |
| J1120 | Wrench, Box 5/16" x 3/8" 12 PT Short | J1192T-A | Wrench, Ratcheting Box 3/8" x 7/16" 12 PT |
| J1122 | Wrench, Box 3/8" x 7/16" 12 PT Short | J1193T-A | Wrench, Ratcheting Box 1/2" x 9/16" 12 PT |
| J1126 | Wrench, Box 1/2" x 9/16" 12 PT Short | J1194-A | Wrench, Ratcheting Box 5/8" x 11/16" 12 PT |
| | | J1195-A | Wrench, Ratcheting Box 3/4" x 7/8" 12 PT |



272 PC MASTER SET WITH ROLLER CABINET J442742-8RD

Product #: J99711



- › 272 Pieces.
- › 1/4", 3/8", 1/2", 3/4" Drive Tools.
- › Designed for fastener sizes 3/16" - 2".
- › Contains: 122 Sockets and Accessories, 54 Wrenches, 17 Striking and Struck Tools, 26 Pliers, 19 Screwdrivers, 34 Miscellaneous Tools.
- › Weight: 403.0 lbs.



Representative Image; Contents May Differ

272 PC MASTER SET WITH ROLLER CABINET J453441-8RD

Product #: J99712



- › 272 Pieces.
- › 1/4", 3/8", 1/2", 3/4" Drive Tools.
- › Designed for fastener sizes 3/16" - 2".
- › Contains: 122 Sockets and Accessories, 54 Wrenches, 17 Striking and Struck Tools, 26 Pliers, 19 Screwdrivers, 34 Miscellaneous Tools.
- › Weight: 525.0 lbs.



Representative Image; Contents May Differ

Made in USA accurate at time of printing, consult www.protoindustrial.com for updated information.



Made in USA



Made in USA with global components



194 PC MASTER SET

Product #: J99530



- › 194 Pieces.
- › 1/4", 3/8", 1/2" Drive Tools.
- › Designed for fastener sizes 1/8" - 1-1/4".
- › Tools only.
- › Contains: 109 Sockets and Accessories, 60 Wrenches, 11 Screwdrivers, 1 Pliers, 13 Miscellaneous Tools.
- › Weight: 61.0 lbs.



Representative Image; Contents May Differ





| Contents | Description |
|-----------------|------------------------------------|
| J5496-NA | Box, 19" Set |
| J4770A | Adapter, Universal Joint 1/4" DR |
| J5270A | Adapter, Universal Joint 3/8" DR |
| J5470A | Adapter, Universal Joint 1/2" DR |
| J4769 | Driver, 1/4" DR |
| J4759 | Extension, 1/4" DR 2" |
| J4761 | Extension, 1/4" DR 6" |
| J5260 | Extension, 3/8" DR 3" |
| J5260-06 | Extension, 3/8" DR 6" |
| J5262 | Extension, 3/8" DR 12" |
| J5460 | Extension, 1/2" DR 2-1/2" |
| J5461 | Extension, 1/2" DR 5" |
| J5463 | Extension, 1/2" DR 10" |
| J5265 | Handle, Hinge 3/8" DR 8-1/2" |
| J5468 | Handle, Hinge 1/2" DR |
| J5280G | Handle, Speed 3/8" DR |
| J5480G | Handle, Speed 1/2" DR |
| J4980 | Hex Key, 13 PC Standard Set |
| J9206 | Nut Driver, 3/16" |
| J9207 | Nut Driver, 7/32" |
| J9208 | Nut Driver, 1/4" |
| J9209 | Nut Driver, 9/32" |
| J9210 | Nut Driver, 5/16" |
| J9211 | Nut Driver, 11/32" |
| J9212 | Nut Driver, 3/8" |
| J9214 | Nut Driver 7/16" |
| J9218 | Nut Driver, 9/16" |
| J9216 | Nut Driver, 1/2" |
| J9220 | Nut Driver, 5/8" |
| J235 | Pliers, Ignition with Grip 4-1/16" |
| J4749 | Ratchet, 1/4" DR |
| J5249 | Ratchet, 3/8" DR |
| J5449 | Ratchet, 1/2" DR |
| J4706T | Socket, 1/4" DR 3/16" 12 PT |
| J4708T | Socket, 1/4" DR 1/4" 12 PT |
| J4707T | Socket, 1/4" DR 7/32" 12 PT |
| J4709T | Socket, 1/4" DR 9/32" 12 PT |
| J4710T | Socket, 1/4" DR 5/16" 12 PT |
| J4711T | Socket, 1/4" DR 11/32" 12 PT |
| J4712T | Socket, 1/4" DR 3/8" 12 PT |
| J4714T | Socket, 1/4" DR 7/16" 12 PT |
| J4716T | Socket, 1/4" DR 1/2" 12 PT |
| J4718T | Socket, 1/4" DR 9/16" 12 PT |
| J4706LT | Socket, 1/4" DR 3/16" 12 PT Deep |
| J4708LT | Socket, 1/4" DR 1/4" 12 PT Deep |
| J4707LT | Socket, 1/4" DR 7/32" 12 PT Deep |
| J4709LT | Socket, 1/4" DR 9/32" 12 PT Deep |
| J4710LT | Socket, 1/4" DR 5/16" 12 PT Deep |
| J4711LT | Socket, 1/4" DR 11/32" 12 PT Deep |
| J4712LT | Socket, 1/4" DR 3/8" 12 PT Deep |
| J4714LT | Socket, 1/4" DR 7/16" 12 PT Deep |
| J4716LT | Socket, 1/4" DR 1/2" 12 PT Deep |
| J4718LT | Socket, 1/4" DR 9/16" 12 PT Deep |
| J5208S | Socket, 3/8" DR 1/4" 8 PT |
| J5210S | Socket, 3/8" DR 5/16" 8 PT |
| J5212S | Socket, 3/8" DR 3/8" 8 PT |
| J5212 | Socket, 3/8" DR 3/8" 12 PT |
| J5214 | Socket, 3/8" DR 7/16" 12 PT |

| Contents | Description |
|-----------------|------------------------------------|
| J5216 | Socket, 3/8" DR 1/2" 12 PT |
| J5218 | Socket, 3/8" DR 9/16" 12 PT |
| J5220 | Socket, 3/8" DR 5/8" 12 PT |
| J5222 | Socket, 3/8" DR 11/16" 12 PT |
| J5224 | Socket, 3/8" DR 3/4" 12 PT |
| J5226 | Socket, 3/8" DR 13/16" 12 PT |
| J5228 | Socket, 3/8" DR 7/8" 12 PT |
| J5012 | Socket, 3/8" DR 3/8" 12 PT Deep |
| J5014 | Socket, 3/8" DR 7/16" 12 PT Deep |
| J5016 | Socket, 3/8" DR 1/2" 12 PT Deep |
| J5018 | Socket, 3/8" DR 9/16" 12 PT Deep |
| J5020 | Socket, 3/8" DR 5/8" 12 PT Deep |
| J5022 | Socket, 3/8" DR 11/16" 12 PT Deep |
| J5024 | Socket, 3/8" DR 3/4" 12 PT Deep |
| J5026 | Socket, 3/8" DR 13/16" 12 PT Deep |
| J5028 | Socket, 3/8" DR 7/8" 12 PT Deep |
| J5412 | Socket, 1/2" DR 3/8" 12 PT |
| J5414 | Socket, 1/2" DR 7/16" 12 PT |
| J5416 | Socket, 1/2" DR 1/2" 12 PT |
| J5418 | Socket, 1/2" DR 9/16" 12 PT |
| J5419 | Socket, 1/2" DR 19/32" 12 PT |
| J5420 | Socket, 1/2" DR 5/8" 12 PT |
| J5421 | Socket, 1/2" DR 21/32" 12 PT |
| J5422 | Socket, 1/2" DR 11/16" 12 PT |
| J5424 | Socket, 1/2" DR 3/4" 12 PT |
| J5425 | Socket, 1/2" DR 25/32" 12 PT |
| J5426 | Socket, 1/2" DR 13/16" 12 PT |
| J5428 | Socket, 1/2" DR 7/8" 12 PT |
| J5430 | Socket, 1/2" DR 15/16" 12 PT |
| J5431 | Socket, 1/2" DR 31/32" 12 PT |
| J5432 | Socket, 1/2" DR 1" 12 PT |
| J5434 | Socket, 1/2" DR 1-1/16" 12 PT |
| J5436 | Socket, 1/2" DR 1-1/8" 12 PT |
| J5438 | Socket, 1/2" DR 1-3/16" 12 PT |
| J5440 | Socket, 1/2" DR 1-1/4" 12 PT |
| J5312 | Socket, 1/2" DR 3/8" 12 PT Deep |
| J5314 | Socket, 1/2" DR 7/16" 12 PT Deep |
| J5316 | Socket, 1/2" DR 1/2" 12 PT Deep |
| J5318 | Socket, 1/2" DR 9/16" 12 PT Deep |
| J5320 | Socket, 1/2" DR 5/8" 12 PT Deep |
| J5322 | Socket, 1/2" DR 11/16" 12 PT Deep |
| J5324 | Socket, 1/2" DR 3/4" 12 PT Deep |
| J5326 | Socket, 1/2" DR 13/16" 12 PT Deep |
| J5328 | Socket, 1/2" DR 7/8" 12 PT Deep |
| J5330 | Socket, 1/2" DR 15/16" 12 PT Deep |
| J5332 | Socket, 1/2" DR 1" 12 PT Deep |
| J5334 | Socket, 1/2" DR 1-1/16" 12 PT Deep |
| J5336 | Socket, 1/2" DR 1-1/8" 12 PT Deep |
| J5338 | Socket, 1/2" DR 1-3/16" 12 PT Deep |
| J5340 | Socket, 1/2" DR 1-1/4" 12 PT Deep |
| J49901/8 | Socket, Hex Bit 3/8" DR 1/8" |
| J49905/32 | Socket, Hex Bit 3/8" DR 5/32" |
| J49903/16 | Socket, Hex Bit 3/8" DR 3/16" |
| J49907/32 | Socket, Hex Bit 3/8" DR 7/32" |
| J49901/4 | Socket, Hex Bit 3/8" DR 1/4" |
| J49905/16 | Socket, Hex Bit 3/8" DR 5/16" |
| J49903/8 | Socket, Hex Bit 3/8" DR 3/8" |
| J54411/2 | Socket, Hex Bit 1/2" DR 1/2" |

(CONTINUED ON NEXT PAGE)

194 PC MASTER SET (CONTINUED)

Product #: **J99530**



| Contents | Description |
|-----------|---------------------------------------|
| J54419/16 | Socket, Hex Bit 1/2" DR 9/16" |
| J54415/8 | Socket, Hex Bit 1/2" DR 5/8" |
| J5274A | Socket, Universal 3/8" DR 7/16" 12 PT |
| J5275A | Socket, Universal 3/8" DR 1/2" 12 PT |
| J5276A | Socket, Universal 3/8" DR 9/16" 12 PT |
| J5277A | Socket, Universal 3/8" DR 5/8" 12 PT |
| J5279A | Socket, Universal 3/8" DR 3/4" 12 PT |
| J708 | Wrench, Adjustable 8" |
| J710 | Wrench, Adjustable 10" |
| J712 | Wrench, Adjustable 12" |
| J3210 | Wrench, Angle 13/64" x 15/64" Short |
| J3215 | Wrench, Angle 7/32" x 1/4" Short |
| J3211 | Wrench, Angle 15/64" x 13/64" Short |
| J3216 | Wrench, Angle 1/4" x 7/32" Short |
| J3220 | Wrench, Angle 9/32" x 5/16" Short |
| J3221 | Wrench, Angle 5/16" x 9/32" Short |
| J3225 | Wrench, Angle 11/32" x 3/8" Short |
| J3226 | Wrench, Angle 3/8" x 11/32" Short |
| J1120 | Wrench, Box 5/16" x 3/8" 12 PT Short |
| J1122 | Wrench, Box 3/8" x 7/16" 12 PT Short |
| J1126 | Wrench, Box 1/2" x 9/16" 12 PT Short |
| J1131 | Wrench, Box 5/8" x 3/4" 12 PT Short |
| J1210A | Wrench, Combination 5/16" 12 PT |
| J1212ASD | Wrench, Combination 3/8" 12 PT |
| J1214ASD | Wrench, Combination 7/16" 12 PT |
| J1216ASD | Wrench, Combination 1/2" 12 PT |
| J1218ASD | Wrench, Combination 9/16" 12 PT |
| J1220ASD | Wrench, Combination 5/8" 12 PT |
| J1222ASD | Wrench, Combination 11/16" 12 PT |
| J1224ASD | Wrench, Combination 3/4" 12 PT |
| J1226ASD | Wrench, Combination 13/16" 12 PT |
| J1228ASD | Wrench, Combination 7/8" 12 PT |
| J1230ASD | Wrench, Combination 15/16" 12 PT |
| J1232ASD | Wrench, Combination 1" 12 PT |

| Contents | Description |
|----------|--|
| J1234ASD | Wrench, Combination 1-1/16" 12 PT |
| J1236ASD | Wrench, Combination 1-1/8" 12 PT |
| J1240ASD | Wrench, Combination 1-1/4" 12 PT |
| J1204EF | Wrench, Combination 1/8" 6 PT Short |
| J1205EF | Wrench, Combination 5/32" 6 PT Short |
| J1206EF | Wrench, Combination 3/16" 6 PT Short |
| J1208EF | Wrench, Combination 1/4" 6 PT Short |
| J1209EF | Wrench, Combination 9/32" 6 PT Short |
| J1210EF | Wrench, Combination 5/16" 6 PT Short |
| J1211EF | Wrench, Combination 11/32" 6 PT Short |
| J1212EF | Wrench, Combination 3/8" 6 PT Short |
| J3751 | Wrench, Flare Nut Combination 3/8" 6 PT |
| J3752 | Wrench, Flare Nut Combination 7/16" 6 PT |
| J3753 | Wrench, Flare Nut Combination 1/2" 6 PT |
| J3754 | Wrench, Flare Nut Combination 9/16" 6 PT |
| J3755 | Wrench, Flare Nut Combination 5/8" 6 PT |
| J3756 | Wrench, Flare Nut Combination 11/16" 6 PT |
| J3757 | Wrench, Flare Nut Combination 3/4" 6 PT |
| J1725 | Wrench, Obstruction 7/16" x 1/2" |
| J1730 | Wrench, Obstruction 9/16" x 5/8" |
| J1731 | Wrench, Obstruction 5/8" x 3/4" |
| J1191T-A | Wrench, Ratcheting Box 1/4" x 5/16" 12 PT |
| J1192T-A | Wrench, Ratcheting Box 3/8" x 7/16" 12 PT |
| J1193T-A | Wrench, Ratcheting Box 1/2" x 9/16" 12 PT |
| J1194-A | Wrench, Ratcheting Box 5/8" x 11/16" 12 PT |
| J1195-A | Wrench, Ratcheting Box 3/4" x 7/8" 12 PT |
| J1270-12 | Wrench, Swivel Combination 3/8" 12 PT |
| J1270-14 | Wrench, Swivel Combination 7/16" 12 PT |
| J1270-16 | Wrench, Swivel Combination 1/2" 12 PT |
| J1270-18 | Wrench, Swivel Combination 9/16" 12 PT |
| J1270-20 | Wrench, Swivel Combination 5/8" 12 PT |
| J1270-22 | Wrench, Swivel Combination 11/16" 12 PT |
| J1270-24 | Wrench, Swivel Combination 3/4" 12 PT |



194 PC MASTER SET WITH TOP CHEST J442719-10RD-D

Product #: J99531



- › 194 Pieces.
- › 1/4", 3/8", 1/2" Drive Tools.
- › Designed for fastener sizes 1/8" - 1-1/4".
- › Tools only.
- › Contains: 109 Sockets and Accessories, 61 Wrenches, 11 Screwdrivers, 13 Miscellaneous Tools.
- › Weight: 208.0 lbs.



Representative Image; Contents May Differ

194 PC MASTER SET WITH TOP CHEST J442719-8RD

Product #: J99532



- › 194 Pieces.
- › 1/4", 3/8", 1/2" Drive Tools.
- › Designed for fastener sizes 1/8" - 1-1/4".
- › Tools only.
- › Contains: 109 Sockets and Accessories, 61 Wrenches, 11 Screwdrivers, 13 Miscellaneous Tools.
- › Weight: 206.0 lbs.



Representative Image; Contents May Differ



558 PC METRIC MASTER SET



Product #: **JCS-0558MAS**

- › 558 Pieces.
- › 1/4", 3/8", 1/2" Drive Tools.
- › Designed for fastener sizes 1/4" - 1-1/2", 2 mm - 36 mm.
- › Tools only.
- › Contains: 282 Sockets and Accessories, 122 Wrenches, 32 Striking and Struck Tools, 38 Pliers, 43 Screwdrivers, 41 Miscellaneous Tools.
- › Enhanced version of Proto® J99560 Metric Master Set.
- › Weight: 223.0 lbs.



Representative Image; Contents May Differ



| Contents | Description |
|-----------------|---|
| J4770A | Adapter, Universal Joint 1/4" DR |
| J5270A | Adapter, Universal Joint 3/8" DR |
| J5470A | Adapter, Universal Joint 1/2" DR |
| J2126 | Bar, 12" Long 1/2" Tip |
| J2130 | Bar, 16" Long 5/8" Tip |
| J2120 | Bar, Pry Aligning 18" |
| J2124 | Bar, Pry Aligning 24" |
| J404 | C-Clamps, Capacity 0"-4", 2 Each |
| J86A3/16 | Chisel, Cold 1/4" |
| J86A1/4 | Chisel, Cold 5/16" |
| J86A5/16 | Chisel, Cold 3/8" |
| J86A7/16 | Chisel, Cold 1/2" |
| J86A1/2 | Chisel, Cold 5/8" |
| J86A5/8 | Chisel, Cold 3/4" |
| J86A3/4X8 | Chisel, Cold 7/8" |
| J86A7/8X8 | Chisel, Cold 1" |
| J86A1X8 | Chisel, Cold 1-3/16" |
| J4769 | Driver, 1/4" DR |
| J9521 | Extractor, Screw 1/8" |
| J9522 | Extractor, Screw 3/16" |
| J9523 | Extractor, Screw 15/64" |
| J9524 | Extractor, Screw 5/16" |
| J9525 | Extractor, Screw 3/8" |
| J9525B | Extractor, Screw 15/32" |
| J9526 | Extractor, Screw 9/16" |
| J9527 | Extractor, Screw 21/32" |
| J9528 | Extractor, Screw 13/16" |
| J9529 | Extractor, Screw 1-1/16" |
| J4759 | Extension, 1/4" DR 2" |
| J4761 | Extension, 1/4" DR 6" |
| J5260 | Extension, 3/8" DR 3" |
| J5260-06 | Extension, 3/8" DR 6" |
| J5262 | Extension, 3/8" DR 12" |
| J5460 | Extension, 1/2" DR 2-1/2" |
| J5461 | Extension, 1/2" DR 5" |
| J5463 | Extension, 1/2" DR 10" |
| J5268 | Extension, Flex 3/8" DR 8" |
| J5260W | Extension, Wobble 3/8" DR 3" |
| J5260-06W | Extension, Wobble 3/8" DR 6" |
| J95218 | Knife, Folding Blade |
| J1308PD | Hammer, Ball Pein 8 oz. |
| J1316PD | Hammer, Ball Pein 16 oz. |
| J1332PD | Hammer, Ball Pein 32 oz. |
| 57-532 | Hammer, Compo-Cast® 21 oz. |
| J4766 | Handle, Hinge 1/4" DR 5-3/4" |
| J5265 | Handle, Hinge 3/8" DR 8-1/2" |
| J5468 | Handle, Hinge 1/2" DR |
| J5285 | Handle, Sliding T 3/8" DR |
| J5485 | Handle, Sliding T 1/2" DR |
| J4780G | Handle, Speed 1/4" DR |
| J5280G | Handle, Speed 3/8" DR |
| J5480G | Handle, Speed 1/2" DR |
| 20-001 | Stanley® Hacksaw, High Tension Low Profile 12" |
| J4984 | Hex Key, 9 PC Metric Set |
| J2108 | Holder, Punch and Chisel |
| J18545B | Knife, Lockback 5" |
| 10-099 | Knife, Stanley® Classic 99® Retractable Blade Utility |
| J1368 | Mallet, Rubber |

| Contents | Description |
|-----------------|--|
| J2373 | Mirror, Rectangular Telescoping 2-1/8" |
| J9207 | Nut Driver, 7/32" |
| J9208 | Nut Driver, 1/4" |
| J9206 | Nut Driver, 3/16" |
| J9209 | Nut Driver, 9/32" |
| J9210 | Nut Driver, 5/16" |
| J9211 | Nut Driver, 11/32" |
| J9212 | Nut Driver, 3/8" |
| J9214 | Nut Driver 7/16" |
| J9216 | Nut Driver, 1/2" |
| J9218 | Nut Driver, 9/16" |
| J9220 | Nut Driver, 5/8" |
| J9204M | Nut Driver, 4 mm |
| J9205M | Nut Driver, 5 mm |
| J92055M | Nut Driver, 5.5 mm |
| J9206M | Nut Driver, 6 mm |
| J9207M | Nut Driver, 7 mm |
| J9208M | Nut Driver, 8 mm |
| J9209M | Nut Driver, 9 mm |
| J9210M | Nut Driver, 10 mm |
| J9211M | Nut Driver, 11 mm |
| J9213M | Nut Driver, 13 mm |
| J9214M | Nut Driver, 14 mm |
| J2806SMP | Pliers, 6 PC Mini Set |
| J206G | Pliers, Diagonal Cutting with Grip 6-1/16" |
| J209G | Pliers, Diagonal Cutting with Grip 7-5/16" |
| J227G | Pliers, Duckbill with Grip 7-25/32" |
| J272G | Pliers, End Cutting High Leverage 8-1/4" |
| J268G | Pliers, Lineman's with Grip 8-5/8" |
| J292NC | Pliers, Locking Curved 10" |
| J286LNXL | Pliers, Locking Mini Long Nose 6-29/32" |
| J291NC | Pliers, Locking Straight 7" |
| J225G | Pliers, Needle-Nose Bent Nose 6-5/16" |
| J222G | Pliers, Needle-Nose Long Thin 6-1/16" |
| J226G | Pliers, Needle-Nose with Cutter 6-5/8" |
| J360B | Pliers, 12 PC Set Convertible Retaining Ring |
| J276G | Pliers, Slip-Joint with Grip 6-9/16" |
| J278G | Pliers, Slip-Joint with Grip 8-1/16" |
| J261SG | Pliers, Tongue and Groove 5" with Grip |
| J262SG | Pliers, Tongue and Groove 6-1/2" with Grip |
| J260SG | Pliers, Tongue and Groove 10-3/16" with Grip |
| J298 | Pliers, Wire Strippers 8-1/4" |
| J2375 | Retrieval Tool, Pocket Magnetic |
| J2306 | Puller, Cotter Pin Tool |
| J4056-4 | Puller, Jaw Reversible 4 R |
| J4250N | Puller, Nut Adjustable Reversible |
| J4056PN | Puller, Pin Pivot |
| J4205S | Puller, Screw Forcing Acme |
| J4022T | Puller, Tip Detachable Standard |
| J4255B | Puller, Yoke 3 Way Jaw ACM |
| J413/8 | Punch, Center 3/8" |
| J411/2 | Punch, Center 1/2" |
| J965/16 | Punch, Drift 1/8" |
| J963/8 | Punch, Drift 3/16" |
| J961/2 | Punch, Drift 1/4" |
| J471/4X3/32 | Punch, Pin 3/32" |
| J475/16X1/8 | Punch, Pin 1/8" |
| J475/16X5/32 | Punch, Pin 5/32" |

(CONTINUED ON NEXT PAGE)

558 PC METRIC MASTER SET (CONTINUED)



Product #: JCS-0558MAS

| Contents | Description | Contents | Description |
|--------------|--|----------|---|
| J473/8X3/16 | Punch, Pin 3/16" | J4704M | Socket, 1/4" DR 4 mm 6 PT |
| J477/16X7/32 | Punch, Pin 7/32" | J4705M | Socket, 1/4" DR 5 mm 6 PT |
| J471/2X1/4 | Punch, Pin 1/4" | J47055M | Socket, 1/4" DR 5.5 mm 6 PT |
| J445/16 | Punch, Prick 5/16" | J4706M | Socket, 1/4" DR 6 mm 6 PT |
| J501/4 | Punch, Starting 3/32" | J4707M | Socket, 1/4" DR 7 mm 6 PT |
| J505/16 | Punch, Starting 1/8" | J4708M | Socket, 1/4" DR 8 mm 6 PT |
| J503/8 | Punch, Starting 3/16" | J4709M | Socket, 1/4" DR 9 mm 6 PT |
| J507/16 | Punch, Starting 7/32" | J4710M | Socket, 1/4" DR 10 mm 6 PT |
| J501/2 | Punch, Starting 1/4" | J4711M | Socket, 1/4" DR 11 mm 6 PT |
| J4749XL | Ratchet, 1/4" DR Standard Length Premium Pear Head | J4712M | Socket, 1/4" DR 12 mm 6 PT |
| J5249XL | Ratchet, 3/8" DR Standard Length Premium Pear Head | J4713M | Socket, 1/4" DR 13 mm 6 PT |
| J5449XL | Ratchet, 1/2" DR Standard Length Premium Pear Head | J4714M | Socket, 1/4" DR 14 mm 6 PT |
| J5450 | Ratchet, 1/2" DR (Long Handle) | J4706L | Socket, 1/4" DR 3/16" 6 PT Deep |
| J5247 | Ratchet, Adapter 3/8" DR 5/16" | J4707L | Socket, 1/4" DR 7/32" 6 PT Deep |
| J5257F | Ratchet, 3/8" DR Flex-Head 2-1/16" | J4708L | Socket, 1/4" DR 1/4" 6 PT Deep |
| J5457F | Ratchet, 1/2" DR Flex-Head 17-3/32" | J4709L | Socket, 1/4" DR 9/32" 6 PT Deep |
| 28-540 | Scraper, Flexible 1-1/4" Wood Handle | J4710L | Socket, 1/4" DR 5/16" 6 PT Deep |
| 28-240 | Scraper, Flexible Nylon 1-1/4" | J4711L | Socket, 1/4" DR 11/32" 6 PT Deep |
| J2336 | Scrapers, Gasket and Carbon | J4712L | Socket, 1/4" DR 3/8" 6 PT Deep |
| J9884 | Screw Starter, Phillips® Tip | J4714L | Socket, 1/4" DR 7/16" 6 PT Deep |
| J9853 | Screw Starter, Standard Tip | J4716L | Socket, 1/4" DR 1/2" 6 PT Deep |
| J88203 | Screwdriver, Slotted Cabinet, Round 1/8" x 3" | J4718L | Socket, 1/4" DR 9/16" 6 PT Deep |
| J88204 | Screwdriver, Slotted Cabinet, Round 1/8" x 4" | J4704LM | Socket, 1/4" DR 4 mm 6 PT Deep |
| J88208 | Screwdriver, Slotted Cabinet, Round 1/8" x 8" | J4705LM | Socket, 1/4" DR 5 mm 6 PT Deep |
| J88214 | Screwdriver, Slotted Cabinet, Round 3/16" x 4" | J47055LM | Socket, 1/4" DR 5.5 mm 6 PT Deep |
| J88218 | Screwdriver, Slotted Cabinet, Round 3/16" x 8" | J4706LM | Socket, 1/4" DR 6 mm 6 PT Deep |
| J88393 | Screwdriver, Phillips® #0 | J4707LM | Socket, 1/4" DR 7 mm 6 PT Deep |
| J88313 | Screwdriver, Phillips® #1 | J4708LM | Socket, 1/4" DR 8 mm 6 PT Deep |
| J88318 | Screwdriver, Phillips® #1 | J4709LM | Socket, 1/4" DR 9 mm 6 PT Deep |
| J88324 | Screwdriver, Phillips® #2 | J4710LM | Socket, 1/4" DR 10 mm 6 PT Deep |
| J88328 | Screwdriver, Phillips® #2 | J4711LM | Socket, 1/4" DR 11 mm 6 PT Deep |
| J88322 | Screwdriver, Phillips® #2 | J4712LM | Socket, 1/4" DR 12 mm 6 PT Deep |
| J88336 | Screwdriver, Phillips® #3 | J4713LM | Socket, 1/4" DR 13 mm 6 PT Deep |
| J88348 | Screwdriver, Phillips® #4 | J4714LM | Socket, 1/4" DR 14 mm 6 PT Deep |
| J88102 | Screwdriver, Slotted Keystone, Square 1/4" x 2" | J5206HS | Socket, 3/8" DR 3/16" 6 PT Super Short |
| J88104 | Screwdriver, Slotted Keystone, Square 1/4" x 4" | J5208HS | Socket, 3/8" DR 1/4" 6 PT Super Short |
| J88106 | Screwdriver, Slotted Keystone, Square 1/4" x 6" | J5210HS | Socket, 3/8" DR 5/16" 6 PT Super Short |
| J88108 | Screwdriver, Slotted Keystone, Square 1/4" x 8" | J5212HS | Socket, 3/8" DR 3/8" 6 PT Super Short |
| J88112 | Screwdriver, Slotted Keystone, Square 1/4" x 12" | J5214HS | Socket, 3/8" DR 7/16" 6 PT Super Short |
| J88002 | Screwdriver, Slotted Keystone, Round 1/4" x 1-1/2" | J5216HS | Socket, 3/8" DR 1/2" 6 PT Super Short |
| J4981 | Set, Hex Key 11 PC | J5218HS | Socket, 3/8" DR 9/16" 6 PT Super Short |
| J322 | Snips, Straight 12-3/4" | J5224HS | Socket, 3/8" DR 3/4" 6 PT Super Short |
| J303S | Snips, Aviation Straight | J5222HS | Socket, 3/8" DR 11/16" 6 PT Super Short |
| J308 | Snips, Miniature | J5220HS | Socket, 3/8" DR 5/8" 6 PT Super Short |
| J4706 | Socket, 1/4" DR 3/16" 6 PT | J5209MHS | Socket, 3/8" DR 9 mm 6 PT Super Short |
| J4707 | Socket, 1/4" DR 7/32" 6 PT | J5210MHS | Socket, 3/8" DR 10 mm 6 PT Super Short |
| J4708 | Socket, 1/4" DR 1/4" 6 PT | J5211MHS | Socket, 3/8" DR 11 mm 6 PT Super Short |
| J4709 | Socket, 1/4" DR 9/32" 6 PT | J5212MHS | Socket, 3/8" DR 12 mm 6 PT Super Short |
| J4710 | Socket, 1/4" DR 5/16" 6 PT | J5213MHS | Socket, 3/8" DR 13 mm 6 PT Super Short |
| J4711 | Socket, 1/4" DR 11/32" 6 PT | J5214MHS | Socket, 3/8" DR 14 mm 6 PT Super Short |
| J4712 | Socket, 1/4" DR 3/8" 6 PT | J5215MHS | Socket, 3/8" DR 15 mm 6 PT Super Short |
| J4714 | Socket, 1/4" DR 7/16" 6 PT | J5216MHS | Socket, 3/8" DR 16 mm 6 PT Super Short |
| J4716 | Socket, 1/4" DR 1/2" 6 PT | J5217MHS | Socket, 3/8" DR 17 mm 6 PT Super Short |
| J4718 | Socket, 1/4" DR 9/16" 6 PT | J5218MHS | Socket, 3/8" DR 18 mm 6 PT Super Short |
| | | J5219MHS | Socket, 3/8" DR 19 mm 6 PT Super Short |
| | | J5210 | Socket, 3/8" DR 5/16" 12 PT |
| | | J5212 | Socket, 3/8" DR 3/8" 12 PT |

MASTER SETS



ADVANCED SETS





| Contents | Description |
|-----------------|---------------------------------------|
| J5214 | Socket, 3/8" DR 7/16" 12 PT |
| J5216 | Socket, 3/8" DR 1/2" 12 PT |
| J5218 | Socket, 3/8" DR 9/16" 12 PT |
| J5220 | Socket, 3/8" DR 5/8" 12 PT |
| J5222 | Socket, 3/8" DR 11/16" 12 PT |
| J5224 | Socket, 3/8" DR 3/4" 12 PT |
| J5226 | Socket, 3/8" DR 13/16" 12 PT |
| J5228 | Socket, 3/8" DR 7/8" 12 PT |
| J5208M | Socket, 3/8" DR 8 mm 12 PT |
| J5206M | Socket, 3/8" DR 6 mm 12 PT |
| J5207M | Socket, 3/8" DR 7 mm 12 PT |
| J5209M | Socket, 3/8" DR 9 mm 12 PT |
| J5210M | Socket, 3/8" DR 10 mm 12 PT |
| J5211M | Socket, 3/8" DR 11 mm 12 PT |
| J5212M | Socket, 3/8" DR 12 mm 12 PT |
| J5213M | Socket, 3/8" DR 13 mm 12 PT |
| J5214M | Socket, 3/8" DR 14 mm 12 PT |
| J5215M | Socket, 3/8" DR 15 mm 12 PT |
| J5216M | Socket, 3/8" DR 16 mm 12 PT |
| J5217M | Socket, 3/8" DR 17 mm 12 PT |
| J5218M | Socket, 3/8" DR 18 mm 12 PT |
| J5219M | Socket, 3/8" DR 19 mm 12 PT |
| J5220M | Socket, 3/8" DR 20 mm 12 PT |
| J5221M | Socket, 3/8" DR 21 mm 12 PT |
| J5222M | Socket, 3/8" DR 22 mm 12 PT |
| J5010 | Socket, 3/8" DR 5/16" 12 PT Deep |
| J5012 | Socket, 3/8" DR 3/8" 12 PT Deep |
| J5014 | Socket, 3/8" DR 7/16" 12 PT Deep |
| J5016 | Socket, 3/8" DR 1/2" 12 PT Deep |
| J5018 | Socket, 3/8" DR 9/16" 12 PT Deep |
| J5020 | Socket, 3/8" DR 5/8" 12 PT Deep |
| J5022 | Socket, 3/8" DR 11/16" 12 PT Deep |
| J5024 | Socket, 3/8" DR 3/4" 12 PT Deep |
| J5026 | Socket, 3/8" DR 13/16" 12 PT Deep |
| J5028 | Socket, 3/8" DR 7/8" 12 PT Deep |
| J5006M | Socket, 3/8" DR 6 mm 12 PT Deep |
| J5007M | Socket, 3/8" DR 7 mm 12 PT Deep |
| J5008M | Socket, 3/8" DR 8 mm 12 PT Deep |
| J5009M | Socket, 3/8" DR 9 mm 12 PT Deep |
| J5010M | Socket, 3/8" DR 10 mm 12 PT Deep |
| J5011M | Socket, 3/8" DR 11 mm 12 PT Deep |
| J5012M | Socket, 3/8" DR 12 mm 12 PT Deep |
| J5013M | Socket, 3/8" DR 13 mm 12 PT Deep |
| J5014M | Socket, 3/8" DR 14 mm 12 PT Deep |
| J5015M | Socket, 3/8" DR 15 mm 12 PT Deep |
| J5016M | Socket, 3/8" DR 16 mm 12 PT Deep |
| J5017M | Socket, 3/8" DR 17 mm 12 PT Deep |
| J5018M | Socket, 3/8" DR 18 mm 12 PT Deep |
| J5019M | Socket, 3/8" DR 19 mm 12 PT Deep |
| J5273AM | Socket, 3/8" DR 10 mm 12 PT Universal |
| J5274AM | Socket, 3/8" DR 11 mm 12 PT Universal |
| J5275AM | Socket, 3/8" DR 12 mm 12 PT Universal |
| J5276AM | Socket, 3/8" DR 13 mm 12 PT Universal |
| J5277AM | Socket, 3/8" DR 14 mm 12 PT Universal |
| J5278AM | Socket, 3/8" DR 15 mm 12 PT Universal |
| J5272AM | Socket, 3/8" DR 9 mm 12 PT Universal |
| J5412 | Socket, 1/2" DR 3/8" 12 PT |
| J5414 | Socket, 1/2" DR 7/16" 12 PT |

| Contents | Description |
|-----------------|------------------------------------|
| J5416 | Socket, 1/2" DR 1/2" 12 PT |
| J5418 | Socket, 1/2" DR 9/16" 12 PT |
| J5420 | Socket, 1/2" DR 5/8" 12 PT |
| J5422 | Socket, 1/2" DR 11/16" 12 PT |
| J5424 | Socket, 1/2" DR 3/4" 12 PT |
| J5426 | Socket, 1/2" DR 13/16" 12 PT |
| J5428 | Socket, 1/2" DR 7/8" 12 PT |
| J5430 | Socket, 1/2" DR 15/16" 12 PT |
| J5432 | Socket, 1/2" DR 1" 12 PT |
| J5434 | Socket, 1/2" DR 1-1/16" 12 PT |
| J5436 | Socket, 1/2" DR 1-1/8" 12 PT |
| J5438 | Socket, 1/2" DR 1-3/16" 12 PT |
| J5440 | Socket, 1/2" DR 1-1/4" 12 PT |
| J5442 | Socket, 1/2" DR 1-5/16" 12 PT |
| J5444 | Socket, 1/2" DR 1-3/8" 12 PT |
| J5446 | Socket, 1/2" DR 1-7/16" 12 PT |
| J5448 | Socket, 1/2" DR 1-1/2" 12 PT |
| J5410M | Socket, 1/2" DR 10 mm 12 PT |
| J5411M | Socket, 1/2" DR 11 mm 12 PT |
| J5412M | Socket, 1/2" DR 12 mm 12 PT |
| J5413M | Socket, 1/2" DR 13 mm 12 PT |
| J5414M | Socket, 1/2" DR 14 mm 12 PT |
| J5415M | Socket, 1/2" DR 15 mm 12 PT |
| J5416M | Socket, 1/2" DR 16 mm 12 PT |
| J5417M | Socket, 1/2" DR 17 mm 12 PT |
| J5418M | Socket, 1/2" DR 18 mm 12 PT |
| J5419M | Socket, 1/2" DR 19 mm 12 PT |
| J5420M | Socket, 1/2" DR 20 mm 12 PT |
| J5421M | Socket, 1/2" DR 21 mm 12 PT |
| J5422M | Socket, 1/2" DR 22 mm 12 PT |
| J5423M | Socket, 1/2" DR 23 mm 12 PT |
| J5424M | Socket, 1/2" DR 24 mm 12 PT |
| J5425M | Socket, 1/2" DR 25 mm 12 PT |
| J5426M | Socket, 1/2" DR 26 mm 12 PT |
| J5427M | Socket, 1/2" DR 27 mm 12 PT |
| J5428M | Socket, 1/2" DR 28 mm 12 PT |
| J5429M | Socket, 1/2" DR 29 mm 12 PT |
| J5430M | Socket, 1/2" DR 30 mm 12 PT |
| J5431M | Socket, 1/2" DR 31 mm 12 PT |
| J5432M | Socket, 1/2" DR 32 mm 12 PT |
| J5436M | Socket, 1/2" DR 36 mm 12 PT |
| J5314 | Socket, 1/2" DR 7/16" 12 PT Deep |
| J5312 | Socket, 1/2" DR 3/8" 12 PT Deep |
| J5316 | Socket, 1/2" DR 1/2" 12 PT Deep |
| J5318 | Socket, 1/2" DR 9/16" 12 PT Deep |
| J5320 | Socket, 1/2" DR 5/8" 12 PT Deep |
| J5322 | Socket, 1/2" DR 11/16" 12 PT Deep |
| J5324 | Socket, 1/2" DR 3/4" 12 PT Deep |
| J5326 | Socket, 1/2" DR 13/16" 12 PT Deep |
| J5328 | Socket, 1/2" DR 7/8" 12 PT Deep |
| J5330 | Socket, 1/2" DR 15/16" 12 PT Deep |
| J5332 | Socket, 1/2" DR 1" 12 PT Deep |
| J5334 | Socket, 1/2" DR 1-1/16" 12 PT Deep |
| J5336 | Socket, 1/2" DR 1-1/8" 12 PT Deep |
| J5338 | Socket, 1/2" DR 1-3/16" 12 PT Deep |
| J5340 | Socket, 1/2" DR 1-1/4" 12 PT Deep |
| J5344 | Socket, 1/2" DR 1-3/8" 12 PT Deep |
| J5346 | Socket, 1/2" DR 1-7/16" 12 PT Deep |

(CONTINUED ON NEXT PAGE)



558 PC METRIC MASTER SET (CONTINUED)



Product #: JCS-0558MAS

| Contents | Description | Contents | Description |
|------------|------------------------------------|-----------|---|
| J5342 | Socket, 1/2" DR 1-5/16" 12 PT Deep | J49905/16 | Socket, Hex Bit 3/8" DR 5/16" |
| J5348 | Socket, 1/2" DR 1-1/2" 12 PT Deep | J4990-4M | Socket, Hex Bit 3/8" DR 4 mm |
| J5310M | Socket, 1/2" DR 10 mm 12 PT Deep | J4990-5M | Socket, Hex Bit 3/8" DR 5 mm |
| J5311M | Socket, 1/2" DR 11 mm 12 PT Deep | J4990-6M | Socket, Hex Bit 3/8" DR 6 mm |
| J5312M | Socket, 1/2" DR 12 mm 12 PT Deep | J4990-7M | Socket, Hex Bit 3/8" DR 7 mm |
| J5313M | Socket, 1/2" DR 13 mm 12 PT Deep | J4990-8M | Socket, Hex Bit 3/8" DR 8 mm |
| J5314M | Socket, 1/2" DR 14 mm 12 PT Deep | J4990-10M | Socket, Hex Bit 3/8" DR 10 mm |
| J5315M | Socket, 1/2" DR 15 mm 12 PT Deep | J5273A | Socket, Universal 3/8" DR 3/8" 12 PT |
| J5316M | Socket, 1/2" DR 16 mm 12 PT Deep | J5274A | Socket, Universal 3/8" DR 7/16" 12 PT |
| J5317M | Socket, 1/2" DR 17 mm 12 PT Deep | J5275A | Socket, Universal 3/8" DR 1/2" 12 PT |
| J5318M | Socket, 1/2" DR 18 mm 12 PT Deep | J5276A | Socket, Universal 3/8" DR 9/16" 12 PT |
| J5319M | Socket, 1/2" DR 19 mm 12 PT Deep | J5277A | Socket, Universal 3/8" DR 5/8" 12 PT |
| J5320M | Socket, 1/2" DR 20 mm 12 PT Deep | J5278A | Socket, Universal 3/8" DR 11/16" 12 PT |
| J5321M | Socket, 1/2" DR 21 mm 12 PT Deep | J5279A | Socket, Universal 3/8" DR 3/4" 12 PT |
| J5322M | Socket, 1/2" DR 22 mm 12 PT Deep | 33-212 | Tape Rule, Stanley® Powerlock® with Metal Case 1/2" x 12" |
| J5323M | Socket, 1/2" DR 23 mm 12 PT Deep | J706L | Wrench, Adjustable CliK-Stop® Chrome, 6" |
| J5324M | Socket, 1/2" DR 24 mm 12 PT Deep | J708L | Wrench, Adjustable CliK-Stop® Chrome, 8" |
| J5325M | Socket, 1/2" DR 25 mm 12 PT Deep | J710L | Wrench, Adjustable CliK-Stop® Chrome, 10" |
| J5326M | Socket, 1/2" DR 26 mm 12 PT Deep | J712L | Wrench, Adjustable CliK-Stop® Chrome, 12" |
| J5241 | Socket, Bit 3/8" DR #2 Phillips® | J1170 | Wrench, Box 5/16" x 3/8" 12 PT |
| J5242 | Socket, Bit 3/8" DR #3 Phillips® | J1171 | Wrench, Box 7/16" x 1/2" 12 PT |
| J5243 | Socket, Bit 3/8" DR #4 Phillips® | J1172 | Wrench, Box 9/16" x 5/8" 12 PT |
| J5246 | Socket, Bit 3/8" DR Slotted | J1173 | Wrench, Box 11/16" x 3/4" 12 PT |
| J47701/16 | Socket, Hex Bit 1/4" DR 1/16" | J1174 | Wrench, Box 13/16" x 7/8" 12 PT |
| J47705/64 | Socket, Hex Bit 1/4" DR 5/64" | J1175 | Wrench, Box 15/16" x 1" 12 PT |
| J47703/32 | Socket, Hex Bit 1/4" DR 3/32" | J1176 | Wrench, Box 1-1/16" x 1-1/8" 12 PT |
| J47707/64 | Socket, Hex Bit 1/4" DR 7/64" | J1050M | Wrench, Box 6 x 7 mm 12 PT |
| J47701/8 | Socket, Hex Bit 1/4" DR 1/8" | J1051M | Wrench, Box 8 x 9 mm 12 PT |
| J47709/64 | Socket, Hex Bit 1/4" DR 9/64" | J1053M | Wrench, Box 10 x 11 mm 12 PT |
| J47705/32 | Socket, Hex Bit 1/4" DR 5/32" | J1057M | Wrench, Box 12 x 13 mm 12 PT |
| J47703/16 | Socket, Hex Bit 1/4" DR 3/16" | J1061M | Wrench, Box 14 x 15 mm 12 PT |
| J47707/32 | Socket, Hex Bit 1/4" DR 7/32" | J1064M | Wrench, Box 16 x 18 mm 12 PT |
| J47701/4 | Socket, Hex Bit 1/4" DR 1/4" | J1065M | Wrench, Box 17 x 19 mm 12 PT |
| J47705/16 | Socket, Hex Bit 1/4" DR 5/16" | J1072M | Wrench, Box 21 x 24 mm 12 PT |
| J4770-2M | Socket, Hex Bit 1/4" DR 2 mm | J1073M | Wrench, Box 22 x 24 mm 12 PT |
| J4770-2.5M | Socket, Hex Bit 1/4" DR 2.5 mm | J1077M | Wrench, Box 27 x 30 mm 12 PT |
| J4770-3M | Socket, Hex Bit 1/4" DR 3 mm | J1079M | Wrench, Box 30 x 32 mm 12 PT |
| J4770-4M | Socket, Hex Bit 1/4" DR 4 mm | J808HD | Wrench, Pipe Heavy-Duty 8" |
| J4770-5M | Socket, Hex Bit 1/4" DR 5 mm | J1210A | Wrench, Combination 5/16" 12 PT |
| J4770-6M | Socket, Hex Bit 1/4" DR 6 mm | J1212ASD | Wrench, Combination 3/8" 12 PT |
| J54411/2 | Socket, Hex Bit 1/2" DR 1/2" | J1214ASD | Wrench, Combination 7/16" 12 PT |
| J54419/16 | Socket, Hex Bit 1/2" DR 9/16" | J1216ASD | Wrench, Combination 1/2" 12 PT |
| J54415/8 | Socket, Hex Bit 1/2" DR 5/8" | J1218ASD | Wrench, Combination 9/16" 12 PT |
| J5441-6M | Socket, Hex Bit 1/2" DR 6 mm | J1220ASD | Wrench, Combination 5/8" 12 PT |
| J5441-8M | Socket, Hex Bit 1/2" DR 8 mm | J1222ASD | Wrench, Combination 11/16" 12 PT |
| J5441-10M | Socket, Hex Bit 1/2" DR 10 mm | J1224ASD | Wrench, Combination 3/4" 12 PT |
| J5441-12M | Socket, Hex Bit 1/2" DR 12 mm | J1226ASD | Wrench, Combination 13/16" 12 PT |
| J5441-14M | Socket, Hex Bit 1/2" DR 14 mm | J1228ASD | Wrench, Combination 7/8" 12 PT |
| J5441-17M | Socket, Hex Bit 1/2" DR 17 mm | J1230ASD | Wrench, Combination 15/16" 12 PT |
| J49901/8 | Socket, Hex Bit 3/8" DR 1/8" | J1232ASD | Wrench, Combination 1" 12 PT |
| J49903/8 | Socket, Hex Bit 3/8" DR 3/8" | J1234ASD | Wrench, Combination 1-1/16" 12 PT |
| J49901/4 | Socket, Hex Bit 3/8" DR 1/4" | J1236ASD | Wrench, Combination 1-1/8" 12 PT |
| J49905/32 | Socket, Hex Bit 3/8" DR 5/32" | J1240ASD | Wrench, Combination 1-1/4" 12 PT |
| J49903/16 | Socket, Hex Bit 3/8" DR 3/16" | J1207MA | Wrench, Combination 7 mm 12 PT |
| J49907/32 | Socket, Hex Bit 3/8" DR 7/32" | | |





| Contents | Description |
|-----------------|--|
| J1208MA | Wrench, Combination 8 mm 12 PT |
| J1209MA | Wrench, Combination 9 mm 12 PT |
| J1210MASD | Wrench, Combination 10 mm 12 PT |
| J1211MASD | Wrench, Combination 11 mm 12 PT |
| J1212MASD | Wrench, Combination 12 mm 12 PT |
| J1213MASD | Wrench, Combination 13 mm 12 PT |
| J1214MASD | Wrench, Combination 14 mm 12 PT |
| J1215MASD | Wrench, Combination 15 mm 12 PT |
| J1216MASD | Wrench, Combination 16 mm 12 PT |
| J1217MASD | Wrench, Combination 17 mm 12 PT |
| J1218MASD | Wrench, Combination 18 mm 12 PT |
| J1219MASD | Wrench, Combination 19 mm 12 PT |
| J1220MASD | Wrench, Combination 20 mm 12 PT |
| J1221MASD | Wrench, Combination 21 mm 12 PT |
| J1222MASD | Wrench, Combination 22 mm 12 PT |
| J1223MASD | Wrench, Combination 23 mm 12 PT |
| J1224MASD | Wrench, Combination 24 mm 12 PT |
| J4912CF | Wrench, Crowfoot 3/8" DR 3/8" Open End |
| J4914CF | Wrench, Crowfoot 3/8" DR 7/16" Open End |
| J4916CF | Wrench, Crowfoot 3/8" DR 1/2" Open End |
| J4918CF | Wrench, Crowfoot 3/8" DR 9/16" Open End |
| J4920CF | Wrench, Crowfoot 3/8" DR 5/8" Open End |
| J4922CF | Wrench, Crowfoot 3/8" DR 11/16" Open End |
| J4924CF | Wrench, Crowfoot 3/8" DR 3/4" Open End |
| J4926CF | Wrench, Crowfoot 3/8" DR 13/16" Open End |
| J4928CF | Wrench, Crowfoot 3/8" DR 7/8" Open End |
| J4909MCF | Wrench, Crowfoot 3/8" DR 9 mm Open End |
| J4910MCF | Wrench, Crowfoot 3/8" DR 10 mm Open End |
| J4911MCF | Wrench, Crowfoot 3/8" DR 11 mm Open End |
| J4912MCF | Wrench, Crowfoot 3/8" DR 12 mm Open End |
| J4913MCF | Wrench, Crowfoot 3/8" DR 13 mm Open End |
| J4914MCF | Wrench, Crowfoot 3/8" DR 14 mm Open End |
| J4915MCF | Wrench, Crowfoot 3/8" DR 15 mm Open End |
| J4916MCF | Wrench, Crowfoot 3/8" DR 16 mm Open End |
| J4917MCF | Wrench, Crowfoot 3/8" DR 17 mm Open End |
| J4918MCF | Wrench, Crowfoot 3/8" DR 18 mm Open End |
| J4919MCF | Wrench, Crowfoot 3/8" DR 19 mm Open End |
| J4920MCF | Wrench, Crowfoot 3/8" DR 20 mm Open End |
| J4921MCF | Wrench, Crowfoot 3/8" DR 21 mm Open End |
| J4922MCF | Wrench, Crowfoot 3/8" DR 22 mm Open End |
| J4923MCF | Wrench, Crowfoot 3/8" DR 23 mm Open End |
| J4924MCF | Wrench, Crowfoot 3/8" DR 24 mm Open End |

| Contents | Description |
|-----------------|--|
| J3764 | Wrench, Flare Nut 3/8" x 7/16" 6 PT |
| J3768 | Wrench, Flare Nut 1/2" x 9/16" 6 PT |
| J3772 | Wrench, Flare Nut 5/8" x 11/16" 6 PT |
| J3707M | Wrench, Flare Nut 7 mm x 8 mm |
| J3709M | Wrench, Flare Nut 9 mm x 11 mm |
| J3710M | Wrench, Flare Nut 10 mm x 12 mm |
| J3713M | Wrench, Flare Nut 13 mm x 14 mm |
| J3715M | Wrench, Flare Nut 15 mm x 17 mm |
| J3018 | Wrench, Open End 1/4" x 5/16" |
| J3020 | Wrench, Open End 3/8" x 5/16" |
| J3025 | Wrench, Open End 7/16" x 1/2" |
| J3026 | Wrench, Open End 1/2" x 9/16" |
| J3030 | Wrench, Open End 9/16" x 5/8" |
| J3031 | Wrench, Open End 5/8" x 3/4" |
| J3035 | Wrench, Open End 11/16" x 3/4" |
| J3040 | Wrench, Open End 13/16" x 7/8" |
| J3045 | Wrench, Open End 15/16" x 1" |
| J3050 | Wrench, Open End 1-1/16" x 1-1/8" |
| J30607 | Wrench, Open End 6 mm x 7 mm |
| J30809 | Wrench, Open End 8 mm x 9 mm |
| J31011 | Wrench, Open End 10 mm x 11 mm |
| J31213 | Wrench, Open End 12 mm x 13 mm |
| J31415 | Wrench, Open End 14 mm x 15 mm |
| J31617 | Wrench, Open End 16 mm x 17 mm |
| J31819 | Wrench, Open End 18 mm x 19 mm |
| J32022 | Wrench, Open End 20 mm x 22 mm |
| J32123 | Wrench, Open End 21 mm x 23 mm |
| J32426 | Wrench, Open End 24 mm x 26 mm |
| J810HD | Wrench, Pipe Heavy-Duty 10" |
| J814HD | Wrench, Pipe Heavy-Duty 14" |
| J1191T-A | Wrench, Ratcheting Box 1/4" x 5/16" 12 PT |
| J1192T-A | Wrench, Ratcheting Box 3/8" x 7/16" 12 PT |
| J1193T-A | Wrench, Ratcheting Box 1/2" x 9/16" 12 PT |
| J1194-A | Wrench, Ratcheting Box 5/8" x 11/16" 12 PT |
| J1195-A | Wrench, Ratcheting Box 3/4" x 7/8" 12 PT |
| J1191M-A | Wrench, Ratcheting Box 7 mm x 8 mm |
| J1192M-A | Wrench, Ratcheting Box 9 mm x 10 mm |
| J1193MA-A | Wrench, Ratcheting Box 11 mm x 12 mm |
| J1194MA-A | Wrench, Ratcheting Box 13 mm x 14 mm |
| J1195M-A | Wrench, Ratcheting Box 15 mm x 17 mm |
| J6016C | Wrench, Torque 1/2" DR 30-150 ft-lbs |

558 PC METRIC MASTER SET WITH WORKSTATION J455041-10RD

Product #: **JCS-0558MASBX1**



- › 558 Pieces.
- › 1/4", 3/8", 1/2" Drive Tools.
- › Designed for fastener sizes 1/4" - 1-1/2", 2 mm - 36 mm.
- › Contains: 279 Sockets and Accessories, 119 Wrenches, 31 Striking and Struck Tools, 27 Pliers, 43 Screwdrivers, 59 Miscellaneous Tools.
- › Enhanced version of Proto® J99561 Metric Master Set.
- › Weight: 698.0 lbs.



Representative Image; Contents May Differ

558 PC METRIC MASTER SET WITH WORKSTATION J444142-6RD

Product #: **JCS-0558MASBX2**



- › 58 Pieces.
- › 1/4", 3/8", 1/2" Drive Tools.
- › Designed for fastener sizes 1/4" - 1-1/2", 2 mm - 36 mm.
- › Contains: 279 Sockets and Accessories, 119 Wrenches, 31 Striking and Struck Tools, 27 Pliers, 43 Screwdrivers, 59 Miscellaneous Tools.
- › Enhanced version of Proto® J99562 Metric Master Set.
- › Weight: 471.0 lbs.



Representative Image; Contents May Differ



411 PC ADVANCED MAINTENANCE TOOL SET

Product #: J99830

- › 411 Pieces.
- › 1/4", 3/8", 1/2" Drive Tools.
- › Designed for fastener sizes 1/16" - 1-7/16".
- › Tools Only.

- › Contains: 182 Sockets and Accessories, 99 Wrenches, 31 Striking and Struck Tools, 28 Pliers, 32 Screwdrivers, 39 Miscellaneous Tools.
- › Sub-sets contained: J99810, J99825, J99835.
- › Weight: 192.0 lbs.



Representative Image; Contents May Differ

| Contents | Description |
|-----------|----------------------------------|
| J4770A | Adapter, Universal Joint 1/4" DR |
| J5470A | Adapter, Universal Joint 1/2" DR |
| J5270A | Adapter, Universal Joint 3/8" DR |
| J2126 | Bar, 12" Long 1/2" Tip |
| J2130 | Bar, 16" Long 5/8" Tip |
| J2120 | Bar, Pry Aligning 18" |
| J2124 | Bar, Pry Aligning 24" |
| J404 | C-Clamps, Capacity 0"-4", 2 Each |
| J86A3/16 | Chisel, Cold 1/4" |
| J86A1/4 | Chisel, Cold 5/16" |
| J86A5/16 | Chisel, Cold 3/8" |
| J86A7/16 | Chisel, Cold 1/2" |
| J86A1/2 | Chisel, Cold 5/8" |
| J86A5/8 | Chisel, Cold 3/4" |
| J86A3/4X8 | Chisel, Cold 7/8" |
| J86A7/8X8 | Chisel, Cold 1" |
| J86A1X8 | Chisel, Cold 1-3/16" |
| J2306 | Puller, Cotter Pin Tool |
| J4769 | Driver, 1/4" DR |
| J9521 | Extractor, Screw 1/8" |
| J9522 | Extractor, Screw 3/16" |
| J9523 | Extractor, Screw 15/64" |
| J9524 | Extractor, Screw 5/16" |
| J9525 | Extractor, Screw 3/8" |
| J9525B | Extractor, Screw 15/32" |
| J9526 | Extractor, Screw 9/16" |
| J9527 | Extractor, Screw 21/32" |
| J9528 | Extractor, Screw 13/16" |
| J9529 | Extractor, Screw 1-1/16" |
| J4759 | Extension, 1/4" DR 2" |
| J4760 | Extension, 1/4" DR 3" |
| J4761 | Extension, 1/4" DR 6" |
| J5260 | Extension, 3/8" DR 3" |
| J5260-06 | Extension, 3/8" DR 6" |
| J5262 | Extension, 3/8" DR 12" |
| J5460 | Extension, 1/2" DR 2-1/2" |
| J5461 | Extension, 1/2" DR 5" |
| J5463 | Extension, 1/2" DR 10" |
| J4765 | Extension, Flex 1/4" DR 6-1/4" |
| J5268 | Extension, Flex 3/8" DR 8" |
| J5260W | Extension, Wobble 3/8" DR 3" |
| J5260-06W | Extension, Wobble 3/8" DR 6" |
| J95218 | Knife, Folding Blade |
| 15-265 | Hacksaw, 3-7/8" |
| J1308PD | Hammer, Ball Pein 8 oz. |
| J1316PD | Hammer, Ball Pein 16 oz. |
| J1332PD | Hammer, Ball Pein 32 oz. |
| 28-240 | Scraper, Flexible Nylon 1-1/4" |
| J4766 | Handle, Hinge 1/4" DR 5-3/4" |
| J5265 | Handle, Hinge 3/8" DR 8-1/2" |
| J5468 | Handle, Hinge 1/2" DR |

(CONTINUED ON NEXT PAGE)



411 PC ADVANCED MAINTENANCE TOOL SET (CONTINUED)

Product #: J99830



| Contents | Description | Contents | Description |
|--------------|---|----------|--|
| J4785 | Handle, Sliding T 1/4" DR | J501/4 | Punch, Starting 3/32" |
| J5285 | Handle, Sliding T 3/8" DR | J505/16 | Punch, Starting 1/8" |
| J5485 | Handle, Sliding T 1/2" DR | J503/8 | Punch, Starting 3/16" |
| J4780G | Handle, Speed 1/4" DR | J507/16 | Punch, Starting 7/32" |
| J5280G | Handle, Speed 3/8" DR | J501/2 | Punch, Starting 1/4" |
| J5480G | Handle, Speed 1/2" DR | J5247 | Ratchet Adapter 3/8" DR 2-1/16" |
| J4980 | Hex Key, 13 PC Standard Set | J5447 | Ratchet Adapter 1/2" DR 2-21/32" |
| J2108 | Holder, Punch and Chisel | J4749 | Ratchet, 1/4" DR |
| J18545B | Knife, Lockback 5" | J5249 | Ratchet, 3/8" DR |
| 10-099 | Knife, Stanley® Classic 99® Retractable Blade Utility | J5449 | Ratchet, 1/2" DR |
| J1368 | Mallet, Rubber | J5450 | Ratchet, 1/2" DR (Long Handle) |
| J2373 | Mirror, Rectangular Telescoping 2-1/8" | J5257F | Ratchet, 3/8" DR Flex-Head 2-1/16" |
| J9206 | Nut Driver, 3/16" | J5457F | Ratchet, 1/2" DR Flex-Head 17-3/32" |
| J9207 | Nut Driver, 7/32" | J2375 | Retrieval Tool, Pocket Magnetic |
| J9208 | Nut Driver, 1/4" | 28-540 | Scraper, Flexible 1-1/4" Wood Handle |
| J9209 | Nut Driver, 9/32" | J2336 | Scrapers, Gasket and Carbon |
| J9210 | Nut Driver, 5/16" | J9884 | Screw Starter, Phillips® Tip |
| J9211 | Nut Driver, 11/32" | J9853 | Screw Starter, Standard Tip |
| J9212 | Nut Driver, 3/8" | J88208 | Screwdriver, Slotted Cabinet, Round 1/8" x 8" |
| J9214 | Nut Driver 7/16" | J88204 | Screwdriver, Slotted Cabinet, Round 1/8" x 4" |
| J9216 | Nut Driver, 1/2" | J88203 | Screwdriver, Slotted Cabinet, Round 1/8" x 3" |
| J9218 | Nut Driver, 9/16" | J88218 | Screwdriver, Slotted Cabinet, Round 3/16" x 8" |
| J9220 | Nut Driver, 5/8" | J88214 | Screwdriver, Slotted Cabinet, Round 3/16" x 4" |
| J206G | Pliers, Diagonal Cutting with Grip 6-1/16" | J88393 | Screwdriver, Phillips® #0 |
| J209G | Pliers, Diagonal Cutting with Grip 7-5/16" | J88318 | Screwdriver, Phillips® #1 |
| J227G | Pliers, Duckbill with Grip 7-25/32" | J88313 | Screwdriver, Phillips® #1 |
| J272G | Pliers, End Cutting High Leverage 8-1/4" | J88328 | Screwdriver, Phillips® #2 |
| J268G | Pliers, Lineman's with Grip 8-5/8" | J88324 | Screwdriver, Phillips® #2 |
| J292NC | Pliers, Locking Curved 10" | J88322 | Screwdriver, Phillips® #2 |
| J286LNXL | Pliers, Locking Mini Long Nose 6-29/32" | J88336 | Screwdriver, Phillips® #3 |
| J291NC | Pliers, Locking Straight 7" | J88348 | Screwdriver, Phillips® #4 |
| J225G | Pliers, Needle-Nose Bent Nose 6-5/16" | J88102 | Screwdriver, Slotted Keystone, Square 1/4" x 2" |
| J222G | Pliers, Needle-Nose Long Thin 6-1/16" | J88104 | Screwdriver, Slotted Keystone, Square 1/4" x 4" |
| J226G | Pliers, Needle-Nose with Cutter 6-5/8" | J88106 | Screwdriver, Slotted Keystone, Square 1/4" x 6" |
| J360B | Pliers, 12 PC Set Convertible Retaining Ring | J88108 | Screwdriver, Slotted Keystone, Square 1/4" x 8" |
| J278G | Pliers, Slip-Joint with Grip 8-1/16" | J88112 | Screwdriver, Slotted Keystone, Square 1/4" x 12" |
| J276G | Pliers, Slip-Joint with Grip 6-9/16" | J88002 | Screwdriver, Slotted Keystone, Round 1/4" x 1-1/2" |
| J298 | Pliers, Wire Strippers 8-1/4" | J303S | Snips, Aviation Straight |
| J4056-4 | Puller, Jaw Reversible 4 R | J308 | Snips, Miniature |
| J4250N | Puller, Nut Adjustable Reversible | J4708 | Socket, 1/4" DR 1/4" 6 PT |
| J4056PN | Puller, Pin Pivot | J4707 | Socket, 1/4" DR 7/32" 6 PT |
| J4205S | Puller, Screw Forcing Acme | J4706 | Socket, 1/4" DR 3/16" 6 PT |
| J4022T | Puller, Tip Detachable Standard | J4709 | Socket, 1/4" DR 9/32" 6 PT |
| J4255B | Puller, Yoke 3 Way Jaw ACM | J4710 | Socket, 1/4" DR 5/16" 6 PT |
| J413/8 | Punch, Center 3/8" | J4711 | Socket, 1/4" DR 11/32" 6 PT |
| J411/2 | Punch, Center 1/2" | J4712 | Socket, 1/4" DR 3/8" 6 PT |
| J965/16 | Punch, Drift 1/8" | J4714 | Socket, 1/4" DR 7/16" 6 PT |
| J963/8 | Punch, Drift 3/16" | J4716 | Socket, 1/4" DR 1/2" 6 PT |
| J961/2 | Punch, Drift 1/4" | J4718 | Socket, 1/4" DR 9/16" 6 PT |
| J471/4X3/32 | Punch, Pin 3/32" | J4707L | Socket, 1/4" DR 7/32" 6 PT Deep |
| J475/16X1/8 | Punch, Pin 1/8" | J4706L | Socket, 1/4" DR 3/16" 6 PT Deep |
| J475/16X5/32 | Punch, Pin 5/32" | J4708L | Socket, 1/4" DR 1/4" 6 PT Deep |
| J473/8X3/16 | Punch, Pin 3/16" | J4709L | Socket, 1/4" DR 9/32" 6 PT Deep |
| J477/16X7/32 | Punch, Pin 7/32" | J4710L | Socket, 1/4" DR 5/16" 6 PT Deep |
| J471/2X1/4 | Punch, Pin 1/4" | J4711L | Socket, 1/4" DR 11/32" 6 PT Deep |
| J445/16 | Punch, Prick 5/16" | J4712L | Socket, 1/4" DR 3/8" 6 PT Deep |





| Contents | Description |
|----------|-----------------------------------|
| J4716L | Socket, 1/4" DR 1/2" 6 PT Deep |
| J4714L | Socket, 1/4" DR 7/16" 6 PT Deep |
| J4718L | Socket, 1/4" DR 9/16" 6 PT Deep |
| J4708S | Socket, 1/4" DR 1/4" 8 PT |
| J4710S | Socket, 1/4" DR 5/16" 8 PT |
| J4712S | Socket, 1/4" DR 3/8" 8 PT |
| J5208S | Socket, 3/8" DR 1/4" 8 PT |
| J5210S | Socket, 3/8" DR 5/16" 8 PT |
| J5210 | Socket, 3/8" DR 5/16" 12 PT |
| J5212S | Socket, 3/8" DR 3/8" 8 PT |
| J5214S | Socket, 3/8" DR 7/16" 8 PT |
| J5216S | Socket, 3/8" DR 1/2" 8 PT |
| J5208 | Socket, 3/8" DR 1/4" 12 PT |
| J5212 | Socket, 3/8" DR 3/8" 12 PT |
| J5214 | Socket, 3/8" DR 7/16" 12 PT |
| J5216 | Socket, 3/8" DR 1/2" 12 PT |
| J5218 | Socket, 3/8" DR 9/16" 12 PT |
| J5220 | Socket, 3/8" DR 5/8" 12 PT |
| J5222 | Socket, 3/8" DR 11/16" 12 PT |
| J5224 | Socket, 3/8" DR 3/4" 12 PT |
| J5226 | Socket, 3/8" DR 13/16" 12 PT |
| J5228 | Socket, 3/8" DR 7/8" 12 PT |
| J5230 | Socket, 3/8" DR 15/16" 12 PT |
| J5232 | Socket, 3/8" DR 1" 12 PT |
| J5008 | Socket, 3/8" DR 1/4" 12 PT Deep |
| J5010 | Socket, 3/8" DR 5/16" 12 PT Deep |
| J5012 | Socket, 3/8" DR 3/8" 12 PT Deep |
| J5014 | Socket, 3/8" DR 7/16" 12 PT Deep |
| J5016 | Socket, 3/8" DR 1/2" 12 PT Deep |
| J5018 | Socket, 3/8" DR 9/16" 12 PT Deep |
| J5020 | Socket, 3/8" DR 5/8" 12 PT Deep |
| J5022 | Socket, 3/8" DR 11/16" 12 PT Deep |
| J5024 | Socket, 3/8" DR 3/4" 12 PT Deep |
| J5026 | Socket, 3/8" DR 13/16" 12 PT Deep |
| J5028 | Socket, 3/8" DR 7/8" 12 PT Deep |
| J5030 | Socket, 3/8" DR 15/16" 12 PT Deep |
| J5032 | Socket, 3/8" DR 1" 12 PT Deep |
| J5412S | Socket, 1/2" DR 3/8" 8 PT |
| J5414S | Socket, 1/2" DR 7/16" 8 PT |
| J5416S | Socket, 1/2" DR 1/2" 8 PT |
| J5418S | Socket, 1/2" DR 9/16" 8 PT |
| J5420S | Socket, 1/2" DR 5/8" 8 PT |
| J5422S | Socket, 1/2" DR 11/16" 8 PT |
| J5424S | Socket, 1/2" DR 3/4" 8 PT |
| J5426S | Socket, 1/2" DR 13/16" 8 PT |
| J5428S | Socket, 1/2" DR 7/8" 8 PT |
| J5432S | Socket, 1/2" DR 1" 8 PT |
| J5412 | Socket, 1/2" DR 3/8" 12 PT |
| J5414 | Socket, 1/2" DR 7/16" 12 PT |
| J5416 | Socket, 1/2" DR 1/2" 12 PT |
| J5418 | Socket, 1/2" DR 9/16" 12 PT |
| J5419 | Socket, 1/2" DR 19/32" 12 PT |
| J5420 | Socket, 1/2" DR 5/8" 12 PT |
| J5422 | Socket, 1/2" DR 11/16" 12 PT |
| J5424 | Socket, 1/2" DR 3/4" 12 PT |
| J5425 | Socket, 1/2" DR 25/32" 12 PT |
| J5426 | Socket, 1/2" DR 13/16" 12 PT |
| J5428 | Socket, 1/2" DR 7/8" 12 PT |
| J5429 | Socket, 1/2" DR 29/32" 12 PT |

| Contents | Description |
|-----------|---|
| J5430 | Socket, 1/2" DR 15/16" 12 PT |
| J5432 | Socket, 1/2" DR 1" 12 PT |
| J5434 | Socket, 1/2" DR 1-1/16" 12 PT |
| J5436 | Socket, 1/2" DR 1-1/8" 12 PT |
| J5438 | Socket, 1/2" DR 1-3/16" 12 PT |
| J5440 | Socket, 1/2" DR 1-1/4" 12 PT |
| J5442 | Socket, 1/2" DR 1-5/16" 12 PT |
| J5444 | Socket, 1/2" DR 1-3/8" 12 PT |
| J5446 | Socket, 1/2" DR 1-7/16" 12 PT |
| J5448 | Socket, 1/2" DR 1-1/2" 12 PT |
| J5316 | Socket, 1/2" DR 1/2" 12 PT Deep |
| J5320 | Socket, 1/2" DR 5/8" 12 PT Deep |
| J5322 | Socket, 1/2" DR 11/16" 12 PT Deep |
| J5324 | Socket, 1/2" DR 3/4" 12 PT Deep |
| J5326 | Socket, 1/2" DR 13/16" 12 PT Deep |
| J5330 | Socket, 1/2" DR 15/16" 12 PT Deep |
| J5332 | Socket, 1/2" DR 1" 12 PT Deep |
| J5334 | Socket, 1/2" DR 1-1/16" 12 PT Deep |
| J5336 | Socket, 1/2" DR 1-1/8" 12 PT Deep |
| J5340 | Socket, 1/2" DR 1-1/4" 12 PT Deep |
| J5318 | Socket, 1/2" DR 9/16" 12 PT Deep |
| J5328 | Socket, 1/2" DR 7/8" 12 PT Deep |
| J5444A | Socket, 1/2" DR Drag Link 3/4" |
| J5446A | Socket, 1/2" DR Drag Link 15/16" |
| J4737 | Socket, Bit 1/4" DR #1 Phillips® |
| J4738 | Socket, Bit 1/4" DR #2 Phillips® |
| J4743 | Socket, Bit 1/4" DR Slotted 1/4" 1-3/16" |
| J4744 | Socket, Bit 1/4" DR Slotted 3/16" |
| J4745 | Socket, Bit 1/4" DR Slotted 1/4" 1-13/64" |
| J5241 | Socket, Bit 3/8" DR #2 Phillips® |
| J5242 | Socket, Bit 3/8" DR #3 Phillips® |
| J5243 | Socket, Bit 3/8" DR #4 Phillips® |
| J5246 | Socket, Bit 3/8" DR Slotted |
| J47701/16 | Socket, Hex Bit 1/4" DR 1/16" |
| J47705/64 | Socket, Hex Bit 1/4" DR 5/64" |
| J47703/32 | Socket, Hex Bit 1/4" DR 3/32" |
| J47707/64 | Socket, Hex Bit 1/4" DR 7/64" |
| J47701/8 | Socket, Hex Bit 1/4" DR 1/8" |
| J47709/64 | Socket, Hex Bit 1/4" DR 9/64" |
| J47705/32 | Socket, Hex Bit 1/4" DR 5/32" |
| J47703/16 | Socket, Hex Bit 1/4" DR 3/16" |
| J47707/32 | Socket, Hex Bit 1/4" DR 7/32" |
| J47701/4 | Socket, Hex Bit 1/4" DR 1/4" |
| J47705/16 | Socket, Hex Bit 1/4" DR 5/16" |
| J49901/8 | Socket, Hex Bit 3/8" DR 1/8" |
| J49905/32 | Socket, Hex Bit 3/8" DR 5/32" |
| J49903/16 | Socket, Hex Bit 3/8" DR 3/16" |
| J49901/4 | Socket, Hex Bit 3/8" DR 1/4" |
| J49907/32 | Socket, Hex Bit 3/8" DR 7/32" |
| J49905/16 | Socket, Hex Bit 3/8" DR 5/16" |
| J49903/8 | Socket, Hex Bit 3/8" DR 3/8" |
| J54411/4 | Socket, Hex Bit 1/2" DR 1/4" |
| J54415/16 | Socket, Hex Bit 1/2" DR 5/16" |
| J54413/8 | Socket, Hex Bit 1/2" DR 3/8" |
| J54417/16 | Socket, Hex Bit 1/2" DR 7/16" |
| J54411/2 | Socket, Hex Bit 1/2" DR 1/2" |
| J54419/16 | Socket, Hex Bit 1/2" DR 9/16" |
| J54415/8 | Socket, Hex Bit 1/2" DR 5/8" |
| J4771TA | Socket, Universal 1/4" DR 1/4" 12 PT |

(CONTINUED ON NEXT PAGE)

411 PC ADVANCED MAINTENANCE TOOL SET (CONTINUED)

Product #: **J99830**



| Contents | Description | Contents | Description |
|----------|--|----------|--|
| J4772TA | Socket, Universal 1/4" DR 5/16" 12 PT | J1208EF | Wrench, Combination 1/4" 6 PT Short |
| J4773TA | Socket, Universal 1/4" DR 3/8" 12 PT | J1209EF | Wrench, Combination 9/32" 6 PT Short |
| J4774TA | Socket, Universal 1/4" DR 7/16" 12 PT | J1210EF | Wrench, Combination 5/16" 6 PT Short |
| J5273A | Socket, Universal 3/8" DR 3/8" 12 PT | J1211EF | Wrench, Combination 11/32" 6 PT Short |
| J5274A | Socket, Universal 3/8" DR 7/16" 12 PT | J1212EF | Wrench, Combination 3/8" 6 PT Short |
| J5275A | Socket, Universal 3/8" DR 1/2" 12 PT | J4912CF | Wrench, Crowfoot 3/8" DR 3/8" Open End |
| J5276A | Socket, Universal 3/8" DR 9/16" 12 PT | J4914CF | Wrench, Crowfoot 3/8" DR 7/16" Open End |
| J5277A | Socket, Universal 3/8" DR 5/8" 12 PT | J4916CF | Wrench, Crowfoot 3/8" DR 1/2" Open End |
| J5278A | Socket, Universal 3/8" DR 11/16" 12 PT | J4918CF | Wrench, Crowfoot 3/8" DR 9/16" Open End |
| J5279A | Socket, Universal 3/8" DR 3/4" 12 PT | J4920CF | Wrench, Crowfoot 3/8" DR 5/8" Open End |
| J5475A | Socket, Universal 1/2" DR 1/2" 12 PT | J4922CF | Wrench, Crowfoot 3/8" DR 11/16" Open End |
| J5476A | Socket, Universal 1/2" DR 9/16" 12 PT | J4924CF | Wrench, Crowfoot 3/8" DR 3/4" Open End |
| J5477A | Socket, Universal 1/2" DR 5/8" 12 PT | J4926CF | Wrench, Crowfoot 3/8" DR 13/16" Open End |
| J706 | Wrench, Adjustable 6" | J4928CF | Wrench, Crowfoot 3/8" DR 7/8" Open End |
| J708 | Wrench, Adjustable 8" | J3751 | Wrench, Flare Nut Combination 3/8" 6 PT |
| J710 | Wrench, Adjustable 10" | J3752 | Wrench, Flare Nut Combination 7/16" 6 PT |
| J712 | Wrench, Adjustable 12" | J3753 | Wrench, Flare Nut Combination 1/2" 6 PT |
| J3314 | Wrench, Angle 7/32" | J3754 | Wrench, Flare Nut Combination 9/16" 6 PT |
| J3315 | Wrench, Angle 15/64" | J3755 | Wrench, Flare Nut Combination 5/8" 6 PT |
| J3316 | Wrench, Angle 1/4" | J3756 | Wrench, Flare Nut Combination 11/16" 6 PT |
| J3318 | Wrench, Angle 9/32" | J3757 | Wrench, Flare Nut Combination 3/4" 6 PT |
| J3320 | Wrench, Angle 5/16" | J3812 | Wrench, Flare Nut Ratcheting 3/8" |
| J3322 | Wrench, Angle 11/32" | J3814 | Wrench, Flare Nut Ratcheting 7/16" |
| J3324 | Wrench, Angle 3/8" | J3816 | Wrench, Flare Nut Ratcheting 1/2" |
| J3328 | Wrench, Angle 7/16" | J3818 | Wrench, Flare Nut Ratcheting 9/16" |
| J3332 | Wrench, Angle 1/2" | J3820 | Wrench, Flare Nut Ratcheting 5/8" |
| J1170 | Wrench, Box 5/16" x 3/8" 12 PT | J3822 | Wrench, Flare Nut Ratcheting 11/16" |
| J1171 | Wrench, Box 7/16" x 1/2" 12 PT | J3824 | Wrench, Flare Nut Ratcheting 3/4" |
| J1172 | Wrench, Box 9/16" x 5/8" 12 PT | J1725 | Wrench, Obstruction 7/16" x 1/2" |
| J1173 | Wrench, Box 11/16" x 3/4" 12 PT | J1730 | Wrench, Obstruction 9/16" x 5/8" |
| J1174 | Wrench, Box 13/16" x 7/8" 12 PT | J1731 | Wrench, Obstruction 5/8" x 3/4" |
| J1175 | Wrench, Box 15/16" x 1" 12 PT | J3018 | Wrench, Open End 1/4" x 5/16" |
| J1176 | Wrench, Box 1-1/16" x 1-1/8" 12 PT | J3020 | Wrench, Open End 3/8" x 5/16" |
| J1122 | Wrench, Box 3/8" x 7/16" 12 PT Short | J3025 | Wrench, Open End 7/16" x 1/2" |
| J1120 | Wrench, Box 5/16" x 3/8" 12 PT Short | J3026 | Wrench, Open End 1/2" x 9/16" |
| J1126 | Wrench, Box 1/2" x 9/16" 12 PT Short | J3030 | Wrench, Open End 9/16" x 5/8" |
| J1131 | Wrench, Box 5/8" x 3/4" 12 PT Short | J3031 | Wrench, Open End 5/8" x 3/4" |
| J808HD | Wrench, Pipe Heavy-Duty 8" | J3035 | Wrench, Open End 11/16" x 3/4" |
| J1210A | Wrench, Combination 5/16" 12 PT | J3040 | Wrench, Open End 13/16" x 7/8" |
| J1212ASD | Wrench, Combination 3/8" 12 PT | J3045 | Wrench, Open End 15/16" x 1" |
| J1214ASD | Wrench, Combination 7/16" 12 PT | J3050 | Wrench, Open End 1-1/16" x 1-1/8" |
| J1216ASD | Wrench, Combination 1/2" 12 PT | J810HD | Wrench, Pipe Heavy-Duty 10" |
| J1218ASD | Wrench, Combination 9/16" 12 PT | J814HD | Wrench, Pipe Heavy-Duty 14" |
| J1220ASD | Wrench, Combination 5/8" 12 PT | J1191T-A | Wrench, Ratcheting Box 1/4" x 5/16" 12 PT |
| J1222ASD | Wrench, Combination 11/16" 12 PT | J1192T-A | Wrench, Ratcheting Box 3/8" x 7/16" 12 PT |
| J1224ASD | Wrench, Combination 3/4" 12 PT | J1193T-A | Wrench, Ratcheting Box 1/2" x 9/16" 12 PT |
| J1226ASD | Wrench, Combination 13/16" 12 PT | J1194-A | Wrench, Ratcheting Box 5/8" x 11/16" 12 PT |
| J1228ASD | Wrench, Combination 7/8" 12 PT | J1195-A | Wrench, Ratcheting Box 3/4" x 7/8" 12 PT |
| J1230ASD | Wrench, Combination 15/16" 12 PT | J1270-12 | Wrench, Swivel Combination 3/8" 12 PT |
| J1232ASD | Wrench, Combination 1" 12 PT | J1270-14 | Wrench, Swivel Combination 7/16" 12 PT |
| J1234ASD | Wrench, Combination 1-1/16" 12 PT | J1270-16 | Wrench, Swivel Combination 1/2" 12 PT |
| J1236ASD | Wrench, Combination 1-1/8" 12 PT | J1270-18 | Wrench, Swivel Combination 9/16" 12 PT |
| J1240ASD | Wrench, Combination 1-1/4" 12 PT | J1270-20 | Wrench, Swivel Combination 5/8" 12 PT |
| J1204EF | Wrench, Combination 1/8" 6 PT Short | J1270-22 | Wrench, Swivel Combination 11/16" 12 PT |
| J1205EF | Wrench, Combination 5/32" 6 PT Short | J1270-24 | Wrench, Swivel Combination 3/4" 12 PT |
| J1206EF | Wrench, Combination 3/16" 6 PT Short | J6016C | Wrench, Torque 1/2" DR 30-150 ft-lbs |



411 PC ADVANCED MAINTENANCE SET WITH ROLLER CABINET J442735-7RD AND TOP CHEST J442719-10RD-D

Product #: J99831



- › 411 Pieces.
- › 1/4", 3/8", 1/2" Drive Tools.
- › Designed for fastener sizes 1/16" - 1-7/16".
- › Contains: 183 Sockets and Accessories, 99 Wrenches, 31 Striking and Struck Tools, 26 Pliers, 21 Screwdrivers, 51 Miscellaneous Tools.
- › Sub-sets contained: J99810, J99825, J99835.
- › Weight: 615.0 lbs.



Representative Image; Contents May Differ

411 PC ADVANCED MAINTENANCE SET WITH ROLLER CABINET J442742-7RD AND TOP CHEST J442719-8RD

Product #: J99832



- › 411 Pieces.
- › 1/4", 3/8", 1/2" Drive Tools.
- › Designed for fastener sizes 1/16" - 1-7/16".
- › Contains: 183 Sockets and Accessories, 99 Wrenches, 31 Striking and Struck Tools, 26 Pliers, 21 Screwdrivers, 51 Miscellaneous Tools.
- › Sub-sets contained: J99810, J99825, J99835.
- › Weight: 624.0 lbs.



Representative Image; Contents May Differ



400 PC ADVANCED MAINTENANCE TOOL SET

Product #: **J99680**

- › 400 Pieces.
- › 3/8", 1/2", 3/4" Drive Tools.
- › Designed for fastener sizes 1/8" - 2-3/8".
- › Tools only.
- › Contains: 158 Sockets and Accessories, 104 Wrenches, 34 Striking and Struck Tools, 33 Pliers, 30 Screwdrivers, 41 Miscellaneous Tools.
- › Sub-sets contained: J99660, J99665, J99675.
- › Weight: 297.0 lbs.



Representative Image; Contents May Differ

| Contents | Description |
|-----------|----------------------------------|
| J5270A | Adapter, Universal Joint 3/8" DR |
| J5470A | Adapter, Universal Joint 1/2" DR |
| J5670 | Adapter, Universal Joint 3/4" DR |
| J2126 | Bar, 12" Long 1/2" Tip |
| J2130 | Bar, 16" Long 5/8" Tip |
| J2120 | Bar, Pry Aligning 18" |
| J2124 | Bar, Pry Aligning 24" |
| J404 | C-Clamps, Capacity 0"-4", 2 Each |
| J86A3/16 | Chisel, Cold 1/4" |
| J86A1/4 | Chisel, Cold 5/16" |
| J86A5/16 | Chisel, Cold 3/8" |
| J86A7/16 | Chisel, Cold 1/2" |
| J86A1/2 | Chisel, Cold 5/8" |
| J86A5/8 | Chisel, Cold 3/4" |
| J86A3/4X8 | Chisel, Cold 7/8" |
| J86A7/8X8 | Chisel, Cold 1" |
| J86A1X8 | Chisel, Cold 1-3/16" |
| J9521 | Extractor, Screw 1/8" |
| J9522 | Extractor, Screw 3/16" |
| J9523 | Extractor, Screw 15/64" |
| J9524 | Extractor, Screw 5/16" |
| J9525 | Extractor, Screw 3/8" |
| J9525B | Extractor, Screw 15/32" |
| J9526 | Extractor, Screw 9/16" |
| J9527 | Extractor, Screw 21/32" |
| J9528 | Extractor, Screw 13/16" |
| J9529 | Extractor, Screw 1-1/16" |
| J5260 | Extension, 3/8" DR 3" |
| J5260-06 | Extension, 3/8" DR 6" |
| J5262 | Extension, 3/8" DR 12" |
| J5460 | Extension, 1/2" DR 2-1/2" |
| J5461 | Extension, 1/2" DR 5" |
| J5463 | Extension, 1/2" DR 10" |
| J5660 | Extension, 3/4" DR 4" |
| J5661 | Extension, 3/4" DR 8" |
| J5663 | Extension, 3/4" DR 16" |
| J5268 | Extension, Flex 3/8" DR 8" |
| J5260W | Extension, Wobble 3/8" DR 3" |
| J5260-06W | Extension, Wobble 3/8" DR 6" |
| J5696 | Box, Extra Heavy-Duty Set |
| J95218 | Knife, Folding Blade |
| 15-265 | Hacksaw, 3-7/8" |
| J1430-HB | Hammer Head |
| J1308PD | Hammer, Ball Pein 8 oz. |
| J1316PD | Hammer, Ball Pein 16 oz. |
| J1332PD | Hammer, Ball Pein 32 oz. |
| 57-532 | Hammer, Compo-Cast® 21 oz. |
| 57-534 | Hammer, Compo-Cast® 52 oz. |
| J5265 | Handle, Hinge 3/8" DR 8-1/2" |
| J5468 | Handle, Hinge 1/2" DR |





| Contents | Description |
|-----------------|---|
| J5668 | Handle, Hinge 3/4" DR 20" |
| J5285 | Handle, Sliding T 3/8" DR |
| J5485 | Handle, Sliding T 1/2" DR |
| J5685 | Handle, Sliding T 3/4" DR |
| J5280G | Handle, Speed 3/8" DR |
| J5480G | Handle, Speed 1/2" DR |
| J4980 | Hex Key, 13 PC Standard Set |
| J2108 | Holder, Punch and Chisel |
| J18545B | Knife, Lockback 5" |
| 10-099 | Knife, Stanley® Classic 99® Retractable Blade Utility |
| J1368 | Mallet, Rubber |
| J2373 | Mirror, Rectangular Telescoping 2-1/8" |
| J9206 | Nut Driver, 3/16" |
| J9207 | Nut Driver, 7/32" |
| J9208 | Nut Driver, 1/4" |
| J9209 | Nut Driver, 9/32" |
| J9210 | Nut Driver, 5/16" |
| J9211 | Nut Driver, 11/32" |
| J9212 | Nut Driver, 3/8" |
| J9214 | Nut Driver 7/16" |
| J9216 | Nut Driver, 1/2" |
| J9218 | Nut Driver, 9/16" |
| J9220 | Nut Driver, 5/8" |
| J206G | Pliers, Diagonal Cutting with Grip 6-1/16" |
| J209G | Pliers, Diagonal Cutting with Grip 7-5/16" |
| J227G | Pliers, Duckbill with Grip 7-25/32" |
| J272G | Pliers, End Cutting High Leverage 8-1/4" |
| J268G | Pliers, Lineman's with Grip 8-5/8" |
| J292NC | Pliers, Locking Curved 10" |
| J286LNXL | Pliers, Locking Mini Long Nose 6-29/32" |
| J291NC | Pliers, Locking Straight 7" |
| J225G | Pliers, Needle-Nose Bent Nose 6-5/16" |
| J222G | Pliers, Needle-Nose Long Thin 6-1/16" |
| J226G | Pliers, Needle-Nose with Cutter 6-5/8" |
| J360B | Pliers, 12 PC Set Convertible Retaining Ring |
| J276G | Pliers, Slip-Joint with Grip 6-9/16" |
| J278G | Pliers, Slip-Joint with Grip 8-1/16" |
| J261SG | Pliers, Tongue and Groove 5" with Grip |
| J262SG | Pliers, Tongue and Groove 6-1/2" with Grip |
| J260SG | Pliers, Tongue and Groove 10-3/16" with Grip |
| J265SG | Pliers, Tongue and Groove 16" with Grip |
| J298 | Pliers, Wire Strippers 8-1/4" |
| J2306 | Puller, Cotter Pin Tool |
| J4056-4 | Puller, Jaw Reversible 4 R |
| J4250N | Puller, Nut Adjustable Reversible |
| J4056PN | Puller, Pin Pivot |
| J4205S | Puller, Screw Forcing Acme |
| J4022T | Puller, Tip Detachable Standard |
| J4255B | Puller, Yoke 3 Way Jaw ACM |
| J413/8 | Punch, Center 3/8" |
| J411/2 | Punch, Center 1/2" |
| J965/16 | Punch, Drift 1/8" |
| J963/8 | Punch, Drift 3/16" |
| J961/2 | Punch, Drift 1/4" |
| J471/4X3/32 | Punch, Pin 3/32" |
| J475/16X1/8 | Punch, Pin 1/8" |
| J475/16X5/32 | Punch, Pin 5/32" |
| J473/8X3/16 | Punch, Pin 3/16" |

| Contents | Description |
|-----------------|--|
| J477/16X7/32 | Punch, Pin 7/32" |
| J471/2X1/4 | Punch, Pin 1/4" |
| J445/16 | Punch, Prick 5/16" |
| J501/4 | Punch, Starting 3/32" |
| J505/16 | Punch, Starting 1/8" |
| J503/8 | Punch, Starting 3/16" |
| J501/2 | Punch, Starting 1/4" |
| J507/16 | Punch, Starting 7/32" |
| J5249 | Ratchet, 3/8" DR |
| J5247 | Ratchet Adapter 3/8" DR 2-1/16" |
| J5447 | Ratchet Adapter 1/2" DR 2-21/32" |
| J5449 | Ratchet, 1/2" DR |
| J5450 | Ratchet, 1/2" DR (Long Handle) |
| J5649 | Ratchet, 3/4" DR |
| J5257F | Ratchet, 3/8" DR Flex-Head 2-1/16" |
| J5457F | Ratchet, 1/2" DR Flex-Head 17-3/32" |
| J2375 | Retrieval Tool, Pocket Magnetic |
| 28-540 | Scraper, Flexible 1-1/4" Wood Handle |
| 28-240 | Scraper, Flexible Nylon 1-1/4" |
| J2336 | Scrapers, Gasket and Carbon |
| J9884 | Screw Starter, Phillips® Tip |
| J9853 | Screw Starter, Standard Tip |
| J88203 | Screwdriver, Slotted Cabinet, Round 1/8" x 3" |
| J88204 | Screwdriver, Slotted Cabinet, Round 1/8" x 4" |
| J88208 | Screwdriver, Slotted Cabinet, Round 1/8" x 8" |
| J88214 | Screwdriver, Slotted Cabinet, Round 3/16" x 4" |
| J88218 | Screwdriver, Slotted Cabinet, Round 3/16" x 8" |
| J88393 | Screwdriver, Phillips® #0 |
| J88313 | Screwdriver, Phillips® #1 |
| J88318 | Screwdriver, Phillips® #1 |
| J88322 | Screwdriver, Phillips® #2 |
| J88324 | Screwdriver, Phillips® #2 |
| J88328 | Screwdriver, Phillips® #2 |
| J88336 | Screwdriver, Phillips® #3 |
| J88348 | Screwdriver, Phillips® #4 |
| J88102 | Screwdriver, Slotted Keystone, Square 1/4" x 2" |
| J88104 | Screwdriver, Slotted Keystone, Square 1/4" x 4" |
| J88106 | Screwdriver, Slotted Keystone, Square 1/4" x 6" |
| J88108 | Screwdriver, Slotted Keystone, Square 1/4" x 8" |
| J88112 | Screwdriver, Slotted Keystone, Square 1/4" x 12" |
| J88002 | Screwdriver, Slotted Keystone, Round 1/4" x 1-1/2" |
| J322 | Snips, Straight 12-3/4" |
| J303S | Snips, Aviation Straight |
| J308 | Snips, Miniature |
| J5208S | Socket, 3/8" DR 1/4" 8 PT |
| J5210S | Socket, 3/8" DR 5/16" 8 PT |
| J5212S | Socket, 3/8" DR 3/8" 8 PT |
| J5214S | Socket, 3/8" DR 7/16" 8 PT |
| J5216S | Socket, 3/8" DR 1/2" 8 PT |
| J5208 | Socket, 3/8" DR 1/4" 12 PT |
| J5210 | Socket, 3/8" DR 5/16" 12 PT |
| J5212 | Socket, 3/8" DR 3/8" 12 PT |
| J5214 | Socket, 3/8" DR 7/16" 12 PT |
| J5216 | Socket, 3/8" DR 1/2" 12 PT |
| J5218 | Socket, 3/8" DR 9/16" 12 PT |
| J5220 | Socket, 3/8" DR 5/8" 12 PT |
| J5222 | Socket, 3/8" DR 11/16" 12 PT |
| J5224 | Socket, 3/8" DR 3/4" 12 PT |

(CONTINUED ON NEXT PAGE)

400 PC ADVANCED MAINTENANCE TOOL SET (CONTINUED)

Product #: **J99680**



| Contents | Description | Contents | Description |
|----------|-----------------------------------|-----------|--|
| J5226 | Socket, 3/8" DR 13/16" 12 PT | J5330 | Socket, 1/2" DR 15/16" 12 PT Deep |
| J5228 | Socket, 3/8" DR 7/8" 12 PT | J5332 | Socket, 1/2" DR 1" 12 PT Deep |
| J5230 | Socket, 3/8" DR 15/16" 12 PT | J5334 | Socket, 1/2" DR 1-1/16" 12 PT Deep |
| J5232 | Socket, 3/8" DR 1" 12 PT | J5336 | Socket, 1/2" DR 1-1/8" 12 PT Deep |
| J5008 | Socket, 3/8" DR 1/4" 12 PT Deep | J5340 | Socket, 1/2" DR 1-1/4" 12 PT Deep |
| J5010 | Socket, 3/8" DR 5/16" 12 PT Deep | J5444A | Socket, 1/2" DR Drag Link 3/4" |
| J5012 | Socket, 3/8" DR 3/8" 12 PT Deep | J5446A | Socket, 1/2" DR Drag Link 15/16" |
| J5014 | Socket, 3/8" DR 7/16" 12 PT Deep | J5528 | Socket, 3/4" DR 7/8" 12 PT |
| J5016 | Socket, 3/8" DR 1/2" 12 PT Deep | J5530 | Socket, 3/4" DR 15/16" 12 PT |
| J5018 | Socket, 3/8" DR 9/16" 12 PT Deep | J5532 | Socket, 3/4" DR 1" 12 PT |
| J5020 | Socket, 3/8" DR 5/8" 12 PT Deep | J5534 | Socket, 3/4" DR 1-1/16" 12 PT |
| J5022 | Socket, 3/8" DR 11/16" 12 PT Deep | J5536 | Socket, 3/4" DR 1-1/8" 12 PT |
| J5024 | Socket, 3/8" DR 3/4" 12 PT Deep | J5538 | Socket, 3/4" DR 1-3/16" 12 PT |
| J5026 | Socket, 3/8" DR 13/16" 12 PT Deep | J5540 | Socket, 3/4" DR 1-1/4" 12 PT |
| J5028 | Socket, 3/8" DR 7/8" 12 PT Deep | J5542 | Socket, 3/4" DR 1-5/16" 12 PT |
| J5030 | Socket, 3/8" DR 15/16" 12 PT Deep | J5544 | Socket, 3/4" DR 1-3/8" 12 PT |
| J5032 | Socket, 3/8" DR 1" 12 PT Deep | J5546 | Socket, 3/4" DR 1-7/16" 12 PT |
| J5412S | Socket, 1/2" DR 3/8" 8 PT | J5548 | Socket, 3/4" DR 1-1/2" 12 PT |
| J5414S | Socket, 1/2" DR 7/16" 8 PT | J5550 | Socket, 3/4" DR 1-9/16" 12 PT |
| J5416S | Socket, 1/2" DR 1/2" 8 PT | J5552 | Socket, 3/4" DR 1-5/8" 12 PT |
| J5418S | Socket, 1/2" DR 9/16" 8 PT | J5554 | Socket, 3/4" DR 1-11/16" 12 PT |
| J5420S | Socket, 1/2" DR 5/8" 8 PT | J5556 | Socket, 3/4" DR 1-3/4" 12 PT |
| J5422S | Socket, 1/2" DR 11/16" 8 PT | J5558 | Socket, 3/4" DR 1-13/16" 12 PT |
| J5424S | Socket, 1/2" DR 3/4" 8 PT | J5560 | Socket, 3/4" DR 1-7/8" 12 PT |
| J5426S | Socket, 1/2" DR 13/16" 8 PT | J5564 | Socket, 3/4" DR 2" 12 PT |
| J5428S | Socket, 1/2" DR 7/8" 8 PT | J5568 | Socket, 3/4" DR 2-1/8" 12 PT |
| J5432S | Socket, 1/2" DR 1" 8 PT | J5570 | Socket, 3/4" DR 2-3/16" 12 PT |
| J5419 | Socket, 1/2" DR 19/32" 12 PT | J5572 | Socket, 3/4" DR 2-1/4" 12 PT |
| J5425 | Socket, 1/2" DR 25/32" 12 PT | J5576 | Socket, 3/4" DR 2-3/8" 12 PT |
| J5429 | Socket, 1/2" DR 29/32" 12 PT | J5241 | Socket, Bit 3/8" DR #2 Phillips® |
| J5412 | Socket, 1/2" DR 3/8" 12 PT | J5242 | Socket, Bit 3/8" DR #3 Phillips® |
| J5414 | Socket, 1/2" DR 7/16" 12 PT | J5243 | Socket, Bit 3/8" DR #4 Phillips® |
| J5416 | Socket, 1/2" DR 1/2" 12 PT | J5246 | Socket, Bit 3/8" DR Slotted |
| J5418 | Socket, 1/2" DR 9/16" 12 PT | J49905/32 | Socket, Hex Bit 3/8" DR 5/32" |
| J5420 | Socket, 1/2" DR 5/8" 12 PT | J49903/16 | Socket, Hex Bit 3/8" DR 3/16" |
| J5422 | Socket, 1/2" DR 11/16" 12 PT | J49901/8 | Socket, Hex Bit 3/8" DR 1/8" |
| J5424 | Socket, 1/2" DR 3/4" 12 PT | J49907/32 | Socket, Hex Bit 3/8" DR 7/32" |
| J5426 | Socket, 1/2" DR 13/16" 12 PT | J49905/16 | Socket, Hex Bit 3/8" DR 5/16" |
| J5428 | Socket, 1/2" DR 7/8" 12 PT | J49903/8 | Socket, Hex Bit 3/8" DR 3/8" |
| J5430 | Socket, 1/2" DR 15/16" 12 PT | J49901/4 | Socket, Hex Bit 3/8" DR 1/4" |
| J5432 | Socket, 1/2" DR 1" 12 PT | J54411/4 | Socket, Hex Bit 1/2" DR 1/4" |
| J5434 | Socket, 1/2" DR 1-1/16" 12 PT | J54415/16 | Socket, Hex Bit 1/2" DR 5/16" |
| J5436 | Socket, 1/2" DR 1-1/8" 12 PT | J54413/8 | Socket, Hex Bit 1/2" DR 3/8" |
| J5438 | Socket, 1/2" DR 1-3/16" 12 PT | J54417/16 | Socket, Hex Bit 1/2" DR 7/16" |
| J5440 | Socket, 1/2" DR 1-1/4" 12 PT | J54411/2 | Socket, Hex Bit 1/2" DR 1/2" |
| J5442 | Socket, 1/2" DR 1-5/16" 12 PT | J54419/16 | Socket, Hex Bit 1/2" DR 9/16" |
| J5444 | Socket, 1/2" DR 1-3/8" 12 PT | J54415/8 | Socket, Hex Bit 1/2" DR 5/8" |
| J5446 | Socket, 1/2" DR 1-7/16" 12 PT | J5273A | Socket, Universal 3/8" DR 3/8" 12 PT |
| J5448 | Socket, 1/2" DR 1-1/2" 12 PT | J5274A | Socket, Universal 3/8" DR 7/16" 12 PT |
| J5316 | Socket, 1/2" DR 1/2" 12 PT Deep | J5275A | Socket, Universal 3/8" DR 1/2" 12 PT |
| J5318 | Socket, 1/2" DR 9/16" 12 PT Deep | J5276A | Socket, Universal 3/8" DR 9/16" 12 PT |
| J5320 | Socket, 1/2" DR 5/8" 12 PT Deep | J5277A | Socket, Universal 3/8" DR 5/8" 12 PT |
| J5322 | Socket, 1/2" DR 11/16" 12 PT Deep | J5278A | Socket, Universal 3/8" DR 11/16" 12 PT |
| J5324 | Socket, 1/2" DR 3/4" 12 PT Deep | J5279A | Socket, Universal 3/8" DR 3/4" 12 PT |
| J5326 | Socket, 1/2" DR 13/16" 12 PT Deep | J5475A | Socket, Universal 1/2" DR 1/2" 12 PT |
| J5328 | Socket, 1/2" DR 7/8" 12 PT Deep | J5476A | Socket, Universal 1/2" DR 9/16" 12 PT |





| Contents | Description |
|----------|---|
| J5477A | Socket, Universal 1/2" DR 5/8" 12 PT |
| 33-212 | Tape Rule, Stanley® Powerlock® with Metal Case 1/2" x 12' |
| J708 | Wrench, Adjustable 8" |
| J710 | Wrench, Adjustable 10" |
| J712 | Wrench, Adjustable 12" |
| J715 | Wrench, Adjustable 15" |
| J3314 | Wrench, Angle 7/32" |
| J3315 | Wrench, Angle 15/64" |
| J3316 | Wrench, Angle 1/4" |
| J3318 | Wrench, Angle 9/32" |
| J3320 | Wrench, Angle 5/16" |
| J3324 | Wrench, Angle 3/8" |
| J3322 | Wrench, Angle 11/32" |
| J3328 | Wrench, Angle 7/16" |
| J3332 | Wrench, Angle 1/2" |
| J1170 | Wrench, Box 5/16" x 3/8" 12 PT |
| J1171 | Wrench, Box 7/16" x 1/2" 12 PT |
| J1172 | Wrench, Box 9/16" x 5/8" 12 PT |
| J1173 | Wrench, Box 11/16" x 3/4" 12 PT |
| J1174 | Wrench, Box 13/16" x 7/8" 12 PT |
| J1175 | Wrench, Box 15/16" x 1" 12 PT |
| J1176 | Wrench, Box 1-1/16" x 1-1/8" 12 PT |
| J1120 | Wrench, Box 5/16" x 3/8" 12 PT Short |
| J1122 | Wrench, Box 3/8" x 7/16" 12 PT Short |
| J1126 | Wrench, Box 1/2" x 9/16" 12 PT Short |
| J1131 | Wrench, Box 5/8" x 3/4" 12 PT Short |
| J801 | Wrench, Chain |
| J1210A | Wrench, Combination 5/16" 12 PT |
| J1212ASD | Wrench, Combination 3/8" 12 PT |
| J1214ASD | Wrench, Combination 7/16" 12 PT |
| J1216ASD | Wrench, Combination 1/2" 12 PT |
| J1218ASD | Wrench, Combination 9/16" 12 PT |
| J1220ASD | Wrench, Combination 5/8" 12 PT |
| J1222ASD | Wrench, Combination 11/16" 12 PT |
| J1224ASD | Wrench, Combination 3/4" 12 PT |
| J1226ASD | Wrench, Combination 13/16" 12 PT |
| J1228ASD | Wrench, Combination 7/8" 12 PT |
| J1230ASD | Wrench, Combination 15/16" 12 PT |
| J1232ASD | Wrench, Combination 1" 12 PT |
| J1234ASD | Wrench, Combination 1-1/16" 12 PT |
| J1236ASD | Wrench, Combination 1-1/8" 12 PT |
| J1242 | Wrench, Combination 1-5/16" 12 PT |
| J1244 | Wrench, Combination 1-3/8" 12 PT |
| J1240ASD | Wrench, Combination 1-1/4" 12 PT |
| J1246 | Wrench, Combination 1-7/16" 12 PT |
| J1248 | Wrench, Combination 1-1/2" 12 PT |
| J1204EF | Wrench, Combination 1/8" 6 PT Short |
| J1208EF | Wrench, Combination 1/4" 6 PT Short |
| J1205EF | Wrench, Combination 5/32" 6 PT Short |
| J1206EF | Wrench, Combination 3/16" 6 PT Short |
| J1209EF | Wrench, Combination 9/32" 6 PT Short |
| J1212EF | Wrench, Combination 3/8" 6 PT Short |
| J1211EF | Wrench, Combination 11/32" 6 PT Short |

| Contents | Description |
|----------|--|
| J1210EF | Wrench, Combination 5/16" 6 PT Short |
| J4912CF | Wrench, Crowfoot 3/8" DR 3/8" Open End |
| J4914CF | Wrench, Crowfoot 3/8" DR 7/16" Open End |
| J4916CF | Wrench, Crowfoot 3/8" DR 1/2" Open End |
| J4918CF | Wrench, Crowfoot 3/8" DR 9/16" Open End |
| J4920CF | Wrench, Crowfoot 3/8" DR 5/8" Open End |
| J4922CF | Wrench, Crowfoot 3/8" DR 11/16" Open End |
| J4928CF | Wrench, Crowfoot 3/8" DR 7/8" Open End |
| J4926CF | Wrench, Crowfoot 3/8" DR 13/16" Open End |
| J4924CF | Wrench, Crowfoot 3/8" DR 3/4" Open End |
| J3751 | Wrench, Flare Nut Combination 3/8" 6 PT |
| J3752 | Wrench, Flare Nut Combination 7/16" 6 PT |
| J3753 | Wrench, Flare Nut Combination 1/2" 6 PT |
| J3754 | Wrench, Flare Nut Combination 9/16" 6 PT |
| J3755 | Wrench, Flare Nut Combination 5/8" 6 PT |
| J3756 | Wrench, Flare Nut Combination 11/16" 6 PT |
| J3757 | Wrench, Flare Nut Combination 3/4" 6 PT |
| J3812 | Wrench, Flare Nut Ratcheting 3/8" |
| J3814 | Wrench, Flare Nut Ratcheting 7/16" |
| J3816 | Wrench, Flare Nut Ratcheting 1/2" |
| J3818 | Wrench, Flare Nut Ratcheting 9/16" |
| J3820 | Wrench, Flare Nut Ratcheting 5/8" |
| J3822 | Wrench, Flare Nut Ratcheting 11/16" |
| J3824 | Wrench, Flare Nut Ratcheting 3/4" |
| J1725 | Wrench, Obstruction 7/16" x 1/2" |
| J1730 | Wrench, Obstruction 9/16" x 5/8" |
| J1731 | Wrench, Obstruction 5/8" x 3/4" |
| J3018 | Wrench, Open End 1/4" x 5/16" |
| J3020 | Wrench, Open End 3/8" x 5/16" |
| J3025 | Wrench, Open End 7/16" x 1/2" |
| J3026 | Wrench, Open End 1/2" x 9/16" |
| J3030 | Wrench, Open End 9/16" x 5/8" |
| J3031 | Wrench, Open End 5/8" x 3/4" |
| J3035 | Wrench, Open End 11/16" x 3/4" |
| J3040 | Wrench, Open End 13/16" x 7/8" |
| J3045 | Wrench, Open End 15/16" x 1" |
| J3050 | Wrench, Open End 1-1/16" x 1-1/8" |
| J810HD | Wrench, Pipe Heavy-Duty 10" |
| J814HD | Wrench, Pipe Heavy-Duty 14" |
| J818HD | Wrench, Pipe Heavy-Duty 18" |
| J1191T-A | Wrench, Ratcheting Box 1/4" x 5/16" 12 PT |
| J1192T-A | Wrench, Ratcheting Box 3/8" x 7/16" 12 PT |
| J1193T-A | Wrench, Ratcheting Box 1/2" x 9/16" 12 PT |
| J1194-A | Wrench, Ratcheting Box 5/8" x 11/16" 12 PT |
| J1195-A | Wrench, Ratcheting Box 3/4" x 7/8" 12 PT |
| J1270-12 | Wrench, Swivel Combination 3/8" 12 PT |
| J1270-14 | Wrench, Swivel Combination 7/16" 12 PT |
| J1270-16 | Wrench, Swivel Combination 1/2" 12 PT |
| J1270-18 | Wrench, Swivel Combination 9/16" 12 PT |
| J1270-20 | Wrench, Swivel Combination 5/8" 12 PT |
| J1270-22 | Wrench, Swivel Combination 11/16" 12 PT |
| J1270-24 | Wrench, Swivel Combination 3/4" 12 PT |
| J6014C | Wrench, Torque 1/2" DR 50-250 ft-lbs |

400 PC ADVANCE MAINTENANCE SET WITH ROLLER CABINET J442742-8RD AND TOP CHEST J442719-12RD-D

Product #: J99681

- › 400 Pieces.
- › 3/8", 1/2", 3/4" Drive Tools.
- › Designed for fastener sizes 1/8" - 2-3/8".
- › Contains: 158 Sockets and Accessories, 104 Wrenches, 38 Striking and Struck Tools, 30 Pliers, 21 Screwdrivers, 49 Miscellaneous Tools.
- › Sub-sets contained: J99660, J99665, J99675.
- › Weight: 640.0 lbs.



Representative Image; Contents May Differ



400 PC ADVANCED MAINTENANCE SET WITH ROLLER CABINET J453441-8RD AND TOP CHEST J453427-6RD

Product #: J99682

- › 411 Pieces.
- › 1/4", 3/8", 1/2" Drive Tools.
- › Designed for fastener sizes 1/8" - 1-7/16".
- › Contains: 183 Sockets and Accessories, 99 Wrenches, 31 Striking and Struck Tools, 26 Pliers, 21 Screwdrivers, 51 Miscellaneous Tools.
- › Sub-sets contained: J99810, J99825, J99835.
- › Weight: 624.0 lbs.



Representative Image; Contents May Differ



271 PC ADVANCED MAINTENANCE TOOL SET

Product #: J99910

- › 271 Pieces.
- › 1/4", 3/8" Drive Tools.
- › Designed for fastener sizes 1/16" - 1-1/4", 2.5 mm - 24 mm.
- › Contains: 176 Sockets and Accessories, 57 Wrenches, 3 Striking and Struck Tools, 5 Pliers, 30 Screwdrivers.
- › Sub-sets contained: J99900, J99905.
- › Weight: 297.1 lbs.



Representative Image; Contents May Differ

| Contents | Description |
|----------|--|
| J4770A | Adapter, Universal Joint 1/4" DR |
| J5270A | Adapter, Universal Joint 3/8" DR |
| J4769 | Driver, 1/4" DR |
| J4759 | Extension, 1/4" DR 2" |
| J4760 | Extension, 1/4" DR 3" |
| J4761 | Extension, 1/4" DR 6" |
| J5260 | Extension, 3/8" DR 3" |
| J5260-06 | Extension, 3/8" DR 6" |
| J5262 | Extension, 3/8" DR 12" |
| J4765 | Extension, Flex 1/4" DR 6-1/4" |
| J5268 | Extension, Flex 3/8" DR 8" |
| J1308PD | Hammer, Ball Pein 8 oz. |
| J1316PD | Hammer, Ball Pein 16 oz. |
| J4766 | Handle, Hinge 1/4" DR 5-3/4" |
| J5265 | Handle, Hinge 3/8" DR 8-1/2" |
| J4785 | Handle, Sliding T 1/4" DR |
| J5285 | Handle, Sliding T 3/8" DR |
| J5280G | Handle, Speed 3/8" DR |
| J1368 | Mallet, Rubber |
| J9206 | Nut Driver, 3/16" |
| J9207 | Nut Driver, 7/32" |
| J9208 | Nut Driver, 1/4" |
| J9209 | Nut Driver, 9/32" |
| J9210 | Nut Driver, 5/16" |
| J9211 | Nut Driver, 11/32" |
| J9212 | Nut Driver, 3/8" |
| J9214 | Nut Driver 7/16" |
| J9216 | Nut Driver, 1/2" |
| J9218 | Nut Driver, 9/16" |
| J9220 | Nut Driver, 5/8" |
| J206G | Pliers, Diagonal Cutting with Grip 6-1/16" |
| J291NC | Pliers, Locking Straight 7" |
| J222G | Pliers, Needle-Nose Long Thin 6-1/16" |
| J276G | Pliers, Slip-Joint with Grip 6-9/16" |
| J278G | Pliers, Slip-Joint with Grip 8-1/16" |
| J4749 | Ratchet, 1/4" DR |
| J5249 | Ratchet, 3/8" DR |
| J5247 | Ratchet Adapter 3/8" DR 2-1/16" |
| J5257F | Ratchet, 3/8" DR Flex-Head 2-1/16" |
| J88203 | Screwdriver, Slotted Cabinet, Round 1/8" x 3" |
| J88204 | Screwdriver, Slotted Cabinet, Round 1/8" x 4" |
| J88208 | Screwdriver, Slotted Cabinet, Round 1/8" x 8" |
| J88214 | Screwdriver, Slotted Cabinet, Round 3/16" x 4" |
| J88218 | Screwdriver, Slotted Cabinet, Round 3/16" x 8" |
| J88393 | Screwdriver, Phillips® #0 |
| J88313 | Screwdriver, Phillips® #1 |
| J88318 | Screwdriver, Phillips® #1 |
| J88322 | Screwdriver, Phillips® #2 |
| J88324 | Screwdriver, Phillips® #2 |
| J88328 | Screwdriver, Phillips® #2 |

(CONTINUED ON NEXT PAGE)



271 PC ADVANCED MAINTENANCE TOOL SET (CONTINUED)

Product #: **J99910**



| Contents | Description | Contents | Description |
|----------|--|----------|-----------------------------------|
| J88336 | Screwdriver, Phillips® #3 | J5210S | Socket, 3/8" DR 5/16" 8 PT |
| J88348 | Screwdriver, Phillips® #4 | J5212S | Socket, 3/8" DR 3/8" 8 PT |
| J88102 | Screwdriver, Slotted Keystone, Square 1/4" x 2" | J5214S | Socket, 3/8" DR 7/16" 8 PT |
| J88104 | Screwdriver, Slotted Keystone, Square 1/4" x 4" | J5216S | Socket, 3/8" DR 1/2" 8 PT |
| J88106 | Screwdriver, Slotted Keystone, Square 1/4" x 6" | J5208 | Socket, 3/8" DR 1/4" 12 PT |
| J88108 | Screwdriver, Slotted Keystone, Square 1/4" x 8" | J5210 | Socket, 3/8" DR 5/16" 12 PT |
| J88112 | Screwdriver, Slotted Keystone, Square 1/4" x 12" | J5212 | Socket, 3/8" DR 3/8" 12 PT |
| J88002 | Screwdriver, Slotted Keystone, Round 1/4" x 1-1/2" | J5214 | Socket, 3/8" DR 7/16" 12 PT |
| J4706 | Socket, 1/4" DR 3/16" 6 PT | J5216 | Socket, 3/8" DR 1/2" 12 PT |
| J4707 | Socket, 1/4" DR 7/32" 6 PT | J5218 | Socket, 3/8" DR 9/16" 12 PT |
| J4708 | Socket, 1/4" DR 1/4" 6 PT | J5220 | Socket, 3/8" DR 5/8" 12 PT |
| J4709 | Socket, 1/4" DR 9/32" 6 PT | J5222 | Socket, 3/8" DR 11/16" 12 PT |
| J4710 | Socket, 1/4" DR 5/16" 6 PT | J5224 | Socket, 3/8" DR 3/4" 12 PT |
| J4711 | Socket, 1/4" DR 11/32" 6 PT | J5226 | Socket, 3/8" DR 13/16" 12 PT |
| J4712 | Socket, 1/4" DR 3/8" 6 PT | J5228 | Socket, 3/8" DR 7/8" 12 PT |
| J4714 | Socket, 1/4" DR 7/16" 6 PT | J5230 | Socket, 3/8" DR 15/16" 12 PT |
| J4716 | Socket, 1/4" DR 1/2" 6 PT | J5232 | Socket, 3/8" DR 1" 12 PT |
| J4718 | Socket, 1/4" DR 9/16" 6 PT | J5208M | Socket, 3/8" DR 8 mm 12 PT |
| J4704M | Socket, 1/4" DR 4 mm 6 PT | J5209M | Socket, 3/8" DR 9 mm 12 PT |
| J4705M | Socket, 1/4" DR 5 mm 6 PT | J5210M | Socket, 3/8" DR 10 mm 12 PT |
| J47055M | Socket, 1/4" DR 5.5 mm 6 PT | J5211M | Socket, 3/8" DR 11 mm 12 PT |
| J4706M | Socket, 1/4" DR 6 mm 6 PT | J5212M | Socket, 3/8" DR 12 mm 12 PT |
| J4707M | Socket, 1/4" DR 7 mm 6 PT | J5213M | Socket, 3/8" DR 13 mm 12 PT |
| J4708M | Socket, 1/4" DR 8 mm 6 PT | J5214M | Socket, 3/8" DR 14 mm 12 PT |
| J4709M | Socket, 1/4" DR 9 mm 6 PT | J5215M | Socket, 3/8" DR 15 mm 12 PT |
| J4710M | Socket, 1/4" DR 10 mm 6 PT | J5216M | Socket, 3/8" DR 16 mm 12 PT |
| J4711M | Socket, 1/4" DR 11 mm 6 PT | J5217M | Socket, 3/8" DR 17 mm 12 PT |
| J4712M | Socket, 1/4" DR 12 mm 6 PT | J5218M | Socket, 3/8" DR 18 mm 12 PT |
| J4713M | Socket, 1/4" DR 13 mm 6 PT | J5219M | Socket, 3/8" DR 19 mm 12 PT |
| J4714M | Socket, 1/4" DR 14 mm 6 PT | J5008 | Socket, 3/8" DR 1/4" 12 PT Deep |
| J4706L | Socket, 1/4" DR 3/16" 6 PT Deep | J5010 | Socket, 3/8" DR 5/16" 12 PT Deep |
| J4707L | Socket, 1/4" DR 7/32" 6 PT Deep | J5012 | Socket, 3/8" DR 3/8" 12 PT Deep |
| J4708L | Socket, 1/4" DR 1/4" 6 PT Deep | J5014 | Socket, 3/8" DR 7/16" 12 PT Deep |
| J4709L | Socket, 1/4" DR 9/32" 6 PT Deep | J5016 | Socket, 3/8" DR 1/2" 12 PT Deep |
| J4710L | Socket, 1/4" DR 5/16" 6 PT Deep | J5018 | Socket, 3/8" DR 9/16" 12 PT Deep |
| J4711L | Socket, 1/4" DR 11/32" 6 PT Deep | J5020 | Socket, 3/8" DR 5/8" 12 PT Deep |
| J4712L | Socket, 1/4" DR 3/8" 6 PT Deep | J5022 | Socket, 3/8" DR 11/16" 12 PT Deep |
| J4714L | Socket, 1/4" DR 7/16" 6 PT Deep | J5024 | Socket, 3/8" DR 3/4" 12 PT Deep |
| J4716L | Socket, 1/4" DR 1/2" 6 PT Deep | J5026 | Socket, 3/8" DR 13/16" 12 PT Deep |
| J4718L | Socket, 1/4" DR 9/16" 6 PT Deep | J5028 | Socket, 3/8" DR 7/8" 12 PT Deep |
| J4704LM | Socket, 1/4" DR 4 mm 6 PT Deep | J5030 | Socket, 3/8" DR 15/16" 12 PT Deep |
| J4705LM | Socket, 1/4" DR 5 mm 6 PT Deep | J5032 | Socket, 3/8" DR 1" 12 PT Deep |
| J47055LM | Socket, 1/4" DR 5.5 mm 6 PT Deep | J5008M | Socket, 3/8" DR 8 mm 12 PT Deep |
| J4706LM | Socket, 1/4" DR 6 mm 6 PT Deep | J5009M | Socket, 3/8" DR 9 mm 12 PT Deep |
| J4707LM | Socket, 1/4" DR 7 mm 6 PT Deep | J5010M | Socket, 3/8" DR 10 mm 12 PT Deep |
| J4708LM | Socket, 1/4" DR 8 mm 6 PT Deep | J5011M | Socket, 3/8" DR 11 mm 12 PT Deep |
| J4709LM | Socket, 1/4" DR 9 mm 6 PT Deep | J5012M | Socket, 3/8" DR 12 mm 12 PT Deep |
| J4710LM | Socket, 1/4" DR 10 mm 6 PT Deep | J5013M | Socket, 3/8" DR 13 mm 12 PT Deep |
| J4711LM | Socket, 1/4" DR 11 mm 6 PT Deep | J5014M | Socket, 3/8" DR 14 mm 12 PT Deep |
| J4712LM | Socket, 1/4" DR 12 mm 6 PT Deep | J5015M | Socket, 3/8" DR 15 mm 12 PT Deep |
| J4713LM | Socket, 1/4" DR 13 mm 6 PT Deep | J5016M | Socket, 3/8" DR 16 mm 12 PT Deep |
| J4714LM | Socket, 1/4" DR 14 mm 6 PT Deep | J5017M | Socket, 3/8" DR 17 mm 12 PT Deep |
| J4710S | Socket, 1/4" DR 5/16" 8 PT | J5018M | Socket, 3/8" DR 18 mm 12 PT Deep |
| J4712S | Socket, 1/4" DR 3/8" 8 PT | J5019M | Socket, 3/8" DR 19 mm 12 PT Deep |
| J4708S | Socket, 1/4" DR 1/4" 8 PT | J4744 | Socket, Bit 1/4" DR Slotted 3/16" |
| J5208S | Socket, 3/8" DR 1/4" 8 PT | | |





| Contents | Description |
|------------|---|
| J4737 | Socket, Bit 1/4" DR #1 Phillips® |
| J4738 | Socket, Bit 1/4" DR #2 Phillips® |
| J4743 | Socket, Bit 1/4" DR Slotted 1/4" 1-3/16" |
| J4745 | Socket, Bit 1/4" DR Slotted 1/4" 1-13/64" |
| J5241 | Socket, Bit 3/8" DR #2 Phillips® |
| J5242 | Socket, Bit 3/8" DR #3 Phillips® |
| J5243 | Socket, Bit 3/8" DR #4 Phillips® |
| J5246 | Socket, Bit 3/8" DR Slotted |
| J47701/16 | Socket, Hex Bit 1/4" DR 1/16" |
| J47705/64 | Socket, Hex Bit 1/4" DR 5/64" |
| J47703/32 | Socket, Hex Bit 1/4" DR 3/32" |
| J47707/64 | Socket, Hex Bit 1/4" DR 7/64" |
| J47701/8 | Socket, Hex Bit 1/4" DR 1/8" |
| J47709/64 | Socket, Hex Bit 1/4" DR 9/64" |
| J47705/32 | Socket, Hex Bit 1/4" DR 5/32" |
| J47703/16 | Socket, Hex Bit 1/4" DR 3/16" |
| J47707/32 | Socket, Hex Bit 1/4" DR 7/32" |
| J47701/4 | Socket, Hex Bit 1/4" DR 1/4" |
| J47705/16 | Socket, Hex Bit 1/4" DR 5/16" |
| J4770-2M | Socket, Hex Bit 1/4" DR 2 mm |
| J4770-2.5M | Socket, Hex Bit 1/4" DR 2.5 mm |
| J4770-3M | Socket, Hex Bit 1/4" DR 3 mm |
| J4770-4M | Socket, Hex Bit 1/4" DR 4 mm |
| J4770-5M | Socket, Hex Bit 1/4" DR 5 mm |
| J4770-6M | Socket, Hex Bit 1/4" DR 6 mm |
| J49901/8 | Socket, Hex Bit 3/8" DR 1/8" |
| J49905/32 | Socket, Hex Bit 3/8" DR 5/32" |
| J49903/16 | Socket, Hex Bit 3/8" DR 3/16" |
| J49907/32 | Socket, Hex Bit 3/8" DR 7/32" |
| J49901/4 | Socket, Hex Bit 3/8" DR 1/4" |
| J49905/16 | Socket, Hex Bit 3/8" DR 5/16" |
| J49903/8 | Socket, Hex Bit 3/8" DR 3/8" |
| J4990-4M | Socket, Hex Bit 3/8" DR 4 mm |
| J4990-5M | Socket, Hex Bit 3/8" DR 5 mm |
| J4990-6M | Socket, Hex Bit 3/8" DR 6 mm |
| J4990-7M | Socket, Hex Bit 3/8" DR 7 mm |
| J4990-8M | Socket, Hex Bit 3/8" DR 8 mm |
| J4990-9M | Socket, Hex Bit 3/8" DR 9 mm |
| J4990-10M | Socket, Hex Bit 3/8" DR 10 mm |
| J5441-12M | Socket, Hex Bit 1/2" DR 12 mm |
| J5441-14M | Socket, Hex Bit 1/2" DR 14 mm |
| J5441-17M | Socket, Hex Bit 1/2" DR 17 mm |
| J4771TA | Socket, Universal 1/4" DR 1/4" 12 PT |
| J4772TA | Socket, Universal 1/4" DR 5/16 12 PT |
| J4773TA | Socket, Universal 1/4" DR 3/8" 12 PT |
| J4774TA | Socket, Universal 1/4" DR 7/16 12 PT |
| J5273A | Socket, Universal 3/8" DR 3/8" 12 PT |
| J5274A | Socket, Universal 3/8" DR 7/16" 12 PT |
| J5275A | Socket, Universal 3/8" DR 1/2" 12 PT |
| J5276A | Socket, Universal 3/8" DR 9/16" 12 PT |
| J5277A | Socket, Universal 3/8" DR 5/8" 12 PT |
| J5278A | Socket, Universal 3/8" DR 11/16" 12 PT |
| J5279A | Socket, Universal 3/8" DR 3/4" 12 PT |
| J706 | Wrench, Adjustable 6" |
| J708 | Wrench, Adjustable 8" |

| Contents | Description |
|-----------|-----------------------------------|
| J710 | Wrench, Adjustable 10" |
| J1210A | Wrench, Combination 5/16" 12 PT |
| J1212ASD | Wrench, Combination 3/8" 12 PT |
| J1214ASD | Wrench, Combination 7/16" 12 PT |
| J1216ASD | Wrench, Combination 1/2" 12 PT |
| J1218ASD | Wrench, Combination 9/16" 12 PT |
| J1220ASD | Wrench, Combination 5/8" 12 PT |
| J1222ASD | Wrench, Combination 11/16" 12 PT |
| J1228ASD | Wrench, Combination 7/8" 12 PT |
| J1226ASD | Wrench, Combination 13/16" 12 PT |
| J1224ASD | Wrench, Combination 3/4" 12 PT |
| J1230ASD | Wrench, Combination 15/16" 12 PT |
| J1232ASD | Wrench, Combination 1" 12 PT |
| J1234ASD | Wrench, Combination 1-1/16" 12 PT |
| J1236ASD | Wrench, Combination 1-1/8" 12 PT |
| J1240ASD | Wrench, Combination 1-1/4" 12 PT |
| J1207MA | Wrench, Combination 7 mm 12 PT |
| J1208MA | Wrench, Combination 8 mm 12 PT |
| J1209MA | Wrench, Combination 9 mm 12 PT |
| J1210MASD | Wrench, Combination 10 mm 12 PT |
| J1211MASD | Wrench, Combination 11 mm 12 PT |
| J1212MASD | Wrench, Combination 12 mm 12 PT |
| J1213MASD | Wrench, Combination 13 mm 12 PT |
| J1214MASD | Wrench, Combination 14 mm 12 PT |
| J1215MASD | Wrench, Combination 15 mm 12 PT |
| J1216MASD | Wrench, Combination 16 mm 12 PT |
| J1217MASD | Wrench, Combination 17 mm 12 PT |
| J1218MASD | Wrench, Combination 18 mm 12 PT |
| J1219MASD | Wrench, Combination 19 mm 12 PT |
| J1220MASD | Wrench, Combination 20 mm 12 PT |
| J1221MASD | Wrench, Combination 21 mm 12 PT |
| J1222MASD | Wrench, Combination 22 mm 12 PT |
| J1223MASD | Wrench, Combination 23 mm 12 PT |
| J1224MASD | Wrench, Combination 24 mm 12 PT |
| J3018 | Wrench, Open End 1/4" x 5/16" |
| J3020 | Wrench, Open End 3/8" x 5/16" |
| J3025 | Wrench, Open End 7/16" x 1/2" |
| J3026 | Wrench, Open End 1/2" x 9/16" |
| J3030 | Wrench, Open End 9/16" x 5/8" |
| J3031 | Wrench, Open End 5/8" x 3/4" |
| J3035 | Wrench, Open End 11/16" x 3/4" |
| J3040 | Wrench, Open End 13/16" x 7/8" |
| J3045 | Wrench, Open End 15/16" x 1" |
| J3050 | Wrench, Open End 1-1/16" x 1-1/8" |
| J30607 | Wrench, Open End 6 mm x 7 mm |
| J30809 | Wrench, Open End 8 mm x 9 mm |
| J31011 | Wrench, Open End 10 mm x 11 mm |
| J31213 | Wrench, Open End 12 mm x 13 mm |
| J31415 | Wrench, Open End 14 mm x 15 mm |
| J31617 | Wrench, Open End 16 mm x 17 mm |
| J31819 | Wrench, Open End 18 mm x 19 mm |
| J32022 | Wrench, Open End 20 mm x 22 mm |
| J32123 | Wrench, Open End 21 mm x 23 mm |
| J32426 | Wrench, Open End 24 mm x 26 mm |
| J810HD | Wrench, Pipe Heavy-Duty 10" |

271 PC ADVANCED MAINTENANCE SET WITH ROLLER CABINET J442742-8RD

Product #: J99911



- › 271 Pieces.
- › 1/4", 3/8" Drive Tools.
- › Designed for fastener sizes 1/16" - 1-1/4", 2.5 mm - 24 mm.
- › Contains: 176 Sockets and Accessories, 57 Wrenches, 3 Striking and Struck Tools, 5 Pliers, 19 Screwdrivers, 11 Miscellaneous Tools.
- › Sub-sets contained: J99900, J99905.
- › Weight: 484.0 lbs.



Representative Image; Contents May Differ

271 PC ADVANCED MAINTENANCE SET WITH ROLLER CABINET J453441-8RD

Product #: J99912



- › 271 Pieces.
- › 1/4", 3/8" Drive Tools.
- › Designed for fastener sizes 1/16" - 1-1/4", 2.5 mm - 24 mm.
- › Contains: 176 Sockets and Accessories, 57 Wrenches, 3 Striking and Struck Tools, 5 Pliers, 19 Screwdrivers, 11 Miscellaneous Tools.
- › Sub-sets contained: J99900, J99905.
- › Weight: 606.0 lbs.



Representative Image; Contents May Differ



334 PC MASTER ADVANCED MAINTENANCE SET

Product #: JCS-0334MAS



- › 334 Pieces.
- › 1/4", 3/8", 1/2" Drive Tools.
- › Designed for fastener sizes 1/16" - 1-1/2", 9 mm - 19 mm.
- › Tools only.
- › Contains: 193 Sockets and Accessories, 44 Wrenches, 30 Striking and Struck Tools, 15 Pliers, 30 Screwdrivers, 22 Miscellaneous Tools.
- › Enhanced version of Proto® J99670 Advanced Maintenance Set.
- › Weight: 115.0 lbs.



Representative Image; Contents May Differ

(CONTINUED ON NEXT PAGE)

Made in USA accurate at time of printing, consult www.protoindustrial.com for updated information.

Made in USA

Made in USA with global components

PROTO



334 PC MASTER ADVANCED MAINTENANCE SET (CONTINUED)

Product #: JCS-0334MAS



| Contents | Description | Contents | Description |
|-----------|---|--------------|--|
| J4770A | Adapter, Universal Joint 1/4" DR | J268G | Pliers, Lineman's with Grip 8-5/8" |
| J5270A | Adapter, Universal Joint 3/8" DR | J225G | Pliers, Needle-Nose Bent Nose 6-5/16" |
| J5470A | Adapter, Universal Joint 1/2" DR | J222G | Pliers, Needle-Nose Long Thin 6-1/16" |
| J86A3/16 | Chisel, Cold 1/4" | J276G | Pliers, Slip-Joint with Grip 6-9/16" |
| J86A1/4 | Chisel, Cold 5/16" | J278G | Pliers, Slip-Joint with Grip 8-1/16" |
| J86A5/16 | Chisel, Cold 3/8" | J413/8 | Punch, Center 3/8" |
| J86A7/16 | Chisel, Cold 1/2" | J411/2 | Punch, Center 1/2" |
| J86A1/2 | Chisel, Cold 5/8" | J965/16 | Punch, Drift 1/8" |
| J86A5/8 | Chisel, Cold 3/4" | J963/8 | Punch, Drift 3/16" |
| J86A3/4X8 | Chisel, Cold 7/8" | J961/2 | Punch, Drift 1/4" |
| J86A7/8X8 | Chisel, Cold 1" | J471/4X3/32 | Punch, Pin 3/32" |
| J86A1X8 | Chisel, Cold 1-3/16" | J475/16X1/8 | Punch, Pin 1/8" |
| J4769 | Driver, 1/4" DR | J475/16X5/32 | Punch, Pin 5/32" |
| J4759 | Extension, 1/4" DR 2" | J473/8X3/16 | Punch, Pin 3/16" |
| J4760 | Extension, 1/4" DR 3" | J477/16X7/32 | Punch, Pin 7/32" |
| J4761 | Extension, 1/4" DR 6" | J471/2X1/4 | Punch, Pin 1/4" |
| J5260 | Extension, 3/8" DR 3" | J445/16 | Punch, Prick 5/16" |
| J5260-06 | Extension, 3/8" DR 6" | J501/4 | Punch, Starting 3/32" |
| J5262 | Extension, 3/8" DR 12" | J505/16 | Punch, Starting 1/8" |
| J5461 | Extension, 1/2" DR 5" | J503/8 | Punch, Starting 3/16" |
| J5460 | Extension, 1/2" DR 2-1/2" | J507/16 | Punch, Starting 7/32" |
| J5463 | Extension, 1/2" DR 10" | J501/2 | Punch, Starting 1/4" |
| J4765 | Extension, Flex 1/4" DR 6-1/4" | J5247 | Ratchet Adapter 3/8" DR 2-1/16" |
| J5268 | Extension, Flex 3/8" DR 8" | J5447 | Ratchet Adapter 1/2" DR 2-21/32" |
| J95218 | Knife, Folding Blade | J4749 | Ratchet, 1/4" DR Standard Length Premium Pear Handle |
| 15-265 | Hacksaw, 3-7/8" | J5450 | Ratchet, 1/2" DR (Long Handle) |
| J1308PD | Hammer, Ball Pein 8 oz. | J5249XL | Ratchet, 3/8" DR Standard Length Premium Pear Head |
| J1316PD | Hammer, Ball Pein 16 oz. | J5449XL | Ratchet, 1/2" DR Standard Length Premium Pear Head |
| J5468 | Handle, Hinge 1/2" DR | J88203 | Screwdriver, Slotted Cabinet, Round 1/8" x 3" |
| J4766 | Handle, Hinge 1/4" DR 5-3/4" | J88204 | Screwdriver, Slotted Cabinet, Round 1/8" x 4" |
| J5265 | Handle, Hinge 3/8" DR 8-1/2" | J88208 | Screwdriver, Slotted Cabinet, Round 1/8" x 8" |
| J4785 | Handle, Sliding T 1/4" DR | J88214 | Screwdriver, Slotted Cabinet, Round 3/16" x 4" |
| J5285 | Handle, Sliding T 3/8" DR | J88218 | Screwdriver, Slotted Cabinet, Round 3/16" x 8" |
| J5485 | Handle, Sliding T 1/2" DR | J88393 | Screwdriver, Phillips® #0 |
| J5280G | Handle, Speed 3/8" DR | J88313 | Screwdriver, Phillips® #1 |
| J5480G | Handle, Speed 1/2" DR | J88318 | Screwdriver, Phillips® #1 |
| J2108 | Holder, Punch and Chisel | J88322 | Screwdriver, Phillips® #2 |
| J18545B | Knife, Lockback 5" | J88324 | Screwdriver, Phillips® #2 |
| 10-099 | Knife, Stanley® Classic 99® Retractable Blade Utility | J88328 | Screwdriver, Phillips® #2 |
| J1368 | Mallet, Rubber | J88336 | Screwdriver, Phillips® #3 |
| J9206 | Nut Driver, 3/16" | J88348 | Screwdriver, Phillips® #4 |
| J9207 | Nut Driver, 7/32" | J88102 | Screwdriver, Slotted Keystone, Square 1/4" x 2" |
| J9208 | Nut Driver, 1/4" | J88104 | Screwdriver, Slotted Keystone, Square 1/4" x 4" |
| J9209 | Nut Driver, 9/32" | J88106 | Screwdriver, Slotted Keystone, Square 1/4" x 6" |
| J9210 | Nut Driver, 5/16" | J88108 | Screwdriver, Slotted Keystone, Square 1/4" x 8" |
| J9211 | Nut Driver, 11/32" | J88112 | Screwdriver, Slotted Keystone, Square 1/4" x 12" |
| J9212 | Nut Driver, 3/8" | J88002 | Screwdriver, Slotted Keystone, Round 1/4" x 1-1/2" |
| J9214 | Nut Driver, 7/16" | J4980 | Hex Key, 13 PC Standard Set |
| J9216 | Nut Driver, 1/2" | J4707 | Socket, 1/4" DR 7/32" 6 PT |
| J9218 | Nut Driver, 9/16" | J4706 | Socket, 1/4" DR 3/16" 6 PT |
| J9220 | Nut Driver, 5/8" | J4709 | Socket, 1/4" DR 9/32" 6 PT |
| J2806SMP | Pliers, 6 PC Mini Set | J4708 | Socket, 1/4" DR 1/4" 6 PT |
| J291NC | Pliers, Locking Straight 7" | J4710 | Socket, 1/4" DR 5/16" 6 PT |
| J206G | Pliers, Diagonal Cutting with Grip 6-1/16" | J4711 | Socket, 1/4" DR 11/32" 6 PT |
| J209G | Pliers, Diagonal Cutting with Grip 7-5/16" | | |
| J272G | Pliers, End Cutting High Leverage 8-1/4" | | |





| Contents | Description |
|-----------------|---|
| J4712 | Socket, 1/4" DR 3/8" 6 PT |
| J4714 | Socket, 1/4" DR 7/16" 6 PT |
| J4716 | Socket, 1/4" DR 1/2" 6 PT |
| J4718 | Socket, 1/4" DR 9/16" 6 PT |
| J4707L | Socket, 1/4" DR 7/32" 6 PT Deep |
| J4706L | Socket, 1/4" DR 3/16" 6 PT Deep |
| J4709L | Socket, 1/4" DR 9/32" 6 PT Deep |
| J4708L | Socket, 1/4" DR 1/4" 6 PT Deep |
| J4710L | Socket, 1/4" DR 5/16" 6 PT Deep |
| J4711L | Socket, 1/4" DR 11/32" 6 PT Deep |
| J4712L | Socket, 1/4" DR 3/8" 6 PT Deep |
| J4714L | Socket, 1/4" DR 7/16" 6 PT Deep |
| J4716L | Socket, 1/4" DR 1/2" 6 PT Deep |
| J4718L | Socket, 1/4" DR 9/16" 6 PT Deep |
| J4708S | Socket, 1/4" DR 1/4" 8 PT |
| J4710S | Socket, 1/4" DR 5/16" 8 PT |
| J4712S | Socket, 1/4" DR 3/8" 8 PT |
| J5206HS | Socket, 3/8" DR 3/16" 6 PT Super Short |
| J5208HS | Socket, 3/8" DR 1/4" 6 PT Super Short |
| J5210HS | Socket, 3/8" DR 5/16" 6 PT Super Short |
| J5212HS | Socket, 3/8" DR 3/8" 6 PT Super Short |
| J5214HS | Socket, 3/8" DR 7/16" 6 PT Super Short |
| J5216HS | Socket, 3/8" DR 1/2" 6 PT Super Short |
| J5218HS | Socket, 3/8" DR 9/16" 6 PT Super Short |
| J5220HS | Socket, 3/8" DR 5/8" 6 PT Super Short |
| J5222HS | Socket, 3/8" DR 11/16" 6 PT Super Short |
| J5224HS | Socket, 3/8" DR 3/4" 6 PT Super Short |
| J5209MHS | Socket, 3/8" DR 9 mm 6 PT Super Short |
| J5210MHS | Socket, 3/8" DR 10 mm 6 PT Super Short |
| J5211MHS | Socket, 3/8" DR 11 mm 6 PT Super Short |
| J5212MHS | Socket, 3/8" DR 12 mm 6 PT Super Short |
| J5213MHS | Socket, 3/8" DR 13 mm 6 PT Super Short |
| J5214MHS | Socket, 3/8" DR 14 mm 6 PT Super Short |
| J5215MHS | Socket, 3/8" DR 15 mm 6 PT Super Short |
| J5216MHS | Socket, 3/8" DR 16 mm 6 PT Super Short |
| J5217MHS | Socket, 3/8" DR 17 mm 6 PT Super Short |
| J5218MHS | Socket, 3/8" DR 18 mm 6 PT Super Short |
| J5219MHS | Socket, 3/8" DR 19 mm 6 PT Super Short |
| J5208S | Socket, 3/8" DR 1/4" 8 PT |
| J5210S | Socket, 3/8" DR 5/16" 8 PT |
| J5212S | Socket, 3/8" DR 3/8" 8 PT |
| J5214S | Socket, 3/8" DR 7/16" 8 PT |
| J5216S | Socket, 3/8" DR 1/2" 8 PT |
| J5210 | Socket, 3/8" DR 5/16" 12 PT |
| J5212 | Socket, 3/8" DR 3/8" 12 PT |
| J5208 | Socket, 3/8" DR 1/4" 12 PT |
| J5214 | Socket, 3/8" DR 7/16" 12 PT |
| J5216 | Socket, 3/8" DR 1/2" 12 PT |
| J5218 | Socket, 3/8" DR 9/16" 12 PT |
| J5220 | Socket, 3/8" DR 5/8" 12 PT |
| J5222 | Socket, 3/8" DR 11/16" 12 PT |
| J5224 | Socket, 3/8" DR 3/4" 12 PT |
| J5226 | Socket, 3/8" DR 13/16" 12 PT |
| J5228 | Socket, 3/8" DR 7/8" 12 PT |
| J5230 | Socket, 3/8" DR 15/16" 12 PT |
| J5232 | Socket, 3/8" DR 1" 12 PT |
| J5008 | Socket, 3/8" DR 1/4" 12 PT Deep |
| J5010 | Socket, 3/8" DR 5/16" 12 PT Deep |

| Contents | Description |
|-----------------|------------------------------------|
| J5012 | Socket, 3/8" DR 3/8" 12 PT Deep |
| J5014 | Socket, 3/8" DR 7/16" 12 PT Deep |
| J5016 | Socket, 3/8" DR 1/2" 12 PT Deep |
| J5018 | Socket, 3/8" DR 9/16" 12 PT Deep |
| J5020 | Socket, 3/8" DR 5/8" 12 PT Deep |
| J5022 | Socket, 3/8" DR 11/16" 12 PT Deep |
| J5024 | Socket, 3/8" DR 3/4" 12 PT Deep |
| J5026 | Socket, 3/8" DR 13/16" 12 PT Deep |
| J5028 | Socket, 3/8" DR 7/8" 12 PT Deep |
| J5030 | Socket, 3/8" DR 15/16" 12 PT Deep |
| J5032 | Socket, 3/8" DR 1" 12 PT Deep |
| J5412S | Socket, 1/2" DR 3/8" 8 PT |
| J5414S | Socket, 1/2" DR 7/16" 8 PT |
| J5416S | Socket, 1/2" DR 1/2" 8 PT |
| J5418S | Socket, 1/2" DR 9/16" 8 PT |
| J5420S | Socket, 1/2" DR 5/8" 8 PT |
| J5422S | Socket, 1/2" DR 11/16" 8 PT |
| J5424S | Socket, 1/2" DR 3/4" 8 PT |
| J5426S | Socket, 1/2" DR 13/16" 8 PT |
| J5428S | Socket, 1/2" DR 7/8" 8 PT |
| J5432S | Socket, 1/2" DR 1" 8 PT |
| J5412 | Socket, 1/2" DR 3/8" 12 PT |
| J5414 | Socket, 1/2" DR 7/16" 12 PT |
| J5416 | Socket, 1/2" DR 1/2" 12 PT |
| J5418 | Socket, 1/2" DR 9/16" 12 PT |
| J5420 | Socket, 1/2" DR 5/8" 12 PT |
| J5419 | Socket, 1/2" DR 19/32" 12 PT |
| J5422 | Socket, 1/2" DR 11/16" 12 PT |
| J5424 | Socket, 1/2" DR 3/4" 12 PT |
| J5425 | Socket, 1/2" DR 25/32" 12 PT |
| J5426 | Socket, 1/2" DR 13/16" 12 PT |
| J5428 | Socket, 1/2" DR 7/8" 12 PT |
| J5429 | Socket, 1/2" DR 29/32" 12 PT |
| J5430 | Socket, 1/2" DR 15/16" 12 PT |
| J5432 | Socket, 1/2" DR 1" 12 PT |
| J5434 | Socket, 1/2" DR 1-1/16" 12 PT |
| J5436 | Socket, 1/2" DR 1-1/8" 12 PT |
| J5438 | Socket, 1/2" DR 1-3/16" 12 PT |
| J5440 | Socket, 1/2" DR 1-1/4" 12 PT |
| J5442 | Socket, 1/2" DR 1-5/16" 12 PT |
| J5444 | Socket, 1/2" DR 1-3/8" 12 PT |
| J5448 | Socket, 1/2" DR 1-1/2" 12 PT |
| J5446 | Socket, 1/2" DR 1-7/16" 12 PT |
| J5316 | Socket, 1/2" DR 1/2" 12 PT Deep |
| J5318 | Socket, 1/2" DR 9/16" 12 PT Deep |
| J5320 | Socket, 1/2" DR 5/8" 12 PT Deep |
| J5322 | Socket, 1/2" DR 11/16" 12 PT Deep |
| J5324 | Socket, 1/2" DR 3/4" 12 PT Deep |
| J5326 | Socket, 1/2" DR 13/16" 12 PT Deep |
| J5328 | Socket, 1/2" DR 7/8" 12 PT Deep |
| J5330 | Socket, 1/2" DR 15/16" 12 PT Deep |
| J5332 | Socket, 1/2" DR 1" 12 PT Deep |
| J5334 | Socket, 1/2" DR 1-1/16" 12 PT Deep |
| J5336 | Socket, 1/2" DR 1-1/8" 12 PT Deep |
| J5340 | Socket, 1/2" DR 1-1/4" 12 PT Deep |
| J5444A | Socket, 1/2" DR Drag Link 3/4" |
| J4737 | Socket, Bit 1/4" DR #1 Phillips® |
| J4738 | Socket, Bit 1/4" DR #2 Phillips® |

(CONTINUED ON NEXT PAGE)

334 PC MASTER ADVANCED MAINTENANCE SET (CONTINUED)

Product #: **JCS-0334MAS**



| Contents | Description |
|-----------|---|
| J4743 | Socket, Bit 1/4" DR Slotted 1/4" 1-3/16" |
| J4744 | Socket, Bit 1/4" DR Slotted 3/16" |
| J4745 | Socket, Bit 1/4" DR Slotted 1/4" 1-13/64" |
| J5241 | Socket, Bit 3/8" DR #2 Phillips® |
| J5242 | Socket, Bit 3/8" DR #3 Phillips® |
| J5243 | Socket, Bit 3/8" DR #4 Phillips® |
| J5246 | Socket, Bit 3/8" DR Slotted |
| J47701/16 | Socket, Hex Bit 1/4" DR 1/16" |
| J47705/64 | Socket, Hex Bit 1/4" DR 5/64" |
| J47703/32 | Socket, Hex Bit 1/4" DR 3/32" |
| J47707/64 | Socket, Hex Bit 1/4" DR 7/64" |
| J47701/8 | Socket, Hex Bit 1/4" DR 1/8" |
| J47709/64 | Socket, Hex Bit 1/4" DR 9/64" |
| J47705/32 | Socket, Hex Bit 1/4" DR 5/32" |
| J47703/16 | Socket, Hex Bit 1/4" DR 3/16" |
| J47707/32 | Socket, Hex Bit 1/4" DR 7/32" |
| J47701/4 | Socket, Hex Bit 1/4" DR 1/4" |
| J47705/16 | Socket, Hex Bit 1/4" DR 5/16" |
| J49901/8 | Socket, Hex Bit 3/8" DR 1/8" |
| J49905/32 | Socket, Hex Bit 3/8" DR 5/32" |
| J49903/16 | Socket, Hex Bit 3/8" DR 3/16" |
| J49907/32 | Socket, Hex Bit 3/8" DR 7/32" |
| J49901/4 | Socket, Hex Bit 3/8" DR 1/4" |
| J49905/16 | Socket, Hex Bit 3/8" DR 5/16" |
| J49903/8 | Socket, Hex Bit 3/8" DR 3/8" |
| J54411/2 | Socket, Hex Bit 1/2" DR 1/2" |
| J54419/16 | Socket, Hex Bit 1/2" DR 9/16" |
| J54415/8 | Socket, Hex Bit 1/2" DR 5/8" |
| 33-725 | Tape Rule, FatMax® 1-1/4" x 25' |
| J4771TA | Socket, Universal 1/4" DR 1/4" 12 PT |
| J4772TA | Socket, Universal 1/4" DR 5/16" 12 PT |
| J4773TA | Socket, Universal 1/4" DR 3/8" 12 PT |
| J4774TA | Socket, Universal 1/4" DR 7/16" 12 PT |
| J5475A | Socket, Universal 1/2" DR 1/2" 12 PT |
| J5476A | Socket, Universal 1/2" DR 9/16" 12 PT |
| J5477A | Socket, Universal 1/2" DR 5/8" 12 PT |
| J5273A | Socket, Universal 3/8" DR 3/8" 12 PT |
| J5274A | Socket, Universal 3/8" DR 7/16" 12 PT |
| J5275A | Socket, Universal 3/8" DR 1/2" 12 PT |
| J5276A | Socket, Universal 3/8" DR 9/16" 12 PT |
| J5277A | Socket, Universal 3/8" DR 5/8" 12 PT |
| J5278A | Socket, Universal 3/8" DR 11/16" 12 PT |
| J5279A | Socket, Universal 3/8" DR 3/4" 12 PT |
| J708L | Wrench, Adjustable Clik-Stop® Chrome, 8" |

| Contents | Description |
|----------|---|
| J710L | Wrench, Adjustable Clik-Stop® Chrome, 10" |
| J1210A | Wrench, Combination 5/16" 12 PT |
| J1212ASD | Wrench, Combination 3/8" 12 PT |
| J1214ASD | Wrench, Combination 7/16" 12 PT |
| J1216ASD | Wrench, Combination 1/2" 12 PT |
| J1218ASD | Wrench, Combination 9/16" 12 PT |
| J1220ASD | Wrench, Combination 5/8" 12 PT |
| J1222ASD | Wrench, Combination 11/16" 12 PT |
| J1224ASD | Wrench, Combination 3/4" 12 PT |
| J1226ASD | Wrench, Combination 13/16" 12 PT |
| J1228ASD | Wrench, Combination 7/8" 12 PT |
| J1230ASD | Wrench, Combination 15/16" 12 PT |
| J1232ASD | Wrench, Combination 1" 12 PT |
| J1234ASD | Wrench, Combination 1-1/16" 12 PT |
| J1236ASD | Wrench, Combination 1-1/8" 12 PT |
| J1240ASD | Wrench, Combination 1-1/4" 12 PT |
| J1204EF | Wrench, Combination 1/8" 6 PT Short |
| J1205EF | Wrench, Combination 5/32" 6 PT Short |
| J1206EF | Wrench, Combination 3/16" 6 PT Short |
| J1208EF | Wrench, Combination 1/4" 6 PT Short |
| J1209EF | Wrench, Combination 9/32" 6 PT Short |
| J1210EF | Wrench, Combination 5/16" 6 PT Short |
| J1211EF | Wrench, Combination 11/32" 6 PT Short |
| J1212EF | Wrench, Combination 3/8" 6 PT Short |
| J3751 | Wrench, Flare Nut Combination 3/8" 6 PT |
| J3752 | Wrench, Flare Nut Combination 7/16" 6 PT |
| J3753 | Wrench, Flare Nut Combination 1/2" 6 PT |
| J3754 | Wrench, Flare Nut Combination 9/16" 6 PT |
| J3755 | Wrench, Flare Nut Combination 5/8" 6 PT |
| J3756 | Wrench, Flare Nut Combination 11/16" 6 PT |
| J3757 | Wrench, Flare Nut Combination 3/4" 6 PT |
| J3018 | Wrench, Open End 1/4" x 5/16" |
| J3020 | Wrench, Open End 3/8" x 5/16" |
| J3025 | Wrench, Open End 7/16" x 1/2" |
| J3026 | Wrench, Open End 1/2" x 9/16" |
| J3030 | Wrench, Open End 9/16" x 5/8" |
| J3031 | Wrench, Open End 5/8" x 3/4" |
| J3035 | Wrench, Open End 11/16" x 3/4" |
| J3040 | Wrench, Open End 13/16" x 7/8" |
| J3045 | Wrench, Open End 15/16" x 1" |
| J3050 | Wrench, Open End 1-1/16" x 1-1/8" |
| J810HD | Wrench, Pipe Heavy-Duty 10" |
| J6014C | Wrench, Torque 1/2" DR 50-250 ft-lbs |



334 PC MASTER ADVANCED MAINTENANCE SET WITH ROLLER CABINET J453441-8RD

Product #: JCS-0334MASBX1

- › 334 Pieces.
- › 1/4", 3/8", 1/2" Drive Tools.
- › Designed for fastener sizes 1/16" - 1-1/2", 9 mm - 19 mm.
- › Contains: 197 Sockets and Accessories, 44 Wrenches, 29 Striking and Struck Tools, 17 Pliers, 30 Screwdrivers, 17 Miscellaneous Tools.
- › Enhanced version of Proto® J99671 Advanced Maintenance Set.
- › Weight: 424.0 lbs.

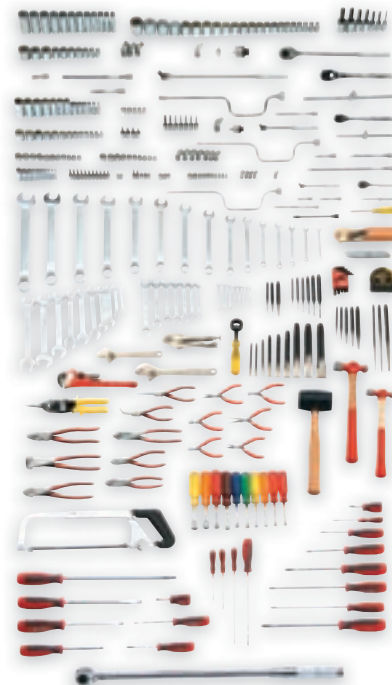

Representative Image; Contents May Differ

334 PC MASTER ADVANCED MAINTENANCE SET WITH ROLLER CABINET J442742-12RD AND TOP CHEST J442719-8RD

Product #: JCS-0334MASBX2

- › 334 Pieces.
- › 1/4", 3/8", 1/2" Drive Tools.
- › Designed for fastener sizes 1/16" - 1-1/2", 9 mm - 19 mm.
- › Contains: 197 Sockets and Accessories, 44 Wrenches, 29 Striking and Struck Tools, 17 Pliers, 30 Screwdrivers, 17 Miscellaneous Tools.
- › Enhanced version of Proto® J99672 Advanced Maintenance Set.
- › Weight: 424.0 lbs.



Representative Image; Contents May Differ



MODULAR SET 1

Product #: JCS-MAS-1



► Weight: 57.0 lbs.



| Contents | Description |
|----------|--|
| J4770A | Adapter, Universal Joint 1/4" DR |
| J5270A | Adapter, Universal Joint 3/8" DR |
| J404 | C-Clamps, Capacity 0"-4", 2 Each |
| J4769 | Driver, 1/4" DR |
| J4759 | Extension, 1/4" DR 2" |
| J4760 | Extension, 1/4" DR 3" |
| J4761 | Extension, 1/4" DR 6" |
| J5260 | Extension, 3/8" DR 3" |
| J5260-06 | Extension, 3/8" DR 6" |
| J5262 | Extension, 3/8" DR 12" |
| J4765 | Extension, Flex 1/4" DR 6-1/4" |
| J5268 | Extension, Flex 3/8" DR 8" |
| J1316PD | Hammer, Ball Pein 16 oz. |
| J4766 | Handle, Hinge 1/4" DR 5-3/4" |
| J5265 | Handle, Hinge 3/8" DR 8-1/2" |
| J4785 | Handle, Sliding T 1/4" DR |
| J5285 | Handle, Sliding T 3/8" DR |
| J5280G | Handle, Speed 3/8 DR |
| J95218 | Knife, Folding Blade |
| J18545B | Knife, Lockback 5" |
| J278G | Pliers, Slip-Joint with Grip 8-1/16" |
| J4056-4 | Puller, Jaw Reversible 4 R |
| J4250N | Puller, Nut Adjustable Reversible |
| J4056PN | Puller, Pin Pivot |
| J4205S | Puller, Screw Forcing Acme |
| J4022T | Puller, Tip Detachable Standard |
| J4255B | Puller, Yoke 3 Way Jaw ACM |
| J5247 | Ratchet Adapter 3/8" DR 2-1/16" |
| J88102 | Screwdriver, Slotted Keystone, Square 1/4" x 2" |
| J88104 | Screwdriver, Slotted Keystone, Square 1/4" x 4" |
| J88106 | Screwdriver, Slotted Keystone, Square 1/4" x 6" |
| J88108 | Screwdriver, Slotted Keystone, Square 1/4" x 8" |
| J88112 | Screwdriver, Slotted Keystone, Square 1/4" x 12" |
| J88002 | Screwdriver, Slotted Keystone, Round 1/4" x 1-1/2" |
| J4708 | Socket, 1/4" DR 1/4" 6 PT |
| J4706 | Socket, 1/4" DR 3/16" 6 PT |
| J4707 | Socket, 1/4" DR 7/32" 6 PT |
| J4709 | Socket, 1/4" DR 9/32" 6 PT |
| J4710 | Socket, 1/4" DR 5/16" 6 PT |
| J4711 | Socket, 1/4" DR 11/32" 6 PT |
| J4714 | Socket, 1/4" DR 7/16" 6 PT |
| J4712 | Socket, 1/4" DR 3/8" 6 PT |
| J4716 | Socket, 1/4" DR 1/2" 6 PT |
| J4718 | Socket, 1/4" DR 9/16" 6 PT |
| J4704M | Socket, 1/4" DR 4 mm 6 PT |
| J4705M | Socket, 1/4" DR 5 mm 6 PT |
| J47055M | Socket, 1/4" DR 5.5 mm 6 PT |
| J4706M | Socket, 1/4" DR 6 mm 6 PT |
| J4707M | Socket, 1/4" DR 7 mm 6 PT |
| J4708M | Socket, 1/4" DR 8 mm 6 PT |
| J4709M | Socket, 1/4" DR 9 mm 6 PT |
| J4710M | Socket, 1/4" DR 10 mm 6 PT |
| J4711M | Socket, 1/4" DR 11 mm 6 PT |
| J4712M | Socket, 1/4" DR 12 mm 6 PT |

| Contents | Description |
|----------|----------------------------------|
| J4713M | Socket, 1/4" DR 13 mm 6 PT |
| J4714M | Socket, 1/4" DR 14 mm 6 PT |
| J4708L | Socket, 1/4" DR 1/4" 6 PT Deep |
| J4706L | Socket, 1/4" DR 3/16" 6 PT Deep |
| J4707L | Socket, 1/4" DR 7/32" 6 PT Deep |
| J4709L | Socket, 1/4" DR 9/32" 6 PT Deep |
| J4710L | Socket, 1/4" DR 5/16" 6 PT Deep |
| J4711L | Socket, 1/4" DR 11/32" 6 PT Deep |
| J4714L | Socket, 1/4" DR 7/16" 6 PT Deep |
| J4712L | Socket, 1/4" DR 3/8" 6 PT Deep |
| J4716L | Socket, 1/4" DR 1/2" 6 PT Deep |
| J4718L | Socket, 1/4" DR 9/16" 6 PT Deep |
| J4704LM | Socket, 1/4" DR 4 mm 6 PT Deep |
| J4705LM | Socket, 1/4" DR 5 mm 6 PT Deep |
| J47055LM | Socket, 1/4" DR 5.5 mm 6 PT Deep |
| J4706LM | Socket, 1/4" DR 6 mm 6 PT Deep |
| J4707LM | Socket, 1/4" DR 7 mm 6 PT Deep |
| J4708LM | Socket, 1/4" DR 8 mm 6 PT Deep |
| J4709LM | Socket, 1/4" DR 9 mm 6 PT Deep |
| J4710LM | Socket, 1/4" DR 10 mm 6 PT Deep |
| J4711LM | Socket, 1/4" DR 11 mm 6 PT Deep |
| J4712LM | Socket, 1/4" DR 12 mm 6 PT Deep |
| J4713LM | Socket, 1/4" DR 13 mm 6 PT Deep |
| J4714LM | Socket, 1/4" DR 14 mm 6 PT Deep |
| J4708S | Socket, 1/4" DR 1/4" 8 PT |
| J4712S | Socket, 1/4" DR 3/8" 8 PT |
| J4710S | Socket, 1/4" DR 5/16" 8 PT |
| J5208S | Socket, 3/8" DR 1/4" 8 PT |
| J5210S | Socket, 3/8" DR 5/16" 8 PT |
| J5212S | Socket, 3/8" DR 3/8" 8 PT |
| J5214S | Socket, 3/8" DR 7/16" 8 PT |
| J5216S | Socket, 3/8" DR 1/2" 8 PT |
| J5208 | Socket, 3/8" DR 1/4" 12 PT |
| J5210 | Socket, 3/8" DR 5/16" 12 PT |
| J5212 | Socket, 3/8" DR 3/8" 12 PT |
| J5214 | Socket, 3/8" DR 7/16" 12 PT |
| J5216 | Socket, 3/8" DR 1/2" 12 PT |
| J5218 | Socket, 3/8" DR 9/16" 12 PT |
| J5220 | Socket, 3/8" DR 5/8" 12 PT |
| J5222 | Socket, 3/8" DR 11/16" 12 PT |
| J5224 | Socket, 3/8" DR 3/4" 12 PT |
| J5226 | Socket, 3/8" DR 13/16" 12 PT |
| J5228 | Socket, 3/8" DR 7/8" 12 PT |
| J5230 | Socket, 3/8" DR 15/16" 12 PT |
| J5232 | Socket, 3/8" DR 1" 12 PT |
| J5208M | Socket, 3/8" DR 8 mm 12 PT |
| J5209M | Socket, 3/8" DR 9 mm 12 PT |
| J5210M | Socket, 3/8" DR 10 mm 12 PT |
| J5211M | Socket, 3/8" DR 11 mm 12 PT |
| J5212M | Socket, 3/8" DR 12 mm 12 PT |
| J5213M | Socket, 3/8" DR 13 mm 12 PT |
| J5214M | Socket, 3/8" DR 14 mm 12 PT |
| J5215M | Socket, 3/8" DR 15 mm 12 PT |
| J5216M | Socket, 3/8" DR 16 mm 12 PT |





| Contents | Description |
|-----------|---|
| J5217M | Socket, 3/8" DR 17 mm 12 PT |
| J5218M | Socket, 3/8" DR 18 mm 12 PT |
| J5219M | Socket, 3/8" DR 19 mm 12 PT |
| J5008 | Socket, 3/8" DR 1/4" 12 PT Deep |
| J5010 | Socket, 3/8" DR 5/16" 12 PT Deep |
| J5012 | Socket, 3/8" DR 3/8" 12 PT Deep |
| J5014 | Socket, 3/8" DR 7/16" 12 PT Deep |
| J5016 | Socket, 3/8" DR 1/2" 12 PT Deep |
| J5018 | Socket, 3/8" DR 9/16" 12 PT Deep |
| J5020 | Socket, 3/8" DR 5/8" 12 PT Deep |
| J5022 | Socket, 3/8" DR 11/16" 12 PT Deep |
| J5024 | Socket, 3/8" DR 3/4" 12 PT Deep |
| J5026 | Socket, 3/8" DR 13/16" 12 PT Deep |
| J5028 | Socket, 3/8" DR 7/8" 12 PT Deep |
| J5030 | Socket, 3/8" DR 15/16" 12 PT Deep |
| J5032 | Socket, 3/8" DR 1" 12 PT Deep |
| J5008M | Socket, 3/8" DR 8 mm 12 PT Deep |
| J5009M | Socket, 3/8" DR 9 mm 12 PT Deep |
| J5010M | Socket, 3/8" DR 10 mm 12 PT Deep |
| J5011M | Socket, 3/8" DR 11 mm 12 PT Deep |
| J5012M | Socket, 3/8" DR 12 mm 12 PT Deep |
| J5013M | Socket, 3/8" DR 13 mm 12 PT Deep |
| J5014M | Socket, 3/8" DR 14 mm 12 PT Deep |
| J5015M | Socket, 3/8" DR 15 mm 12 PT Deep |
| J5016M | Socket, 3/8" DR 16 mm 12 PT Deep |
| J5017M | Socket, 3/8" DR 17 mm 12 PT Deep |
| J5018M | Socket, 3/8" DR 18 mm 12 PT Deep |
| J5019M | Socket, 3/8" DR 19 mm 12 PT Deep |
| J4744 | Socket, Bit 1/4" DR Slotted 3/16" |
| J4737 | Socket, Bit 1/4" DR #1 Phillips® |
| J4738 | Socket, Bit 1/4" DR #2 Phillips® |
| J4743 | Socket, Bit 1/4" DR Slotted 1/4" 1-3/16" |
| J4745 | Socket, Bit 1/4" DR Slotted 1/4" 1-13/64" |
| J5241 | Socket, Bit 3/8" DR #2 Phillips® |
| J5242 | Socket, Bit 3/8" DR #3 Phillips® |
| J5243 | Socket, Bit 3/8" DR #4 Phillips® |
| J5246 | Socket, Bit 3/8" DR Slotted |
| J49901/8 | Socket, Hex Bit 3/8" DR 1/8" |
| J49905/32 | Socket, Hex Bit 3/8" DR 5/32" |
| J49903/16 | Socket, Hex Bit 3/8" DR 3/16" |
| J49907/32 | Socket, Hex Bit 3/8" DR 7/32" |
| J49901/4 | Socket, Hex Bit 3/8" DR 1/4" |
| J49905/16 | Socket, Hex Bit 3/8" DR 5/16" |
| J49903/8 | Socket, Hex Bit 3/8" DR 3/8" |
| J5274A | Socket, Universal 3/8" DR 7/16" 12 PT |
| J5273A | Socket, Universal 3/8" DR 3/8" 12 PT |

| Contents | Description |
|-----------|--|
| J5275A | Socket, Universal 3/8" DR 1/2" 12 PT |
| J5276A | Socket, Universal 3/8" DR 9/16" 12 PT |
| J5277A | Socket, Universal 3/8" DR 5/8" 12 PT |
| J5278A | Socket, Universal 3/8" DR 11/16" 12 PT |
| J5279A | Socket, Universal 3/8" DR 3/4" 12 PT |
| J708 | Wrench, Adjustable 8" |
| J710 | Wrench, Adjustable 10" |
| J712 | Wrench, Adjustable 12" |
| J1122 | Wrench, Box 3/8" x 7/16" 12 PT Short |
| J1120 | Wrench, Box 5/16" x 3/8" 12 PT Short |
| J1126 | Wrench, Box 1/2" x 9/16" 12 PT Short |
| J1131 | Wrench, Box 5/8" x 3/4" 12 PT Short |
| J1210A | Wrench, Combination 5/16" 12 PT |
| J1212ASD | Wrench, Combination 3/8" 12 PT |
| J1214ASD | Wrench, Combination 7/16" 12 PT |
| J1216ASD | Wrench, Combination 1/2" 12 PT |
| J1218ASD | Wrench, Combination 9/16" 12 PT |
| J1220ASD | Wrench, Combination 5/8" 12 PT |
| J1222ASD | Wrench, Combination 11/16" 12 PT |
| J1224ASD | Wrench, Combination 3/4" 12 PT |
| J1226ASD | Wrench, Combination 13/16" 12 PT |
| J1228ASD | Wrench, Combination 7/8" 12 PT |
| J1230ASD | Wrench, Combination 15/16" 12 PT |
| J1232ASD | Wrench, Combination 1" 12 PT |
| J1234ASD | Wrench, Combination 1-1/16" 12 PT |
| J1236ASD | Wrench, Combination 1-1/8" 12 PT |
| J1240ASD | Wrench, Combination 1-1/4" 12 PT |
| J1207MA | Wrench, Combination 7 mm 12 PT |
| J1208MA | Wrench, Combination 8 mm 12 PT |
| J1209MA | Wrench, Combination 9 mm 12 PT |
| J1210MASD | Wrench, Combination 10 mm 12 PT |
| J1211MASD | Wrench, Combination 11 mm 12 PT |
| J1212MASD | Wrench, Combination 12 mm 12 PT |
| J1213MASD | Wrench, Combination 13 mm 12 PT |
| J1214MASD | Wrench, Combination 14 mm 12 PT |
| J1215MASD | Wrench, Combination 15 mm 12 PT |
| J1216MASD | Wrench, Combination 16 mm 12 PT |
| J1217MASD | Wrench, Combination 17 mm 12 PT |
| J1218MASD | Wrench, Combination 18 mm 12 PT |
| J1219MASD | Wrench, Combination 19 mm 12 PT |
| J1220MASD | Wrench, Combination 20 mm 12 PT |
| J1221MASD | Wrench, Combination 21 mm 12 PT |
| J1222MASD | Wrench, Combination 22 mm 12 PT |
| J1223MASD | Wrench, Combination 23 mm 12 PT |
| J1224MASD | Wrench, Combination 24 mm 12 PT |
| J810HD | Wrench, Pipe Heavy-Duty 10" |

MODULAR SET 2

Product #: JCS-MAS-2



► Weight: 27.0 lbs.

| Contents | Description |
|------------|--|
| J1308PD | Hammer, Ball Pein 8 oz. |
| J1368 | Mallet, Rubber |
| J9206 | Nut Driver, 3/16" |
| J9207 | Nut Driver, 7/32" |
| J9208 | Nut Driver, 1/4" |
| J9212 | Nut Driver, 3/8" |
| J9209 | Nut Driver, 9/32" |
| J9210 | Nut Driver, 5/16" |
| J9211 | Nut Driver, 11/32" |
| J9214 | Nut Driver 7/16" |
| J9216 | Nut Driver, 1/2" |
| J9218 | Nut Driver, 9/16" |
| J9220 | Nut Driver, 5/8" |
| J206G | Pliers, Diagonal Cutting with Grip 6-1/16" |
| J291NC | Pliers, Locking Straight 7" |
| J222G | Pliers, Needle-Nose Long Thin 6-1/16" |
| J276G | Pliers, Slip-Joint with Grip 6-9/16" |
| J5257F | Ratchet, 3/8" DR Flex-Head 2-1/16" |
| J88203 | Screwdriver, Slotted Cabinet, Round 1/8" x 3" |
| J88204 | Screwdriver, Slotted Cabinet, Round 1/8" x 4" |
| J88208 | Screwdriver, Slotted Cabinet, Round 1/8" x 8" |
| J88214 | Screwdriver, Slotted Cabinet, Round 3/16" x 4" |
| J88218 | Screwdriver, Slotted Cabinet, Round 3/16" x 8" |
| J47701/16 | Socket, Hex Bit 1/4" DR 1/16" |
| J47705/64 | Socket, Hex Bit 1/4" DR 5/64" |
| J47703/32 | Socket, Hex Bit 1/4" DR 3/32" |
| J47707/64 | Socket, Hex Bit 1/4" DR 7/64" |
| J47705/32 | Socket, Hex Bit 1/4" DR 5/32" |
| J47709/64 | Socket, Hex Bit 1/4" DR 9/64" |
| J47707/32 | Socket, Hex Bit 1/4" DR 7/32" |
| J47701/8 | Socket, Hex Bit 1/4" DR 1/8" |
| J47703/16 | Socket, Hex Bit 1/4" DR 3/16" |
| J47701/4 | Socket, Hex Bit 1/4" DR 1/4" |
| J47705/16 | Socket, Hex Bit 1/4" DR 5/16" |
| J4770-2M | Socket, Hex Bit 1/4" DR 2 mm |
| J4770-2.5M | Socket, Hex Bit 1/4" DR 2.5 mm |
| J4770-3M | Socket, Hex Bit 1/4" DR 3 mm |
| J4770-4M | Socket, Hex Bit 1/4" DR 4 mm |

| Contents | Description |
|-----------|---------------------------------------|
| J4770-5M | Socket, Hex Bit 1/4" DR 5 mm |
| J4770-6M | Socket, Hex Bit 1/4" DR 6 mm |
| J4990-4M | Socket, Hex Bit 3/8" DR 4 mm |
| J4990-5M | Socket, Hex Bit 3/8" DR 5 mm |
| J4990-6M | Socket, Hex Bit 3/8" DR 6 mm |
| J4990-7M | Socket, Hex Bit 3/8" DR 7 mm |
| J4990-8M | Socket, Hex Bit 3/8" DR 8 mm |
| J4990-9M | Socket, Hex Bit 3/8" DR 9 mm |
| J4990-10M | Socket, Hex Bit 3/8" DR 10 mm |
| J5441-12M | Socket, Hex Bit 1/2" DR 12 mm |
| J5441-14M | Socket, Hex Bit 1/2" DR 14 mm |
| J5441-17M | Socket, Hex Bit 1/2" DR 17 mm |
| J4771TA | Socket, Universal 1/4" DR 1/4" 12 PT |
| J4772TA | Socket, Universal 1/4" DR 5/16" 12 PT |
| J4773TA | Socket, Universal 1/4" DR 3/8" 12 PT |
| J4774TA | Socket, Universal 1/4" DR 7/16" 12 PT |
| J706 | Wrench, Adjustable 6" |
| J3018 | Wrench, Open End 1/4" x 5/16" |
| J3020 | Wrench, Open End 3/8" x 5/16" |
| J3025 | Wrench, Open End 7/16" x 1/2" |
| J3026 | Wrench, Open End 1/2" x 9/16" |
| J3030 | Wrench, Open End 9/16" x 5/8" |
| J3035 | Wrench, Open End 11/16" x 3/4" |
| J3031 | Wrench, Open End 5/8" x 3/4" |
| J3040 | Wrench, Open End 13/16" x 7/8" |
| J3045 | Wrench, Open End 15/16" x 1" |
| J3050 | Wrench, Open End 1-1/16" x 1-1/8" |
| J30607 | Wrench, Open End 6 mm x 7 mm |
| J30809 | Wrench, Open End 8 mm x 9 mm |
| J31011 | Wrench, Open End 10 mm x 11 mm |
| J31213 | Wrench, Open End 12 mm x 13 mm |
| J31415 | Wrench, Open End 14 mm x 15 mm |
| J31617 | Wrench, Open End 16 mm x 17 mm |
| J31819 | Wrench, Open End 18 mm x 19 mm |
| J32022 | Wrench, Open End 20 mm x 22 mm |
| J32123 | Wrench, Open End 21 mm x 23 mm |
| J32426 | Wrench, Open End 24 mm x 26 mm |
| J814HD | Wrench, Pipe Heavy-Duty 14" |



MODULAR SET 3

Product #: **JCS-MAS-3**



› Weight: 121.0 lbs.

| Contents | Description |
|--------------|--|
| J5470A | Adapter, Universal Joint 1/2" DR |
| J86A3/16 | Chisel, Cold 1/4" |
| J86A1/4 | Chisel, Cold 5/16" |
| J86A5/16 | Chisel, Cold 3/8" |
| J86A7/16 | Chisel, Cold 1/2" |
| J86A1/2 | Chisel, Cold 5/8" |
| J86A5/8 | Chisel, Cold 3/4" |
| J86A3/4X8 | Chisel, Cold 7/8" |
| J86A7/8X8 | Chisel, Cold 1" |
| J86A1X8 | Chisel, Cold 1-3/16" |
| J9523 | Extractor, Screw 1/8" |
| J9521 | Extractor, Screw 3/16" |
| J9522 | Extractor, Screw 15/64" |
| J9524 | Extractor, Screw 5/16" |
| J9525 | Extractor, Screw 3/8" |
| J9526 | Extractor, Screw 15/32" |
| J9527 | Extractor, Screw 9/16" |
| J9528 | Extractor, Screw 21/32" |
| J9525B | Extractor, Screw 13/16" |
| J9529 | Extractor, Screw 1-1/16" |
| J5460 | Extension, 1/2" DR 2-1/2" |
| J5461 | Extension, 1/2" DR 5" |
| J5463 | Extension, 1/2" DR 10" |
| J5260W | Extension, Wobble 3/8" DR 3" |
| J5260-06W | Extension, Wobble 3/8" DR 6" |
| J1430-HB | Hammer Head |
| 57-532 | Hammer, Compo-Cast® 21 oz. |
| J5468 | Handle, Hinge 1/2" DR |
| J5485 | Handle, Sliding T 1/2" DR |
| J5480G | Handle, Speed 1/2 DR |
| J4984 | Hex Key, 9 PC Metric Set |
| J4980 | Hex Key, 13 PC Standard Set |
| J2108 | Holder, Punch and Chisel |
| J2373 | Mirror, Rectangular Telescoping 2-1/8" |
| J209G | Pliers, Diagonal Cutting with Grip 7-5/16" |
| J227G | Pliers, Duckbill with Grip 7-25/32" |
| J272G | Pliers, End Cutting High Leverage 8-1/4" |
| J268G | Pliers, Lineman's with Grip 8-5/8" |
| J292NC | Pliers, Locking Curved 10" |
| J225G | Pliers, Needle-Nose Bent Nose 6-5/16" |
| J226G | Pliers, Needle-Nose with Cutter 6-5/8" |
| J298 | Pliers, Wire Strippers 8-1/4" |
| J413/8 | Punch, Center 3/8" |
| J411/2 | Punch, Center 1/2" |
| J965/16 | Punch, Drift 1/8" |
| J963/8 | Punch, Drift 3/16" |
| J961/2 | Punch, Drift 1/4" |
| J475/16X1/8 | Punch, Pin 1/8" |
| J471/4X3/32 | Punch, Pin 3/32" |
| J471/2X1/4 | Punch, Pin 1/4" |
| J475/16X5/32 | Punch, Pin 5/32" |
| J473/8X3/16 | Punch, Pin 3/16" |
| J477/16X7/32 | Punch, Pin 7/32" |
| J445/16 | Punch, Prick 5/16" |

| Contents | Description |
|----------|-------------------------------------|
| J501/2 | Punch, Starting 1/4" |
| J501/4 | Punch, Starting 3/32" |
| J505/16 | Punch, Starting 1/8" |
| J503/8 | Punch, Starting 3/16" |
| J507/16 | Punch, Starting 7/32" |
| J5447 | Ratchet Adapter 1/2" DR 2-21/32" |
| J5457F | Ratchet, 1/2" DR Flex-Head 17-3/32" |
| J2375 | Retrieval Tool, Pocket Magnetic |
| J88393 | Screwdriver, Phillips® #0 |
| J88313 | Screwdriver, Phillips® #1 |
| J88318 | Screwdriver, Phillips® #1 |
| J88322 | Screwdriver, Phillips® #2 |
| J88324 | Screwdriver, Phillips® #2 |
| J88328 | Screwdriver, Phillips® #2 |
| J88336 | Screwdriver, Phillips® #3 |
| J88348 | Screwdriver, Phillips® #4 |
| J5412S | Socket, 1/2" DR 3/8" 8 PT |
| J5414S | Socket, 1/2" DR 7/16" 8 PT |
| J5416S | Socket, 1/2" DR 1/2" 8 PT |
| J5418S | Socket, 1/2" DR 9/16" 8 PT |
| J5420S | Socket, 1/2" DR 5/8" 8 PT |
| J5422S | Socket, 1/2" DR 11/16" 8 PT |
| J5424S | Socket, 1/2" DR 3/4" 8 PT |
| J5426S | Socket, 1/2" DR 13/16" 8 PT |
| J5428S | Socket, 1/2" DR 7/8" 8 PT |
| J5432S | Socket, 1/2" DR 1" 8 PT |
| J5412 | Socket, 1/2" DR 3/8" 12 PT |
| J5414 | Socket, 1/2" DR 7/16" 12 PT |
| J5416 | Socket, 1/2" DR 1/2" 12 PT |
| J5418 | Socket, 1/2" DR 9/16" 12 PT |
| J5419 | Socket, 1/2" DR 19/32" 12 PT |
| J5420 | Socket, 1/2" DR 5/8" 12 PT |
| J5422 | Socket, 1/2" DR 11/16" 12 PT |
| J5424 | Socket, 1/2" DR 3/4" 12 PT |
| J5425 | Socket, 1/2" DR 25/32" 12 PT |
| J5426 | Socket, 1/2" DR 13/16" 12 PT |
| J5428 | Socket, 1/2" DR 7/8" 12 PT |
| J5429 | Socket, 1/2" DR 29/32" 12 PT |
| J5430 | Socket, 1/2" DR 15/16" 12 PT |
| J5432 | Socket, 1/2" DR 1" 12 PT |
| J5434 | Socket, 1/2" DR 1-1/16" 12 PT |
| J5436 | Socket, 1/2" DR 1-1/8" 12 PT |
| J5440 | Socket, 1/2" DR 1-1/4" 12 PT |
| J5448 | Socket, 1/2" DR 1-1/2" 12 PT |
| J5438 | Socket, 1/2" DR 1-3/16" 12 PT |
| J5444 | Socket, 1/2" DR 1-3/8" 12 PT |
| J5442 | Socket, 1/2" DR 1-5/16" 12 PT |
| J5446 | Socket, 1/2" DR 1-7/16" 12 PT |
| J5410M | Socket, 1/2" DR 10 mm 12 PT |
| J5411M | Socket, 1/2" DR 11 mm 12 PT |
| J5412M | Socket, 1/2" DR 12 mm 12 PT |
| J5413M | Socket, 1/2" DR 13 mm 12 PT |
| J5414M | Socket, 1/2" DR 14 mm 12 PT |
| J5415M | Socket, 1/2" DR 15 mm 12 PT |

(CONTINUED ON NEXT PAGE)



MODULAR SET 3 (CONTINUED)

Product #: **JCS-MAS-3**



| Contents | Description |
|-----------|---|
| J5416M | Socket, 1/2" DR 16 mm 12 PT |
| J5417M | Socket, 1/2" DR 17 mm 12 PT |
| J5418M | Socket, 1/2" DR 18 mm 12 PT |
| J5419M | Socket, 1/2" DR 19 mm 12 PT |
| J5420M | Socket, 1/2" DR 20 mm 12 PT |
| J5421M | Socket, 1/2" DR 21 mm 12 PT |
| J5422M | Socket, 1/2" DR 22 mm 12 PT |
| J5423M | Socket, 1/2" DR 23 mm 12 PT |
| J5424M | Socket, 1/2" DR 24 mm 12 PT |
| J5316 | Socket, 1/2" DR 1/2" 12 PT Deep |
| J5318 | Socket, 1/2" DR 9/16" 12 PT Deep |
| J5320 | Socket, 1/2" DR 5/8" 12 PT Deep |
| J5322 | Socket, 1/2" DR 11/16" 12 PT Deep |
| J5324 | Socket, 1/2" DR 3/4" 12 PT Deep |
| J5326 | Socket, 1/2" DR 13/16" 12 PT Deep |
| J5328 | Socket, 1/2" DR 7/8" 12 PT Deep |
| J5330 | Socket, 1/2" DR 15/16" 12 PT Deep |
| J5332 | Socket, 1/2" DR 1" 12 PT Deep |
| J5334 | Socket, 1/2" DR 1-1/16" 12 PT Deep |
| J5340 | Socket, 1/2" DR 1-1/4" 12 PT Deep |
| J5475A | Socket, Universal 1/2" DR 1/2" 12 PT |
| J5476A | Socket, Universal 1/2" DR 9/16" 12 PT |
| J5477A | Socket, Universal 1/2" DR 5/8" 12 PT |
| J54411/4 | Socket, Hex Bit 1/2" DR 1/4" |
| J54415/16 | Socket, Hex Bit 1/2" DR 5/16" |
| J54413/8 | Socket, Hex Bit 1/2" DR 3/8" |
| J54417/16 | Socket, Hex Bit 1/2" DR 7/16" |
| J54411/2 | Socket, Hex Bit 1/2" DR 1/2" |
| J54419/16 | Socket, Hex Bit 1/2" DR 9/16" |
| J54415/8 | Socket, Hex Bit 1/2" DR 5/8" |
| J5444A | Socket, 1/2" DR Drag Link 3/4" |
| 10-099 | Stanley® Clasic 99® Retractable Blade Utility Knife |
| 33-212 | Tape Rule, Stanley® Powerlock® with Metal Case 1/2" x 12' |
| J1170 | Wrench, Box 5/16" x 3/8" 12 PT |
| J1171 | Wrench, Box 7/16" x 1/2" 12 PT |
| J1172 | Wrench, Box 9/16" x 5/8" 12 PT |
| J1173 | Wrench, Box 11/16" x 3/4" 12 PT |
| J1174 | Wrench, Box 13/16" x 7/8" 12 PT |
| J1175 | Wrench, Box 15/16" x 1" 12 PT |
| J1176 | Wrench, Box 1-1/16" x 1-1/8" 12 PT |
| J1050M | Wrench, Box 6 x 7 mm 12 PT |
| J1051M | Wrench, Box 8 x 9 mm 12 PT |
| J1053M | Wrench, Box 10 x 11 mm 12 PT |
| J1057M | Wrench, Box 12 x 13 mm 12 PT |
| J1061M | Wrench, Box 14 x 15 mm 12 PT |
| J1064M | Wrench, Box 16 x 18 mm 12 PT |
| J1065M | Wrench, Box 17 x 19 mm 12 PT |

| Contents | Description |
|-----------|--|
| J1072M | Wrench, Box 21 x 24 mm 12 PT |
| J1073M | Wrench, Box 22 x 24 mm 12 PT |
| J1077M | Wrench, Box 27 x 30 mm 12 PT |
| J1079M | Wrench, Box 30 x 32 mm 12 PT |
| J1242 | Wrench, Combination 1-5/16" 12 PT |
| J1244 | Wrench, Combination 1-3/8" 12 PT |
| J1246 | Wrench, Combination 1-7/16" 12 PT |
| J1248 | Wrench, Combination 1-1/2" 12 PT |
| J4909MCF | Wrench, Crowfoot 3/8" DR 9 mm Open End |
| J4910MCF | Wrench, Crowfoot 3/8" DR 10 mm Open End |
| J4911MCF | Wrench, Crowfoot 3/8" DR 11 mm Open End |
| J4912MCF | Wrench, Crowfoot 3/8" DR 12 mm Open End |
| J4913MCF | Wrench, Crowfoot 3/8" DR 13 mm Open End |
| J4914MCF | Wrench, Crowfoot 3/8" DR 14 mm Open End |
| J4915MCF | Wrench, Crowfoot 3/8" DR 15 mm Open End |
| J4916MCF | Wrench, Crowfoot 3/8" DR 16 mm Open End |
| J4917MCF | Wrench, Crowfoot 3/8" DR 17 mm Open End |
| J4918MCF | Wrench, Crowfoot 3/8" DR 18 mm Open End |
| J4919MCF | Wrench, Crowfoot 3/8" DR 19 mm Open End |
| J4920MCF | Wrench, Crowfoot 3/8" DR 20 mm Open End |
| J4921MCF | Wrench, Crowfoot 3/8" DR 21 mm Open End |
| J4922MCF | Wrench, Crowfoot 3/8" DR 22 mm Open End |
| J4923MCF | Wrench, Crowfoot 3/8" DR 23 mm Open End |
| J4924MCF | Wrench, Crowfoot 3/8" DR 24 mm Open End |
| J3707M | Wrench, Flare Nut 7 mm x 8 mm |
| J3709M | Wrench, Flare Nut 9 mm x 11 mm |
| J3710M | Wrench, Flare Nut 10 mm x 12 mm |
| J3713M | Wrench, Flare Nut 13 mm x 14 mm |
| J3715M | Wrench, Flare Nut 15 mm x 17 mm |
| J3751 | Wrench, Flare Nut Combination 3/8" 6 PT |
| J3752 | Wrench, Flare Nut Combination 7/16" 6 PT |
| J3753 | Wrench, Flare Nut Combination 1/2" 6 PT |
| J3754 | Wrench, Flare Nut Combination 9/16" 6 PT |
| J3755 | Wrench, Flare Nut Combination 5/8" 6 PT |
| J3756 | Wrench, Flare Nut Combination 11/16" 6 PT |
| J3757 | Wrench, Flare Nut Combination 3/4" 6 PT |
| J818HD | Wrench, Pipe Heavy-Duty 18" |
| J1191T-A | Wrench, Ratcheting Box 1/4" x 5/16" 12 PT |
| J1192T-A | Wrench, Ratcheting Box 3/8" x 7/16" 12 PT |
| J1193T-A | Wrench, Ratcheting Box 1/2" x 9/16" 12 PT |
| J1194-A | Wrench, Ratcheting Box 5/8" x 11/16" 12 PT |
| J1195-A | Wrench, Ratcheting Box 3/4" x 7/8" 12 PT |
| J1191M-A | Wrench, Ratcheting Box 7 mm x 8 mm |
| J1192M-A | Wrench, Ratcheting Box 9 mm x 10 mm |
| J1193MA-A | Wrench, Ratcheting Box 11 mm x 12 mm |
| J1194MA-A | Wrench, Ratcheting Box 13 mm x 14 mm |
| J1195M-A | Wrench, Ratcheting Box 15 mm x 17 mm |
| J6014C | Wrench, Torque 1/2" DR 50-250 ft-lbs |



MODULAR SET 4

Product #: JCS-MAS-4

Weight: 93.27 lbs.



| Contents | Description |
|----------|--|
| J5670 | Adapter, Universal Joint 3/4" DR |
| J2126 | Bar, 12" Long 1/2" Tip |
| J2130 | Bar, 16" Long 5/8" Tip |
| J2120 | Bar, Pry Aligning 18" |
| J2124 | Bar, Pry Aligning 24" |
| J5660 | Extension, 3/4" DR 4" |
| J5661 | Extension, 3/4" DR 8" |
| J5663 | Extension, 3/4" DR 16" |
| J1332PD | Hammer, Ball Pein 32 oz. |
| 57-534 | Hammer, Compo-Cast® 52 oz. |
| J5668 | Handle, Hinge 3/4" DR 20" |
| J5685 | Handle, Sliding T 3/4" DR |
| J4780G | Handle, Speed 1/4" DR |
| J286LNXL | Pliers, Locking Mini Long Nose 6-29/32" |
| J360A | Pliers, 6 PC Retaining Ring Set |
| J261SG | Pliers, Tongue and Groove 5" with Grip |
| J262SG | Pliers, Tongue and Groove 6-1/2" with Grip |
| J260SG | Pliers, Tongue and Groove 10-3/16" with Grip |
| J265SG | Pliers, Tongue and Groove 16" with Grip |
| J2306 | Puller, Cotter Pin Tool |
| J5649 | Ratchet, 3/4" DR |
| 28-240 | Scraper, Flexible Nylon 1-1/4" |
| J2336 | Scrapers, Gasket and Carbon |
| J9884 | Screw Starter, Phillips® Tip |
| J9853 | Screw Starter, Standard Tip |
| J322 | Snips, Straight 12-3/4" |
| J303S | Snips, Aviation Straight |
| J308 | Snips, Miniature |
| J5336 | Socket, 1/2" DR 1-1/8" 12 PT Deep |
| J5310M | Socket, 1/2" DR 10 mm 12 PT Deep |
| J5311M | Socket, 1/2" DR 11 mm 12 PT Deep |
| J5312M | Socket, 1/2" DR 12 mm 12 PT Deep |
| J5313M | Socket, 1/2" DR 13 mm 12 PT Deep |
| J5314M | Socket, 1/2" DR 14 mm 12 PT Deep |
| J5315M | Socket, 1/2" DR 15 mm 12 PT Deep |
| J5316M | Socket, 1/2" DR 16 mm 12 PT Deep |
| J5317M | Socket, 1/2" DR 17 mm 12 PT Deep |
| J5318M | Socket, 1/2" DR 18 mm 12 PT Deep |
| J5319M | Socket, 1/2" DR 19 mm 12 PT Deep |
| J5320M | Socket, 1/2" DR 20 mm 12 PT Deep |
| J5321M | Socket, 1/2" DR 21 mm 12 PT Deep |
| J5322M | Socket, 1/2" DR 22 mm 12 PT Deep |
| J5323M | Socket, 1/2" DR 23 mm 12 PT Deep |
| J5324M | Socket, 1/2" DR 24 mm 12 PT Deep |
| J5446A | Socket, 1/2" DR Drag Link |
| J5528 | Socket, 3/4" DR 7/8" 12 PT |
| J5530 | Socket, 3/4" DR 15/16" 12 PT |
| J5532 | Socket, 3/4" DR 1" 12 PT |
| J5534 | Socket, 3/4" DR 1-1/16" 12 PT |
| J5536 | Socket, 3/4" DR 1-1/8" 12 PT |
| J5538 | Socket, 3/4" DR 1-3/16" 12 PT |
| J5540 | Socket, 3/4" DR 1-1/4" 12 PT |
| J5542 | Socket, 3/4" DR 1-5/16" 12 PT |
| J5544 | Socket, 3/4" DR 1-3/8" 12 PT |
| J5546 | Socket, 3/4" DR 1-7/16" 12 PT |
| J5548 | Socket, 3/4" DR 1-1/2" 12 PT |

| Contents | Description |
|----------|--|
| J5550 | Socket, 3/4" DR 1-9/16" 12 PT |
| J5552 | Socket, 3/4" DR 1-5/8" 12 PT |
| J5554 | Socket, 3/4" DR 1-11/16" 12 PT |
| J5556 | Socket, 3/4" DR 1-3/4" 12 PT |
| J5558 | Socket, 3/4" DR 1-13/16" 12 PT |
| J5560 | Socket, 3/4" DR 1-7/8" 12 PT |
| J5564 | Socket, 3/4" DR 2" 12 PT |
| J5572 | Socket, 3/4" DR 2-1/4" 12 PT |
| J5568 | Socket, 3/4" DR 2-1/8" 12 PT |
| J5570 | Socket, 3/4" DR 2-3/16" 12 PT |
| J5576 | Socket, 3/4" DR 2-3/8" 12 PT |
| J715 | Wrench, Adjustable 15" |
| J3315 | Wrench, Angle 15/64" |
| J3314 | Wrench, Angle 7/32" |
| J3316 | Wrench, Angle 1/4" |
| J3318 | Wrench, Angle 9/32" |
| J3320 | Wrench, Angle 5/16" |
| J3322 | Wrench, Angle 11/32" |
| J3324 | Wrench, Angle 3/8" |
| J3328 | Wrench, Angle 7/16" |
| J3332 | Wrench, Angle 1/2" |
| J801 | Wrench, Chain |
| J1204EF | Wrench, Combination 1/8" 6 PT Short |
| J1205EF | Wrench, Combination 5/32" 6 PT Short |
| J1206EF | Wrench, Combination 3/16" 6 PT Short |
| J1208EF | Wrench, Combination 1/4" 6 PT Short |
| J1209EF | Wrench, Combination 9/32" 6 PT Short |
| J1210EF | Wrench, Combination 5/16" 6 PT Short |
| J1212EF | Wrench, Combination 3/8" 6 PT Short |
| J1211EF | Wrench, Combination 11/32" 6 PT Short |
| J4912CF | Wrench, Crowfoot 3/8" DR 3/8" Open End |
| J4914CF | Wrench, Crowfoot 3/8" DR 7/16" Open End |
| J4916CF | Wrench, Crowfoot 3/8" DR 1/2" Open End |
| J4918CF | Wrench, Crowfoot 3/8" DR 9/16" Open End |
| J4920CF | Wrench, Crowfoot 3/8" DR 5/8" Open End |
| J4922CF | Wrench, Crowfoot 3/8" DR 11/16" Open End |
| J4924CF | Wrench, Crowfoot 3/8" DR 3/4" Open End |
| J4926CF | Wrench, Crowfoot 3/8" DR 13/16" Open End |
| J4928CF | Wrench, Crowfoot 3/8" DR 7/8" Open End |
| J3812 | Wrench, Flare Nut Ratcheting 3/8" |
| J3814 | Wrench, Flare Nut Ratcheting 7/16" |
| J3816 | Wrench, Flare Nut Ratcheting 1/2" |
| J3818 | Wrench, Flare Nut Ratcheting 9/16" |
| J3820 | Wrench, Flare Nut Ratcheting 5/8" |
| J3822 | Wrench, Flare Nut Ratcheting 11/16" |
| J3824 | Wrench, Flare Nut Ratcheting 3/4" |
| J1725 | Wrench, Obstruction 7/16" x 1/2" |
| J1730 | Wrench, Obstruction 9/16" x 5/8" |
| J1731 | Wrench, Obstruction 5/8" x 3/4" |
| J1270-12 | Wrench, Swivel Combination 3/8" 12 PT |
| J1270-14 | Wrench, Swivel Combination 7/16" 12 PT |
| J1270-16 | Wrench, Swivel Combination 1/2" 12 PT |
| J1270-18 | Wrench, Swivel Combination 9/16" 12 PT |
| J1270-20 | Wrench, Swivel Combination 5/8" 12 PT |
| J1270-22 | Wrench, Swivel Combination 11/16" 12 PT |
| J1270-24 | Wrench, Swivel Combination 3/4" 12 PT |



MODULAR SET 5

Product #: JCS-MAS-5



► Weight: 53.12 lbs.

| Contents | Description |
|----------|--|
| J60002 | Bit, Insert #1 Phillips® 1/4" Hex |
| J60050 | Bit, Insert #1 Phillips® 5/16" Hex |
| J60008 | Bit, Insert #2 Phillips® 1/4" Hex |
| J60052 | Bit, Insert #2 Phillips® 5/16" Hex |
| J60020 | Bit, Insert #3 Phillips® 1/4" Hex |
| J60054 | Bit, Insert #3 Phillips® 5/16" Hex |
| J60202 | Bit, Insert 3/16" Slotted 1/4" Hex |
| J60208 | Bit, Insert 9/32" Slotted 1/4" Hex |
| J60256 | Bit, Insert 10F-12R Slot 5/16" Hex |
| J60262 | Bit, Insert 14F-16R Slot 5/16" Hex |
| J6931 | Bit, Holder Power 3/8" DR 1/4" Hex |
| J6930 | Bit, Holder Power 3/8" DR 5/16" Hex |
| J7099 | Impact, Hand Driver 3/8" |
| J9204M | Nut Driver, 4 mm |
| J9205M | Nut Driver, 5 mm |
| J92055M | Nut Driver, 5.5 mm |
| J9206M | Nut Driver, 6 mm |
| J9207M | Nut Driver, 7 mm |
| J9208M | Nut Driver, 8 mm |
| J9209M | Nut Driver, 9 mm |
| J9210M | Nut Driver, 10 mm |
| J9211M | Nut Driver, 11 mm |
| J9213M | Nut Driver, 13 mm |
| J9214M | Nut Driver, 14 mm |
| J4331N | Puller, Nut Hex |
| J4333N | Puller, Nut Hex |
| J4333AR | Puller, Rod Threader 3/4"-1" |
| J4331R | Puller, Screw Cap |
| J4331P | Puller, Separator Plate |
| J4333P | Puller, Separator Plate |
| J4040-1 | Puller, Step Plate 3/4" |
| J4040-2 | Puller, Step Plate 7/8" |
| J4040-3 | Puller, Step Plate 1" |
| J4040-4 | Puller, Step Plate 1-1/8" |
| J4040-5 | Puller, Step Plate 1-1/4" |
| J4040-6 | Puller, Step Plate 1-3/8" |
| J4040-7 | Puller, Step Plate 1-1/2" |
| J4040-8 | Puller, Step Plate 1-5/8" |
| J4040-9 | Puller, Step Plate 1-3/4" |
| J4040-10 | Puller, Step Plate 1-7/8" |
| J4040-11 | Puller, Step Plate 2" |
| 28-540 | Scraper, Flexible 1-1/4" Wood Handle |
| J69X12 | Socket, Extractor 3/8" |
| J4770TA | Socket, Universal 1/4" DR 7/32" 12 PT |
| J4777TA | Socket, Universal 1/4" DR 9/32" 12 PT |
| J4778TA | Socket, Universal 1/4" DR 11/32" 12 PT |
| J4776TA | Socket, Universal 1/4" DR 9/16" 12 PT |
| J4775TA | Socket, Universal 1/4" DR 1/2" 12 PT |
| J5273HA | Socket, Universal 3/8" DR 3/8" 6 PT |
| J5274HA | Socket, Universal 3/8" DR 7/16" 6 PT |
| J5275HA | Socket, Universal 3/8" DR 1/2" 6 PT |
| J5276HA | Socket, Universal 3/8" DR 9/16" 6 PT |
| J5277HA | Socket, Universal 3/8" DR 5/8" 6 PT |
| J5278HA | Socket, Universal 3/8" DR 11/16" 6 PT |

| Contents | Description |
|----------|--------------------------------------|
| J5279HA | Socket, Universal 3/8" DR 3/4" 6 PT |
| J5273HAM | Socket, Universal 3/8" DR 10 mm 6 PT |
| J5274HAM | Socket, Universal 3/8" DR 11 mm 6 PT |
| J5275HAM | Socket, Universal 3/8" DR 12 mm 6 PT |
| J5276HAM | Socket, Universal 3/8" DR 13 mm 6 PT |
| J5277HAM | Socket, Universal 3/8" DR 14 mm 6 PT |
| J5278HAM | Socket, Universal 3/8" DR 15 mm 6 PT |
| J5279HAM | Socket, Universal 3/8" DR 16 mm 6 PT |
| J5280HAM | Socket, Universal 3/8" DR 17 mm 6 PT |
| J5281HAM | Socket, Universal 3/8" DR 18 mm 6 PT |
| J5282HAM | Socket, Universal 3/8" DR 19 mm 6 PT |
| J69X09 | Socket, Extractor 1/4" DR 7 mm |
| J69X10 | Socket, Extractor 1/4" DR 8 mm |
| J69X11 | Socket, Extractor 1/4" DR 9 mm |
| J69X13 | Socket, Extractor 1/4" DR 10 mm |
| J69X14 | Socket, Extractor 1/4" DR 11 mm |
| J69X15 | Socket, Extractor 1/4" DR 12 mm |
| J69X16 | Socket, Extractor 1/4" DR 13 mm |
| J69X18 | Socket, Extractor 1/4" DR 14 mm |
| J69X20 | Socket, Extractor 1/4" DR 15 mm |
| J7208H | Socket, Impact 3/8" DR 1/4" 6 PT |
| J7209H | Socket, Impact 3/8" DR 9/32" 6 PT |
| J7210H | Socket, Impact 3/8" DR 5/16" 6 PT |
| J7211H | Socket, Impact 3/8" DR 11/32" 6 PT |
| J7212H | Socket, Impact 3/8" DR 3/8" 6 PT |
| J7214H | Socket, Impact 3/8" DR 7/16" 6 PT |
| J7216H | Socket, Impact 3/8" DR 1/2" 6 PT |
| J7218H | Socket, Impact 3/8" DR 9/16" 6 PT |
| J7220H | Socket, Impact 3/8" DR 5/8" 6 PT |
| J7222H | Socket, Impact 3/8" DR 11/16" 6 PT |
| J7224H | Socket, Impact 3/8" DR 3/4" 6 PT |
| J7226H | Socket, Impact 3/8" DR 13/16" 6 PT |
| J7228H | Socket, Impact 3/8" DR 7/8" 6 PT |
| J7230H | Socket, Impact 3/8" DR 15/16" 6 PT |
| J7232H | Socket, Impact 3/8" DR 1" 6 PT |
| 68-768 | Tap and Die, 76 PC Set |
| J350 | Tubing Cutter |
| J351 | Tubing Flaring Tool |
| J3112 | Wrench, Angle 3/8" |
| J3114 | Wrench, Angle 7/16" |
| J3116 | Wrench, Angle 1/2" |
| J3118 | Wrench, Angle 9/16" |
| J3120 | Wrench, Angle 5/8" |
| J3122 | Wrench, Angle 11/16" |
| J3124 | Wrench, Angle 3/4" |
| J3126 | Wrench, Angle 13/16" |
| J3128 | Wrench, Angle 7/8" |
| J3130 | Wrench, Angle 15/16" |
| J3132 | Wrench, Angle 1" |
| J3134 | Wrench, Angle 1-1/16" |
| J3136 | Wrench, Angle 1-1/8" |
| J3140 | Wrench, Angle 1-1/4" |
| J3109M | Wrench, Angle 9 mm |
| J3110M | Wrench, Angle 10 mm |





| Contents | Description |
|-----------------|----------------------------------|
| J3111M | Wrench, Angle 11 mm |
| J3112M | Wrench, Angle 12 mm |
| J3113M | Wrench, Angle 13 mm |
| J3114M | Wrench, Angle 14 mm |
| J3115M | Wrench, Angle 15 mm |
| J3116M | Wrench, Angle 16 mm |
| J3117M | Wrench, Angle 17 mm |
| J3118M | Wrench, Angle 18 mm |
| J3119M | Wrench, Angle 19 mm |
| J5336FL | Wrench, Crowfoot 1/2" DR 1-1/8" |
| J5338FL | Wrench, Crowfoot 1/2" DR 1-3/16" |

| Contents | Description |
|-----------------|-----------------------------------|
| J5340FL | Wrench, Crowfoot 1/2" DR 1-1/4" |
| J5342FL | Wrench, Crowfoot 1/2" DR 1-5/16" |
| J5344FL | Wrench, Crowfoot 1/2" DR 1-3/8" |
| J5346FL | Wrench, Crowfoot 1/2" DR 1-7/16" |
| J5348FL | Wrench, Crowfoot 1/2" DR 1-1/2" |
| J5350FL | Wrench, Crowfoot 1/2" DR 1-9/16" |
| J5352FL | Wrench, Crowfoot 1/2" DR 1-5/8" |
| J5354FL | Wrench, Crowfoot 1/2" DR 1-11/16" |
| J5356FL | Wrench, Crowfoot 1/2" DR 1-3/4" |
| J5358FL | Wrench, Crowfoot 1/2" DR 1-13/16" |
| J5360FL | Wrench, Crowfoot 1/2" DR 1-7/8" |

MODULAR SET 6

Product #: JCS-MAS-6



▶ Weight: 53.12 lbs.

| Contents | Description | Contents | Description |
|-----------|-------------------------------------|----------|---|
| J2142 | Bar, Pry Aligning 18" | J4333N | Puller, Nut Hex |
| J2146 | Bar, Pry Aligning 28" | J4056PN | Puller, Pin Pivot |
| J61906 | Bit, 38 PC Insert Set | J4277B | Puller, Rear Axle Flange F |
| J9969-NA | Box, General Purpose with Tray | J4275R | Puller, Rod Slide Acme Threader |
| J404 | C-Clamps, Capacity 0"-4", 2 Each | J4333AR | Puller, Rod Threader 3/4"-1" |
| J4761L | Extension, Locking 1/4" DR 6" | J4205E | Puller, Screw Cap |
| J5260-06L | Extension, Locking 3/8" DR 6" | J4331R | Puller, Screw Cap |
| J5463L | Extension, Locking 1/2" DR 10" | J4205S | Puller, Screw Forcing Acme |
| J7180P | Extension, Impact 1/2" DR 2" | J4225S | Puller, Screw Forcing Acme |
| J7181P | Extension, Impact 1/2" DR 5" | J4331P | Puller, Separator Plate |
| J4760W | Extension, Wobble 1/4" DR 3" | J4333P | Puller, Separator Plate |
| J5261W | Extension, Wobble 3/8" DR 8" | J4260H | Puller, Slide Hammer 2-1/2" |
| J5460W | Extension, Wobble 1/2" DR 2" | J4055H | Puller, Slide Hammer 5 lbs. |
| J000D | Feeler Gauge, 10 Blade Ignition Set | J4205B | Puller, Slotted Cross Arm |
| J2302 | File, Ignition PT | J4206SC | Puller, Slotted Cross Arm |
| JSF150 | Hammer, Soft Face without Tip 1 lb | J4011S | Puller, Spring Clip |
| JSF15XH | Hammer, Tip 1-1/2" Extra Hard | J4021S | Puller, Spring Clip |
| JSF15H | Hammer, Tip 1-1/2" Hard | J4040-1 | Puller, Step Plate 3/4" |
| JSF15M | Hammer, Tip 1-1/2" Medium | J4040-2 | Puller, Step Plate 7/8" |
| JSF15MH | Hammer, Tip 1-1/2" Medium H | J4040-3 | Puller, Step Plate 1" |
| JSF15S | Hammer, Tip 1-1/2" Soft | J4040-4 | Puller, Step Plate 1-1/8" |
| JSF15SS | Hammer, Tip 1-1/2" Super SO | J4040-5 | Puller, Step Plate 1-1/4" |
| JSF15T | Hammer, Tip 1-1/2" Tough | J4040-6 | Puller, Step Plate 1-3/8" |
| 10-189C | Knife, Self-Retracting Utility | J4040-7 | Puller, Step Plate 1-1/2" |
| 42-465 | Level, Aluminum Torpedo Level (Mag) | J4040-8 | Puller, Step Plate 1-5/8" |
| J2371 | Mirror, Inspect Oval 1" x 2" | J4040-9 | Puller, Step Plate 1-3/4" |
| 82-115 | Pick and Hook, 4 PC Set | J4040-10 | Puller, Step Plate 1-7/8" |
| J252G | Pliers, Hose Clamp with Grip 7-3/4" | J4040-11 | Puller, Step Plate 2" |
| J235 | Pliers, Ignition with Grip 4-1/16" | J4040-12 | Puller, Step Plate 2-1/8" |
| J4209JB | Puller, 6 Ton Jaw Block | J4040-13 | Puller, Step Plate 2-1/4" |
| J4210RJ | Puller, 6 Ton Jaw Reversible | J4040-14 | Puller, Step Plate 2-3/8" |
| J4229JB | Puller, 10 Ton Jaw Block | J4012T | Puller, Tip Detachable |
| J4280B | Puller, Blind Bearing Coll | J4022T | Puller, Tip Detachable Standard |
| J4280S | Puller, Blind Bearing Screw | J4250B | Puller, Yoke 2 Way Acme Th |
| J4005C | Puller, Cap Screw | J4255B | Puller, Yoke 3 Way Jaw ACM |
| J4028 | Puller, Cap Screw | J2338 | Scapers, Gasket and Carbon |
| J4226CA | Puller, Crossarm 2 Way | J9853 | Screw Starter, Standard Tip |
| J4227CA | Puller, Crossarm 3 Way | 66-039 | Screwdriver, 6 PC Stanley® Jewelers Precision Set |
| J4208CA | Puller, Crossarm 6 Ton 2 Way | 66-101 | Screwdriver, Stanley® 100 Plus® Standard Slotted Tip Pocket 1/8" x 2" |
| J4260R | Puller, Handle T-Rod Acme | J9320 | Set, 11 PC Screwdriver Magnetic Ratchet |
| J4026A | Puller, Jaw 6 Ton | J334 | Snip, Combination 14" |
| J4027 | Puller, Jaw 6 Ton Narrow | J307 | Snip, Duckbill 7" |
| J4018 | Puller, Jaw 10 Ton Cap Screw | J7412H | Socket, Impact 1/2" DR 3/8" 6 PT |
| J4016A | Puller, Jaw 10 Ton Dual-Reach | J7416H | Socket, Impact 1/2" DR 1/2" 6 PT |
| J4017 | Puller, Jaw 10 Ton Narrow | J7418H | Socket, Impact 1/2" DR 9/16" 6 PT |
| J4230RJ | Puller, Jaw 10 Ton Reversible | J7420H | Socket, Impact 1/2" DR 5/8" 6 PT |
| J4209LS | Puller, Jaw Block Lock Screw | J7422H | Socket, Impact 1/2" DR 11/16" 6 PT |
| J4229LS | Puller, Jaw Block Lock Screw | J7424H | Socket, Impact 1/2" DR 3/4" 6 PT |
| J4056-2 | Puller, Jaw Inside 2 Reach | J7426H | Socket, Impact 1/2" DR 13/16" 6 PT |
| J4256S | Puller, Jaw Inside Hook | J7428H | Socket, Impact 1/2" DR 7/8" 6 PT |
| J4056-4 | Puller, Jaw Reversible 4 R | J7430H | Socket, Impact 1/2" DR 15/16" 6 PT |
| J4056-6 | Puller, Jaw Reversible 6 R | J7432H | Socket, Impact 1/2" DR 1" 6 PT |
| J4250N | Puller, Nut Adjustable Reversible | J7434H | Socket, Impact 1/2" DR 1-1/16" 6 PT |
| J4331N | Puller, Nut Hex | | |





| Contents | Description |
|-----------------|--|
| J7436H | Socket, Impact 1/2" DR 1-1/8" 6 PT |
| J7438H | Socket, Impact 1/2" DR 1-3/16" 6 PT |
| J7440H | Socket, Impact 1/2" DR 1-1/4" 6 PT |
| J7414H | Socket, Impact 1/2" DR 7/16" 6 PT |
| J7410M | Socket, Impact 1/2" DR 10 mm 6 PT |
| J7411M | Socket, Impact 1/2" DR 11 mm 6 PT |
| J7412M | Socket, Impact 1/2" DR 12 mm 6 PT |
| J7413M | Socket, Impact 1/2" DR 13 mm 6 PT |
| J7414M | Socket, Impact 1/2" DR 14 mm 6 PT |
| J7415M | Socket, Impact 1/2" DR 15 mm 6 PT |
| J7416M | Socket, Impact 1/2" DR 16 mm 6 PT |
| J7417M | Socket, Impact 1/2" DR 17 mm 6 PT |
| J7418M | Socket, Impact 1/2" DR 18 mm 6 PT |
| J7419M | Socket, Impact 1/2" DR 19 mm 6 PT |
| J7420M | Socket, Impact 1/2" DR 20 mm 6 PT |
| J7421M | Socket, Impact 1/2" DR 21 mm 6 PT |
| J7422M | Socket, Impact 1/2" DR 22 mm 6 PT |
| J7423M | Socket, Impact 1/2" DR 23 mm 6 PT |
| J7424M | Socket, Impact 1/2" DR 24 mm 6 PT |
| J7312H | Socket, Impact 1/2" DR 3/8" 6 PT Deep |
| J7314H | Socket, Impact 1/2" DR 7/16" 6 PT Deep |
| J7316H | Socket, Impact 1/2" DR 1/2" 6 PT Deep |
| J7318H | Socket, Impact 1/2" DR 9/16" 6 PT Deep |
| J7320H | Socket, Impact 1/2" DR 5/8" 6 PT Deep |
| J7322H | Socket, Impact 1/2" DR 11/16" 6 PT Deep |
| J7324H | Socket, Impact 1/2" DR 3/4" 6 PT Deep |
| J7326H | Socket, Impact 1/2" DR 13/16" 6 PT Deep |
| J7328H | Socket, Impact 1/2" DR 7/8" 6 PT Deep |
| J7330H | Socket, Impact 1/2" DR 15/16" 6 PT Deep |
| J7332H | Socket, Impact 1/2" DR 1" 6 PT Deep |
| J7334H | Socket, Impact 1/2" DR 1-1/16" 6 PT Deep |
| J7336H | Socket, Impact 1/2" DR 1-1/8" 6 PT Deep |
| J7338H | Socket, Impact 1/2" DR 1-3/16" 6 PT Deep |
| J7340H | Socket, Impact 1/2" DR 1-1/4" 6 PT Deep |
| J7342H | Socket, Impact 1/2" DR 1-5/16" 6 PT Deep |
| J7344H | Socket, Impact 1/2" DR 1-3/8" 6 PT Deep |
| J7346H | Socket, Impact 1/2" DR 1-7/16" 6 PT Deep |
| J7348H | Socket, Impact 1/2" DR 1-1/2" 6 PT Deep |
| J7310M | Socket, Impact 1/2" DR 10 mm 6 PT Deep |
| J7311M | Socket, Impact 1/2" DR 11 mm 6 PT Deep |
| J7312M | Socket, Impact 1/2" DR 12 mm 6 PT Deep |
| J7313M | Socket, Impact 1/2" DR 13 mm 6 PT Deep |
| J7314M | Socket, Impact 1/2" DR 14 mm 6 PT Deep |
| J7315M | Socket, Impact 1/2" DR 15 mm 6 PT Deep |
| J7316M | Socket, Impact 1/2" DR 16 mm 6 PT Deep |
| J7317M | Socket, Impact 1/2" DR 17 mm 6 PT Deep |
| J7318M | Socket, Impact 1/2" DR 18 mm 6 PT Deep |
| J7319M | Socket, Impact 1/2" DR 19 mm 6 PT Deep |

| Contents | Description |
|-----------------|--|
| J7320M | Socket, Impact 1/2" DR 20 mm 6 PT Deep |
| J7321M | Socket, Impact 1/2" DR 21 mm 6 PT Deep |
| J7322M | Socket, Impact 1/2" DR 22 mm 6 PT Deep |
| J7323M | Socket, Impact 1/2" DR 23 mm 6 PT Deep |
| J7324M | Socket, Impact 1/2" DR 24 mm 6 PT Deep |
| J07512 | Socket, Impact 3/4" DR 3/4" 6 PT |
| J07513 | Socket, Impact 3/4" DR 13/16" 6 PT |
| J07514 | Socket, Impact 3/4" DR 7/8" 6 PT |
| J07515 | Socket, Impact 3/4" DR 15/16" 6 PT |
| J07516 | Socket, Impact 3/4" DR 1" 6 PT |
| J07517 | Socket, Impact 3/4" DR 1-1/16" 6 PT |
| J07518 | Socket, Impact 3/4" DR 1-1/8" 6 PT |
| J07520 | Socket, Impact 3/4" DR 1-1/4" 6 PT |
| J07519 | Socket, Impact 3/4" DR 1-3/16" 6 PT |
| J07521 | Socket, Impact 3/4" DR 1-5/16" 6 PT |
| J74411/4 | Socket, Impact Hex Bit 1/2" DR 1/4" |
| J74415/16 | Socket, Impact Hex Bit 1/2" DR 5/16" |
| J74413/8 | Socket, Impact Hex Bit 1/2" DR 3/8" |
| J74417/16 | Socket, Impact Hex Bit 1/2" DR 7/16" |
| J74411/2 | Socket, Impact Hex Bit 1/2" DR 1/2" |
| J74419/16 | Socket, Impact Hex Bit 1/2" DR 9/16" |
| J74415/8 | Socket, Impact Hex Bit 1/2" DR 5/8" |
| 55-515 | Wonder Bar® 13-3/8" |
| J3210 | Wrench, Angle 13/64" x 15/64" Short |
| J3215 | Wrench, Angle 7/32" x 1/4" Short |
| J3211 | Wrench, Angle 15/64" x 13/64" Short |
| J3216 | Wrench, Angle 1/4" x 7/32" Short |
| J3220 | Wrench, Angle 9/32" x 5/16" Short |
| J3221 | Wrench, Angle 5/16" x 9/32" Short |
| J3225 | Wrench, Angle 11/32" x 3/8" Short |
| J3226 | Wrench, Angle 3/8" x 11/32" Short |
| J5330CF | Wrench, Open End Crowfoot 1/2" DR 15/16" |
| J5332CF | Wrench, Open End Crowfoot 1/2" DR 1" |
| J5334CF | Wrench, Open End Crowfoot 1/2" DR 1-1/16" |
| J5336CF | Wrench, Open End Crowfoot 1/2" DR 1-1/8" |
| J5338CF | Wrench, Open End Crowfoot 1/2" DR 1-3/16" |
| J5340CF | Wrench, Open End Crowfoot 1/2" DR 1-1/4" |
| J5342CF | Wrench, Open End Crowfoot 1/2" DR 1-5/16" |
| J5344CF | Wrench, Open End Crowfoot 1/2" DR 1-3/8" |
| J5346CF | Wrench, Open End Crowfoot 1/2" DR 1-7/16" |
| J5348CF | Wrench, Open End Crowfoot 1/2" DR 1-1/2" |
| J5350CF | Wrench, Open End Crowfoot 1/2" DR 1-9/16" |
| J5352CF | Wrench, Open End Crowfoot 1/2" DR 1-5/8" |
| J5354CF | Wrench, Open End Crowfoot 1/2" DR 1-11/16" |
| J5356CF | Wrench, Open End Crowfoot 1/2" DR 1-3/4" |
| J5358CF | Wrench, Open End Crowfoot 1/2" DR 1-13/16" |
| J5360CF | Wrench, Open End Crowfoot 1/2" DR 1-7/8" |

MODULAR SET 7

Product #: JCS-MAS-7



► Weight: 109.87 lbs.



| Contents | Description |
|-----------|--|
| J77270P | Adapter, Universal Joint 3/8" DR |
| J74470P | Adapter, Universal Joint 1/2" DR |
| J406 | C-Clamp, 0-6 |
| J4759L | Extension, Locking 1/4" DR 2" |
| J5262L | Extension, Locking 3/8" DR 12" |
| J5461L | Extension, Locking 1/2" DR 5" |
| J4759W | Extension, Wobble 1/4" DR 2" |
| J5461W | Extension, Wobble 1/2" DR 5" |
| J5463W | Extension, Wobble 1/2" DR 10" |
| J000AA | Feeler Gauge, 25 Blade Master Set |
| 20-001 | Stanley® Hacksaw, High Tension Low Profile 12" |
| 15-809 | Stanley® Hacksaw, Metal Mini |
| 57-531 | Hammer, Compo-Cast® Mallet 18 oz. |
| 57-541 | Hammer, Compo-Cast® Soft Face 14 oz. |
| 57-543 | Hammer, Compo-Cast® Soft Face 21 oz. |
| JSF250 | Hammer, Soft-Face without Tips |
| JSF25XH | Hammer, Tip 2-1/2" Extra Hard |
| JSF25H | Hammer, Tip 2-1/2" Hard |
| JSF25M | Hammer, Tip 2-1/2" Medium |
| JSF25MH | Hammer, Tip 2-1/2" Medium Hard |
| JSF25T | Hammer, Tip 2-1/2" Tough |
| J4969 | Hex Key, 6 PC Metric T-Handle Set |
| J4968 | Hex Key, 11 PC Standard T-Handle Set |
| J2806SMP | Pliers, 6 PC Mini Set |
| J4749XL | Ratchet, 1/4" DR Standard Length Premium Pear Head |
| J5450XL | Ratchet, 1/2" DR Long Handle Pear Head |
| J5250XL | Ratchet, 3/8" DR Long Handle Pear Head |
| J5249XL | Ratchet, 3/8" DR Standard Length Premium Pear Head |
| J5449XL | Ratchet, 1/2" DR Standard Length Premium Pear Head |
| J9300MS | Screwdriver, Magnetic Bit Holder |
| J88510 | Screwdriver, Torx® T10 |
| J88515 | Screwdriver, Torx® T15 |
| J88520 | Screwdriver, Torx® T20 |
| J88525 | Screwdriver, Torx® T25 |
| J88527 | Screwdriver, Torx® T27 |
| J88530 | Screwdriver, Torx® T30 |
| J88540 | Screwdriver, Torx® T40 |
| J303L | Snip, Aviation Left |
| J303R | Snip, Aviation Right |
| J4705 | Socket, 1/4" DR 5/32" 6 PT |
| J4705LTM | Socket, 1/4" DR 5 mm 12 PT Deep |
| J47055LTM | Socket, 1/4" DR 5.5 mm 12 PT Deep |
| J4706LTM | Socket, 1/4" DR 6 mm 12 PT Deep |
| J4707LTM | Socket, 1/4" DR 7 mm 12 PT Deep |
| J4708LTM | Socket, 1/4" DR 8 mm 12 PT Deep |
| J4709LTM | Socket, 1/4" DR 9 mm 12 PT Deep |
| J4710LTM | Socket, 1/4" DR 10 mm 12 PT Deep |
| J4711LTM | Socket, 1/4" DR 11 mm 12 PT Deep |
| J4712LTM | Socket, 1/4" DR 12 mm 12 PT Deep |
| J4713LTM | Socket, 1/4" DR 13 mm 12 PT Deep |
| J4714LTM | Socket, 1/4" DR 14 mm 12 PT Deep |
| J5208H | Socket, 3/8" DR 1/4" 6 PT |
| J5206H | Socket, 3/8" DR 3/16" 6 PT |

| Contents | Description |
|----------|---|
| J5210H | Socket, 3/8" DR 5/16" 6 PT |
| J5212H | Socket, 3/8" DR 3/8" 6 PT |
| J5214H | Socket, 3/8" DR 7/16" 6 PT |
| J5216H | Socket, 3/8" DR 1/2" 6 PT |
| J5218H | Socket, 3/8" DR 9/16" 6 PT |
| J5220H | Socket, 3/8" DR 5/8" 6 PT |
| J5222H | Socket, 3/8" DR 11/16" 6 PT |
| J5224H | Socket, 3/8" DR 3/4" 6 PT |
| J5226H | Socket, 3/8" DR 13/16" 6 PT |
| J5228H | Socket, 3/8" DR 7/8" 6 PT |
| J5230H | Socket, 3/8" DR 15/16" 6 PT |
| J5232H | Socket, 3/8" DR 1" 6 PT |
| J5221MH | Socket, 3/8" DR 21 mm 6 PT |
| J5222MH | Socket, 3/8" DR 22 mm 6 PT |
| J5223MH | Socket, 3/8" DR 23 mm 6 PT |
| J5224MH | Socket, 3/8" DR 24 mm 6 PT |
| J5225MH | Socket, 3/8" DR 25 mm 6 PT |
| J5226MH | Socket, 3/8" DR 26 mm 6 PT |
| J5008H | Socket, 3/8" DR 1/4" 6 PT Deep |
| J5010H | Socket, 3/8" DR 5/16" 6 PT Deep |
| J5012H | Socket, 3/8" DR 3/8" 6 PT Deep |
| J5014H | Socket, 3/8" DR 7/16" 6 PT Deep |
| J5016H | Socket, 3/8" DR 1/2" 6 PT Deep |
| J5018H | Socket, 3/8" DR 9/16" 6 PT Deep |
| J5020H | Socket, 3/8" DR 5/8" 6 PT Deep |
| J5022H | Socket, 3/8" DR 11/16" 6 PT Deep |
| J5024H | Socket, 3/8" DR 3/4" 6 PT Deep |
| J5026H | Socket, 3/8" DR 13/16" 6 PT Deep |
| J5028H | Socket, 3/8" DR 7/8" 6 PT Deep |
| J5030H | Socket, 3/8" DR 15/16" 6 PT Deep |
| J5032H | Socket, 3/8" DR 1" 6 PT Deep |
| J5206HS | Socket, 3/8" DR 3/16" 6 PT Super Short |
| J5208HS | Socket, 3/8" DR 1/4" 6 PT Super Short |
| J5210HS | Socket, 3/8" DR 5/16" 6 PT Super Short |
| J5212HS | Socket, 3/8" DR 3/8" 6 PT Super Short |
| J5214HS | Socket, 3/8" DR 7/16" 6 PT Super Short |
| J5216HS | Socket, 3/8" DR 1/2" 6 PT Super Short |
| J5218HS | Socket, 3/8" DR 9/16" 6 PT Super Short |
| J5220HS | Socket, 3/8" DR 5/8" 6 PT Super Short |
| J5222HS | Socket, 3/8" DR 11/16" 6 PT Super Short |
| J5224HS | Socket, 3/8" DR 3/4" 6 PT Super Short |
| J5209MHS | Socket, 3/8" DR 9 mm 6 PT Super Short |
| J5210MHS | Socket, 3/8" DR 10 mm 6 PT Super Short |
| J5211MHS | Socket, 3/8" DR 11 mm 6 PT Super Short |
| J5212MHS | Socket, 3/8" DR 12 mm 6 PT Super Short |
| J5213MHS | Socket, 3/8" DR 13 mm 6 PT Super Short |
| J5214MHS | Socket, 3/8" DR 14 mm 6 PT Super Short |
| J5215MHS | Socket, 3/8" DR 15 mm 6 PT Super Short |
| J5216MHS | Socket, 3/8" DR 16 mm 6 PT Super Short |
| J5217MHS | Socket, 3/8" DR 17 mm 6 PT Super Short |
| J5218MHS | Socket, 3/8" DR 18 mm 6 PT Super Short |
| J5219MHS | Socket, 3/8" DR 19 mm 6 PT Super Short |
| J5221M | Socket, 3/8" DR 21 mm 12 PT |
| J5222M | Socket, 3/8" DR 22 mm 12 PT |





| Contents | Description |
|-----------------|-------------------------------------|
| J5223M | Socket, 3/8" DR 23 mm 12 PT |
| J5224M | Socket, 3/8" DR 24 mm 12 PT |
| J5225M | Socket, 3/8" DR 25 mm 12 PT |
| J5226M | Socket, 3/8" DR 26 mm 12 PT |
| J5006M | Socket, 3/8" DR 6 mm 12 PT Deep |
| J5021M | Socket, 3/8" DR 21 mm 12 PT Deep |
| J5022M | Socket, 3/8" DR 22 mm 12 PT Deep |
| J5023M | Socket, 3/8" DR 23 mm 12 PT Deep |
| J5412H | Socket, 1/2" DR 3/8" 6 PT |
| J5414H | Socket, 1/2" DR 7/16" 6 PT |
| J5416H | Socket, 1/2" DR 1/2" 6 PT |
| J5418H | Socket, 1/2" DR 9/16" 6 PT |
| J5420H | Socket, 1/2" DR 5/8" 6 PT |
| J5422H | Socket, 1/2" DR 11/16" 6 PT |
| J5424H | Socket, 1/2" DR 3/4" 6 PT |
| J5426H | Socket, 1/2" DR 13/16" 6 PT |
| J5428H | Socket, 1/2" DR 7/8" 6 PT |
| J5430H | Socket, 1/2" DR 15/16" 6 PT |
| J5432H | Socket, 1/2" DR 1" 6 PT |
| J5434H | Socket, 1/2" DR 1-1/16" 6 PT |
| J5436H | Socket, 1/2" DR 1-1/8" 6 PT |
| J5438H | Socket, 1/2" DR 1-3/16" 6 PT |
| J5440H | Socket, 1/2" DR 1-1/4" 6 PT |
| J5312H | Socket, 1/2" DR 3/8" 6 PT Deep |
| J5314H | Socket, 1/2" DR 7/16" 6 PT Deep |
| J5316H | Socket, 1/2" DR 1/2" 6 PT Deep |
| J5318H | Socket, 1/2" DR 9/16" 6 PT Deep |
| J5320H | Socket, 1/2" DR 5/8" 6 PT Deep |
| J5322H | Socket, 1/2" DR 11/16" 6 PT Deep |
| J5324H | Socket, 1/2" DR 3/4" 6 PT Deep |
| J5326H | Socket, 1/2" DR 13/16" 6 PT Deep |
| J5328H | Socket, 1/2" DR 7/8" 6 PT Deep |
| J5330H | Socket, 1/2" DR 15/16" 6 PT Deep |
| J5332H | Socket, 1/2" DR 1" 6 PT Deep |
| J5334H | Socket, 1/2" DR 1-1/16" 6 PT Deep |
| J5336H | Socket, 1/2" DR 1-1/8" 6 PT Deep |
| J5338H | Socket, 1/2" DR 1-3/16" 6 PT Deep |
| J5340H | Socket, 1/2" DR 1-1/4" 6 PT Deep |
| J5342H | Socket, 1/2" DR 1-5/16" 6 PT Deep |
| J5344H | Socket, 1/2" DR 1-3/8" 6 PT Deep |
| J5346H | Socket, 1/2" DR 1-7/16" 6 PT Deep |
| J5348H | Socket, 1/2" DR 1-1/2" 6 PT Deep |
| J4739-10W | Socket, Bit 1/4" DR T10 Torx® |
| J4739-15W | Socket, Bit 1/4" DR T15 Torx® |
| J4739-20W | Socket, Bit 1/4" DR T20 Torx® |
| J4739-25W | Socket, Bit 1/4" DR T25 Torx® |
| J4739-27W | Socket, Bit 1/4" DR T27 Torx® |
| J4739-30W | Socket, Bit 1/4" DR T30 Torx® |
| J5239-20W | Socket, Bit 3/8" DR T20 Torx® |
| J5239-15W | Socket, Bit 3/8" DR T15 Torx® |
| J5239-25W | Socket, Bit 3/8" DR T25 Torx® |
| J5239-27W | Socket, Bit 3/8" DR T27 Torx® |
| J5239-30W | Socket, Bit 3/8" DR T30 Torx® |
| J5239-40W | Socket, Bit 3/8" DR T40 Torx® |
| J5239-45W | Socket, Bit 3/8" DR T45 Torx® |
| J5239-50W | Socket, Bit 3/8" DR T50 Torx® |
| J4990-4MXL | Socket, Hex Bit 3/8" DR 4 mm X-Long |
| J4990-5MXL | Socket, Hex Bit 3/8" DR 5 mm X-Long |

| Contents | Description |
|-----------------|---|
| J4990-6MXL | Socket, Hex Bit 3/8" DR 6 mm X-Long |
| J4990-7MXL | Socket, Hex Bit 3/8" DR 7 mm X-Long |
| J4990-8MXL | Socket, Hex Bit 3/8" DR 8 mm X-Long |
| J4990-10MXL | Socket, Hex Bit 3/8" DR 10 mm X-Long |
| J54411/4XL | Socket, Hex Bit 1/2" DR 1/4" X-Long |
| J54415/16XL | Socket, Hex Bit 1/2" DR 5/16" X-Long |
| J54413/8XL | Socket, Hex Bit 1/2" DR 3/8" X-Long |
| J54411/2XL | Socket, Hex Bit 1/2" DR 1/2" X-Long |
| J54419/16XL | Socket, Hex Bit 1/2" DR 9/16" X-Long |
| J54415/8XL | Socket, Hex Bit 1/2" DR 5/8" X-Long |
| J7316HT | Socket, Impact 1/2" DR 1/2" Thin Wall |
| J7318HT | Socket, Impact 1/2" DR 9/16" Thin Wall |
| J7320HT | Socket, Impact 1/2" DR 5/8" Thin Wall |
| J7322HT | Socket, Impact 1/2" DR 11/16" Thin Wall |
| J7324HT | Socket, Impact 1/2" DR 3/4" Thin Wall |
| J7326HT | Socket, Impact 1/2" DR 13/16" Thin Wall |
| J7328HT | Socket, Impact 1/2" DR 7/8" Thin Wall |
| J7330HT | Socket, Impact 1/2" DR 15/16" Thin Wall |
| J7332HT | Socket, Impact 1/2" DR 1" Thin Wall |
| J7334HT | Socket, Impact 1/2" DR 1-1/16" Thin Wall |
| J7336HT | Socket, Impact 1/2" DR 1-1/8" Thin Wall |
| J7338HT | Socket, Impact 1/2" DR 1-3/16" Thin Wall |
| J7340HT | Socket, Impact 1/2" DR 1-1/4" Thin Wall |
| J7314MHT | Socket, Impact 1/2" DR 14 mm Thin Wall |
| J7315MHT | Socket, Impact 1/2" DR 15 mm Thin Wall |
| J7316MHT | Socket, Impact 1/2" DR 16 mm Thin Wall |
| J7317MHT | Socket, Impact 1/2" DR 17 mm Thin Wall |
| J7318MHT | Socket, Impact 1/2" DR 18 mm Thin Wall |
| J7319MHT | Socket, Impact 1/2" DR 19 mm Thin Wall |
| J7320MHT | Socket, Impact 1/2" DR 20 mm Thin Wall |
| J7321MHT | Socket, Impact 1/2" DR 21 mm Thin Wall |
| J7322MHT | Socket, Impact 1/2" DR 22 mm Thin Wall |
| J7323MHT | Socket, Impact 1/2" DR 23 mm Thin Wall |
| J7324MHT | Socket, Impact 1/2" DR 24 mm Thin Wall |
| J7312HT | Socket, Impact 1/2" DR 3/8" Deep Thin Wall |
| J7314HT | Socket, Impact 1/2" DR 7/16" Deep Thin Wall |
| J7008MHT | Socket, Impact 3/8" DR 8 mm Deep Thin Wall |
| J7009MHT | Socket, Impact 3/8" DR 9 mm Deep Thin Wall |
| J7310MHT | Socket, Impact 1/2" DR 10 mm Deep Thin Wall |
| J7311MHT | Socket, Impact 1/2" DR 11 mm Deep Thin Wall |
| J7312MHT | Socket, Impact 1/2" DR 12 mm Deep Thin Wall |
| J7313MHT | Socket, Impact 1/2" DR 13 mm Deep Thin Wall |
| J7010MHT | Socket, Impact 3/8" DR 10 mm Deep Thin Wall |
| J7011MHT | Socket, Impact 3/8" DR 11 mm Deep Thin Wall |
| J7012MHT | Socket, Impact 3/8" DR 12 mm Deep Thin Wall |
| J7013MHT | Socket, Impact 3/8" DR 13 mm Deep Thin Wall |
| J7014MHT | Socket, Impact 3/8" DR 14 mm Deep Thin Wall |
| J7015MHT | Socket, Impact 3/8" DR 15 mm Deep Thin Wall |
| J7016MHT | Socket, Impact 3/8" DR 16 mm Deep Thin Wall |
| J7017MHT | Socket, Impact 3/8" DR 17 mm Deep Thin Wall |
| J7018MHT | Socket, Impact 3/8" DR 18 mm Deep Thin Wall |
| J7019MHT | Socket, Impact 3/8" DR 19 mm Deep Thin Wall |
| J7708HT | Socket, Impact 3/8" DR 1/4" Deep Thin Wall |
| J7710HT | Socket, Impact 3/8" DR 5/16" Deep Thin Wall |
| J7712HT | Socket, Impact 3/8" DR 3/8" Deep Thin Wall |
| J7714HT | Socket, Impact 3/8" DR 7/16" Deep Thin Wall |
| J7716HT | Socket, Impact 3/8" DR 1/2" Deep Thin Wall |
| J7718HT | Socket, Impact 3/8" DR 9/16" Deep Thin Wall |

(CONTINUED ON NEXT PAGE)

MODULAR SET 7 (CONTINUED)

Product #: **JCS-MAS-7**



| Contents | Description |
|----------|--|
| J7720HT | Socket, Impact 3/8" DR 5/8" Deep Thin Wall |
| J7722HT | Socket, Impact 3/8" DR 11/16" Deep Thin Wall |
| J7724HT | Socket, Impact 3/8" DR 3/4" Deep Thin Wall |
| J48055AM | Socket, Universal 1/4" DR 5.5 mm 6 PT |
| J4805AM | Socket, Universal 1/4" DR 5 mm 6 PT |
| J4806AM | Socket, Universal 1/4" DR 6 mm 6 PT |
| J4807AM | Socket, Universal 1/4" DR 7 mm 6 PT |
| J4808AM | Socket, Universal 1/4" DR 8 mm 6 PT |
| J4809AM | Socket, Universal 1/4" DR 9 mm 6 PT |
| J4810AM | Socket, Universal 1/4" DR 10 mm 6 PT |
| J4811AM | Socket, Universal 1/4" DR 11 mm 6 PT |
| J4812AM | Socket, Universal 1/4" DR 12 mm 6 PT |
| J4813AM | Socket, Universal 1/4" DR 13 mm 6 PT |
| J4814AM | Socket, Universal 1/4" DR 14 mm 6 PT |
| J5281AM | Socket, Universal 3/8" DR 18 mm 12 PT |
| J5282AM | Socket, Universal 3/8" DR 19 mm 12 PT |

| Contents | Description |
|----------|--|
| J4815AM | Socket, Universal 1/4" DR 15 mm 6 PT |
| J5270HAM | Socket, Universal 3/8" DR 7 mm 6 PT |
| 95-112W | Flashlight, Stanley® Tripod - 20 Lumens |
| TR250 | Stapler / Brad Nailer, Heavy-Duty Aluminum |
| TRA706T | Staples, Heavy-Duty 3/8" - 1,000 Pack |
| 33-725 | Tape Rule, FatMax® 1-1/4" x 25' |
| J5362FL | Wrench, Crowfoot 1/2" DR 1-15/16" |
| J5364FL | Wrench, Crowfoot 1/2" DR 2" |
| J5364CF | Wrench, Open End Crowfoot 1/2" DR 2" |
| J5368CF | Wrench, Open End Crowfoot 1/2" DR 2-1/8" |
| J5372CF | Wrench, Open End Crowfoot 1/2" DR 2-1/4" |
| J5376CF | Wrench, Open End Crowfoot 1/2" DR 2-3/8" |
| J5378CF | Wrench, Open End Crowfoot 1/2" DR 2-7/16" |
| J5380CF | Wrench, Open End Crowfoot 1/2" DR 2-1/2" |
| J6064C | Wrench, Torque 3/8" DR 40-200 in-lbs |

MODULAR SET FOR JCS-0613MAS

Product #: **JCS-MOD613**



► Weight: 9.72 lbs.

| Contents | Description |
|----------|----------------------------------|
| J404 | C-Clamps, Capacity 0"-4", 2 Each |
| 15-265 | Hacksaw, 3-7/8" |
| J4749 | Ratchet, 1/4" DR |

| Contents | Description |
|----------|--------------------------------|
| J5249 | Ratchet, 3/8" DR |
| J5449 | Ratchet, 1/2" DR |
| J5450 | Ratchet, 1/2" DR (Long Handle) |



MODULAR SET FOR JCS-0833MAS

Product #: **JCS-MOD833**



› Weight: 40.78 lbs.

| Contents | Description |
|----------|-------------------------------------|
| 9000-10 | Bit, 1/4" x 1" |
| 9000-8 | Bit, for P1 1/4" x 1" |
| 9000-9 | Bit, for P2 1/4" x 1" |
| J60050 | Bit, Insert #1 Phillips® 5/16" Hex |
| J60052 | Bit, Insert #2 Phillips® 5/16" Hex |
| J60054 | Bit, Insert #3 Phillips® 5/16" Hex |
| J6931 | Bit, Holder Power 3/8" DR 1/4" Hex |
| J6930 | Bit, Holder Power 3/8" DR 5/16" Hex |
| 9000-6 | Bit, Insert Slotted 3/16" #4 |
| 9000-7 | Bit, Insert Slotted 1/4" x 7/8" |
| 9000-11 | Bit, Insert Slotted 5/16" x 1-1/2" |
| 9000-12 | Bit, Insert Slotted 5/16" x 1-1/2" |
| J4019 | Box, Puller Set |
| 15-265 | Hacksaw, 3-7/8" |
| J4209JB | Puller, 6 Ton Jaw Block |
| J4210RJ | Puller, 6 Ton Jaw Reversible |
| J4229JB | Puller, 10 Ton Jaw Block |
| J4280B | Puller, Blind Bearing Coll |
| J4208CA | Puller, Crossarm 6 Ton 2 Way |
| J4227CA | Puller, Crossarm 3 Way |
| J4260R | Puller, Handle T-Rod Acme |
| J4230RJ | Puller, Jaw 10 Ton Reversible |
| J4209LS | Puller, Jaw Block Lock Screw |
| J4229LS | Puller, Jaw Block Lock Screw |

| Contents | Description |
|-----------|-----------------------------------|
| J4056PN | Puller, Pin Pivot |
| J4275R | Puller, Rod Slide Acme Threader |
| J4205S | Puller, Screw Forcing Acme |
| J4225S | Puller, Screw Forcing Acme |
| J4260H | Puller, Slide Hammer 2-1/2" |
| J4055H | Puller, Slide Hammer 5 lbs. |
| J4012T | Puller, Tip Detachable |
| J4022T | Puller, Tip Detachable Standard |
| J4749 | Ratchet, 1/4" DR |
| J5249 | Ratchet, 3/8" DR |
| J5449 | Ratchet, 1/2" DR |
| J5450 | Ratchet, 1/2" DR (Long Handle) |
| J4705LTM | Socket, 1/4" DR 5 mm 12 PT Deep |
| J47055LTM | Socket, 1/4" DR 5.5 mm 12 PT Deep |
| J4706LTM | Socket, 1/4" DR 6 mm 12 PT Deep |
| J4707LTM | Socket, 1/4" DR 7 mm 12 PT Deep |
| J4708LTM | Socket, 1/4" DR 8 mm 12 PT Deep |
| J4709LTM | Socket, 1/4" DR 9 mm 12 PT Deep |
| J4710LTM | Socket, 1/4" DR 10 mm 12 PT Deep |
| J4711LTM | Socket, 1/4" DR 11 mm 12 PT Deep |
| J4712LTM | Socket, 1/4" DR 12 mm 12 PT Deep |
| J4713LTM | Socket, 1/4" DR 13 mm 12 PT Deep |
| J4714LTM | Socket, 1/4" DR 14 mm 12 PT Deep |

MODULAR SET FOR JCS-1046MAS

Product #: **JCSMOD1046**



› Weight: 10.2 lbs.

| Contents | Description |
|----------|-------------------------------------|
| 9000-10 | Bit, 1/4" x 1" |
| 9000-8 | Bit, for P1 1/4" x 1" |
| 9000-9 | Bit, for P2 1/4" x 1" |
| J6931 | Bit, Holder Power 3/8" DR 1/4" Hex |
| J6930 | Bit, Holder Power 3/8" DR 5/16" Hex |
| J60050 | Bit, Insert #1 Phillips® 5/16" Hex |
| J60052 | Bit, Insert #2 Phillips® 5/16" Hex |
| J60054 | Bit, Insert #3 Phillips® 5/16" Hex |
| 9000-6 | Bit, Insert Slotted 3/16" #4 |
| 9000-7 | Bit, Insert Slotted 1/4" x 7/8" |
| 9000-11 | Bit, Insert Slotted 5/16" x 1-1/2" |
| 9000-12 | Bit, Insert Slotted 5/16" x 1-1/2" |
| 15-265 | Hacksaw, 3-7/8" |
| J4749 | Ratchet, 1/4" DR |
| J5249 | Ratchet, 3/8" DR |
| J5449 | Ratchet, 1/2" DR |
| J5450 | Ratchet, 1/2" DR (Long Handle) |
| J4705LTM | Socket, 1/4" DR 5 mm 12 PT Deep |

| Contents | Description |
|-----------|--|
| J47055LTM | Socket, 1/4" DR 5.5 mm 12 PT Deep |
| J4706LTM | Socket, 1/4" DR 6 mm 12 PT Deep |
| J4707LTM | Socket, 1/4" DR 7 mm 12 PT Deep |
| J4708LTM | Socket, 1/4" DR 8 mm 12 PT Deep |
| J4709LTM | Socket, 1/4" DR 9 mm 12 PT Deep |
| J4710LTM | Socket, 1/4" DR 10 mm 12 PT Deep |
| J4711LTM | Socket, 1/4" DR 11 mm 12 PT Deep |
| J4712LTM | Socket, 1/4" DR 12 mm 12 PT Deep |
| J4713LTM | Socket, 1/4" DR 13 mm 12 PT Deep |
| J4714LTM | Socket, 1/4" DR 14 mm 12 PT Deep |
| J4708CF | Wrench, Crowfoot 1/4" DR 1/4" Open End |
| J4710CF | Wrench, Crowfoot 1/4" DR 5/16" Open End |
| J4712CF | Wrench, Crowfoot 1/4" DR 3/8" Open End |
| J4714CF | Wrench, Crowfoot 1/4" DR 7/16" Open End |
| J4716CF | Wrench, Crowfoot 1/4" DR 1/2" Open End |
| J4718CF | Wrench, Crowfoot 1/4" DR 9/16" Open End |
| J4930CF | Wrench, Crowfoot 3/8" DR 15/16" Open End |
| J4932CF | Wrench, Crowfoot 3/8" DR 1" Open End |



453 PC INTERMEDIATE TOOL SET

Product #: J99720



- › 453 Pieces.
- › 1/4", 3/8", 1/2", 3/4" Drive Tools.
- › Designed for fastener sizes 3/16" - 2-3/8".
- › Tools only.
- › Contains: 212 Sockets and Accessories, 105 Wrenches, 34 Striking and Struck Tools, 32 Pliers, 32 Screwdrivers, 38 Miscellaneous Tools.
- › Weight: 280.0 lbs.



Representative Image; Contents May Differ





| Contents | Description |
|-----------------|----------------------------------|
| J4770A | Adapter, Universal Joint 1/4" DR |
| J5270A | Adapter, Universal Joint 3/8" DR |
| J5470A | Adapter, Universal Joint 1/2" DR |
| J5670 | Adapter, Universal Joint 3/4" DR |
| J2126 | Bar, 12" Long 1/2" Tip |
| J2130 | Bar, 16" Long 5/8" Tip |
| J2120 | Bar, Pry Aligning 18" |
| J2124 | Bar, Pry Aligning 24" |
| J47707/64 | Bit, 1/4" DR 7/64" Hex |
| J404 | C-Clamps, Capacity 0"-4", 2 Each |
| J86A3/16 | Chisel, Cold 1/4" |
| J86A1/4 | Chisel, Cold 5/16" |
| J86A5/16 | Chisel, Cold 3/8" |
| J86A7/16 | Chisel, Cold 1/2" |
| J86A1/2 | Chisel, Cold 5/8" |
| J86A5/8 | Chisel, Cold 3/4" |
| J86A3/4X8 | Chisel, Cold 7/8" |
| J86A7/8X8 | Chisel, Cold 1" |
| J86A1X8 | Chisel, Cold 1-3/16" |
| J4769 | Driver, 1/4" DR |
| J9521 | Extractor, Screw 1/8" |
| J9522 | Extractor, Screw 3/16" |
| J9523 | Extractor, Screw 15/64" |
| J9524 | Extractor, Screw 5/16" |
| J9525 | Extractor, Screw 3/8" |
| J9525B | Extractor, Screw 15/32" |
| J9526 | Extractor, Screw 9/16" |
| J9527 | Extractor, Screw 21/32" |
| J9528 | Extractor, Screw 13/16" |
| J9529 | Extractor, Screw 1-1/16" |
| J4759 | Extension, 1/4" DR 2" |
| J4760 | Extension, 1/4" DR 3" |
| J4761 | Extension, 1/4" DR 6" |
| J5260 | Extension, 3/8" DR 3" |
| J5260-06 | Extension, 3/8" DR 6" |
| J5262 | Extension, 3/8" DR 12" |
| J5460 | Extension, 1/2" DR 2-1/2" |
| J5461 | Extension, 1/2" DR 5" |
| J5463 | Extension, 1/2" DR 10" |
| J5660 | Extension, 3/4" DR 4" |
| J5661 | Extension, 3/4" DR 8" |
| J5663 | Extension, 3/4" DR 16" |
| J4765 | Extension, Flex 1/4" DR 6-1/4" |
| J5268 | Extension, Flex 3/8" DR 8" |
| J5260W | Extension, Wobble 3/8" DR 3" |
| J5260-06W | Extension, Wobble 3/8" DR 6" |
| J5696 | Box, Extra Heavy-Duty Set |
| 15-265 | Hacksaw, 3-7/8" |
| J1430-HB | Hammer Head |
| J1308PD | Hammer, Ball Pein 8 oz. |
| J1316PD | Hammer, Ball Pein 16 oz. |
| J1332PD | Hammer, Ball Pein 32 oz. |
| 57-532 | Hammer, Compo-Cast® 21 oz. |
| 57-534 | Hammer, Compo-Cast® 52 oz. |
| J4766 | Handle, Hinge 1/4" DR 5-3/4" |
| J5265 | Handle, Hinge 3/8" DR 8-1/2" |
| J5468 | Handle, Hinge 1/2" DR |
| J5668 | Handle, Hinge 3/4" DR 20" |

| Contents | Description |
|-----------------|---|
| J4785 | Handle, Sliding T 1/4" DR |
| J5285 | Handle, Sliding T 3/8" DR |
| J5485 | Handle, Sliding T 1/2" DR |
| J5685 | Handle, Sliding T 3/4" DR |
| J4780G | Handle, Speed 1/4" DR |
| J5280G | Handle, Speed 3/8" DR |
| J5480G | Handle, Speed 1/2" DR |
| J4980 | Hex Key, 13 PC Standard Set |
| J2108 | Holder, Punch and Chisel |
| J95218 | Knife, Folding Blade |
| J18545B | Knife, Lockback 5" |
| 10-099 | Knife, Stanley® Classic 99® Retractable Blade Utility |
| J1368 | Mallet, Rubber |
| J308 | Miniature Snips |
| J2373 | Mirror, Rectangular Telescoping 2-1/8" |
| J9206 | Nut Driver, 3/16" |
| J9207 | Nut Driver, 7/32" |
| J9208 | Nut Driver, 1/4" |
| J9209 | Nut Driver, 9/32" |
| J9210 | Nut Driver, 5/16" |
| J9211 | Nut Driver, 11/32" |
| J9212 | Nut Driver, 3/8" |
| J9214 | Nut Driver 7/16" |
| J9216 | Nut Driver, 1/2" |
| J9218 | Nut Driver, 9/16" |
| J9220 | Nut Driver, 5/8" |
| J206G | Pliers, Diagonal Cutting with Grip 6-1/16" |
| J209G | Pliers, Diagonal Cutting with Grip 7-5/16" |
| J227G | Pliers, Duckbill with Grip 7-25/32" |
| J272G | Pliers, End Cutting High Leverage 8-1/4" |
| J268G | Pliers, Lineman's with Grip 8-5/8" |
| J292NC | Pliers, Locking Curved 10" |
| J286LNXL | Pliers, Locking Mini Long Nose 6-29/32" |
| J291NC | Pliers, Locking Straight 7" |
| J225G | Pliers, Needle-Nose Bent Nose 6-5/16" |
| J222G | Pliers, Needle-Nose Long Thin 6-1/16" |
| J226G | Pliers, Needle-Nose with Cutter 6-5/8" |
| J360B | Pliers, 12 PC Set Convertible Retaining Ring |
| J276G | Pliers, Slip-Joint with Grip 6-9/16" |
| J278G | Pliers, Slip-Joint with Grip 8-1/16" |
| J261SG | Pliers, Tongue and Groove 5" with Grip |
| J262SG | Pliers, Tongue and Groove 6-1/2" with Grip |
| J260SG | Pliers, Tongue and Groove 10-3/16" with Grip |
| J265SG | Pliers, Tongue and Groove 16" with Grip |
| J298 | Pliers, Wire Strippers 8-1/4" |
| J2306 | Puller, Cotter Pin Tool |
| J4056-4 | Puller, Jaw Reversible 4 R |
| J4250N | Puller, Nut Adjustable Reversible |
| J4056PN | Puller, Pin Pivot |
| J4205S | Puller, Screw Forcing Acme |
| J4022T | Puller, Tip Detachable Standard |
| J4255B | Puller, Yoke 3 Way Jaw ACM |
| J413/8 | Punch, Center 3/8" |
| J411/2 | Punch, Center 1/2" |
| J965/16 | Punch, Drift 1/8" |
| J963/8 | Punch, Drift 3/16" |
| J961/2 | Punch, Drift 1/4" |
| J471/4X3/32 | Punch, Pin 3/32" |

(CONTINUED ON NEXT PAGE)

453 PC INTERMEDIATE TOOL SET (CONTINUED)

Product #: **J99720**



| Contents | Description | Contents | Description |
|--------------|--|----------|-----------------------------------|
| J475/16X1/8 | Punch, Pin 1/8" | J4706L | Socket, 1/4" DR 3/16" 6 PT Deep |
| J475/16X5/32 | Punch, Pin 5/32" | J4707L | Socket, 1/4" DR 7/32" 6 PT Deep |
| J473/8X3/16 | Punch, Pin 3/16" | J4708L | Socket, 1/4" DR 1/4" 6 PT Deep |
| J477/16X7/32 | Punch, Pin 7/32" | J4709L | Socket, 1/4" DR 9/32" 6 PT Deep |
| J471/2X1/4 | Punch, Pin 1/4" | J4710L | Socket, 1/4" DR 5/16" 6 PT Deep |
| J445/16 | Punch, Prick 5/16" | J4711L | Socket, 1/4" DR 11/32" 6 PT Deep |
| J501/4 | Punch, Starting 3/32" | J4712L | Socket, 1/4" DR 3/8" 6 PT Deep |
| J505/16 | Punch, Starting 1/8" | J4714L | Socket, 1/4" DR 7/16" 6 PT Deep |
| J503/8 | Punch, Starting 3/16" | J4716L | Socket, 1/4" DR 1/2" 6 PT Deep |
| J507/16 | Punch, Starting 7/32" | J4718L | Socket, 1/4" DR 9/16" 6 PT Deep |
| J501/2 | Punch, Starting 1/4" | J4708S | Socket, 1/4" DR 1/4" 8 PT |
| J5247 | Ratchet Adapter 3/8" DR 2-1/16" | J4710S | Socket, 1/4" DR 5/16" 8 PT |
| J5447 | Ratchet Adapter 1/2" DR 2-21/32" | J4712S | Socket, 1/4" DR 3/8" 8 PT |
| J4749 | Ratchet, 1/4" DR | J5208S | Socket, 3/8" DR 1/4" 8 PT |
| J5249 | Ratchet, 3/8" DR | J5210S | Socket, 3/8" DR 5/16" 8 PT |
| J5449 | Ratchet, 1/2" DR | J5212S | Socket, 3/8" DR 3/8" 8 PT |
| J5450 | Ratchet, 1/2" DR (Long Handle) | J5216S | Socket, 3/8" DR 1/2" 8 PT |
| J5649 | Ratchet, 3/4" DR | J5214S | Socket, 3/8" DR 7/16" 8 PT |
| J5257F | Ratchet, 3/8" DR Flex-Head 2-1/16" | J5208 | Socket, 3/8" DR 1/4" 12 PT |
| J5457F | Ratchet, 1/2" DR Flex-Head 17-3/32" | J5210 | Socket, 3/8" DR 5/16" 12 PT |
| J2375 | Retrieval Tool, Pocket Magnetic | J5212 | Socket, 3/8" DR 3/8" 12 PT |
| 28-240 | Scraper, Flexible Nylon 1-1/4" | J5214 | Socket, 3/8" DR 7/16" 12 PT |
| 28-540 | Scraper, Flexible 1-1/4" Wood Handle | J5216 | Socket, 3/8" DR 1/2" 12 PT |
| J2336 | Scapers, Gasket and Carbon | J5218 | Socket, 3/8" DR 9/16" 12 PT |
| J9884 | Screw Starter, Phillips® Tip | J5220 | Socket, 3/8" DR 5/8" 12 PT |
| J9853 | Screw Starter, Standard Tip | J5222 | Socket, 3/8" DR 11/16" 12 PT |
| J88203 | Screwdriver, Slotted Cabinet, Round 1/8" x 3" | J5224 | Socket, 3/8" DR 3/4" 12 PT |
| J88204 | Screwdriver, Slotted Cabinet, Round 1/8" x 4" | J5226 | Socket, 3/8" DR 13/16" 12 PT |
| J88208 | Screwdriver, Slotted Cabinet, Round 1/8" x 8" | J5228 | Socket, 3/8" DR 7/8" 12 PT |
| J88214 | Screwdriver, Slotted Cabinet, Round 3/16" x 4" | J5230 | Socket, 3/8" DR 15/16" 12 PT |
| J88218 | Screwdriver, Slotted Cabinet, Round 3/16" x 8" | J5232 | Socket, 3/8" DR 1" 12 PT |
| J88393 | Screwdriver, Phillips® #0 | J5008 | Socket, 3/8" DR 1/4" 12 PT Deep |
| J88313 | Screwdriver, Phillips® #1 | J5010 | Socket, 3/8" DR 5/16" 12 PT Deep |
| J88318 | Screwdriver, Phillips® #1 | J5012 | Socket, 3/8" DR 3/8" 12 PT Deep |
| J88322 | Screwdriver, Phillips® #2 | J5014 | Socket, 3/8" DR 7/16" 12 PT Deep |
| J88324 | Screwdriver, Phillips® #2 | J5016 | Socket, 3/8" DR 1/2" 12 PT Deep |
| J88328 | Screwdriver, Phillips® #2 | J5018 | Socket, 3/8" DR 9/16" 12 PT Deep |
| J88336 | Screwdriver, Phillips® #3 | J5020 | Socket, 3/8" DR 5/8" 12 PT Deep |
| J88348 | Screwdriver, Phillips® #4 | J5022 | Socket, 3/8" DR 11/16" 12 PT Deep |
| J88102 | Screwdriver, Slotted Keystone, Square 1/4" x 2" | J5024 | Socket, 3/8" DR 3/4" 12 PT Deep |
| J88104 | Screwdriver, Slotted Keystone, Square 1/4" x 4" | J5026 | Socket, 3/8" DR 13/16" 12 PT Deep |
| J88106 | Screwdriver, Slotted Keystone, Square 1/4" x 6" | J5028 | Socket, 3/8" DR 7/8" 12 PT Deep |
| J88108 | Screwdriver, Slotted Keystone, Square 1/4" x 8" | J5030 | Socket, 3/8" DR 15/16" 12 PT Deep |
| J88112 | Screwdriver, Slotted Keystone, Square 1/4" x 12" | J5032 | Socket, 3/8" DR 1" 12 PT Deep |
| J88002 | Screwdriver, Slotted Keystone, Round 1/4" x 1-1/2" | J5412S | Socket, 1/2" DR 3/8" 8 PT |
| J303S | Snips, Aviation Straight | J5414S | Socket, 1/2" DR 7/16" 8 PT |
| J4706 | Socket, 1/4" DR 3/16" 6 PT | J5416S | Socket, 1/2" DR 1/2" 8 PT |
| J4707 | Socket, 1/4" DR 7/32" 6 PT | J5418S | Socket, 1/2" DR 9/16" 8 PT |
| J4708 | Socket, 1/4" DR 1/4" 6 PT | J5420S | Socket, 1/2" DR 5/8" 8 PT |
| J4709 | Socket, 1/4" DR 9/32" 6 PT | J5422S | Socket, 1/2" DR 11/16" 8 PT |
| J4710 | Socket, 1/4" DR 5/16" 6 PT | J5424S | Socket, 1/2" DR 3/4" 8 PT |
| J4711 | Socket, 1/4" DR 11/32" 6 PT | J5426S | Socket, 1/2" DR 13/16" 8 PT |
| J4712 | Socket, 1/4" DR 3/8" 6 PT | J5428S | Socket, 1/2" DR 7/8" 8 PT |
| J4714 | Socket, 1/4" DR 7/16" 6 PT | J5432S | Socket, 1/2" DR 1" 8 PT |
| J4716 | Socket, 1/4" DR 1/2" 6 PT | J5412 | Socket, 1/2" DR 3/8" 12 PT |
| J4718 | Socket, 1/4" DR 9/16" 6 PT | J5414 | Socket, 1/2" DR 7/16" 12 PT |





| Contents | Description |
|----------|------------------------------------|
| J5416 | Socket, 1/2" DR 1/2" 12 PT |
| J5418 | Socket, 1/2" DR 9/16" 12 PT |
| J5419 | Socket, 1/2" DR 19/32" 12 PT |
| J5420 | Socket, 1/2" DR 5/8" 12 PT |
| J5422 | Socket, 1/2" DR 11/16" 12 PT |
| J5424 | Socket, 1/2" DR 3/4" 12 PT |
| J5425 | Socket, 1/2" DR 25/32" 12 PT |
| J5426 | Socket, 1/2" DR 13/16" 12 PT |
| J5429 | Socket, 1/2" DR 29/32" 12 PT |
| J5428 | Socket, 1/2" DR 7/8" 12 PT |
| J5430 | Socket, 1/2" DR 15/16" 12 PT |
| J5432 | Socket, 1/2" DR 1" 12 PT |
| J5434 | Socket, 1/2" DR 1-1/16" 12 PT |
| J5436 | Socket, 1/2" DR 1-1/8" 12 PT |
| J5438 | Socket, 1/2" DR 1-3/16" 12 PT |
| J5440 | Socket, 1/2" DR 1-1/4" 12 PT |
| J5442 | Socket, 1/2" DR 1-5/16" 12 PT |
| J5444 | Socket, 1/2" DR 1-3/8" 12 PT |
| J5446 | Socket, 1/2" DR 1-7/16" 12 PT |
| J5448 | Socket, 1/2" DR 1-1/2" 12 PT |
| J5316 | Socket, 1/2" DR 1/2" 12 PT Deep |
| J5318 | Socket, 1/2" DR 9/16" 12 PT Deep |
| J5320 | Socket, 1/2" DR 5/8" 12 PT Deep |
| J5322 | Socket, 1/2" DR 11/16" 12 PT Deep |
| J5324 | Socket, 1/2" DR 3/4" 12 PT Deep |
| J5326 | Socket, 1/2" DR 13/16" 12 PT Deep |
| J5328 | Socket, 1/2" DR 7/8" 12 PT Deep |
| J5330 | Socket, 1/2" DR 15/16" 12 PT Deep |
| J5332 | Socket, 1/2" DR 1" 12 PT Deep |
| J5334 | Socket, 1/2" DR 1-1/16" 12 PT Deep |
| J5336 | Socket, 1/2" DR 1-1/8" 12 PT Deep |
| J5340 | Socket, 1/2" DR 1-1/4" 12 PT Deep |
| J5444A | Socket, 1/2" DR Drag Link 3/4" |
| J5446A | Socket, 1/2" DR Drag Link 15/16" |
| J5528 | Socket, 3/4" DR 7/8" 12 PT |
| J5530 | Socket, 3/4" DR 15/16" 12 PT |
| J5532 | Socket, 3/4" DR 1" 12 PT |
| J5534 | Socket, 3/4" DR 1-1/16" 12 PT |
| J5536 | Socket, 3/4" DR 1-1/8" 12 PT |
| J5538 | Socket, 3/4" DR 1-3/16" 12 PT |
| J5540 | Socket, 3/4" DR 1-1/4" 12 PT |
| J5542 | Socket, 3/4" DR 1-5/16" 12 PT |
| J5544 | Socket, 3/4" DR 1-3/8" 12 PT |
| J5546 | Socket, 3/4" DR 1-7/16" 12 PT |
| J5548 | Socket, 3/4" DR 1-1/2" 12 PT |
| J5550 | Socket, 3/4" DR 1-9/16" 12 PT |
| J5552 | Socket, 3/4" DR 1-5/8" 12 PT |
| J5554 | Socket, 3/4" DR 1-11/16" 12 PT |
| J5556 | Socket, 3/4" DR 1-3/4" 12 PT |
| J5558 | Socket, 3/4" DR 1-13/16" 12 PT |
| J5560 | Socket, 3/4" DR 1-7/8" 12 PT |
| J5568 | Socket, 3/4" DR 2-1/8" 12 PT |
| J5570 | Socket, 3/4" DR 2-3/16" 12 PT |
| J5572 | Socket, 3/4" DR 2-1/4" 12 PT |
| J5576 | Socket, 3/4" DR 2-3/8" 12 PT |
| J5564 | Socket, 3/4" DR 2" 12 PT |
| J4744 | Socket, Bit 1/4" DR Slotted 3/16" |
| J4737 | Socket, Bit 1/4" DR #1 Phillips® |

| Contents | Description |
|-----------|---|
| J4738 | Socket, Bit 1/4" DR #2 Phillips® |
| J4743 | Socket, Bit 1/4" DR Slotted 1/4" 1-3/16" |
| J4745 | Socket, Bit 1/4" DR Slotted 1/4" 1-13/64" |
| J5241 | Socket, Bit 3/8" DR #2 Phillips® |
| J5242 | Socket, Bit 3/8" DR #3 Phillips® |
| J5243 | Socket, Bit 3/8" DR #4 Phillips® |
| J5246 | Socket, Bit 3/8" DR Slotted |
| J47701/16 | Socket, Hex Bit 1/4" DR 1/16" |
| J47705/64 | Socket, Hex Bit 1/4" DR 5/64" |
| J47703/32 | Socket, Hex Bit 1/4" DR 3/32" |
| J47707/64 | Socket, Hex Bit 1/4" DR 7/64" |
| J47701/8 | Socket, Hex Bit 1/4" DR 1/8" |
| J47709/64 | Socket, Hex Bit 1/4" DR 9/64" |
| J47705/32 | Socket, Hex Bit 1/4" DR 5/32" |
| J47703/16 | Socket, Hex Bit 1/4" DR 3/16" |
| J47707/32 | Socket, Hex Bit 1/4" DR 7/32" |
| J47701/4 | Socket, Hex Bit 1/4" DR 1/4" |
| J47705/16 | Socket, Hex Bit 1/4" DR 5/16" |
| J49901/8 | Socket, Hex Bit 3/8" DR 1/8" |
| J49901/4 | Socket, Hex Bit 3/8" DR 1/4" |
| J49903/8 | Socket, Hex Bit 3/8" DR 3/8" |
| J54411/4 | Socket, Hex Bit 1/2" DR 1/4" |
| J54413/8 | Socket, Hex Bit 1/2" DR 3/8" |
| J54415/16 | Socket, Hex Bit 1/2" DR 5/16" |
| J54417/16 | Socket, Hex Bit 1/2" DR 7/16" |
| J54411/2 | Socket, Hex Bit 1/2" DR 1/2" |
| J54419/16 | Socket, Hex Bit 1/2" DR 9/16" |
| J54415/8 | Socket, Hex Bit 1/2" DR 5/8" |
| J49905/32 | Socket, Hex Bit 3/8" DR 5/32" |
| J49903/16 | Socket, Hex Bit 3/8" DR 3/16" |
| J49907/32 | Socket, Hex Bit 3/8" DR 7/32" |
| J49905/16 | Socket, Hex Bit 3/8" DR 5/16" |
| J4771TA | Socket, Universal 1/4" DR 1/4" 12 PT |
| J4773TA | Socket, Universal 1/4" DR 3/8" 12 PT |
| J4772TA | Socket, Universal 1/4" DR 5/16" 12 PT |
| J4774TA | Socket, Universal 1/4" DR 7/16" 12 PT |
| J5475A | Socket, Universal 1/2" DR 1/2" 12 PT |
| J5476A | Socket, Universal 1/2" DR 9/16" 12 PT |
| J5477A | Socket, Universal 1/2" DR 5/8" 12 PT |
| J5273A | Socket, Universal 3/8" DR 3/8" 12 PT |
| J5274A | Socket, Universal 3/8" DR 7/16" 12 PT |
| J5275A | Socket, Universal 3/8" DR 1/2" 12 PT |
| J5276A | Socket, Universal 3/8" DR 9/16" 12 PT |
| J5277A | Socket, Universal 3/8" DR 5/8" 12 PT |
| J5278A | Socket, Universal 3/8" DR 11/16" 12 PT |
| J5279A | Socket, Universal 3/8" DR 3/4" 12 PT |
| 33-212 | Tape Rule, Stanley® Powerlock® with Metal Case 1/2" x 12' |
| J706 | Wrench, Adjustable 6" |
| J708 | Wrench, Adjustable 8" |
| J710 | Wrench, Adjustable 10" |
| J712 | Wrench, Adjustable 12" |
| J715 | Wrench, Adjustable 15" |
| J3314 | Wrench, Angle 7/32" |
| J3315 | Wrench, Angle 15/64" |
| J3316 | Wrench, Angle 1/4" |
| J3318 | Wrench, Angle 9/32" |
| J3322 | Wrench, Angle 11/32" |

(CONTINUED ON NEXT PAGE)

453 PC INTERMEDIATE TOOL SET (CONTINUED)

Product #: **J99720**



| Contents | Description | Contents | Description |
|----------|---|----------|--|
| J3320 | Wrench, Angle 5/16" | J4922CF | Wrench, Crowfoot 3/8" DR 11/16" Open End |
| J3324 | Wrench, Angle 3/8" | J4924CF | Wrench, Crowfoot 3/8" DR 3/4" Open End |
| J3328 | Wrench, Angle 7/16" | J4926CF | Wrench, Crowfoot 3/8" DR 13/16" Open End |
| J3332 | Wrench, Angle 1/2" | J4928CF | Wrench, Crowfoot 3/8" DR 7/8" Open End |
| J1170 | Wrench, Box 5/16" x 3/8" 12 PT | J3751 | Wrench, Flare Nut Combination 3/8" 6 PT |
| J1171 | Wrench, Box 7/16" x 1/2" 12 PT | J3752 | Wrench, Flare Nut Combination 7/16" 6 PT |
| J1172 | Wrench, Box 9/16" x 5/8" 12 PT | J3753 | Wrench, Flare Nut Combination 1/2" 6 PT |
| J1173 | Wrench, Box 11/16" x 3/4" 12 PT | J3754 | Wrench, Flare Nut Combination 9/16" 6 PT |
| J1174 | Wrench, Box 13/16" x 7/8" 12 PT | J3755 | Wrench, Flare Nut Combination 5/8" 6 PT |
| J1175 | Wrench, Box 15/16" x 1" 12 PT | J3756 | Wrench, Flare Nut Combination 11/16" 6 PT |
| J1176 | Wrench, Box 1-1/16" x 1-1/8" 12 PT | J3757 | Wrench, Flare Nut Combination 3/4" 6 PT |
| J1120 | Wrench, Box 5/16" x 3/8" 12 PT Short | J3812 | Wrench, Flare Nut Ratcheting 3/8" |
| J1122 | Wrench, Box 3/8" x 7/16" 12 PT Short | J3814 | Wrench, Flare Nut Ratcheting 7/16" |
| J1126 | Wrench, Box 1/2" x 9/16" 12 PT Short | J3816 | Wrench, Flare Nut Ratcheting 1/2" |
| J1131 | Wrench, Box 5/8" x 3/4" 12 PT Short | J3818 | Wrench, Flare Nut Ratcheting 9/16" |
| J801 | Wrench, Chain | J3820 | Wrench, Flare Nut Ratcheting 5/8" |
| J1210A | Wrench, Combination 5/16" 12 PT | J3822 | Wrench, Flare Nut Ratcheting 11/16" |
| J1212ASD | Wrench, Combination 3/8" 12 PT | J3824 | Wrench, Flare Nut Ratcheting 3/4" |
| J1214ASD | Wrench, Combination 7/16" 12 PT | J1725 | Wrench, Obstruction 7/16" x 1/2" |
| J1216ASD | Wrench, Combination 1/2" 12 PT | J1730 | Wrench, Obstruction 9/16" x 5/8" |
| J1218ASD | Wrench, Combination 9/16" 12 PT | J1731 | Wrench, Obstruction 5/8" x 3/4" |
| J1220ASD | Wrench, Combination 5/8" 12 PT | J3018 | Wrench, Open End 1/4" x 5/16" |
| J1222ASD | Wrench, Combination 11/16" 12 PT | J3020 | Wrench, Open End 3/8" x 5/16" |
| J1224ASD | Wrench, Combination 3/4" 12 PT | J3025 | Wrench, Open End 7/16" x 1/2" |
| J1226ASD | Wrench, Combination 13/16" 12 PT | J3026 | Wrench, Open End 1/2" x 9/16" |
| J1228ASD | Wrench, Combination 7/8" 12 PT | J3030 | Wrench, Open End 9/16" x 5/8" |
| J1230ASD | Wrench, Combination 15/16" 12 PT | J3031 | Wrench, Open End 5/8" x 3/4" |
| J1232ASD | Wrench, Combination 1" 12 PT | J3035 | Wrench, Open End 11/16" x 3/4" |
| J1234ASD | Wrench, Combination 1-1/16" 12 PT | J3040 | Wrench, Open End 13/16" x 7/8" |
| J1236ASD | Wrench, Combination 1-1/8" 12 PT | J3045 | Wrench, Open End 15/16" x 1" |
| J1240ASD | Wrench, Combination 1-1/4" 12 PT | J3050 | Wrench, Open End 1-1/16" x 1-1/8" |
| J1242 | Wrench, Combination 1-5/16" 12 PT | J810HD | Wrench, Pipe Heavy-Duty 10" |
| J1244 | Wrench, Combination 1-3/8" 12 PT | J814HD | Wrench, Pipe Heavy-Duty 14" |
| J1246 | Wrench, Combination 1-7/16" 12 PT | J818HD | Wrench, Pipe Heavy-Duty 18" |
| J1248 | Wrench, Combination 1-1/2" 12 PT | J1191T-A | Wrench, Ratcheting Box 1/4" x 5/16" 12 PT |
| J1204EF | Wrench, Combination 1/8" 6 PT Short | J1192T-A | Wrench, Ratcheting Box 3/8" x 7/16" 12 PT |
| J1205EF | Wrench, Combination 5/32" 6 PT Short | J1193T-A | Wrench, Ratcheting Box 1/2" x 9/16" 12 PT |
| J1206EF | Wrench, Combination 3/16" 6 PT Short | J1194-A | Wrench, Ratcheting Box 5/8" x 11/16" 12 PT |
| J1208EF | Wrench, Combination 1/4" 6 PT Short | J1195-A | Wrench, Ratcheting Box 3/4" x 7/8" 12 PT |
| J1209EF | Wrench, Combination 9/32" 6 PT Short | J1270-12 | Wrench, Swivel Combination 3/8" 12 PT |
| J1210EF | Wrench, Combination 5/16" 6 PT Short | J1270-14 | Wrench, Swivel Combination 7/16" 12 PT |
| J1211EF | Wrench, Combination 11/32" 6 PT Short | J1270-16 | Wrench, Swivel Combination 1/2" 12 PT |
| J1212EF | Wrench, Combination 3/8" 6 PT Short | J1270-18 | Wrench, Swivel Combination 9/16" 12 PT |
| J4912CF | Wrench, Crowfoot 3/8" DR 3/8" Open End | J1270-20 | Wrench, Swivel Combination 5/8" 12 PT |
| J4914CF | Wrench, Crowfoot 3/8" DR 7/16" Open End | J1270-22 | Wrench, Swivel Combination 11/16" 12 PT |
| J4916CF | Wrench, Crowfoot 3/8" DR 1/2" Open End | J1270-24 | Wrench, Swivel Combination 3/4" 12 PT |
| J4918CF | Wrench, Crowfoot 3/8" DR 9/16" Open End | J6014C | Wrench, Torque 1/2" DR 50-250 ft-lbs |
| J4920CF | Wrench, Crowfoot 3/8" DR 5/8" Open End | | |



453 PC INTERMEDIATE SET WITH ROLLER CABINET J442742-8RD AND TOP CHEST J442719-12RD-D

Product #: J99721

- › 453 Pieces.
- › 1/4", 3/8", 1/2", 3/4" Drive Tools.
- › Designed for fastener sizes 3/16" - 2-3/8".
- › Contains: 211 Sockets and Accessories, 105 Wrenches, 30 Pliers, 32 Screwdrivers, 34 Striking and Struck Tools, 41 Miscellaneous Tools.
- › Weight: 623.0 lbs.



Representative Image; Contents May Differ

453 PC MASTER SET WITH ROLLER CABINET J453441-8RD AND TOP CHEST J453427-6RD

Product #: J99722

- › 453 Pieces.
- › 1/4", 3/8", 1/2", 3/4" Drive Tools.
- › Designed for fastener sizes 1/8" - 2-3/8".
- › Contains: 211 Sockets and Accessories, 105 Wrenches, 34 Striking and Struck Tools, 30 Pliers, 32 Screwdrivers, 41 Miscellaneous Tools.
- › Weight: 821.0 lbs.



Representative Image; Contents May Differ

233 PC INTERMEDIATE MAINTENANCE TOOL SET

Product #: J99820



- › 233 Pieces.
- › 1/4", 3/8" Drive Tools.
- › Designed for fastener sizes 1/16" - 1".
- › Tools only.
- › Contains: 109 Sockets and Accessories, 40 Wrenches, 29 Striking and Struck Tools, 11 Pliers, 30 Screwdrivers, 14 Miscellaneous Tools.
- › Sub-sets contained: J99810, J99825.
- › Weight: 104.0 lbs.



Representative Image; Contents May Differ





| Contents | Description |
|-----------|--|
| J4770A | Adapter, Universal Joint 1/4" DR |
| J5270A | Adapter, Universal Joint 3/8" DR |
| J86A3/16 | Chisel, Cold 1/4" |
| J86A1/4 | Chisel, Cold 5/16" |
| J86A5/16 | Chisel, Cold 3/8" |
| J86A7/16 | Chisel, Cold 1/2" |
| J86A1/2 | Chisel, Cold 5/8" |
| J86A5/8 | Chisel, Cold 3/4" |
| J86A3/4X8 | Chisel, Cold 7/8" |
| J86A7/8X8 | Chisel, Cold 1" |
| J86A1X8 | Chisel, Cold 1-3/16" |
| J4769 | Driver, 1/4" DR |
| J4759 | Extension, 1/4" DR 2" |
| J4760 | Extension, 1/4" DR 3" |
| J4761 | Extension, 1/4" DR 6" |
| J5260 | Extension, 3/8" DR 3" |
| J5260-06 | Extension, 3/8" DR 6" |
| J5262 | Extension, 3/8" DR 12" |
| J4765 | Extension, Flex 1/4" DR 6-1/4" |
| J5268 | Extension, Flex 3/8" DR 8" |
| J5260W | Extension, Wobble 3/8" DR 3" |
| J1308PD | Hammer, Ball Pein 8 oz. |
| J1316PD | Hammer, Ball Pein 16 oz. |
| J4766 | Handle, Hinge 1/4" DR 5-3/4" |
| J5265 | Handle, Hinge 3/8" DR 8-1/2" |
| J4785 | Handle, Sliding T 1/4" DR |
| J5285 | Handle, Sliding T 3/8" DR |
| J5280G | Handle, Speed 3/8" DR |
| J4980 | Hex Key, 13 PC Standard Set |
| J2108 | Holder, Punch and Chisel |
| J95218 | Knife, Folding Blade |
| J18545B | Knife, Lockback 5" |
| J9206 | Nut Driver, 3/16" |
| J9207 | Nut Driver, 7/32" |
| J9208 | Nut Driver, 1/4" |
| J9209 | Nut Driver, 9/32" |
| J9210 | Nut Driver, 5/16" |
| J9211 | Nut Driver, 11/32" |
| J9212 | Nut Driver, 3/8" |
| J9214 | Nut Driver 7/16" |
| J9216 | Nut Driver, 1/2" |
| J9218 | Nut Driver, 9/16" |
| J9220 | Nut Driver, 5/8" |
| J206G | Pliers, Diagonal Cutting with Grip 6-1/16" |
| J209G | Pliers, Diagonal Cutting with Grip 7-5/16" |
| J227G | Pliers, Duckbill with Grip 7-25/32" |
| J272G | Pliers, End Cutting High Leverage 8-1/4" |
| J268G | Pliers, Lineman's with Grip 8-5/8" |
| J292NC | Pliers, Locking Curved 10" |
| J291NC | Pliers, Locking Straight 7" |
| J226G | Pliers, Needle-Nose with Cutter 6-5/8" |
| J276G | Pliers, Slip-Joint with Grip 6-9/16" |
| J278G | Pliers, Slip-Joint with Grip 8-1/16" |
| J298 | Pliers, Wire Strippers 8-1/4" |
| J413/8 | Punch, Center 3/8" |
| J411/2 | Punch, Center 1/2" |
| J965/16 | Punch, Drift 1/8" |
| J963/8 | Punch, Drift 3/16" |

| Contents | Description |
|--------------|--|
| J961/2 | Punch, Drift 1/4" |
| J471/4X3/32 | Punch, Pin 3/32" |
| J475/16X1/8 | Punch, Pin 1/8" |
| J475/16X5/32 | Punch, Pin 5/32" |
| J473/8X3/16 | Punch, Pin 3/16" |
| J477/16X7/32 | Punch, Pin 7/32" |
| J471/2X1/4 | Punch, Pin 1/4" |
| J445/16 | Punch, Prick 5/16" |
| J501/4 | Punch, Starting 3/32" |
| J505/16 | Punch, Starting 1/8" |
| J503/8 | Punch, Starting 3/16" |
| J507/16 | Punch, Starting 7/32" |
| J501/2 | Punch, Starting 1/4" |
| J4749 | Ratchet, 1/4" DR |
| J5249 | Ratchet, 3/8" DR |
| J5247 | Ratchet Adapter 3/8" DR 2-1/16" |
| J5257F | Ratchet, 3/8" DR Flex-Head 2-1/16" |
| J88203 | Screwdriver, Slotted Cabinet, Round 1/8" x 3" |
| J88208 | Screwdriver, Slotted Cabinet, Round 1/8" x 8" |
| J88204 | Screwdriver, Slotted Cabinet, Round 1/8" x 4" |
| J88214 | Screwdriver, Slotted Cabinet, Round 3/16" x 4" |
| J88218 | Screwdriver, Slotted Cabinet, Round 3/16" x 8" |
| J88393 | Screwdriver, Phillips® #0 |
| J88313 | Screwdriver, Phillips® #1 |
| J88318 | Screwdriver, Phillips® #1 |
| J88322 | Screwdriver, Phillips® #2 |
| J88324 | Screwdriver, Phillips® #2 |
| J88328 | Screwdriver, Phillips® #2 |
| J88336 | Screwdriver, Phillips® #3 |
| J88348 | Screwdriver, Phillips® #4 |
| J88102 | Screwdriver, Slotted Keystone, Square 1/4" x 2" |
| J88104 | Screwdriver, Slotted Keystone, Square 1/4" x 4" |
| J88106 | Screwdriver, Slotted Keystone, Square 1/4" x 6" |
| J88108 | Screwdriver, Slotted Keystone, Square 1/4" x 8" |
| J88112 | Screwdriver, Slotted Keystone, Square 1/4" x 12" |
| J88002 | Screwdriver, Slotted Keystone, Round 1/4" x 1-1/2" |
| J4706 | Socket, 1/4" DR 3/16" 6 PT |
| J4707 | Socket, 1/4" DR 7/32" 6 PT |
| J4708 | Socket, 1/4" DR 1/4" 6 PT |
| J4709 | Socket, 1/4" DR 9/32" 6 PT |
| J4710 | Socket, 1/4" DR 5/16" 6 PT |
| J4711 | Socket, 1/4" DR 11/32" 6 PT |
| J4712 | Socket, 1/4" DR 3/8" 6 PT |
| J4714 | Socket, 1/4" DR 7/16" 6 PT |
| J4716 | Socket, 1/4" DR 1/2" 6 PT |
| J4718 | Socket, 1/4" DR 9/16" 6 PT |
| J4706L | Socket, 1/4" DR 3/16" 6 PT Deep |
| J4707L | Socket, 1/4" DR 7/32" 6 PT Deep |
| J4708L | Socket, 1/4" DR 1/4" 6 PT Deep |
| J4709L | Socket, 1/4" DR 9/32" 6 PT Deep |
| J4710L | Socket, 1/4" DR 5/16" 6 PT Deep |
| J4711L | Socket, 1/4" DR 11/32" 6 PT Deep |
| J4712L | Socket, 1/4" DR 3/8" 6 PT Deep |
| J4714L | Socket, 1/4" DR 7/16" 6 PT Deep |
| J4716L | Socket, 1/4" DR 1/2" 6 PT Deep |
| J4718L | Socket, 1/4" DR 9/16" 6 PT Deep |
| J4708S | Socket, 1/4" DR 1/4" 8 PT |
| J4710S | Socket, 1/4" DR 5/16" 8 PT |

(CONTINUED ON NEXT PAGE)

233 PC INTERMEDIATE MAINTENANCE TOOL SET (CONTINUED)

Product #: **J99820**



| Contents | Description | Contents | Description |
|-----------|---|-----------|--|
| J4712S | Socket, 1/4" DR 3/8" 8 PT | J49901/4 | Socket, Hex Bit 3/8" DR 1/4" |
| J5208 | Socket, 3/8" DR 1/4" 12 PT | J49903/8 | Socket, Hex Bit 3/8" DR 3/8" |
| J5210 | Socket, 3/8" DR 5/16" 12 PT | J49905/32 | Socket, Hex Bit 3/8" DR 5/32" |
| J5212 | Socket, 3/8" DR 3/8" 12 PT | J49903/16 | Socket, Hex Bit 3/8" DR 3/16" |
| J5214 | Socket, 3/8" DR 7/16" 12 PT | J49907/32 | Socket, Hex Bit 3/8" DR 7/32" |
| J5216 | Socket, 3/8" DR 1/2" 12 PT | J49905/16 | Socket, Hex Bit 3/8" DR 5/16" |
| J5218 | Socket, 3/8" DR 9/16" 12 PT | J5273A | Socket, Universal 3/8" DR 3/8" 12 PT |
| J5220 | Socket, 3/8" DR 5/8" 12 PT | J5274A | Socket, Universal 3/8" DR 7/16" 12 PT |
| J5222 | Socket, 3/8" DR 11/16" 12 PT | J5275A | Socket, Universal 3/8" DR 1/2" 12 PT |
| J5224 | Socket, 3/8" DR 3/4" 12 PT | J5276A | Socket, Universal 3/8" DR 9/16" 12 PT |
| J5226 | Socket, 3/8" DR 13/16" 12 PT | J5277A | Socket, Universal 3/8" DR 5/8" 12 PT |
| J5228 | Socket, 3/8" DR 7/8" 12 PT | J5278A | Socket, Universal 3/8" DR 11/16" 12 PT |
| J5230 | Socket, 3/8" DR 15/16" 12 PT | J5279A | Socket, Universal 3/8" DR 3/4" 12 PT |
| J5232 | Socket, 3/8" DR 1" 12 PT | J706 | Wrench, Adjustable 6" |
| J5008 | Socket, 3/8" DR 1/4" 12 PT Deep | J708 | Wrench, Adjustable 8" |
| J5010 | Socket, 3/8" DR 5/16" 12 PT Deep | J710 | Wrench, Adjustable 10" |
| J5012 | Socket, 3/8" DR 3/8" 12 PT Deep | J1170 | Wrench, Box 5/16" x 3/8" 12 PT |
| J5014 | Socket, 3/8" DR 7/16" 12 PT Deep | J1171 | Wrench, Box 7/16" x 1/2" 12 PT |
| J5016 | Socket, 3/8" DR 1/2" 12 PT Deep | J1172 | Wrench, Box 9/16" x 5/8" 12 PT |
| J5018 | Socket, 3/8" DR 9/16" 12 PT Deep | J1173 | Wrench, Box 11/16" x 3/4" 12 PT |
| J5020 | Socket, 3/8" DR 5/8" 12 PT Deep | J1174 | Wrench, Box 13/16" x 7/8" 12 PT |
| J5022 | Socket, 3/8" DR 11/16" 12 PT Deep | J1175 | Wrench, Box 15/16" x 1" 12 PT |
| J5024 | Socket, 3/8" DR 3/4" 12 PT Deep | J1176 | Wrench, Box 1-1/16" x 1-1/8" 12 PT |
| J5026 | Socket, 3/8" DR 13/16" 12 PT Deep | J1120 | Wrench, Box 5/16" x 3/8" 12 PT Short |
| J5028 | Socket, 3/8" DR 7/8" 12 PT Deep | J1122 | Wrench, Box 3/8" x 7/16" 12 PT Short |
| J5030 | Socket, 3/8" DR 15/16" 12 PT Deep | J1126 | Wrench, Box 1/2" x 9/16" 12 PT Short |
| J5032 | Socket, 3/8" DR 1" 12 PT Deep | J1131 | Wrench, Box 5/8" x 3/4" 12 PT Short |
| J5208S | Socket, 3/8" DR 1/4" 8 PT | J808HD | Wrench, Pipe Heavy-Duty 8" |
| J5210S | Socket, 3/8" DR 5/16" 8 PT | J1210A | Wrench, Combination 5/16" 12 PT |
| J5212S | Socket, 3/8" DR 3/8" 8 PT | J1212ASD | Wrench, Combination 3/8" 12 PT |
| J5214S | Socket, 3/8" DR 7/16" 8 PT | J1214ASD | Wrench, Combination 7/16" 12 PT |
| J5216S | Socket, 3/8" DR 1/2" 8 PT | J1216ASD | Wrench, Combination 1/2" 12 PT |
| J4743 | Socket, Bit 1/4" DR Slotted 1/4" 1-3/16" | J1218ASD | Wrench, Combination 9/16" 12 PT |
| J4744 | Socket, Bit 1/4" DR Slotted 3/16" | J1220ASD | Wrench, Combination 5/8" 12 PT |
| J4737 | Socket, Bit 1/4" DR #1 Phillips® | J1222ASD | Wrench, Combination 11/16" 12 PT |
| J4738 | Socket, Bit 1/4" DR #2 Phillips® | J1224ASD | Wrench, Combination 3/4" 12 PT |
| J4745 | Socket, Bit 1/4" DR Slotted 1/4" 1-13/64" | J1226ASD | Wrench, Combination 13/16" 12 PT |
| J5241 | Socket, Bit 3/8" DR #2 Phillips® | J1230ASD | Wrench, Combination 15/16" 12 PT |
| J5242 | Socket, Bit 3/8" DR #3 Phillips® | J1228ASD | Wrench, Combination 7/8" 12 PT |
| J5243 | Socket, Bit 3/8" DR #4 Phillips® | J1232ASD | Wrench, Combination 1" 12 PT |
| J5246 | Socket, Bit 3/8" DR Slotted | J1234ASD | Wrench, Combination 1-1/16" 12 PT |
| J47701/16 | Socket, Hex Bit 1/4" DR 1/16" | J1236ASD | Wrench, Combination 1-1/8" 12 PT |
| J47705/64 | Socket, Hex Bit 1/4" DR 5/64" | J1240ASD | Wrench, Combination 1-1/4" 12 PT |
| J47703/32 | Socket, Hex Bit 1/4" DR 3/32" | J3018 | Wrench, Open End 1/4" x 5/16" |
| J47701/8 | Socket, Hex Bit 1/4" DR 1/8" | J3020 | Wrench, Open End 3/8" x 5/16" |
| J47705/32 | Socket, Hex Bit 1/4" DR 5/32" | J3025 | Wrench, Open End 7/16" x 1/2" |
| J47703/16 | Socket, Hex Bit 1/4" DR 3/16" | J3026 | Wrench, Open End 1/2" x 9/16" |
| J47707/64 | Socket, Hex Bit 1/4" DR 7/64" | J3030 | Wrench, Open End 9/16" x 5/8" |
| J47707/32 | Socket, Hex Bit 1/4" DR 7/32" | J3031 | Wrench, Open End 5/8" x 3/4" |
| J47701/4 | Socket, Hex Bit 1/4" DR 1/4" | J3035 | Wrench, Open End 11/16" x 3/4" |
| J47709/64 | Socket, Hex Bit 1/4" DR 9/64" | J3040 | Wrench, Open End 13/16" x 7/8" |
| J47705/16 | Socket, Hex Bit 1/4" DR 5/16" | J3045 | Wrench, Open End 15/16" x 1" |
| J49901/8 | Socket, Hex Bit 3/8" DR 1/8" | J3050 | Wrench, Open End 1-1/16" x 1-1/8" |



233 PC ADVANCED MAINTENANCE SET WITH J442719-8RD TOP CHEST

Product #: J99821



- › 233 Pieces.
- › 1/4", 3/8" Drive Tools.
- › Designed for fastener sizes 1/16" - 1".
- › Contains: 109 Sockets and Accessories, 40 Wrenches, 29 Striking and Struck Tools, 11 Pliers, 19 Screwdrivers, 25 Miscellaneous Tools.
- › Sub-sets contained: J99810, J99825.
- › Weight: 244.0 lbs.



Representative Image; Contents May Differ



179 PC INTERMEDIATE MAINTENANCE TOOL SET

Product #: J99900



- › 179 Pieces.
- › 1/4", 3/8" Drive Tools.
- › Designed for fastener sizes 1/14" - 1", 4 mm - 19 mm.
- › Tools Only.
- › Contains: 143 Sockets and Accessories, 34 Wrenches, 1 Striking and Struck Tool, 1 Pliers.
- › Weight: 46.0 lbs.

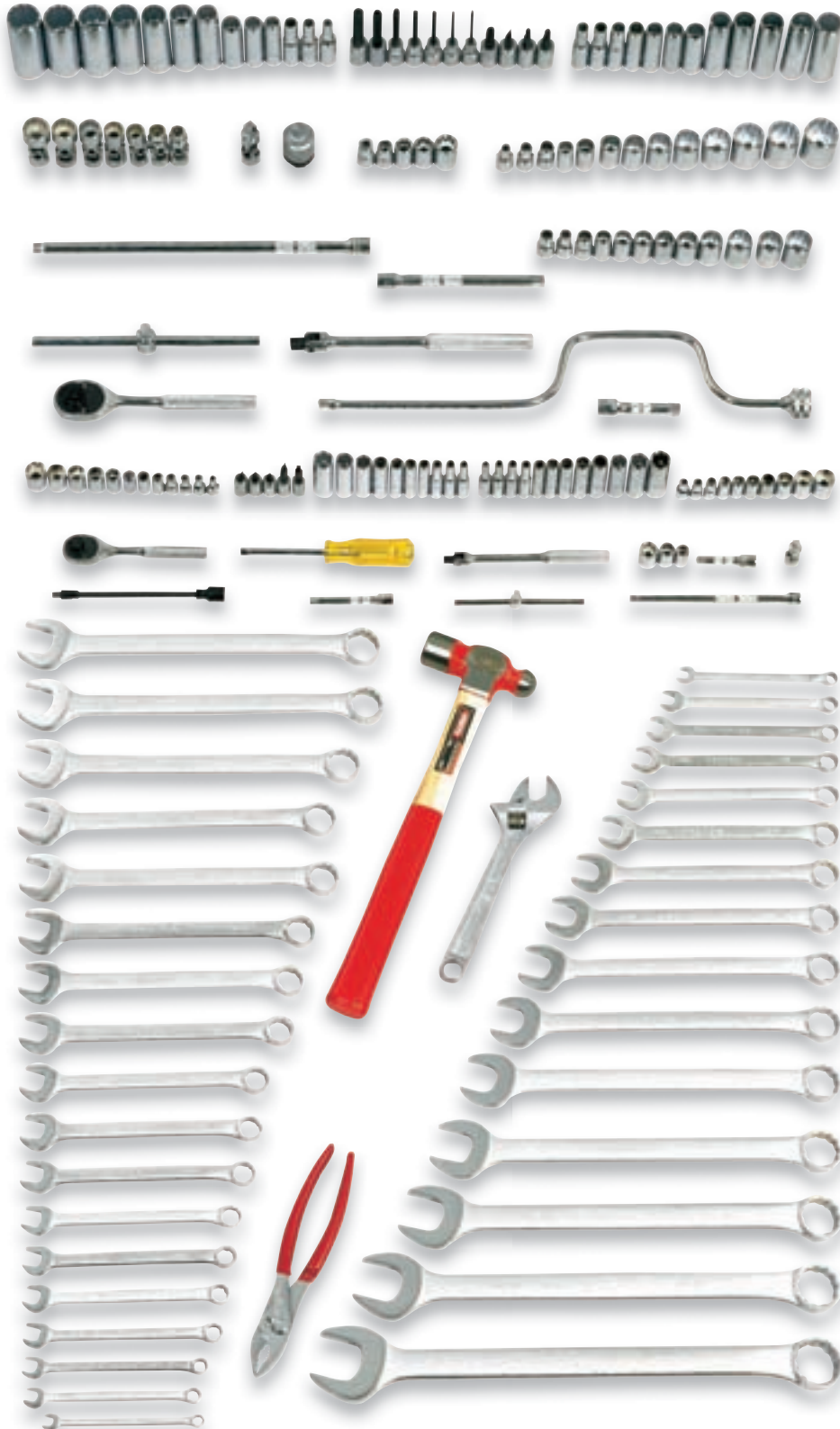

Representative Image; Contents May Differ





| Contents | Description |
|-----------------|--------------------------------------|
| J4770A | Adapter, Universal Joint 1/4" DR |
| J5270A | Adapter, Universal Joint 3/8" DR |
| J4769 | Driver, 1/4" DR |
| J4759 | Extension, 1/4" DR 2" |
| J4760 | Extension, 1/4" DR 3" |
| J4761 | Extension, 1/4" DR 6" |
| J5260 | Extension, 3/8" DR 3" |
| J5260-06 | Extension, 3/8" DR 6" |
| J5262 | Extension, 3/8" DR 12" |
| J4765 | Extension, Flex 1/4" DR 6-1/4" |
| J1316PD | Hammer, Ball Pein 16 oz. |
| J4766 | Handle, Hinge 1/4" DR 5-3/4" |
| J5265 | Handle, Hinge 3/8" DR 8-1/2" |
| J4785 | Handle, Sliding T 1/4" DR |
| J5285 | Handle, Sliding T 3/8" DR |
| J5280G | Handle, Speed 3/8 DR |
| J278G | Pliers, Slip-Joint with Grip 8-1/16" |
| J5247 | Ratchet Adapter 3/8" DR 2-1/16" |
| J4749 | Ratchet, 1/4" DR |
| J5249 | Ratchet, 3/8" DR |
| J4706 | Socket, 1/4" DR 3/16" 6 PT |
| J4707 | Socket, 1/4" DR 7/32" 6 PT |
| J4708 | Socket, 1/4" DR 1/4" 6 PT |
| J4709 | Socket, 1/4" DR 9/32" 6 PT |
| J4710 | Socket, 1/4" DR 5/16" 6 PT |
| J4712 | Socket, 1/4" DR 3/8" 6 PT |
| J4711 | Socket, 1/4" DR 11/32" 6 PT |
| J4714 | Socket, 1/4" DR 7/16" 6 PT |
| J4716 | Socket, 1/4" DR 1/2" 6 PT |
| J4718 | Socket, 1/4" DR 9/16" 6 PT |
| J4704M | Socket, 1/4" DR 4 mm 6 PT |
| J4705M | Socket, 1/4" DR 5 mm 6 PT |
| J47055M | Socket, 1/4" DR 5.5 mm 6 PT |
| J4706M | Socket, 1/4" DR 6 mm 6 PT |
| J4707M | Socket, 1/4" DR 7 mm 6 PT |
| J4708M | Socket, 1/4" DR 8 mm 6 PT |
| J4709M | Socket, 1/4" DR 9 mm 6 PT |
| J4710M | Socket, 1/4" DR 10 mm 6 PT |
| J4711M | Socket, 1/4" DR 11 mm 6 PT |
| J4712M | Socket, 1/4" DR 12 mm 6 PT |
| J4713M | Socket, 1/4" DR 13 mm 6 PT |
| J4714M | Socket, 1/4" DR 14 mm 6 PT |
| J4706L | Socket, 1/4" DR 3/16" 6 PT Deep |
| J4707L | Socket, 1/4" DR 7/32" 6 PT Deep |
| J4718L | Socket, 1/4" DR 9/16" 6 PT Deep |
| J4708L | Socket, 1/4" DR 1/4" 6 PT Deep |
| J4709L | Socket, 1/4" DR 9/32" 6 PT Deep |
| J4710L | Socket, 1/4" DR 5/16" 6 PT Deep |
| J4712L | Socket, 1/4" DR 3/8" 6 PT Deep |
| J4711L | Socket, 1/4" DR 11/32" 6 PT Deep |
| J4714L | Socket, 1/4" DR 7/16" 6 PT Deep |
| J4716L | Socket, 1/4" DR 1/2" 6 PT Deep |
| J4704LM | Socket, 1/4" DR 4 mm 6 PT Deep |
| J4705LM | Socket, 1/4" DR 5 mm 6 PT Deep |
| J47055LM | Socket, 1/4" DR 5.5 mm 6 PT Deep |
| J4706LM | Socket, 1/4" DR 6 mm 6 PT Deep |
| J4707LM | Socket, 1/4" DR 7 mm 6 PT Deep |
| J4708LM | Socket, 1/4" DR 8 mm 6 PT Deep |

| Contents | Description |
|-----------------|-----------------------------------|
| J4709LM | Socket, 1/4" DR 9 mm 6 PT Deep |
| J4710LM | Socket, 1/4" DR 10 mm 6 PT Deep |
| J4711LM | Socket, 1/4" DR 11 mm 6 PT Deep |
| J4712LM | Socket, 1/4" DR 12 mm 6 PT Deep |
| J4713LM | Socket, 1/4" DR 13 mm 6 PT Deep |
| J4714LM | Socket, 1/4" DR 14 mm 6 PT Deep |
| J4708S | Socket, 1/4" DR 1/4" 8 PT |
| J4710S | Socket, 1/4" DR 5/16" 8 PT |
| J4712S | Socket, 1/4" DR 3/8" 8 PT |
| J5208 | Socket, 3/8" DR 1/4" 12 PT |
| J5210 | Socket, 3/8" DR 5/16" 12 PT |
| J5212 | Socket, 3/8" DR 3/8" 12 PT |
| J5214 | Socket, 3/8" DR 7/16" 12 PT |
| J5216 | Socket, 3/8" DR 1/2" 12 PT |
| J5218 | Socket, 3/8" DR 9/16" 12 PT |
| J5220 | Socket, 3/8" DR 5/8" 12 PT |
| J5222 | Socket, 3/8" DR 11/16" 12 PT |
| J5224 | Socket, 3/8" DR 3/4" 12 PT |
| J5226 | Socket, 3/8" DR 13/16" 12 PT |
| J5228 | Socket, 3/8" DR 7/8" 12 PT |
| J5230 | Socket, 3/8" DR 15/16" 12 PT |
| J5232 | Socket, 3/8" DR 1" 12 PT |
| J5208M | Socket, 3/8" DR 8 mm 12 PT |
| J5209M | Socket, 3/8" DR 9 mm 12 PT |
| J5210M | Socket, 3/8" DR 10 mm 12 PT |
| J5211M | Socket, 3/8" DR 11 mm 12 PT |
| J5212M | Socket, 3/8" DR 12 mm 12 PT |
| J5213M | Socket, 3/8" DR 13 mm 12 PT |
| J5214M | Socket, 3/8" DR 14 mm 12 PT |
| J5215M | Socket, 3/8" DR 15 mm 12 PT |
| J5216M | Socket, 3/8" DR 16 mm 12 PT |
| J5217M | Socket, 3/8" DR 17 mm 12 PT |
| J5218M | Socket, 3/8" DR 18 mm 12 PT |
| J5219M | Socket, 3/8" DR 19 mm 12 PT |
| J5008 | Socket, 3/8" DR 1/4" 12 PT Deep |
| J5010 | Socket, 3/8" DR 5/16" 12 PT Deep |
| J5012 | Socket, 3/8" DR 3/8" 12 PT Deep |
| J5014 | Socket, 3/8" DR 7/16" 12 PT Deep |
| J5016 | Socket, 3/8" DR 1/2" 12 PT Deep |
| J5018 | Socket, 3/8" DR 9/16" 12 PT Deep |
| J5020 | Socket, 3/8" DR 5/8" 12 PT Deep |
| J5022 | Socket, 3/8" DR 11/16" 12 PT Deep |
| J5024 | Socket, 3/8" DR 3/4" 12 PT Deep |
| J5026 | Socket, 3/8" DR 13/16" 12 PT Deep |
| J5028 | Socket, 3/8" DR 7/8" 12 PT Deep |
| J5030 | Socket, 3/8" DR 15/16" 12 PT Deep |
| J5032 | Socket, 3/8" DR 1" 12 PT Deep |
| J5008M | Socket, 3/8" DR 8 mm 12 PT Deep |
| J5009M | Socket, 3/8" DR 9 mm 12 PT Deep |
| J5010M | Socket, 3/8" DR 10 mm 12 PT Deep |
| J5011M | Socket, 3/8" DR 11 mm 12 PT Deep |
| J5012M | Socket, 3/8" DR 12 mm 12 PT Deep |
| J5013M | Socket, 3/8" DR 13 mm 12 PT Deep |
| J5014M | Socket, 3/8" DR 14 mm 12 PT Deep |
| J5015M | Socket, 3/8" DR 15 mm 12 PT Deep |
| J5016M | Socket, 3/8" DR 16 mm 12 PT Deep |
| J5017M | Socket, 3/8" DR 17 mm 12 PT Deep |
| J5018M | Socket, 3/8" DR 18 mm 12 PT Deep |

(CONTINUED ON NEXT PAGE)

179 PC INTERMEDIATE MAINTENANCE TOOL SET (CONTINUED)

Product #: J99900



| Contents | Description | Contents | Description |
|-----------|---|-----------|-----------------------------------|
| J5019M | Socket, 3/8" DR 19 mm 12 PT Deep | J1214ASD | Wrench, Combination 7/16" 12 PT |
| J5208S | Socket, 3/8" DR 1/4" 8 PT | J1216ASD | Wrench, Combination 1/2" 12 PT |
| J5210S | Socket, 3/8" DR 5/16" 8 PT | J1218ASD | Wrench, Combination 9/16" 12 PT |
| J5212S | Socket, 3/8" DR 3/8" 8 PT | J1220ASD | Wrench, Combination 5/8" 12 PT |
| J5214S | Socket, 3/8" DR 7/16" 8 PT | J1222ASD | Wrench, Combination 11/16" 12 PT |
| J5216S | Socket, 3/8" DR 1/2" 8 PT | J1224ASD | Wrench, Combination 3/4" 12 PT |
| J4744 | Socket, Bit 1/4" DR Slotted 3/16" | J1226ASD | Wrench, Combination 13/16" 12 PT |
| J4737 | Socket, Bit 1/4" DR #1 Phillips® | J1228ASD | Wrench, Combination 7/8" 12 PT |
| J4738 | Socket, Bit 1/4" DR #2 Phillips® | J1230ASD | Wrench, Combination 15/16" 12 PT |
| J4745 | Socket, Bit 1/4" DR Slotted 1/4" 1-13/64" | J1232ASD | Wrench, Combination 1" 12 PT |
| J5241 | Socket, Bit 3/8" DR #2 Phillips® | J1234ASD | Wrench, Combination 1-1/16" 12 PT |
| J5242 | Socket, Bit 3/8" DR #3 Phillips® | J1236ASD | Wrench, Combination 1-1/8" 12 PT |
| J5243 | Socket, Bit 3/8" DR #4 Phillips® | J1240ASD | Wrench, Combination 1-1/4" 12 PT |
| J4743 | Socket, Bit 1/4" DR Slotted 1/4" 1-3/16" | J1209MA | Wrench, Combination 9 mm 12 PT |
| J5246 | Socket, Bit 3/8" DR Slotted | J1208MA | Wrench, Combination 8 mm 12 PT |
| J49901/8 | Socket, Hex Bit 3/8" DR 1/8" | J1207MA | Wrench, Combination 7 mm 12 PT |
| J49905/32 | Socket, Hex Bit 3/8" DR 5/32" | J1210MASD | Wrench, Combination 10 mm 12 PT |
| J49903/16 | Socket, Hex Bit 3/8" DR 3/16" | J1211MASD | Wrench, Combination 11 mm 12 PT |
| J49907/32 | Socket, Hex Bit 3/8" DR 7/32" | J1212MASD | Wrench, Combination 12 mm 12 PT |
| J49901/4 | Socket, Hex Bit 3/8" DR 1/4" | J1213MASD | Wrench, Combination 13 mm 12 PT |
| J49905/16 | Socket, Hex Bit 3/8" DR 5/16" | J1214MASD | Wrench, Combination 14 mm 12 PT |
| J49903/8 | Socket, Hex Bit 3/8" DR 3/8" | J1215MASD | Wrench, Combination 15 mm 12 PT |
| J5273A | Socket, Universal 3/8" DR 3/8" 12 PT | J1216MASD | Wrench, Combination 16 mm 12 PT |
| J5274A | Socket, Universal 3/8" DR 7/16" 12 PT | J1217MASD | Wrench, Combination 17 mm 12 PT |
| J5275A | Socket, Universal 3/8" DR 1/2" 12 PT | J1218MASD | Wrench, Combination 18 mm 12 PT |
| J5276A | Socket, Universal 3/8" DR 9/16" 12 PT | J1219MASD | Wrench, Combination 19 mm 12 PT |
| J5277A | Socket, Universal 3/8" DR 5/8" 12 PT | J1220MASD | Wrench, Combination 20 mm 12 PT |
| J5278A | Socket, Universal 3/8" DR 11/16" 12 PT | J1221MASD | Wrench, Combination 21 mm 12 PT |
| J5279A | Socket, Universal 3/8" DR 3/4" 12 PT | J1222MASD | Wrench, Combination 22 mm 12 PT |
| J708 | Wrench, Adjustable 8" | J1223MASD | Wrench, Combination 23 mm 12 PT |
| J1210A | Wrench, Combination 5/16" 12 PT | J1224MASD | Wrench, Combination 24 mm 12 PT |
| J1212ASD | Wrench, Combination 3/8" 12 PT | | |



179 PC INTERMEDIATE MAINTENANCE SET WITH ROLLER CABINET J442735-7RD

Product #: J99901

- › 179 Pieces.
- › 1/4", 3/8" Drive Tools.
- › Designed for fastener sizes 1/14" - 1", 4 mm - 19 mm.
- › Contains: 143 Sockets and Accessories, 34 Wrenches, 1 Striking and Struck Tool, 1 Plier.
- › Weight: 221.0 lbs.

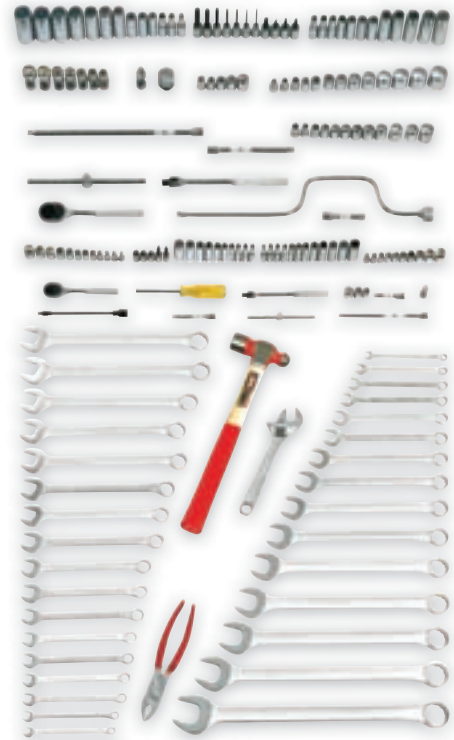

Representative Image; Contents May Differ

179 PC INTERMEDIATE MAINTENANCE SET WITH ROLLER CABINET J442742-7RD

Product #: J99902

- › 179 Pieces.
- › 1/4", 3/8" Drive Tools.
- › Designed for fastener sizes 3/16" - 1-1/4", 4 mm - 19 mm.
- › Contains: 143 Sockets and Accessories, 34 Wrenches, 1 Striking and Struck Tool, 1 Plier.
- › Weight: 226.0 lbs.



Representative Image; Contents May Differ

165 PC INTERMEDIATE MAINTENANCE TOOL SET

Product #: J99490



- › 165 Pieces.
- › 3/8", 1/2" Drive Tools.
- › Designed for fasteners sizes 1/8" - 1-1/4".
- › Tools only.
- › Contains: 76 Sockets and Accessories, 27 Wrenches, 15 Striking and Struck Tools, 13 Pliers, 12 Scwdrivers, 22 Miscellaneous Tools.
- › Sub-sets contained J99480, J99485.
- › Weight: 78.0 lbs.



Representative Image; Contents May Differ

| Contents | Description | Contents | Description |
|----------|----------------------------------|----------|--|
| J5270A | Adapter, Universal Joint 3/8" DR | J5260-06 | Extension, 3/8" DR 6" |
| J5470A | Adapter, Universal Joint 1/2" DR | 15-265 | Hacksaw, 3-7/8" |
| J2126 | Bar, 12" Long 1/2" Tip | J1316PD | Hammer, Ball Pein 16 oz. |
| J2120 | Bar, Pry Aligning 18" | 57-532 | Hammer, Compo-Cast® 21 oz. |
| J86A1/4 | Chisel, Cold 5/16" | J5265 | Handle, Hinge 3/8" DR 8-1/2" |
| J86A3/8 | Chisel, Cold 7/16" | J5480G | Handle, Speed 1/2" DR |
| J86A7/16 | Chisel, Cold 1/2" | J5280G | Handle, Speed 3/8" DR |
| J725/16 | Chisel, Cape 13/64" | J4980 | Hex Key, 13 PC Standard Set |
| J765/16 | Chisel, Diamond PT 3/16" | J5467 | Handle, Hinge 1/2" DR 15-3/4" |
| J9521 | Extractor, Screw 1/8" | J2108 | Holder, Punch and Chisel |
| J9522 | Extractor, Screw 3/16" | J206G | Pliers, Diagonal Cutting with Grip 6-1/16" |
| J9523 | Extractor, Screw 15/64" | J209G | Pliers, Diagonal Cutting with Grip 7-5/16" |
| J9524 | Extractor, Screw 5/16" | J272G | Pliers, End Cutting High Leverage 8-1/4" |
| J9525 | Extractor, Screw 3/8" | J268G | Pliers, Lineman's with Grip 8-5/8" |
| J5460 | Extension, 1/2" DR 2-1/2" | J292NC | Pliers, Locking Curved 10" |
| J5461 | Extension, 1/2" DR 5" | J291NC | Pliers, Locking Straight 7" |
| J5463 | Extension, 1/2" DR 10" | J226G | Pliers, Needle-Nose with Cutter 6-5/8" |
| J5262 | Extension, 3/8" DR 12" | J278G | Pliers, Slip-Joint with Grip 8-1/16" |
| J5260 | Extension, 3/8" DR 3" | | |





| Contents | Description |
|-------------|---|
| J260SG | Pliers, Tongue and Groove 10-3/16" with Grip |
| J298 | Pliers, Wire Strippers 8-1/4" |
| J413/8 | Punch, Center 3/8" |
| J471/4X3/32 | Punch, Pin 3/32" |
| J475/16X1/8 | Punch, Pin 1/8" |
| J473/8X3/16 | Punch, Pin 3/16" |
| J503/16 | Punch, Starting 1/16" |
| J505/16 | Punch, Starting 1/8" |
| J503/8 | Punch, Starting 3/16" |
| J5449 | Ratchet, 1/2" DR |
| J5249 | Ratchet, 3/8" DR |
| J2336 | Scapers, Gasket and Carbon |
| J88393 | Screwdriver, Phillips® #0 |
| J88313 | Screwdriver, Phillips® #1 |
| J88322 | Screwdriver, Phillips® #2 |
| J88324 | Screwdriver, Phillips® #2 |
| J88336 | Screwdriver, Phillips® #3 |
| J88348 | Screwdriver, Phillips® #4 |
| J88102 | Screwdriver, Slotted Keystone, Square 1/4" x 2" |
| J88104 | Screwdriver, Slotted Keystone, Square 1/4" x 4" |
| J88106 | Screwdriver, Slotted Keystone, Square 1/4" x 6" |
| J88108 | Screwdriver, Slotted Keystone, Square 1/4" x 8" |
| J88112 | Screwdriver, Slotted Keystone, Square 1/4" x 12" |
| J88002 | Screwdriver, Slotted Keystone, Round 1/4" x 1-1/2" |
| J380 | Pliers, 6 PC Retaining Ring Set with Replacement Tips |
| J303S | Snips, Aviation Straight |
| J5212 | Socket, 3/8" DR 3/8" 12 PT |
| J5214 | Socket, 3/8" DR 7/16" 12 PT |
| J5216 | Socket, 3/8" DR 1/2" 12 PT |
| J5218 | Socket, 3/8" DR 9/16" 12 PT |
| J5220 | Socket, 3/8" DR 5/8" 12 PT |
| J5222 | Socket, 3/8" DR 11/16" 12 PT |
| J5224 | Socket, 3/8" DR 3/4" 12 PT |
| J5226 | Socket, 3/8" DR 13/16" 12 PT |
| J5228 | Socket, 3/8" DR 7/8" 12 PT |
| J5012 | Socket, 3/8" DR 3/8" 12 PT Deep |
| J5014 | Socket, 3/8" DR 7/16" 12 PT Deep |
| J5016 | Socket, 3/8" DR 1/2" 12 PT Deep |
| J5018 | Socket, 3/8" DR 9/16" 12 PT Deep |
| J5020 | Socket, 3/8" DR 5/8" 12 PT Deep |
| J5022 | Socket, 3/8" DR 11/16" 12 PT Deep |
| J5024 | Socket, 3/8" DR 3/4" 12 PT Deep |
| J5026 | Socket, 3/8" DR 13/16" 12 PT Deep |
| J5028 | Socket, 3/8" DR 7/8" 12 PT Deep |
| J5210S | Socket, 3/8" DR 5/16" 8 PT |
| J5212S | Socket, 3/8" DR 3/8" 8 PT |
| J5208S | Socket, 3/8" DR 1/4" 8 PT |
| J5412 | Socket, 1/2" DR 3/8" 12 PT |
| J5414 | Socket, 1/2" DR 7/16" 12 PT |
| J5416 | Socket, 1/2" DR 1/2" 12 PT |
| J5418 | Socket, 1/2" DR 9/16" 12 PT |
| J5420 | Socket, 1/2" DR 5/8" 12 PT |
| J5422 | Socket, 1/2" DR 11/16" 12 PT |
| J5424 | Socket, 1/2" DR 3/4" 12 PT |
| J5426 | Socket, 1/2" DR 13/16" 12 PT |
| J5428 | Socket, 1/2" DR 7/8" 12 PT |
| J5430 | Socket, 1/2" DR 15/16" 12 PT |

| Contents | Description |
|-----------|---------------------------------------|
| J5432 | Socket, 1/2" DR 1" 12 PT |
| J5434 | Socket, 1/2" DR 1-1/16" 12 PT |
| J5436 | Socket, 1/2" DR 1-1/8" 12 PT |
| J5440 | Socket, 1/2" DR 1-1/4" 12 PT |
| J5316 | Socket, 1/2" DR 1/2" 12 PT Deep |
| J5318 | Socket, 1/2" DR 9/16" 12 PT Deep |
| J5320 | Socket, 1/2" DR 5/8" 12 PT Deep |
| J5322 | Socket, 1/2" DR 11/16" 12 PT Deep |
| J5324 | Socket, 1/2" DR 3/4" 12 PT Deep |
| J5326 | Socket, 1/2" DR 13/16" 12 PT Deep |
| J5328 | Socket, 1/2" DR 7/8" 12 PT Deep |
| J5330 | Socket, 1/2" DR 15/16" 12 PT Deep |
| J5332 | Socket, 1/2" DR 1" 12 PT Deep |
| J5334 | Socket, 1/2" DR 1-1/16" 12 PT Deep |
| J5336 | Socket, 1/2" DR 1-1/8" 12 PT Deep |
| J5340 | Socket, 1/2" DR 1-1/4" 12 PT Deep |
| J49901/8 | Socket, Hex Bit 3/8" DR 1/8" |
| J49905/32 | Socket, Hex Bit 3/8" DR 5/32" |
| J49903/16 | Socket, Hex Bit 3/8" DR 3/16" |
| J49907/32 | Socket, Hex Bit 3/8" DR 7/32" |
| J49901/4 | Socket, Hex Bit 3/8" DR 1/4" |
| J49905/16 | Socket, Hex Bit 3/8" DR 5/16" |
| J49903/8 | Socket, Hex Bit 3/8" DR 3/8" |
| J54411/2 | Socket, Hex Bit 1/2" DR 1/2" |
| J54419/16 | Socket, Hex Bit 1/2" DR 9/16 |
| J54415/8 | Socket, Hex Bit 1/2" DR 5/8" |
| J5274A | Socket, Universal 3/8" DR 7/16" 12 PT |
| J5275A | Socket, Universal 3/8" DR 1/2" 12 PT |
| J5276A | Socket, Universal 3/8" DR 9/16" 12 PT |
| J5277A | Socket, Universal 3/8" DR 5/8" 12 PT |
| J5279A | Socket, Universal 3/8" DR 3/4" 12 PT |
| J706 | Wrench, Adjustable 6" |
| J710 | Wrench, Adjustable 10" |
| J712 | Wrench, Adjustable 12" |
| J1120 | Wrench, Box 5/16" x 3/8" 12 PT Short |
| J1122 | Wrench, Box 3/8" x 7/16" 12 PT Short |
| J1126 | Wrench, Box 1/2" x 9/16" 12 PT Short |
| J1131 | Wrench, Box 5/8" x 3/4" 12 PT Short |
| J1210A | Wrench, Combination 5/16" 12 PT |
| J1212ASD | Wrench, Combination 3/8" 12 PT |
| J1214ASD | Wrench, Combination 7/16" 12 PT |
| J1216ASD | Wrench, Combination 1/2" 12 PT |
| J1218ASD | Wrench, Combination 9/16" 12 PT |
| J1220ASD | Wrench, Combination 5/8" 12 PT |
| J1222ASD | Wrench, Combination 11/16" 12 PT |
| J1224ASD | Wrench, Combination 3/4" 12 PT |
| J1226ASD | Wrench, Combination 13/16" 12 PT |
| J1228ASD | Wrench, Combination 7/8" 12 PT |
| J1230ASD | Wrench, Combination 15/16" 12 PT |
| J1232ASD | Wrench, Combination 1" 12 PT |
| J1234ASD | Wrench, Combination 1-1/16" 12 PT |
| J1236ASD | Wrench, Combination 1-1/8" 12 PT |
| J1240ASD | Wrench, Combination 1-1/4" 12 PT |
| J3021 | Wrench, Open End 3/8" x 7/16" |
| J3026 | Wrench, Open End 1/2" x 9/16" |
| J3030 | Wrench, Open End 9/16" x 5/8" |
| J3035 | Wrench, Open End 11/16" x 3/4" |
| J3040 | Wrench, Open End 13/16" x 7/8" |

165 PC INTERMEDIATE MAINTENANCE SET WITH TOP CHEST J442719-10RD-D

Product #: J99491



- › 165 Pieces.
- › 3/8, 1/2" Drive Tools.
- › Designed for fasteners sizes 1/8" - 1-1/4".
- › Contains: 76 Sockets and Accessories, 27 Wrenches, 15 Striking and Struck Tools, 12 Pliers, 12 Screwdrivers, 23 Miscellaneous Tools.
- › Sub-sets contained: J99480, J99485.
- › Weight: 220.0 lbs..



Representative Image; Contents May Differ

165 PC INTERMEDIATE MAINTENANCE SET WITH TOP CHEST J442719-8RD

Product #: J99492



- › 165 Pieces.
- › 3/8, 1/2" Drive Tools.
- › Designed for fasteners sizes 1/8" - 1-1/4".
- › Contains: 76 Sockets and Accessories, 27 Wrenches, 15 Striking and Struck Tools, 12 Pliers, 12 Screwdrivers, 23 Miscellaneous Tools.
- › Sub-sets contained: J99480, J99485.
- › Weight: 218.0 lbs.



Representative Image; Contents May Differ



248 PC METRIC INTERMEDIATE SET

METRIC



Product #: J99730

- › 248 Pieces.
- › 1/4", 3/8", 1/2", 3/4" Drive Tools.
- › Designed for fastener sizes 4 mm - 46 mm.
- › Tools only.
- › Contains: 110 Sockets and Accessories, 45 Wrenches, 17 Striking and Struck Tools, 28 Pliers, 19 Screwdrivers, 29 Miscellaneous Tools.
- › Weight: 113.0 lbs.



Representative Image; Contents May Differ

(CONTINUED ON NEXT PAGE)

Made in USA accurate at time of printing, consult www.protoindustrial.com for updated information.

Made in USA

Made in USA with global components

PROTO



248 PC METRIC INTERMEDIATE SET (CONTINUED)



Product #: **J99730**

| Contents | Description |
|----------|---|
| J4770A | Adapter, Universal Joint 1/4" DR |
| J5270A | Adapter, Universal Joint 3/8" DR |
| J5470A | Adapter, Universal Joint 1/2" DR |
| J2126 | Bar, 12" Long 1/2" Tip |
| J2120 | Bar, Pry Aligning 18" |
| J404 | C-Clamps, Capacity 0"-4", 2 Each |
| J725/16 | Chisel, Cape 13/64" |
| J86A1/4 | Chisel, Cold 5/16" |
| J86A3/8 | Chisel, Cold 7/16" |
| J86A7/16 | Chisel, Cold 1/2" |
| J765/16 | Chisel, Diamond PT 3/16" |
| J4769 | Driver, 1/4" DR |
| J9521 | Extractor, Screw 1/8" |
| J9522 | Extractor, Screw 3/16" |
| J9523 | Extractor, Screw 15/64" |
| J9524 | Extractor, Screw 5/16" |
| J9525 | Extractor, Screw 3/8" |
| J9525B | Extractor, Screw 15/32" |
| J9526 | Extractor, Screw 9/16" |
| J9527 | Extractor, Screw 21/32" |
| J9528 | Extractor, Screw 13/16" |
| J9529 | Extractor, Screw 1-1/16" |
| J5260 | Extension, 3/8" DR 3" |
| J5260-06 | Extension, 3/8" DR 6" |
| J4759 | Extension, 1/4" DR 2" |
| J4761 | Extension, 1/4" DR 6" |
| J5460 | Extension, 1/2" DR 2-1/2" |
| J5461 | Extension, 1/2" DR 5" |
| J5463 | Extension, 1/2" DR 10" |
| J5661 | Extension, 3/4" DR 8" |
| J5663 | Extension, 3/4" DR 16" |
| J5695 | Box, Extra Heavy-Duty Set |
| 15-265 | Hacksaw, 3-7/8" |
| J1430-HB | Hammer Head |
| J1316PD | Hammer, Ball Pein 16 oz. |
| J1332PD | Hammer, Ball Pein 32 oz. |
| 57-532 | Hammer, Compo-Cast® 21 oz. |
| J4766 | Handle, Hinge 1/4" DR 5-3/4" |
| J5668 | Handle, Hinge 3/4" DR 20" |
| J5265 | Handle, Hinge 3/8" DR 8-1/2" |
| J5480G | Handle, Speed 1/2" DR |
| J4984 | Hex Key, 9 PC Metric Set |
| J5467 | Handle, Hinge 1/2" DR 15-3/4" |
| J2108 | Holder, Punch and Chisel |
| J95218 | Knife, Folding Blade |
| J18545B | Knife, Lockback 5" |
| 10-099 | Knife, Stanley® Classic 99® Retractable Blade Utility |
| J9205M | Nut Driver, 5 mm |
| J92055M | Nut Driver, 5.5 mm |
| J9206M | Nut Driver, 6 mm |
| J9207M | Nut Driver, 7 mm |
| J9208M | Nut Driver, 8 mm |
| J9209M | Nut Driver, 9 mm |
| J9210M | Nut Driver, 10 mm |
| J206G | Pliers, Diagonal Cutting with Grip 6-1/16" |
| J209G | Pliers, Diagonal Cutting with Grip 7-5/16" |

| Contents | Description |
|-------------|--|
| J227G | Pliers, Duckbill with Grip 7-25/32" |
| J272G | Pliers, End Cutting High Leverage 8-1/4" |
| J268G | Pliers, Lineman's with Grip 8-5/8" |
| J292NC | Pliers, Locking Curved 10" |
| J291NC | Pliers, Locking Straight 7" |
| J225G | Pliers, Needle-Nose Bent Nose 6-5/16" |
| J222G | Pliers, Needle-Nose Long Thin 6-1/16" |
| J226G | Pliers, Needle-Nose with Cutter 6-5/8" |
| J360B | Pliers, 12 PC Set Convertible Retaining Ring |
| J278G | Pliers, Slip-Joint with Grip 8-1/16" |
| J260SG | Pliers, Tongue and Groove 10-3/16" with Grip |
| J265SG | Pliers, Tongue and Groove 16" with Grip |
| J298 | Pliers, Wire Strippers 8-1/4" |
| J2306 | Puller, Cotter Pin Tool |
| J413/8 | Punch, Center 3/8" |
| J471/4X3/32 | Punch, Pin 3/32" |
| J475/16X1/8 | Punch, Pin 1/8" |
| J473/8X3/16 | Punch, Pin 3/16" |
| J503/16 | Punch, Starting 1/16" |
| J505/16 | Punch, Starting 1/8" |
| J503/8 | Punch, Starting 3/16" |
| J4749 | Ratchet, 1/4" DR |
| J5249 | Ratchet, 3/8" DR |
| J5449 | Ratchet, 1/2" DR |
| J5649 | Ratchet, 3/4" DR |
| J2336 | Scrapers, Gasket and Carbon |
| J88393 | Screwdriver, Phillips® #0 |
| J88313 | Screwdriver, Phillips® #1 |
| J88322 | Screwdriver, Phillips® #2 |
| J88324 | Screwdriver, Phillips® #2 |
| J88336 | Screwdriver, Phillips® #3 |
| J88348 | Screwdriver, Phillips® #4 |
| J88102 | Screwdriver, Slotted Keystone, Square 1/4" x 2" |
| J88104 | Screwdriver, Slotted Keystone, Square 1/4" x 4" |
| J88106 | Screwdriver, Slotted Keystone, Square 1/4" x 6" |
| J88108 | Screwdriver, Slotted Keystone, Square 1/4" x 8" |
| J88112 | Screwdriver, Slotted Keystone, Square 1/4" x 12" |
| J88002 | Screwdriver, Slotted Keystone, Round 1/4" x 1-1/2" |
| J303S | Snips, Aviation Straight |
| J308 | Snips, Miniature |
| J4704M | Socket, 1/4" DR 4 mm 6 PT |
| J4705M | Socket, 1/4" DR 5 mm 6 PT |
| J47055M | Socket, 1/4" DR 5.5 mm 6 PT |
| J4706M | Socket, 1/4" DR 6 mm 6 PT |
| J4707M | Socket, 1/4" DR 7 mm 6 PT |
| J4708M | Socket, 1/4" DR 8 mm 6 PT |
| J4709M | Socket, 1/4" DR 9 mm 6 PT |
| J4710M | Socket, 1/4" DR 10 mm 6 PT |
| J4711M | Socket, 1/4" DR 11 mm 6 PT |
| J4712M | Socket, 1/4" DR 12 mm 6 PT |
| J4713M | Socket, 1/4" DR 13 mm 6 PT |
| J4714M | Socket, 1/4" DR 14 mm 6 PT |
| J5208M | Socket, 3/8" DR 8 mm 12 PT |
| J5209M | Socket, 3/8" DR 9 mm 12 PT |
| J5210M | Socket, 3/8" DR 10 mm 12 PT |
| J5211M | Socket, 3/8" DR 11 mm 12 PT |

MASTER SETS



INTERMEDIATE SETS





| Contents | Description |
|----------|----------------------------------|
| J5212M | Socket, 3/8" DR 12 mm 12 PT |
| J5213M | Socket, 3/8" DR 13 mm 12 PT |
| J5214M | Socket, 3/8" DR 14 mm 12 PT |
| J5215M | Socket, 3/8" DR 15 mm 12 PT |
| J5216M | Socket, 3/8" DR 16 mm 12 PT |
| J5217M | Socket, 3/8" DR 17 mm 12 PT |
| J5218M | Socket, 3/8" DR 18 mm 12 PT |
| J5219M | Socket, 3/8" DR 19 mm 12 PT |
| J5008M | Socket, 3/8" DR 8 mm 12 PT Deep |
| J5009M | Socket, 3/8" DR 9 mm 12 PT Deep |
| J5010M | Socket, 3/8" DR 10 mm 12 PT Deep |
| J5011M | Socket, 3/8" DR 11 mm 12 PT Deep |
| J5012M | Socket, 3/8" DR 12 mm 12 PT Deep |
| J5013M | Socket, 3/8" DR 13 mm 12 PT Deep |
| J5014M | Socket, 3/8" DR 14 mm 12 PT Deep |
| J5015M | Socket, 3/8" DR 15 mm 12 PT Deep |
| J5016M | Socket, 3/8" DR 16 mm 12 PT Deep |
| J5017M | Socket, 3/8" DR 17 mm 12 PT Deep |
| J5018M | Socket, 3/8" DR 18 mm 12 PT Deep |
| J5019M | Socket, 3/8" DR 19 mm 12 PT Deep |
| J5410M | Socket, 1/2" DR 10 mm 12 PT |
| J5411M | Socket, 1/2" DR 11 mm 12 PT |
| J5412M | Socket, 1/2" DR 12 mm 12 PT |
| J5413M | Socket, 1/2" DR 13 mm 12 PT |
| J5414M | Socket, 1/2" DR 14 mm 12 PT |
| J5415M | Socket, 1/2" DR 15 mm 12 PT |
| J5416M | Socket, 1/2" DR 16 mm 12 PT |
| J5417M | Socket, 1/2" DR 17 mm 12 PT |
| J5418M | Socket, 1/2" DR 18 mm 12 PT |
| J5419M | Socket, 1/2" DR 19 mm 12 PT |
| J5420M | Socket, 1/2" DR 20 mm 12 PT |
| J5421M | Socket, 1/2" DR 21 mm 12 PT |
| J5422M | Socket, 1/2" DR 22 mm 12 PT |
| J5423M | Socket, 1/2" DR 23 mm 12 PT |
| J5424M | Socket, 1/2" DR 24 mm 12 PT |
| J5425M | Socket, 1/2" DR 25 mm 12 PT |
| J5426M | Socket, 1/2" DR 26 mm 12 PT |
| J5316M | Socket, 1/2" DR 16 mm 12 PT Deep |
| J5317M | Socket, 1/2" DR 17 mm 12 PT Deep |
| J5318M | Socket, 1/2" DR 18 mm 12 PT Deep |
| J5319M | Socket, 1/2" DR 19 mm 12 PT Deep |
| J5320M | Socket, 1/2" DR 20 mm 12 PT Deep |
| J5321M | Socket, 1/2" DR 21 mm 12 PT Deep |
| J5322M | Socket, 1/2" DR 22 mm 12 PT Deep |
| J5324M | Socket, 1/2" DR 24 mm 12 PT Deep |
| J5325M | Socket, 1/2" DR 25 mm 12 PT Deep |
| J5326M | Socket, 1/2" DR 26 mm 12 PT Deep |
| J5524M | Socket, 3/4" DR 24 mm 12 PT |
| J5525M | Socket, 3/4" DR 25 mm 12 PT |
| J5526M | Socket, 3/4" DR 26 mm 12 PT |
| J5527M | Socket, 3/4" DR 27 mm 12 PT |
| J5528M | Socket, 3/4" DR 28 mm 12 PT |
| J5529M | Socket, 3/4" DR 29 mm 12 PT |
| J5530M | Socket, 3/4" DR 30 mm 12 PT |
| J5531M | Socket, 3/4" DR 31 mm 12 PT |
| J5532M | Socket, 3/4" DR 32 mm 12 PT |
| J5535M | Socket, 3/4" DR 35 mm 12 PT |
| J5536M | Socket, 3/4" DR 36 mm 12 PT |
| J5538M | Socket, 3/4" DR 38 mm 12 PT |

| Contents | Description |
|-----------|--|
| J5541M | Socket, 3/4" DR 41 mm 12 PT |
| J5542M | Socket, 3/4" DR 42 mm 12 PT |
| J5546M | Socket, 3/4" DR 46 mm 12 PT |
| J4990-4M | Socket, Hex Bit 3/8" DR 4 mm |
| J4990-5M | Socket, Hex Bit 3/8" DR 5 mm |
| J4990-6M | Socket, Hex Bit 3/8" DR 6 mm |
| J4990-7M | Socket, Hex Bit 3/8" DR 7 mm |
| J4990-8M | Socket, Hex Bit 3/8" DR 8 mm |
| J4990-9M | Socket, Hex Bit 3/8" DR 9 mm |
| J4990-10M | Socket, Hex Bit 3/8" DR 10 mm |
| J5441-12M | Socket, Hex Bit 1/2" DR 12 mm |
| J5441-14M | Socket, Hex Bit 1/2" DR 14 mm |
| J5441-17M | Socket, Hex Bit 1/2" DR 17 mm |
| 33-212 | Tape Rule, Stanley® Powerlock® w/Metal Case 1/2"x12" |
| J706 | Wrench, Adjustable 6" |
| J708 | Wrench, Adjustable 8" |
| J710 | Wrench, Adjustable 10" |
| J712 | Wrench, Adjustable 12" |
| J1207MA | Wrench, Combination 7 mm 12 PT |
| J1208MA | Wrench, Combination 8 mm 12 PT |
| J1209MA | Wrench, Combination 9 mm 12 PT |
| J1210MASD | Wrench, Combination 10 mm 12 PT |
| J1211MASD | Wrench, Combination 11 mm 12 PT |
| J1212MASD | Wrench, Combination 12 mm 12 PT |
| J1213MASD | Wrench, Combination 13 mm 12 PT |
| J1214MASD | Wrench, Combination 14 mm 12 PT |
| J1215MASD | Wrench, Combination 15 mm 12 PT |
| J1216MASD | Wrench, Combination 16 mm 12 PT |
| J1217MASD | Wrench, Combination 17 mm 12 PT |
| J1218MASD | Wrench, Combination 18 mm 12 PT |
| J1219MASD | Wrench, Combination 19 mm 12 PT |
| J1220MASD | Wrench, Combination 20 mm 12 PT |
| J1221MASD | Wrench, Combination 21 mm 12 PT |
| J1222MASD | Wrench, Combination 22 mm 12 PT |
| J1223MASD | Wrench, Combination 23 mm 12 PT |
| J1224MASD | Wrench, Combination 24 mm 12 PT |
| J3710M | Wrench, Flare Nut 10 mm x 12 mm |
| J3707M | Wrench, Flare Nut 7 mm x 8 mm |
| J3709M | Wrench, Flare Nut 9 mm x 11 mm |
| J3713M | Wrench, Flare Nut 13 mm x 14 mm |
| J3715M | Wrench, Flare Nut 15 mm x 17 mm |
| J30607 | Wrench, Open End 6 mm x 7 mm |
| J30809 | Wrench, Open End 8 mm x 9 mm |
| J31011 | Wrench, Open End 10 mm x 11 mm |
| J31213 | Wrench, Open End 12 mm x 13 mm |
| J31415 | Wrench, Open End 14 mm x 15 mm |
| J31617 | Wrench, Open End 16 mm x 17 mm |
| J31819 | Wrench, Open End 18 mm x 19 mm |
| J32022 | Wrench, Open End 20 mm x 22 mm |
| J32123 | Wrench, Open End 21 mm x 23 mm |
| J32426 | Wrench, Open End 24 mm x 26 mm |
| J810HD | Wrench, Pipe Heavy-Duty 10" |
| J814HD | Wrench, Pipe Heavy-Duty 14" |
| J818HD | Wrench, Pipe Heavy-Duty 18" |
| J1191M-A | Wrench, Ratcheting Box 7 mm x 8 mm |
| J1192M-A | Wrench, Ratcheting Box 9 mm x 10 mm |
| J1193MA-A | Wrench, Ratcheting Box 11 mm x 12 mm |
| J1194MA-A | Wrench, Ratcheting Box 13 mm x 14 mm |
| J1195M-A | Wrench, Ratcheting Box 15 mm x 17 mm |

248 PC METRIC INTERMEDIATE SET WITH ROLLER CABINET J442742-8RD

METRIC

Product #: J99731



- › 248 Pieces.
- › 1/4", 3/8", 1/2", 3/4" Drive Tools.
- › Designed for fastener sizes 4 mm - 46 mm.
- › Contains: 110 Sockets and Accessories, 45 Wrenches, 17 Striking and Struck Tools, 26 Pliers, 19 Screwdrivers, 31 Miscellaneous Tools.
- › Weight: 300.0 lbs.



Representative Image; Contents May Differ

METRIC



248 PC METRIC INTERMEDIATE SET WITH ROLLER CABINET J453441-8RD

Product #: J99732

- › 248 Pieces.
- › 1/4", 3/8", 1/2", 3/4" Drive Tools.
- › Designed for fastener sizes 4 mm - 46 mm.
- › Contains: 110 Sockets and Accessories, 45 Wrenches, 17 Striking and Struck Tools, 26 Pliers, 19 Screwdrivers, 31 Miscellaneous Tools.
- › Weight: 422.0 lbs.



Representative Image; Contents May Differ



229 PC METRIC INTERMEDIATE SET

METRIC



Product #: J99550

- › 229 Pieces.
- › 1/4", 3/8", 1/2" Drive Tools.
- › Designed for fasteners sizes 4 mm - 26 mm.
- › Tools only.
- › Contains: 111 Sockets and Accessories, 42 Wrenches, 16 Striking and Struck Tools, 17 Pliers, 19 Screwdrivers, 24 Miscellaneous Tools.
- › Weight: 93.0 lbs.



Representative Image; Contents May Differ

(CONTINUED ON NEXT PAGE)

Made in USA accurate at time of printing, consult www.protoindustrial.com for updated information.

Made in USA

Made in USA with global components

PROTO

MASTER SETS



INTERMEDIATE SETS

229 PC METRIC INTERMEDIATE SET (CONTINUED)



Product #: J99550

| Contents | Description |
|----------|---|
| J4770A | Adapter, Universal Joint 1/4" DR |
| J5270A | Adapter, Universal Joint 3/8" DR |
| J5470A | Adapter, Universal Joint 1/2" DR |
| J2126 | Bar, 12" Long 1/2" Tip |
| J2120 | Bar, Pry Aligning 18" |
| J404 | C-Clamps, Capacity 0"-4", 2 Each |
| J725/16 | Chisel, Cape 13/64" |
| J86A1/4 | Chisel, Cold 5/16" |
| J86A3/8 | Chisel, Cold 7/16" |
| J86A7/16 | Chisel, Cold 1/2" |
| J765/16 | Chisel, Diamond PT 3/16" |
| J4769 | Driver, 1/4" DR |
| J9521 | Extractor, Screw 1/8" |
| J9522 | Extractor, Screw 3/16" |
| J9524 | Extractor, Screw 5/16" |
| J9523 | Extractor, Screw 15/64" |
| J9525 | Extractor, Screw 3/8" |
| J4759 | Extension, 1/4" DR 2" |
| J4761 | Extension, 1/4" DR 6" |
| J5260 | Extension, 3/8" DR 3" |
| J5260-06 | Extension, 3/8" DR 6" |
| J5460 | Extension, 1/2" DR 2-1/2" |
| J5461 | Extension, 1/2" DR 5" |
| J5463 | Extension, 1/2" DR 10" |
| 15-265 | Hacksaw, 3-7/8" |
| J1316PD | Hammer, Ball Pein 16 oz. |
| J1332PD | Hammer, Ball Pein 32 oz. |
| 57-532 | Hammer, Compo-Cast® 21 oz. |
| J4766 | Handle, Hinge 1/4" DR 5-3/4" |
| J5265 | Handle, Hinge 3/8" DR 8-1/2" |
| J5280G | Handle, Speed 3/8" DR |
| J5480G | Handle, Speed 1/2" DR |
| J4984 | Hex Key, 9 PC Metric Set |
| J5467 | Handle, Hinge 1/2" DR 15-3/4" |
| J2108 | Holder, Punch and Chisel |
| J95218 | Knife, Folding Blade |
| J18545B | Knife, Lockback 5" |
| 10-099 | Knife, Stanley® Classic 99® Retractable Blade Utility |
| J308 | Miniature Snips |
| J9205M | Nut Driver, 5 mm |
| J92055M | Nut Driver, 5.5 mm |
| J9206M | Nut Driver, 6 mm |
| J9207M | Nut Driver, 7 mm |
| J9208M | Nut Driver, 8 mm |
| J9209M | Nut Driver, 9 mm |
| J9210M | Nut Driver, 10 mm |
| J206G | Pliers, Diagonal Cutting with Grip 6-1/16" |
| J209G | Pliers, Diagonal Cutting with Grip 7-5/16" |
| J227G | Pliers, Duckbill with Grip 7-25/32" |
| J272G | Pliers, End Cutting High Leverage 8-1/4" |
| J268G | Pliers, Lineman's with Grip 8-5/8" |
| J292NC | Pliers, Locking Curved 10" |
| J291NC | Pliers, Locking Straight 7" |
| J225G | Pliers, Needle-Nose Bent Nose 6-5/16" |
| J222G | Pliers, Needle-Nose Long Thin 6-1/16" |
| J226G | Pliers, Needle-Nose with Cutter 6-5/8" |

| Contents | Description |
|-------------|---|
| J278G | Pliers, Slip-Joint with Grip 8-1/16" |
| J260SG | Pliers, Tongue and Groove 10-3/16" with Grip |
| J298 | Pliers, Wire Strippers 8-1/4" |
| J2306 | Puller, Cotter Pin Tool |
| J413/8 | Punch, Center 3/8" |
| J471/4X3/32 | Punch, Pin 3/32" |
| J475/16X1/8 | Punch, Pin 1/8" |
| J473/8X3/16 | Punch, Pin 3/16" |
| J503/16 | Punch, Starting 1/16" |
| J505/16 | Punch, Starting 1/8" |
| J503/8 | Punch, Starting 3/16" |
| J4749 | Ratchet, 1/4" DR |
| J5249 | Ratchet, 3/8" DR |
| J5449 | Ratchet, 1/2" DR |
| J2336 | Scrapers, Gasket and Carbon |
| J88393 | Screwdriver, Phillips® #0 |
| J88313 | Screwdriver, Phillips® #1 |
| J88322 | Screwdriver, Phillips® #2 |
| J88324 | Screwdriver, Phillips® #2 |
| J88336 | Screwdriver, Phillips® #3 |
| J88348 | Screwdriver, Phillips® #4 |
| J88102 | Screwdriver, Slotted Keystone, Square 1/4" x 2" |
| J88104 | Screwdriver, Slotted Keystone, Square 1/4" x 4" |
| J88106 | Screwdriver, Slotted Keystone, Square 1/4" x 6" |
| J88108 | Screwdriver, Slotted Keystone, Square 1/4" x 8" |
| J88112 | Screwdriver, Slotted Keystone, Square 1/4" x 12" |
| J88002 | Screwdriver, Slotted Keystone, Round 1/4" x 1-1/2" |
| J380 | Pliers, 6 PC Retaining Ring Set with Replacement Tips |
| J303S | Snips, Aviation Straight |
| J4704M | Socket, 1/4" DR 4 mm 6 PT |
| J4705M | Socket, 1/4" DR 5 mm 6 PT |
| J47055M | Socket, 1/4" DR 5.5 mm 6 PT |
| J4706M | Socket, 1/4" DR 6 mm 6 PT |
| J4707M | Socket, 1/4" DR 7 mm 6 PT |
| J4708M | Socket, 1/4" DR 8 mm 6 PT |
| J4709M | Socket, 1/4" DR 9 mm 6 PT |
| J4710M | Socket, 1/4" DR 10 mm 6 PT |
| J4711M | Socket, 1/4" DR 11 mm 6 PT |
| J4712M | Socket, 1/4" DR 12 mm 6 PT |
| J4713M | Socket, 1/4" DR 13 mm 6 PT |
| J4714M | Socket, 1/4" DR 14 mm 6 PT |
| J4704LM | Socket, 1/4" DR 4 mm 6 PT Deep |
| J4705LM | Socket, 1/4" DR 5 mm 6 PT Deep |
| J47055LM | Socket, 1/4" DR 5.5 mm 6 PT Deep |
| J4706LM | Socket, 1/4" DR 6 mm 6 PT Deep |
| J4707LM | Socket, 1/4" DR 7 mm 6 PT Deep |
| J4708LM | Socket, 1/4" DR 8 mm 6 PT Deep |
| J4709LM | Socket, 1/4" DR 9 mm 6 PT Deep |
| J4710LM | Socket, 1/4" DR 10 mm 6 PT Deep |
| J4711LM | Socket, 1/4" DR 11 mm 6 PT Deep |
| J4712LM | Socket, 1/4" DR 12 mm 6 PT Deep |
| J4713LM | Socket, 1/4" DR 13 mm 6 PT Deep |
| J4714LM | Socket, 1/4" DR 14 mm 6 PT Deep |
| J5208M | Socket, 3/8" DR 8 mm 12 PT |
| J5209M | Socket, 3/8" DR 9 mm 12 PT |

MASTER SETS



INTERMEDIATE SETS





| Contents | Description |
|----------|----------------------------------|
| J5210M | Socket, 3/8" DR 10 mm 12 PT |
| J5211M | Socket, 3/8" DR 11 mm 12 PT |
| J5212M | Socket, 3/8" DR 12 mm 12 PT |
| J5213M | Socket, 3/8" DR 13 mm 12 PT |
| J5214M | Socket, 3/8" DR 14 mm 12 PT |
| J5215M | Socket, 3/8" DR 15 mm 12 PT |
| J5216M | Socket, 3/8" DR 16 mm 12 PT |
| J5217M | Socket, 3/8" DR 17 mm 12 PT |
| J5218M | Socket, 3/8" DR 18 mm 12 PT |
| J5219M | Socket, 3/8" DR 19 mm 12 PT |
| J5008M | Socket, 3/8" DR 8 mm 12 PT Deep |
| J5009M | Socket, 3/8" DR 9 mm 12 PT Deep |
| J5010M | Socket, 3/8" DR 10 mm 12 PT Deep |
| J5011M | Socket, 3/8" DR 11 mm 12 PT Deep |
| J5012M | Socket, 3/8" DR 12 mm 12 PT Deep |
| J5013M | Socket, 3/8" DR 13 mm 12 PT Deep |
| J5014M | Socket, 3/8" DR 14 mm 12 PT Deep |
| J5015M | Socket, 3/8" DR 15 mm 12 PT Deep |
| J5016M | Socket, 3/8" DR 16 mm 12 PT Deep |
| J5017M | Socket, 3/8" DR 17 mm 12 PT Deep |
| J5018M | Socket, 3/8" DR 18 mm 12 PT Deep |
| J5019M | Socket, 3/8" DR 19 mm 12 PT Deep |
| J5410M | Socket, 1/2" DR 10 mm 12 PT |
| J5411M | Socket, 1/2" DR 11 mm 12 PT |
| J5412M | Socket, 1/2" DR 12 mm 12 PT |
| J5413M | Socket, 1/2" DR 13 mm 12 PT |
| J5414M | Socket, 1/2" DR 14 mm 12 PT |
| J5415M | Socket, 1/2" DR 15 mm 12 PT |
| J5416M | Socket, 1/2" DR 16 mm 12 PT |
| J5417M | Socket, 1/2" DR 17 mm 12 PT |
| J5418M | Socket, 1/2" DR 18 mm 12 PT |
| J5419M | Socket, 1/2" DR 19 mm 12 PT |
| J5420M | Socket, 1/2" DR 20 mm 12 PT |
| J5421M | Socket, 1/2" DR 21 mm 12 PT |
| J5422M | Socket, 1/2" DR 22 mm 12 PT |
| J5423M | Socket, 1/2" DR 23 mm 12 PT |
| J5424M | Socket, 1/2" DR 24 mm 12 PT |
| J5425M | Socket, 1/2" DR 25 mm 12 PT |
| J5426M | Socket, 1/2" DR 26 mm 12 PT |
| J5316M | Socket, 1/2" DR 16 mm 12 PT Deep |
| J5317M | Socket, 1/2" DR 17 mm 12 PT Deep |
| J5318M | Socket, 1/2" DR 18 mm 12 PT Deep |
| J5319M | Socket, 1/2" DR 19 mm 12 PT Deep |
| J5320M | Socket, 1/2" DR 20 mm 12 PT Deep |
| J5321M | Socket, 1/2" DR 21 mm 12 PT Deep |
| J5322M | Socket, 1/2" DR 22 mm 12 PT Deep |
| J5324M | Socket, 1/2" DR 24 mm 12 PT Deep |
| J5325M | Socket, 1/2" DR 25 mm 12 PT Deep |
| J5326M | Socket, 1/2" DR 26 mm 12 PT Deep |
| J4990-4M | Socket, Hex Bit 3/8" DR 4 mm |
| J4990-5M | Socket, Hex Bit 3/8" DR 5 mm |
| J4990-6M | Socket, Hex Bit 3/8" DR 6 mm |
| J4990-7M | Socket, Hex Bit 3/8" DR 7 mm |
| J4990-8M | Socket, Hex Bit 3/8" DR 8 mm |
| J4990-9M | Socket, Hex Bit 3/8" DR 9 mm |

| Contents | Description |
|-----------|---|
| J4990-10M | Socket, Hex Bit 3/8" DR 10 mm |
| J5441-12M | Socket, Hex Bit 1/2" DR 12 mm |
| J5441-14M | Socket, Hex Bit 1/2" DR 14 mm |
| J5441-17M | Socket, Hex Bit 1/2" DR 17 mm |
| J5272AM | Socket, Universal 3/8" DR 9 mm 12 PT |
| J5273AM | Socket, Universal 3/8" DR 10 mm 12 PT |
| J5274AM | Socket, Universal 3/8" DR 11 mm 12 PT |
| J5275AM | Socket, Universal 3/8" DR 12 mm 12 PT |
| J5276AM | Socket, Universal 3/8" DR 13 mm 12 PT |
| J5277AM | Socket, Universal 3/8" DR 14 mm 12 PT |
| J5278AM | Socket, Universal 3/8" DR 15 mm 12 PT |
| 33-212 | Tape Rule, Stanley® Powerlock® with Metal Case 1/2"x12' |
| J706 | Wrench, Adjustable 6" |
| J708 | Wrench, Adjustable 8" |
| J710 | Wrench, Adjustable 10" |
| J1207MA | Wrench, Combination 7 mm 12 PT |
| J1208MA | Wrench, Combination 8 mm 12 PT |
| J1209MA | Wrench, Combination 9 mm 12 PT |
| J1210MASD | Wrench, Combination 10 mm 12 PT |
| J1211MASD | Wrench, Combination 11 mm 12 PT |
| J1212MASD | Wrench, Combination 12 mm 12 PT |
| J1213MASD | Wrench, Combination 13 mm 12 PT |
| J1214MASD | Wrench, Combination 14 mm 12 PT |
| J1215MASD | Wrench, Combination 15 mm 12 PT |
| J1216MASD | Wrench, Combination 16 mm 12 PT |
| J1217MASD | Wrench, Combination 17 mm 12 PT |
| J1218MASD | Wrench, Combination 18 mm 12 PT |
| J1219MASD | Wrench, Combination 19 mm 12 PT |
| J1220MASD | Wrench, Combination 20 mm 12 PT |
| J1221MASD | Wrench, Combination 21 mm 12 PT |
| J1222MASD | Wrench, Combination 22 mm 12 PT |
| J1223MASD | Wrench, Combination 23 mm 12 PT |
| J1224MASD | Wrench, Combination 24 mm 12 PT |
| J3707M | Wrench, Flare Nut 7 mm x 8 mm |
| J3709M | Wrench, Flare Nut 9 mm x 11 mm |
| J3710M | Wrench, Flare Nut 10 mm x 12 mm |
| J3713M | Wrench, Flare Nut 13 mm x 14 mm |
| J3715M | Wrench, Flare Nut 15 mm x 17 mm |
| J30607 | Wrench, Open End 6 mm x 7 mm |
| J30809 | Wrench, Open End 8 mm x 9 mm |
| J31011 | Wrench, Open End 10 mm x 11 mm |
| J31213 | Wrench, Open End 12 mm x 13 mm |
| J31415 | Wrench, Open End 14 mm x 15 mm |
| J31617 | Wrench, Open End 16 mm x 17 mm |
| J31819 | Wrench, Open End 18 mm x 19 mm |
| J32022 | Wrench, Open End 20 mm x 22 mm |
| J32123 | Wrench, Open End 21 mm x 23 mm |
| J32426 | Wrench, Open End 24 mm x 26 mm |
| J810HD | Wrench, Pipe Heavy-Duty 10" |
| J1191M-A | Wrench, Ratcheting Box 7 mm x 8 mm |
| J1192M-A | Wrench, Ratcheting Box 9 mm x 10 mm |
| J1193MA-A | Wrench, Ratcheting Box 11 mm x 12 mm |
| J1194MA-A | Wrench, Ratcheting Box 13 mm x 14 mm |
| J1195M-A | Wrench, Ratcheting Box 15 mm x 17 mm |

229 PC METRIC INTERMEDIATE SET WITH TOP CHEST J442719-10RD-D

METRIC

Product #: J99551



- › 229 Pieces.
- › 1/4", 3/8", 1/2" Drive Tools.
- › Designed for fasteners sizes 4 mm - 26 mm.
- › Contains: 111 Sockets and Accessories, 42 Wrenches, 16 Striking and Struck Tools, 15 Pliers, 19 Screwdrivers, 26 Miscellaneous Tools.
- › Weight: 235.0 lbs.



Representative Image; Contents May Differ

METRIC



229 PC METRIC INTERMEDIATE SET WITH TOP CHEST J442719-8RD

Product #: J99552

- › 229 Pieces.
- › 1/4", 3/8", 1/2" Drive Tools.
- › Designed for fasteners sizes 4 mm - 26 mm.
- › Contains: 111 Sockets and Accessories, 42 Wrenches, 16 Striking and Struck Tools, 15 Pliers, 19 Screwdrivers, 26 Miscellaneous Tools.
- › Weight: 233.0 lbs.



Representative Image; Contents May Differ

METRIC



157 PC METRIC INTERMEDIATE SET



Product #: J99430

- › 157 Pieces.
- › 3/8", 1/2" Drive Tools.
- › Designed for fastener sizes 4 mm - 26 mm.

- › Contains: 73 Sockets and Accessories, 27 Wrenches, 15 Striking and Struck Tools, 13 Pliers, 12 Screwdrivers, 17 Miscellaneous Tools.
- › Weight: 61.0 lbs.



Representative Image; Contents May Differ

| Contents | Description |
|-------------|--|
| J5270A | Adapter, Universal Joint 3/8" DR |
| J5470A | Adapter, Universal Joint 1/2" DR |
| J2126 | Bar, 12" Long 1/2" Tip |
| J2120 | Bar, Pry Aligning 18" |
| J725/16 | Chisel, Cape 13/64" |
| J86A1/4 | Chisel, Cold 5/16" |
| J86A3/8 | Chisel, Cold 7/16" |
| J86A7/16 | Chisel, Cold 1/2" |
| J765/16 | Chisel, Diamond PT 3/16" |
| J9521 | Extractor, Screw 1/8" |
| J9522 | Extractor, Screw 3/16" |
| J9525 | Extractor, Screw 3/8" |
| J9524 | Extractor, Screw 5/16" |
| J9523 | Extractor, Screw 15/64" |
| J5260 | Extension, 3/8" DR 3" |
| J5260-06 | Extension, 3/8" DR 6" |
| J5460 | Extension, 1/2" DR 2-1/2" |
| J5461 | Extension, 1/2" DR 5" |
| J5463 | Extension, 1/2" DR 10" |
| 15-265 | Hacksaw, 3-7/8" |
| J1316PD | Hammer, Ball Pein 16 oz. |
| 57-532 | Hammer, Compo-Cast® 21 oz. |
| J5265 | Handle, Hinge 3/8" DR 8-1/2" |
| J5467 | Handle, Hinge 1/2" DR 15-3/4" |
| J5480G | Handle, Speed 1/2" DR |
| J4984 | Hex Key, 9 PC Metric Set |
| J2108 | Holder, Punch and Chisel |
| J206G | Pliers, Diagonal Cutting with Grip 6-1/16" |
| J209G | Pliers, Diagonal Cutting with Grip 7-5/16" |
| J272G | Pliers, End Cutting High Leverage 8-1/4" |
| J268G | Pliers, Lineman's with Grip 8-5/8" |
| J292NC | Pliers, Locking Curved 10" |
| J291NC | Pliers, Locking Straight 7" |
| J226G | Pliers, Needle-Nose with Cutter 6-5/8" |
| J278G | Pliers, Slip-Joint with Grip 8-1/16" |
| J260SG | Pliers, Tongue and Groove 10-3/16" with Grip |
| J298 | Pliers, Wire Strippers 8-1/4" |
| J413/8 | Punch, Center 3/8" |
| J471/4X3/32 | Punch, Pin 3/32" |
| J475/16X1/8 | Punch, Pin 1/8" |
| J473/8X3/16 | Punch, Pin 3/16" |
| J503/16 | Punch, Starting 1/16" |
| J505/16 | Punch, Starting 1/8" |
| J503/8 | Punch, Starting 3/16" |
| J5249 | Ratchet, 3/8" DR |
| J5449 | Ratchet, 1/2" DR |
| J2336 | Scrapers, Gasket and Carbon |
| J88393 | Screwdriver, Phillips® #0 |
| J88313 | Screwdriver, Phillips® #1 |
| J88324 | Screwdriver, Phillips® #2 |
| J88322 | Screwdriver, Phillips® #2 |

(CONTINUED ON NEXT PAGE)



157 PC METRIC INTERMEDIATE SET (CONTINUED)

Product #: **J99430**



| Contents | Description |
|----------|---|
| J88336 | Screwdriver, Phillips® #3 |
| J88348 | Screwdriver, Phillips® #4 |
| J88102 | Screwdriver, Slotted Keystone, Square 1/4" x 2" |
| J88104 | Screwdriver, Slotted Keystone, Square 1/4" x 4" |
| J88106 | Screwdriver, Slotted Keystone, Square 1/4" x 6" |
| J88108 | Screwdriver, Slotted Keystone, Square 1/4" x 8" |
| J88112 | Screwdriver, Slotted Keystone, Square 1/4" x 12" |
| J88002 | Screwdriver, Slotted Keystone, Round 1/4" x 1-1/2" |
| J380 | Pliers, 6 PC Retaining Ring Set with Replacement Tips |
| J303S | Snips, Aviation Straight |
| J5208M | Socket, 3/8" DR 8 mm 12 PT |
| J5209M | Socket, 3/8" DR 9 mm 12 PT |
| J5210M | Socket, 3/8" DR 10 mm 12 PT |
| J5211M | Socket, 3/8" DR 11 mm 12 PT |
| J5212M | Socket, 3/8" DR 12 mm 12 PT |
| J5213M | Socket, 3/8" DR 13 mm 12 PT |
| J5214M | Socket, 3/8" DR 14 mm 12 PT |
| J5215M | Socket, 3/8" DR 15 mm 12 PT |
| J5216M | Socket, 3/8" DR 16 mm 12 PT |
| J5217M | Socket, 3/8" DR 17 mm 12 PT |
| J5218M | Socket, 3/8" DR 18 mm 12 PT |
| J5219M | Socket, 3/8" DR 19 mm 12 PT |
| J5008M | Socket, 3/8" DR 8 mm 12 PT Deep |
| J5009M | Socket, 3/8" DR 9 mm 12 PT Deep |
| J5010M | Socket, 3/8" DR 10 mm 12 PT Deep |
| J5011M | Socket, 3/8" DR 11 mm 12 PT Deep |
| J5012M | Socket, 3/8" DR 12 mm 12 PT Deep |
| J5013M | Socket, 3/8" DR 13 mm 12 PT Deep |
| J5014M | Socket, 3/8" DR 14 mm 12 PT Deep |
| J5015M | Socket, 3/8" DR 15 mm 12 PT Deep |
| J5016M | Socket, 3/8" DR 16 mm 12 PT Deep |
| J5017M | Socket, 3/8" DR 17 mm 12 PT Deep |
| J5018M | Socket, 3/8" DR 18 mm 12 PT Deep |
| J5019M | Socket, 3/8" DR 19 mm 12 PT Deep |
| J5410M | Socket, 1/2" DR 10 mm 12 PT |
| J5411M | Socket, 1/2" DR 11 mm 12 PT |
| J5412M | Socket, 1/2" DR 12 mm 12 PT |
| J5413M | Socket, 1/2" DR 13 mm 12 PT |
| J5414M | Socket, 1/2" DR 14 mm 12 PT |
| J5415M | Socket, 1/2" DR 15 mm 12 PT |
| J5416M | Socket, 1/2" DR 16 mm 12 PT |
| J5417M | Socket, 1/2" DR 17 mm 12 PT |
| J5418M | Socket, 1/2" DR 18 mm 12 PT |
| J5419M | Socket, 1/2" DR 19 mm 12 PT |
| J5420M | Socket, 1/2" DR 20 mm 12 PT |
| J5421M | Socket, 1/2" DR 21 mm 12 PT |
| J5422M | Socket, 1/2" DR 22 mm 12 PT |
| J5423M | Socket, 1/2" DR 23 mm 12 PT |
| J5424M | Socket, 1/2" DR 24 mm 12 PT |

| Contents | Description |
|-----------|----------------------------------|
| J5425M | Socket, 1/2" DR 25 mm 12 PT |
| J5426M | Socket, 1/2" DR 26 mm 12 PT |
| J5316M | Socket, 1/2" DR 16 mm 12 PT Deep |
| J5317M | Socket, 1/2" DR 17 mm 12 PT Deep |
| J5318M | Socket, 1/2" DR 18 mm 12 PT Deep |
| J5319M | Socket, 1/2" DR 19 mm 12 PT Deep |
| J5320M | Socket, 1/2" DR 20 mm 12 PT Deep |
| J5321M | Socket, 1/2" DR 21 mm 12 PT Deep |
| J5322M | Socket, 1/2" DR 22 mm 12 PT Deep |
| J5324M | Socket, 1/2" DR 24 mm 12 PT Deep |
| J5325M | Socket, 1/2" DR 25 mm 12 PT Deep |
| J5326M | Socket, 1/2" DR 26 mm 12 PT Deep |
| J4990-4M | Socket, Hex Bit 3/8" DR 4 mm |
| J4990-5M | Socket, Hex Bit 3/8" DR 5 mm |
| J4990-6M | Socket, Hex Bit 3/8" DR 6 mm |
| J4990-7M | Socket, Hex Bit 3/8" DR 7 mm |
| J4990-8M | Socket, Hex Bit 3/8" DR 8 mm |
| J4990-9M | Socket, Hex Bit 3/8" DR 9 mm |
| J4990-10M | Socket, Hex Bit 3/8" DR 10 mm |
| J5441-12M | Socket, Hex Bit 1/2" DR 12 mm |
| J5441-14M | Socket, Hex Bit 1/2" DR 14 mm |
| J5441-17M | Socket, Hex Bit 1/2" DR 17 mm |
| J706 | Wrench, Adjustable 6" |
| J710 | Wrench, Adjustable 10" |
| J712 | Wrench, Adjustable 12" |
| J1207MA | Wrench, Combination 7 mm 12 PT |
| J1208MA | Wrench, Combination 8 mm 12 PT |
| J1209MA | Wrench, Combination 9 mm 12 PT |
| J1210MASD | Wrench, Combination 10 mm 12 PT |
| J1211MASD | Wrench, Combination 11 mm 12 PT |
| J1212MASD | Wrench, Combination 12 mm 12 PT |
| J1213MASD | Wrench, Combination 13 mm 12 PT |
| J1214MASD | Wrench, Combination 14 mm 12 PT |
| J1215MASD | Wrench, Combination 15 mm 12 PT |
| J1216MASD | Wrench, Combination 16 mm 12 PT |
| J1217MASD | Wrench, Combination 17 mm 12 PT |
| J1218MASD | Wrench, Combination 18 mm 12 PT |
| J1219MASD | Wrench, Combination 19 mm 12 PT |
| J1220MASD | Wrench, Combination 20 mm 12 PT |
| J1221MASD | Wrench, Combination 21 mm 12 PT |
| J1222MASD | Wrench, Combination 22 mm 12 PT |
| J1223MASD | Wrench, Combination 23 mm 12 PT |
| J1224MASD | Wrench, Combination 24 mm 12 PT |
| J30809 | Wrench, Open End 8 mm x 9 mm |
| J31011 | Wrench, Open End 10 mm x 11 mm |
| J31213 | Wrench, Open End 12 mm x 13 mm |
| J31415 | Wrench, Open End 14 mm x 15 mm |
| J31617 | Wrench, Open End 16 mm x 17 mm |
| J31819 | Wrench, Open End 18 mm x 19 mm |



157 PC METRIC INTERMEDIATE SET WITH TOP CHEST J442719-10RD-D

Product #: J99431

- › 157 Pieces.
- › 3/8", 1/2" Drive Tools.
- › Designed for fastener sizes 4 mm - 26 mm.
- › Contains: 72 Sockets and Accessories, 27 Wrenches, 15 Striking and Struck Tools, 12 Pliers, 12 Screwdrivers, 19 Miscellaneous Tools.
- › Weight: 203.0 lbs.



157 PC METRIC INTERMEDIATE SET WITH TOP CHEST J442719-8RD

Product #: J99432

- › 157 Pieces.
- › 3/8", 1/2" Drive Tools.
- › Designed for fastener sizes 4 mm - 26 mm.
- › Contains: 72 Sockets and Accessories, 27 Wrenches, 15 Striking and Struck Tools, 12 Pliers, 12 Screwdrivers, 19 Miscellaneous Tools.
- › Weight: 201.0 lbs.



METRIC



Representative Image; Contents May Differ

METRIC



Representative Image; Contents May Differ



164 PC STARTER SET

Product #: J99700

- › 164 Pieces.
- › 1/4", 3/8", 1/2", 3/4" Drive Tools.
- › Designed for fastener sizes 3/16" - 2".
- › Tools only.

- › Contains: 85 Sockets and Accessories, 19 Wrenches, 16 Striking and Struck Tools, 12 Pliers, 12 Screwdrivers, 20 Miscellaneous Tools.
- › Weight: 140.0 lbs.



Representative Image; Contents May Differ

| Contents | Description |
|-------------|---|
| J5496-NA | Box, 19" Set |
| J4770A | Adapter, Universal Joint 1/4" DR |
| J5270A | Adapter, Universal Joint 3/8" DR |
| J5470A | Adapter, Universal Joint 1/2" DR |
| J2126 | Bar, 12" Long 1/2" Tip |
| J2120 | Bar, Pry Aligning 18" |
| J404 | C-Clamps, Capacity 0"-4", 2 Each |
| J725/16 | Chisel, Cape 13/64" |
| J86A1/4 | Chisel, Cold 5/16" |
| J86A3/8 | Chisel, Cold 7/16" |
| J86A7/16 | Chisel, Cold 1/2" |
| J765/16 | Chisel, Diamond PT 3/16" |
| J4769 | Driver, 1/4" DR |
| J9521 | Extractor, Screw 1/8" |
| J9522 | Extractor, Screw 3/16" |
| J9523 | Extractor, Screw 15/64" |
| J9524 | Extractor, Screw 5/16" |
| J9525 | Extractor, Screw 3/8" |
| J4759 | Extension, 1/4" DR 2" |
| J4761 | Extension, 1/4" DR 6" |
| J5260 | Extension, 3/8" DR 3" |
| J5262 | Extension, 3/8" DR 12" |
| J5460 | Extension, 1/2" DR 2-1/2" |
| J5461 | Extension, 1/2" DR 5" |
| J5463 | Extension, 1/2" DR 10" |
| J5661 | Extension, 3/4" DR 8" |
| J5663 | Extension, 3/4" DR 16" |
| J5696 | Box, Extra Heavy-Duty Set |
| 15-265 | Hacksaw, 3-7/8" |
| J1316PD | Hammer, Ball Pein 16 oz. |
| J1332PD | Hammer, Ball Pein 32 oz. |
| 57-532 | Hammer, Compo-Cast® 21 oz. |
| J5265 | Handle, Hinge 3/8" DR 8-1/2" |
| J5468 | Handle, Hinge 1/2" DR |
| J5668 | Handle, Hinge 3/4" DR 20" |
| J5280G | Handle, Speed 3/8" DR |
| J5480G | Handle, Speed 1/2" DR |
| J2108 | Holder, Punch and Chisel |
| 10-099 | Knife, Stanley® Classic 99® Retractable Blade Utility |
| J209G | Pliers, Diagonal Cutting with Grip 7-5/16" |
| J272G | Pliers, End Cutting High Leverage 8-1/4" |
| J268G | Pliers, Lineman's with Grip 8-5/8" |
| J291NC | Pliers, Locking StraightT 7" |
| J226G | Pliers, Needle-Nose with Cutter 6-5/8" |
| J278G | Pliers, Slip-Joint with Grip 8-1/16" |
| J260SG | Pliers, Tongue and Groove 10-3/16" with Grip |
| J265SG | Pliers, Tongue and Groove 16" with Grip |
| J298 | Pliers, Wire Strippers 8-1/4" |
| J413/8 | Punch, Center 3/8" |
| J471/4X3/32 | Punch, Pin 3/32" |





| Contents | Description |
|-----------------|---|
| J475/16X1/8 | Punch, Pin 1/8" |
| J473/8X3/16 | Punch, Pin 3/16" |
| J503/16 | Punch, Starting 1/16" |
| J505/16 | Punch, Starting 1/8" |
| J503/8 | Punch, Starting 3/16" |
| J4749 | Ratchet, 1/4" DR |
| J5249 | Ratchet, 3/8" DR |
| J5449 | Ratchet, 1/2" DR |
| J5649 | Ratchet, 3/4" DR |
| J2336 | Scrapers, Gasket and Carbon |
| J88393 | Screwdriver, Phillips® #0 |
| J88313 | Screwdriver, Phillips® #1 |
| J88324 | Screwdriver, Phillips® #2 |
| J88322 | Screwdriver, Phillips® #2 |
| J88336 | Screwdriver, Phillips® #3 |
| J88348 | Screwdriver, Phillips® #4 |
| J88102 | Screwdriver, Slotted Keystone, Square 1/4" x 2" |
| J88104 | Screwdriver, Slotted Keystone, Square 1/4" x 4" |
| J88106 | Screwdriver, Slotted Keystone, Square 1/4" x 6" |
| J88108 | Screwdriver, Slotted Keystone, Square 1/4" x 8" |
| J88112 | Screwdriver, Slotted Keystone, Square 1/4" x 12" |
| J88002 | Screwdriver, Slotted Keystone, Round 1/4" x 1-1/2" |
| J4982 | Hex Key, 7 PC Set |
| J380 | Pliers, 6 PC Retaining Ring Set with Replacement Tips |
| J303S | Ships, Aviation Straight |
| J4706 | Socket, 1/4" DR 3/16" 6 PT |
| J4707 | Socket, 1/4" DR 7/32" 6 PT |
| J4708 | Socket, 1/4" DR 1/4" 6 PT |
| J4709 | Socket, 1/4" DR 9/32" 6 PT |
| J4710 | Socket, 1/4" DR 5/16" 6 PT |
| J4712 | Socket, 1/4" DR 3/8" 6 PT |
| J4714 | Socket, 1/4" DR 7/16" 6 PT |
| J4716 | Socket, 1/4" DR 1/2" 6 PT |
| J4711 | Socket, 1/4" DR 11/32" 6 PT |
| J4718 | Socket, 1/4" DR 9/16" 6 PT |
| J5212 | Socket, 3/8" DR 3/8" 12 PT |
| J5214 | Socket, 3/8" DR 7/16" 12 PT |
| J5216 | Socket, 3/8" DR 1/2" 12 PT |
| J5218 | Socket, 3/8" DR 9/16" 12 PT |
| J5220 | Socket, 3/8" DR 5/8" 12 PT |
| J5222 | Socket, 3/8" DR 11/16" 12 PT |
| J5226 | Socket, 3/8" DR 13/16" 12 PT |
| J5224 | Socket, 3/8" DR 3/4" 12 PT |
| J5228 | Socket, 3/8" DR 7/8" 12 PT |
| J5564 | Socket, 3/4" DR 2" 12 PT |
| J5010 | Socket, 3/8" DR 5/16" 12 PT Deep |
| J5012 | Socket, 3/8" DR 3/8" 12 PT Deep |
| J5014 | Socket, 3/8" DR 7/16" 12 PT Deep |
| J5016 | Socket, 3/8" DR 1/2" 12 PT Deep |
| J5018 | Socket, 3/8" DR 9/16" 12 PT Deep |
| J5020 | Socket, 3/8" DR 5/8" 12 PT Deep |
| J5022 | Socket, 3/8" DR 11/16" 12 PT Deep |
| J5026 | Socket, 3/8" DR 13/16" 12 PT Deep |

| Contents | Description |
|-----------------|-----------------------------------|
| J5024 | Socket, 3/8" DR 3/4" 12 PT Deep |
| J5028 | Socket, 3/8" DR 7/8" 12 PT Deep |
| J5412 | Socket, 1/2" DR 3/8" 12 PT |
| J5414 | Socket, 1/2" DR 7/16" 12 PT |
| J5416 | Socket, 1/2" DR 1/2" 12 PT |
| J5418 | Socket, 1/2" DR 9/16" 12 PT |
| J5419 | Socket, 1/2" DR 19/32" 12 PT |
| J5420 | Socket, 1/2" DR 5/8" 12 PT |
| J5421 | Socket, 1/2" DR 21/32" 12 PT |
| J5422 | Socket, 1/2" DR 11/16" 12 PT |
| J5424 | Socket, 1/2" DR 3/4" 12 PT |
| J5425 | Socket, 1/2" DR 25/32" 12 PT |
| J5426 | Socket, 1/2" DR 13/16" 12 PT |
| J5428 | Socket, 1/2" DR 7/8" 12 PT |
| J5430 | Socket, 1/2" DR 15/16" 12 PT |
| J5431 | Socket, 1/2" DR 31/32" 12 PT |
| J5432 | Socket, 1/2" DR 1" 12 PT |
| J5434 | Socket, 1/2" DR 1-1/16" 12 PT |
| J5436 | Socket, 1/2" DR 1-1/8" 12 PT |
| J5438 | Socket, 1/2" DR 1-3/16" 12 PT |
| J5440 | Socket, 1/2" DR 1-1/4" 12 PT |
| J5528 | Socket, 3/4" DR 7/8" 12 PT |
| J5530 | Socket, 3/4" DR 15/16" 12 PT |
| J5532 | Socket, 3/4" DR 1" 12 PT |
| J5534 | Socket, 3/4" DR 1-1/16" 12 PT |
| J5548 | Socket, 3/4" DR 1-1/2" 12 PT |
| J5536 | Socket, 3/4" DR 1-1/8" 12 PT |
| J5558 | Socket, 3/4" DR 1-13/16" 12 PT |
| J5540 | Socket, 3/4" DR 1-1/4" 12 PT |
| J5542 | Socket, 3/4" DR 1-5/16" 12 PT |
| J5544 | Socket, 3/4" DR 1-3/8" 12 PT |
| J5546 | Socket, 3/4" DR 1-7/16" 12 PT |
| J5552 | Socket, 3/4" DR 1-5/8" 12 PT |
| J5556 | Socket, 3/4" DR 1-3/4" 12 PT |
| J5560 | Socket, 3/4" DR 1-7/8" 12 PT |
| J706 | Wrench, Adjustable 6" |
| J710 | Wrench, Adjustable 10" |
| J712 | Wrench, Adjustable 12" |
| J1210A | Wrench, Combination 5/16" 12 PT |
| J1212ASD | Wrench, Combination 3/8" 12 PT |
| J1214ASD | Wrench, Combination 7/16" 12 PT |
| J1216ASD | Wrench, Combination 1/2" 12 PT |
| J1218ASD | Wrench, Combination 9/16" 12 PT |
| J1220ASD | Wrench, Combination 5/8" 12 PT |
| J1222ASD | Wrench, Combination 11/16" 12 PT |
| J1224ASD | Wrench, Combination 3/4" 12 PT |
| J1226ASD | Wrench, Combination 13/16" 12 PT |
| J1228ASD | Wrench, Combination 7/8" 12 PT |
| J1230ASD | Wrench, Combination 15/16" 12 PT |
| J1232ASD | Wrench, Combination 1" 12 PT |
| J1234ASD | Wrench, Combination 1-1/16" 12 PT |
| J1236ASD | Wrench, Combination 1-1/8" 12 PT |
| J1240ASD | Wrench, Combination 1-1/4" 12 PT |
| J814HD | Wrench, Pipe Heavy-Duty 14" |

164 PC STARTER SET WITH ROLLER CABINET J442735-7RD

Product #: J99701



- › 164 Pieces.
- › 1/4", 3/8", 1/2", 3/4" Drive Tools.
- › Designed for fastener sizes 3/16" - 2".
- › Contains: 86 Sockets and Accessories, 19 Wrenches, 16 Striking and Struck Tools, 11 Pliers, 12 Screwdrivers, 20 Miscellaneous Tools.
- › Weight: 315.0 lbs.



Representative Image; Contents May Differ

METRIC

164 PC STARTER SET WITH ROLLER CABINET J442742-7RD

Product #: J99702



- › 164 Pieces.
- › 1/4", 3/8", 1/2", 3/4" Drive Tools.
- › Designed for fastener sizes 3/16" - 2".
- › Contains: 86 Sockets and Accessories, 19 Wrenches, 16 Striking and Struck Tools, 11 Pliers, 12 Screwdrivers, 20 Miscellaneous Tools.
- › Weight: 320.0 lbs.



Representative Image; Contents May Differ



148 PC STARTER MAINTENANCE TOOL SET

Product #: J99660

- ▶ 148 Pieces.
- ▶ 3/8" Drive Tools.
- ▶ Designed for fastener sizes 1/8" - 1".
- ▶ Tools only.
- ▶ Contains: 59 Sockets and Accessories, 41 Wrenches, 1 Striking and Struck Tools, 3 Pliers, 30 Screwdrivers, 14 Miscellaneous Tools.
- ▶ Weight: 45.0 lbs.

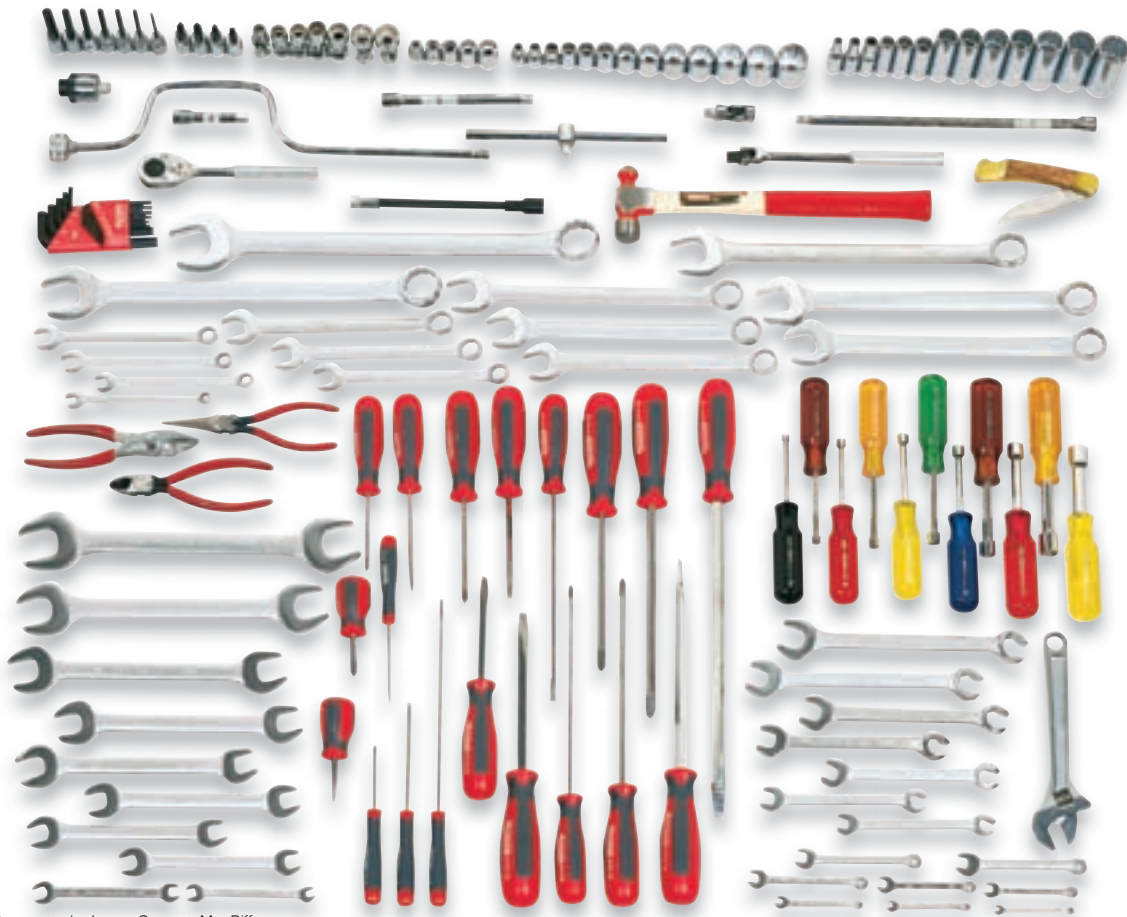

Representative Image; Contents May Differ

| Contents | Description |
|----------|----------------------------------|
| J5270A | Adapter, Universal Joint 3/8" DR |
| J5260 | Extension, 3/8" DR 3" |
| J5260-06 | Extension, 3/8" DR 6" |
| J5262 | Extension, 3/8" DR 12" |
| J5268 | Extension, Flex 3/8" DR 8" |
| J1308PD | Hammer, Ball Pein 8 oz. |
| J5265 | Handle, Hinge 3/8" DR 8-1/2" |
| J5285 | Handle, Sliding T 3/8" DR |
| J5280G | Handle, Speed 3/8" DR |
| J4980 | Hex Key, 13 PC Standard Set |
| J95218 | Knife, Folding Blade |
| J18545B | Knife, Lockback 5" |
| J9206 | Nut Driver, 3/16" |
| J9207 | Nut Driver, 7/32" |
| J9208 | Nut Driver, 1/4" |
| J9209 | Nut Driver, 9/32" |
| J9210 | Nut Driver, 5/16" |
| J9211 | Nut Driver, 11/32" |
| J9212 | Nut Driver, 3/8" |
| J9214 | Nut Driver 7/16" |

| Contents | Description |
|----------|--|
| J9216 | Nut Driver, 1/2" |
| J9218 | Nut Driver, 9/16" |
| J9220 | Nut Driver, 5/8" |
| J206G | Pliers, Diagonal Cutting with Grip 6-1/16" |
| J222G | Pliers, Needle-Nose Long Thin 6-1/16" |
| J276G | Pliers, Slip-Joint with Grip 6-9/16" |
| J5247 | Ratchet Adapter 3/8" DR 2-1/16" |
| J5249 | Ratchet, 3/8" DR |
| J88208 | Screwdriver, Slotted Cabinet, Round 1/8" x 8" |
| J88204 | Screwdriver, Slotted Cabinet, Round 1/8" x 4" |
| J88203 | Screwdriver, Slotted Cabinet, Round 1/8" x 3" |
| J88218 | Screwdriver, Slotted Cabinet, Round 3/16" x 8" |
| J88214 | Screwdriver, Slotted Cabinet, Round 3/16" x 4" |
| J88393 | Screwdriver, Phillips® #0 |
| J88318 | Screwdriver, Phillips® #1 |
| J88313 | Screwdriver, Phillips® #1 |
| J88328 | Screwdriver, Phillips® #2 |
| J88324 | Screwdriver, Phillips® #2 |
| J88322 | Screwdriver, Phillips® #2 |
| J88336 | Screwdriver, Phillips® #3 |

[CONTINUED ON NEXT PAGE]



148 PC STARTER MAINTENANCE TOOL SET (CONTINUED)

Product #: J99660



| Contents | Description |
|-----------|--|
| J88348 | Screwdriver, Phillips® #4 |
| J88102 | Screwdriver, Slotted Keystone, Square 1/4" x 2" |
| J88104 | Screwdriver, Slotted Keystone, Square 1/4" x 4" |
| J88106 | Screwdriver, Slotted Keystone, Square 1/4" x 6" |
| J88108 | Screwdriver, Slotted Keystone, Square 1/4" x 8" |
| J88112 | Screwdriver, Slotted Keystone, Square 1/4" x 12" |
| J88002 | Screwdriver, Slotted Keystone, Round 1/4" x 1-1/2" |
| J5208S | Socket, 3/8" DR 1/4" 8 PT |
| J5210S | Socket, 3/8" DR 5/16" 8 PT |
| J5212S | Socket, 3/8" DR 3/8" 8 PT |
| J5214S | Socket, 3/8" DR 7/16" 8 PT |
| J5216S | Socket, 3/8" DR 1/2" 8 PT |
| J5208 | Socket, 3/8" DR 1/4" 12 PT |
| J5210 | Socket, 3/8" DR 5/16" 12 PT |
| J5212 | Socket, 3/8" DR 3/8" 12 PT |
| J5214 | Socket, 3/8" DR 7/16" 12 PT |
| J5216 | Socket, 3/8" DR 1/2" 12 PT |
| J5218 | Socket, 3/8" DR 9/16" 12 PT |
| J5220 | Socket, 3/8" DR 5/8" 12 PT |
| J5222 | Socket, 3/8" DR 11/16" 12 PT |
| J5224 | Socket, 3/8" DR 3/4" 12 PT |
| J5226 | Socket, 3/8" DR 13/16" 12 PT |
| J5228 | Socket, 3/8" DR 7/8" 12 PT |
| J5230 | Socket, 3/8" DR 15/16" 12 PT |
| J5232 | Socket, 3/8" DR 1" 12 PT |
| J5008 | Socket, 3/8" DR 1/4" 12 PT Deep |
| J5010 | Socket, 3/8" DR 5/16" 12 PT Deep |
| J5012 | Socket, 3/8" DR 3/8" 12 PT Deep |
| J5014 | Socket, 3/8" DR 7/16" 12 PT Deep |
| J5016 | Socket, 3/8" DR 1/2" 12 PT Deep |
| J5018 | Socket, 3/8" DR 9/16" 12 PT Deep |
| J5020 | Socket, 3/8" DR 5/8" 12 PT Deep |
| J5022 | Socket, 3/8" DR 11/16" 12 PT Deep |
| J5024 | Socket, 3/8" DR 3/4" 12 PT Deep |
| J5026 | Socket, 3/8" DR 13/16" 12 PT Deep |
| J5028 | Socket, 3/8" DR 7/8" 12 PT Deep |
| J5030 | Socket, 3/8" DR 15/16" 12 PT Deep |
| J5032 | Socket, 3/8" DR 1" 12 PT Deep |
| J5241 | Socket, Bit 3/8" DR #2 Phillips® |
| J5242 | Socket, Bit 3/8" DR #3 Phillips® |
| J5243 | Socket, Bit 3/8" DR #4 Phillips® |
| J5246 | Socket, Bit 3/8" DR Slotted |
| J49901/8 | Socket, Hex Bit 3/8" DR 1/8" |
| J49905/32 | Socket, Hex Bit 3/8" DR 5/32" |
| J49903/16 | Socket, Hex Bit 3/8" DR 3/16" |
| J49907/32 | Socket, Hex Bit 3/8" DR 7/32" |
| J49901/4 | Socket, Hex Bit 3/8" DR 1/4" |
| J49905/16 | Socket, Hex Bit 3/8" DR 5/16" |
| J49903/8 | Socket, Hex Bit 3/8" DR 3/8" |

| Contents | Description |
|----------|---|
| J5273A | Socket, Universal 3/8" DR 3/8" 12 PT |
| J5274A | Socket, Universal 3/8" DR 7/16" 12 PT |
| J5275A | Socket, Universal 3/8" DR 1/2" 12 PT |
| J5276A | Socket, Universal 3/8" DR 9/16" 12 PT |
| J5277A | Socket, Universal 3/8" DR 5/8" 12 PT |
| J5278A | Socket, Universal 3/8" DR 11/16" 12 PT |
| J5279A | Socket, Universal 3/8" DR 3/4" 12 PT |
| J708 | Wrench, Adjustable 8" |
| J1210A | Wrench, Combination 5/16" 12 PT |
| J1212ASD | Wrench, Combination 3/8" 12 PT |
| J1214ASD | Wrench, Combination 7/16" 12 PT |
| J1216ASD | Wrench, Combination 1/2" 12 PT |
| J1218ASD | Wrench, Combination 9/16" 12 PT |
| J1220ASD | Wrench, Combination 5/8" 12 PT |
| J1222ASD | Wrench, Combination 11/16" 12 PT |
| J1224ASD | Wrench, Combination 3/4" 12 PT |
| J1226ASD | Wrench, Combination 13/16" 12 PT |
| J1228ASD | Wrench, Combination 7/8" 12 PT |
| J1230ASD | Wrench, Combination 15/16" 12 PT |
| J1232ASD | Wrench, Combination 1" 12 PT |
| J1234ASD | Wrench, Combination 1-1/16" 12 PT |
| J1236ASD | Wrench, Combination 1-1/8" 12 PT |
| J1240ASD | Wrench, Combination 1-1/4" 12 PT |
| J1204EF | Wrench, Combination 1/8" 6 PT Short |
| J1205EF | Wrench, Combination 5/32" 6 PT Short |
| J1206EF | Wrench, Combination 3/16" 6 PT Short |
| J1208EF | Wrench, Combination 1/4" 6 PT Short |
| J1209EF | Wrench, Combination 9/32" 6 PT Short |
| J1210EF | Wrench, Combination 5/16" 6 PT Short |
| J1211EF | Wrench, Combination 11/32" 6 PT Short |
| J1212EF | Wrench, Combination 3/8" 6 PT Short |
| J3751 | Wrench, Flare Nut Combination 3/8" 6 PT |
| J3752 | Wrench, Flare Nut Combination 7/16" 6 PT |
| J3753 | Wrench, Flare Nut Combination 1/2" 6 PT |
| J3754 | Wrench, Flare Nut Combination 9/16" 6 PT |
| J3755 | Wrench, Flare Nut Combination 5/8" 6 PT |
| J3756 | Wrench, Flare Nut Combination 11/16" 6 PT |
| J3757 | Wrench, Flare Nut Combination 3/4" 6 PT |
| J3018 | Wrench, Open End 1/4" x 5/16" |
| J3020 | Wrench, Open End 3/8" x 5/16" |
| J3025 | Wrench, Open End 7/16" x 1/2" |
| J3026 | Wrench, Open End 1/2" x 9/16" |
| J3030 | Wrench, Open End 9/16" x 5/8" |
| J3031 | Wrench, Open End 5/8" x 3/4" |
| J3035 | Wrench, Open End 11/16" x 3/4" |
| J3040 | Wrench, Open End 13/16" x 7/8" |
| J3045 | Wrench, Open End 15/16" x 1" |
| J3050 | Wrench, Open End 1-1/16" x 1-1/8" |



148 PC STARTER MAINTENANCE TOOL SET WITH TOP CHEST J442719-12RD-D

Product #: J99661



- › 148 Pieces.
- › 3/8" Drive Tools.
- › Designed for fastener sizes 1/8" - 1".
- › Contains: 59 Sockets and Accessories, 41 Wrenches, 1 Striking and Struck Tool, 3 Pliers, 19 Screwdrivers, 25 Miscellaneous Tools.
- › Weight: 201.0 lbs.



Representative Image; Contents May Differ

148 PC STARTER MAINTENANCE TOOL SET WITH ROLLER CABINET J442742-7RD

Product #: J99662



- › 148 Pieces.
- › 3/8" Drive Tools.
- › Designed for fastener sizes 1/8" - 1".
- › Contains: 59 Sockets and Accessories, 41 Wrenches, 1 Striking and Struck Tool, 3 Pliers, 19 Screwdrivers, 25 Miscellaneous Tools.
- › Weight: 225.0 lbs.



Representative Image; Contents May Differ



126 PC STARTER MAINTENANCE SET

Product #: J99810



- › 126 Pieces.
- › 1/4", 3/8" Drive Tools.
- › Designed for fastener sizes 1/16" - 1".
- › Tools Only.
- › Contains: 107 Sockets and Accessories, 16 Wrenches, 1 Striking and Struck Tools, 2 Pliers.
- › Weight: 34.0 lbs.



Representative Image; Contents May Differ

| Contents | Description |
|----------|----------------------------------|
| J4770A | Adapter, Universal Joint 1/4" DR |
| J5270A | Adapter, Universal Joint 3/8" DR |
| J4769 | Driver, 1/4" DR |
| J4759 | Extension, 1/4" DR 2" |
| J4760 | Extension, 1/4" DR 3" |

| Contents | Description |
|----------|--------------------------------|
| J4761 | Extension, 1/4" DR 6" |
| J5260 | Extension, 3/8" DR 3" |
| J5260-06 | Extension, 3/8" DR 6" |
| J5262 | Extension, 3/8" DR 12" |
| J4765 | Extension, Flex 1/4" DR 6-1/4" |





| Contents | Description |
|----------|--------------------------------------|
| J5260W | Extension, Wobble 3/8" DR 3" |
| J1308PD | Hammer, Ball Pein 8 oz. |
| J4766 | Handle, Hinge 1/4" DR 5-3/4" |
| J5265 | Handle, Hinge 3/8" DR 8-1/2" |
| J4785 | Handle, Sliding T 1/4" DR |
| J5285 | Handle, Sliding T 3/8" DR |
| J5280G | Handle, Speed 3/8" DR |
| J291NC | Pliers, Locking Straight 7" |
| J276G | Pliers, Slip-Joint with Grip 6-9/16" |
| J4749 | Ratchet, 1/4" DR |
| J5249 | Ratchet, 3/8" DR |
| J5247 | Ratchet, Adapter 3/8" DR 5/16" |
| J4706 | Socket, 1/4" DR 3/16" 6 PT |
| J4707 | Socket, 1/4" DR 7/32" 6 PT |
| J4708 | Socket, 1/4" DR 1/4" 6 PT |
| J4709 | Socket, 1/4" DR 9/32" 6 PT |
| J4710 | Socket, 1/4" DR 5/16" 6 PT |
| J4711 | Socket, 1/4" DR 11/32" 6 PT |
| J4712 | Socket, 1/4" DR 3/8" 6 PT |
| J4714 | Socket, 1/4" DR 7/16" 6 PT |
| J4716 | Socket, 1/4" DR 1/2" 6 PT |
| J4718 | Socket, 1/4" DR 9/16" 6 PT |
| J4706L | Socket, 1/4" DR 3/16" 6 PT Deep |
| J4707L | Socket, 1/4" DR 7/32" 6 PT Deep |
| J4708L | Socket, 1/4" DR 1/4" 6 PT Deep |
| J4709L | Socket, 1/4" DR 9/32" 6 PT Deep |
| J4710L | Socket, 1/4" DR 5/16" 6 PT Deep |
| J4711L | Socket, 1/4" DR 11/32" 6 PT Deep |
| J4712L | Socket, 1/4" DR 3/8" 6 PT Deep |
| J4714L | Socket, 1/4" DR 7/16" 6 PT Deep |
| J4716L | Socket, 1/4" DR 1/2" 6 PT Deep |
| J4718L | Socket, 1/4" DR 9/16" 6 PT Deep |
| J4708S | Socket, 1/4" DR 1/4" 8 PT |
| J4710S | Socket, 1/4" DR 5/16" 8 PT |
| J4712S | Socket, 1/4" DR 3/8" 8 PT |
| J5208S | Socket, 3/8" DR 1/4" 8 PT |
| J5210S | Socket, 3/8" DR 5/16" 8 PT |
| J5212S | Socket, 3/8" DR 3/8" 8 PT |
| J5214S | Socket, 3/8" DR 7/16" 8 PT |
| J5216S | Socket, 3/8" DR 1/2" 8 PT |
| J5208 | Socket, 3/8" DR 1/4" 12 PT |
| J5210 | Socket, 3/8" DR 5/16" 12 PT |
| J5212 | Socket, 3/8" DR 3/8" 12 PT |
| J5214 | Socket, 3/8" DR 7/16" 12 PT |
| J5216 | Socket, 3/8" DR 1/2" 12 PT |
| J5218 | Socket, 3/8" DR 9/16" 12 PT |
| J5220 | Socket, 3/8" DR 5/8" 12 PT |
| J5222 | Socket, 3/8" DR 11/16" 12 PT |
| J5224 | Socket, 3/8" DR 3/4" 12 PT |
| J5226 | Socket, 3/8" DR 13/16" 12 PT |
| J5228 | Socket, 3/8" DR 7/8" 12 PT |
| J5230 | Socket, 3/8" DR 15/16" 12 PT |
| J5232 | Socket, 3/8" DR 1" 12 PT |
| J5008 | Socket, 3/8" DR 1/4" 12 PT Deep |
| J5010 | Socket, 3/8" DR 5/16" 12 PT Deep |
| J5012 | Socket, 3/8" DR 3/8" 12 PT Deep |
| J5014 | Socket, 3/8" DR 7/16" 12 PT Deep |
| J5016 | Socket, 3/8" DR 1/2" 12 PT Deep |

| Contents | Description |
|-----------|---|
| J5018 | Socket, 3/8" DR 9/16" 12 PT Deep |
| J5020 | Socket, 3/8" DR 5/8" 12 PT Deep |
| J5022 | Socket, 3/8" DR 11/16" 12 PT Deep |
| J5024 | Socket, 3/8" DR 3/4" 12 PT Deep |
| J5026 | Socket, 3/8" DR 13/16" 12 PT Deep |
| J5028 | Socket, 3/8" DR 7/8" 12 PT Deep |
| J5030 | Socket, 3/8" DR 15/16" 12 PT Deep |
| J5032 | Socket, 3/8" DR 1" 12 PT Deep |
| J4737 | Socket, Bit 1/4" DR #1 Phillips® |
| J4738 | Socket, Bit 1/4" DR #2 Phillips® |
| J5241 | Socket, Bit 3/8" DR #2 Phillips® |
| J5242 | Socket, Bit 3/8" DR #3 Phillips® |
| J5243 | Socket, Bit 3/8" DR #4 Phillips® |
| J4743 | Socket, Bit 1/4" DR Slotted 1/4" 1-3/16" |
| J4744 | Socket, Bit 1/4" DR Slotted 3/16" |
| J4745 | Socket, Bit 1/4" DR Slotted 1/4" 1-13/64" |
| J5246 | Socket, Bit 3/8" DR Slotted |
| J47701/16 | Socket, Hex Bit 1/4" DR 1/16" |
| J47705/64 | Socket, Hex Bit 1/4" DR 5/64" |
| J47703/32 | Socket, Hex Bit 1/4" DR 3/32" |
| J47707/64 | Socket, Hex Bit 1/4" DR 7/64" |
| J47701/8 | Socket, Hex Bit 1/4" DR 1/8" |
| J47709/64 | Socket, Hex Bit 1/4" DR 9/64" |
| J47705/32 | Socket, Hex Bit 1/4" DR 5/32" |
| J47703/16 | Socket, Hex Bit 1/4" DR 3/16" |
| J47707/32 | Socket, Hex Bit 1/4" DR 7/32" |
| J47701/4 | Socket, Hex Bit 1/4" DR 1/4" |
| J47705/16 | Socket, Hex Bit 1/4" DR 5/16" |
| J49901/8 | Socket, Hex Bit 3/8" DR 1/8" |
| J49905/32 | Socket, Hex Bit 3/8" DR 5/32" |
| J49903/16 | Socket, Hex Bit 3/8" DR 3/16" |
| J49907/32 | Socket, Hex Bit 3/8" DR 7/32" |
| J49901/4 | Socket, Hex Bit 3/8" DR 1/4" |
| J49905/16 | Socket, Hex Bit 3/8" DR 5/16" |
| J49903/8 | Socket, Hex Bit 3/8" DR 3/8" |
| J5273A | Socket, Universal 3/8" DR 3/8" 12 PT |
| J5274A | Socket, Universal 3/8" DR 7/16" 12 PT |
| J5275A | Socket, Universal 3/8" DR 1/2" 12 PT |
| J5276A | Socket, Universal 3/8" DR 9/16" 12 PT |
| J5277A | Socket, Universal 3/8" DR 5/8" 12 PT |
| J5278A | Socket, Universal 3/8" DR 11/16" 12 PT |
| J5279A | Socket, Universal 3/8" DR 3/4" 12 PT |
| J706 | Wrench, Adjustable 6" |
| J1210A | Wrench, Combination 5/16" 12 PT |
| J1212ASD | Wrench, Combination 3/8" 12 PT |
| J1214ASD | Wrench, Combination 7/16" 12 PT |
| J1216ASD | Wrench, Combination 1/2" 12 PT |
| J1218ASD | Wrench, Combination 9/16" 12 PT |
| J1220ASD | Wrench, Combination 5/8" 12 PT |
| J1222ASD | Wrench, Combination 11/16" 12 PT |
| J1224ASD | Wrench, Combination 3/4" 12 PT |
| J1226ASD | Wrench, Combination 13/16" 12 PT |
| J1228ASD | Wrench, Combination 7/8" 12 PT |
| J1230ASD | Wrench, Combination 15/16" 12 PT |
| J1232ASD | Wrench, Combination 1" 12 PT |
| J1234ASD | Wrench, Combination 1-1/16" 12 PT |
| J1236ASD | Wrench, Combination 1-1/8" 12 PT |
| J1240ASD | Wrench, Combination 1-1/4" 12 PT |

126 PC STARTER MAINTENANCE SET WITH TOP CHEST J442719-10RD-D

Product #: **J99811**

- › 126 Pieces.
- › 1/4", 3/8" Drive Tools.
- › Designed for fastener sizes 1/16" - 1".
- › Contains: 107 Sockets and Accessories, 16 Wrenches, 1 Striking and Struck Tool, 2 Pliers.
- › Weight: 176.0 lbs.



Representative Image; Contents May Differ



126 PC STARTER MAINTENANCE SET WITH TOP CHEST J442719-8RD

Product #: **J99812**

- › 126 Pieces.
- › 1/4", 3/8" Drive Tools.
- › Designed for fastener sizes 1/16" - 1".
- › Contains: 107 Sockets and Accessories, 16 Wrenches, 1 Striking and Struck Tool, 2 Pliers.
- › Weight: 174.0 lbs.



Representative Image; Contents May Differ



98 PC STARTER MAINTENANCE TOOL SET

Product #: J99480



- ▶ 98 Pieces.
- ▶ 3/8" Drive Tools.
- ▶ Designed for fastener sizes 1/4" - 1-1/4".
- ▶ Tools only.
- ▶ Contains: 33 Sockets and Accessories, 21 Wrenches, 13 Striking and Struck Tools, 5 Pliers, 12 Screwdrivers, 14 Miscellaneous Tools.
- ▶ Weight: 40.0 lbs.



Representative Image; Contents May Differ

| Contents | Description |
|----------|--|
| J5270A | Adapter, Universal Joint 3/8" DR |
| J725/16 | Chisel, Cape 13/64" |
| J86A1/4 | Chisel, Cold 5/16" |
| J86A3/8 | Chisel, Cold 7/16" |
| J86A7/16 | Chisel, Cold 1/2" |
| J765/16 | Chisel, Diamond PT 3/16" |
| J5260 | Extension, 3/8" DR 3" |
| J5260-06 | Extension, 3/8" DR 6" |
| J5262 | Extension, 3/8" DR 12" |
| 15-265 | Hacksaw, 3-7/8" |
| J5265 | Handle, Hinge 3/8" DR 8-1/2" |
| J5280G | Handle, Speed 3/8" DR |
| J4980 | Hex Key, 13 PC Standard Set |
| J2108 | Holder, Punch and Chisel |
| J206G | Pliers, Diagonal Cutting with Grip 6-1/16" |
| J272G | Pliers, End Cutting High Leverage 8-1/4" |

| Contents | Description |
|-------------|--------------------------------------|
| J291NC | Pliers, Locking Straight 7" |
| J278G | Pliers, Slip-Joint with Grip 8-1/16" |
| J413/8 | Punch, Center 3/8" |
| J475/16X1/8 | Punch, Pin 1/8" |
| J471/4X3/32 | Punch, Pin 3/32" |
| J473/8X3/16 | Punch, Pin 3/16" |
| J503/16 | Punch, Starting 1/16" |
| J505/16 | Punch, Starting 1/8" |
| J503/8 | Punch, Starting 3/16" |
| J5249 | Ratchet, 3/8" DR |
| J88393 | Screwdriver, Phillips® #0 |
| J88313 | Screwdriver, Phillips® #1 |
| J88324 | Screwdriver, Phillips® #2 |
| J88322 | Screwdriver, Phillips® #2 |
| J88336 | Screwdriver, Phillips® #3 |
| J88348 | Screwdriver, Phillips® #4 |

(CONTINUED ON NEXT PAGE)





98 PC STARTER MAINTENANCE TOOL SET (CONTINUED)

Product #: **J99480**



| Contents | Description | Contents | Description |
|----------|--|----------|---------------------------------------|
| J88102 | Screwdriver, Slotted Keystone, Square 1/4" x 2" | J5028 | Socket, 3/8" DR 7/8" 12 PT Deep |
| J88104 | Screwdriver, Slotted Keystone, Square 1/4" x 4" | J5274A | Socket, Universal 3/8" DR 7/16" 12 PT |
| J88106 | Screwdriver, Slotted Keystone, Square 1/4" x 6" | J5275A | Socket, Universal 3/8" DR 1/2" 12 PT |
| J88108 | Screwdriver, Slotted Keystone, Square 1/4" x 8" | J5276A | Socket, Universal 3/8" DR 9/16" 12 PT |
| J88112 | Screwdriver, Slotted Keystone, Square 1/4" x 12" | J5277A | Socket, Universal 3/8" DR 5/8" 12 PT |
| J88002 | Screwdriver, Slotted Keystone, Round 1/4" x 1-1/2" | J5279A | Socket, Universal 3/8" DR 3/4" 12 PT |
| J303S | Snips, Aviation Straight | J706 | Wrench, Adjustable 6" |
| J5208S | Socket, 3/8" DR 1/4" 8 PT | J1210A | Wrench, Combination 5/16" 12 PT |
| J5210S | Socket, 3/8" DR 5/16" 8 PT | J1212ASD | Wrench, Combination 3/8" 12 PT |
| J5212S | Socket, 3/8" DR 3/8" 8 PT | J1214ASD | Wrench, Combination 7/16" 12 PT |
| J5212 | Socket, 3/8" DR 3/8" 12 PT | J1216ASD | Wrench, Combination 1/2" 12 PT |
| J5214 | Socket, 3/8" DR 7/16" 12 PT | J1218ASD | Wrench, Combination 9/16" 12 PT |
| J5216 | Socket, 3/8" DR 1/2" 12 PT | J1220ASD | Wrench, Combination 5/8" 12 PT |
| J5218 | Socket, 3/8" DR 9/16" 12 PT | J1222ASD | Wrench, Combination 11/16" 12 PT |
| J5220 | Socket, 3/8" DR 5/8" 12 PT | J1224ASD | Wrench, Combination 3/4" 12 PT |
| J5222 | Socket, 3/8" DR 11/16" 12 PT | J1226ASD | Wrench, Combination 13/16" 12 PT |
| J5224 | Socket, 3/8" DR 3/4" 12 PT | J1228ASD | Wrench, Combination 7/8" 12 PT |
| J5226 | Socket, 3/8" DR 13/16" 12 PT | J1230ASD | Wrench, Combination 15/16" 12 PT |
| J5228 | Socket, 3/8" DR 7/8" 12 PT | J1232ASD | Wrench, Combination 1" 12 PT |
| J5012 | Socket, 3/8" DR 3/8" 12 PT Deep | J1234ASD | Wrench, Combination 1-1/16" 12 PT |
| J5014 | Socket, 3/8" DR 7/16" 12 PT Deep | J1236ASD | Wrench, Combination 1-1/8" 12 PT |
| J5016 | Socket, 3/8" DR 1/2" 12 PT Deep | J1240ASD | Wrench, Combination 1-1/4" 12 PT |
| J5018 | Socket, 3/8" DR 9/16" 12 PT Deep | J3021 | Wrench, Open End 3/8" x 7/16" |
| J5020 | Socket, 3/8" DR 5/8" 12 PT Deep | J3026 | Wrench, Open End 1/2" x 9/16" |
| J5022 | Socket, 3/8" DR 11/16" 12 PT Deep | J3030 | Wrench, Open End 9/16" x 5/8" |
| J5024 | Socket, 3/8" DR 3/4" 12 PT Deep | J3035 | Wrench, Open End 11/16" x 3/4" |
| J5026 | Socket, 3/8" DR 13/16" 12 PT Deep | J3040 | Wrench, Open End 13/16" x 7/8" |



78 PC STARTER SET

Product #: J99300

- › 78 Pieces.
 - › 1/2" Drive Tools.
 - › Designed for fastener sizes 5/16" - 1-1/4".
 - › Tools only.
- › Contains: 30 Sockets and Accessories, 17 Wrenches, 10 Striking and Struck Tools, 5 Pliers, 7 Screwdrivers, 9 Miscellaneous Tools.
 - › Weight: 46.0 lbs.



Representative Image; Contents May Differ

| Contents | Description |
|-------------|--|
| J86A5/16 | Chisel, Cold 3/8" |
| J86A7/16 | Chisel, Cold 1/2" |
| J86A5/8 | Chisel, Cold 3/4" |
| J5461 | Extension, 1/2" DR 5" |
| J5463 | Extension, 1/2" DR 10" |
| J1316PD | Hammer, Ball Pein 16 oz. |
| 57-532 | Hammer, Compo-Cast® 21 oz. |
| J5467 | Handle, Hinge 1/2" DR 15-3/4" |
| J4978 | Hex Key, 9 PC Folding Set |
| J209G | Pliers, Diagonal Cutting with Grip 7-5/16" |
| J291NC | Pliers, Locking Straight 7" |
| J226G | Pliers, Needle-Nose with Cutter 6-5/8" |
| J278G | Pliers, Slip-Joint with Grip 8-1/16" |
| J260SG | Pliers, Tongue and Groove 10-3/16" with Grip |
| J411/2 | Punch, Center 1/2" |
| J413/8 | Punch, Center 3/8" |
| J961/2 | Punch, Drift 1/4" |
| J475/16X1/8 | Punch, Pin 1/8" |
| J473/8X3/16 | Punch, Pin 3/16" |
| J5449 | Ratchet, 1/2" DR |
| J88313 | Screwdriver, Phillips® #1 |
| J88324 | Screwdriver, Phillips® #2 |
| J88336 | Screwdriver, Phillips® #3 |

| Contents | Description |
|----------|--|
| J88102 | Screwdriver, Slotted Keystone, Square 1/4" x 2" |
| J88106 | Screwdriver, Slotted Keystone, Square 1/4" x 6" |
| J88108 | Screwdriver, Slotted Keystone, Square 1/4" x 8" |
| J88002 | Screwdriver, Slotted Keystone, Round 1/4" x 1-1/2" |
| J5412 | Socket, 1/2" DR 3/8" 12 PT |
| J5414 | Socket, 1/2" DR 7/16" 12 PT |
| J5416 | Socket, 1/2" DR 1/2" 12 PT |
| J5418 | Socket, 1/2" DR 9/16" 12 PT |
| J5420 | Socket, 1/2" DR 5/8" 12 PT |
| J5422 | Socket, 1/2" DR 11/16" 12 PT |
| J5424 | Socket, 1/2" DR 3/4" 12 PT |
| J5426 | Socket, 1/2" DR 13/16" 12 PT |
| J5428 | Socket, 1/2" DR 7/8" 12 PT |
| J5430 | Socket, 1/2" DR 15/16" 12 PT |
| J5432 | Socket, 1/2" DR 1" 12 PT |
| J5434 | Socket, 1/2" DR 1-1/16" 12 PT |
| J5436 | Socket, 1/2" DR 1-1/8" 12 PT |
| J5440 | Socket, 1/2" DR 1-1/4" 12 PT |
| J5316 | Socket, 1/2" DR 1/2" 12 PT Deep |
| J5318 | Socket, 1/2" DR 9/16" 12 PT Deep |
| J5320 | Socket, 1/2" DR 5/8" 12 PT Deep |
| J5322 | Socket, 1/2" DR 11/16" 12 PT Deep |
| J5324 | Socket, 1/2" DR 3/4" 12 PT Deep |

(CONTINUED ON NEXT PAGE)

78 PC STARTER SET (CONTINUED)

Product #: **J99300**



| Contents | Description |
|----------|------------------------------------|
| J5326 | Socket, 1/2" DR 13/16" 12 PT Deep |
| J5328 | Socket, 1/2" DR 7/8" 12 PT Deep |
| J5330 | Socket, 1/2" DR 15/16" 12 PT Deep |
| J5332 | Socket, 1/2" DR 1" 12 PT Deep |
| J5334 | Socket, 1/2" DR 1-1/16" 12 PT Deep |
| J5336 | Socket, 1/2" DR 1-1/8" 12 PT Deep |
| J5340 | Socket, 1/2" DR 1-1/4" 12 PT Deep |
| J708 | Wrench, Adjustable 8" |
| J712 | Wrench, Adjustable 12" |
| J1210A | Wrench, Combination 5/16" 12 PT |
| J1212ASD | Wrench, Combination 3/8" 12 PT |
| J1214ASD | Wrench, Combination 7/16" 12 PT |

| Contents | Description |
|----------|-----------------------------------|
| J1216ASD | Wrench, Combination 1/2" 12 PT |
| J1218ASD | Wrench, Combination 9/16" 12 PT |
| J1220ASD | Wrench, Combination 5/8" 12 PT |
| J1222ASD | Wrench, Combination 11/16" 12 PT |
| J1224ASD | Wrench, Combination 3/4" 12 PT |
| J1226ASD | Wrench, Combination 13/16" 12 PT |
| J1228ASD | Wrench, Combination 7/8" 12 PT |
| J1230ASD | Wrench, Combination 15/16" 12 PT |
| J1232ASD | Wrench, Combination 1" 12 PT |
| J1234ASD | Wrench, Combination 1-1/16" 12 PT |
| J1236ASD | Wrench, Combination 1-1/8" 12 PT |
| J1240ASD | Wrench, Combination 1-1/4" 12 PT |

78 PC STARTER SET WITH TOOL BOX J9969-NA

Product #: **J99301**



- › 78 Pieces.
- › 1/2" Drive Tools.
- › Designed for fastener sizes 5/16" - 1-1/4".
- › Contains: 30 Sockets and Accessories, 17 Wrenches, 10 Striking and Struck Tools, 5 Pliers, 7 Screwdrivers, 9 Miscellaneous Tools.
- › Weight: 55.0 lbs.



Representative Image; Contents May Differ



62 PC STARTER SET

Product #: J99200

- › 62 Pieces.
 - › 3/8" Drive Tools.
 - › Designed for fastener sizes 3/8" - 7/8".
 - › Tools only.
- › Contains: 22 Sockets and Accessories, 11 Wrenches, 10 Striking and Struck Tools, 5 Pliers, 5 Screwdrivers, 9 Miscellaneous Tools.
 - › Weight: 23.0 lbs.



Representative Image; Contents May Differ

| Contents | Description |
|-------------|--|
| J5270A | Adapter, Universal Joint 3/8" DR |
| J86A5/16 | Chisel, Cold 3/8" |
| J86A7/16 | Chisel, Cold 1/2" |
| J86A5/8 | Chisel, Cold 3/4" |
| J5260 | Extension, 3/8" DR 3" |
| J5260-06 | Extension, 3/8" DR 6" |
| J1316PD | Hammer, Ball Pein 16 oz. |
| 57-530 | Hammer, Compo-Cast® 10 oz. |
| J209G | Pliers, Diagonal Cutting with Grip 7-5/16" |
| J291NC | Pliers, Locking Straight 7" |
| J226G | Pliers, Needle-Nose with Cutter 6-5/8" |
| J278G | Pliers, Slip-Joint with Grip 8-1/16" |
| J260SG | Pliers, Tongue and Groove 10-3/16" with Grip |
| J411/2 | Punch, Center 1/2" |
| J413/8 | Punch, Center 3/8" |
| J963/8 | Punch, Drift 3/16" |
| J475/16X1/8 | Punch, Pin 1/8" |
| J473/8X3/16 | Punch, Pin 3/16" |

| Contents | Description |
|----------|---|
| J5249 | Ratchet, 3/8" DR |
| J88313 | Screwdriver, Phillips® #1 |
| J88324 | Screwdriver, Phillips® #2 |
| J88102 | Screwdriver, Slotted Keystone, Square 1/4" x 2" |
| J88106 | Screwdriver, Slotted Keystone, Square 1/4" x 4" |
| J88108 | Screwdriver, Slotted Keystone, Square 1/4" x 8" |
| J4978 | Hey Key, 9 PC Folding Set |
| J5212H | Socket, 3/8" DR 3/8" 6 PT |
| J5214H | Socket, 3/8" DR 7/16" 6 PT |
| J5216H | Socket, 3/8" DR 1/2" 6 PT |
| J5218H | Socket, 3/8" DR 9/16" 6 PT |
| J5220H | Socket, 3/8" DR 5/8" 6 PT |
| J5222H | Socket, 3/8" DR 11/16" 6 PT |
| J5224H | Socket, 3/8" DR 3/4" 6 PT |
| J5226H | Socket, 3/8" DR 13/16" 6 PT |
| J5228H | Socket, 3/8" DR 7/8" 6 PT |
| J5012H | Socket, 3/8" DR 3/8" 6 PT Deep |
| J5014H | Socket, 3/8" DR 7/16" 6 PT Deep |

[CONTINUED ON NEXT PAGE]



62 PC STARTER SET (CONTINUED)

Product #: **J99200**



| Contents | Description |
|----------|----------------------------------|
| J5016H | Socket, 3/8" DR 1/2" 6 PT Deep |
| J5018H | Socket, 3/8" DR 9/16" 6 PT Deep |
| J5020H | Socket, 3/8" DR 5/8" 6 PT Deep |
| J5022H | Socket, 3/8" DR 11/16" 6 PT Deep |
| J5024H | Socket, 3/8" DR 3/4" 6 PT Deep |
| J5026H | Socket, 3/8" DR 13/16" 6 PT Deep |
| J5028H | Socket, 3/8" DR 7/8" 6 PT Deep |
| J706 | Wrench, Adjustable 6" |
| J710 | Wrench, Adjustable 10" |

| Contents | Description |
|----------|----------------------------------|
| J1212ASD | Wrench, Combination 3/8" 12 PT |
| J1214ASD | Wrench, Combination 7/16" 12 PT |
| J1216ASD | Wrench, Combination 1/2" 12 PT |
| J1218ASD | Wrench, Combination 9/16" 12 PT |
| J1220ASD | Wrench, Combination 5/8" 12 PT |
| J1222ASD | Wrench, Combination 11/16" 12 PT |
| J1224ASD | Wrench, Combination 3/4" 12 PT |
| J1226ASD | Wrench, Combination 13/16" 12 PT |
| J1228ASD | Wrench, Combination 7/8" 12 PT |

62 PC STARTER SET WITH TOOL BOX J9975-NA

Product #: **J99201**



- › 62 Pieces.
- › 3/8" Drive Tools.
- › Designed for fastener sizes 3/8" - 7/8".
- › Contains: 22 Sockets and Accessories, 11 Wrenches, 10 Striking and Struck Tools, 5 Pliers, 5 Screwdrivers, 9 Miscellaneous Tools.
- › Weight: 35.0 lbs.



Representative Image; Contents May Differ



99 PC METRIC STARTER SET

METRIC



Product #: J99420

- › 99 Pieces.
- › 3/8", 1/2" Drive Tools.
- › Designed for fastener sizes 6 mm - 26 mm.
- › Tools only.
- › Contains: 42 Sockets and Accessories, 17 Wrenches, 15 Striking and Struck Tools, 6 Pliers, 8 Screwdrivers, 11 Miscellaneous Tools.
- › Weight: 44.0 lbs.



Representative Image; Contents May Differ

| Contents | Description |
|-------------|--|
| J5496-NA | Box, 19" Set |
| J5270A | Adapter, Universal Joint 3/8" DR |
| J5470A | Adapter, Universal Joint 1/2" DR |
| J725/16 | Chisel, Cape 13/64" |
| J86A1/4 | Chisel, Cold 5/16" |
| J86A3/8 | Chisel, Cold 7/16" |
| J86A7/16 | Chisel, Cold 1/2" |
| J765/16 | Chisel, Diamond PT 3/16" |
| J5260 | Extension, 3/8" DR 3" |
| J5262 | Extension, 3/8" DR 12" |
| J5461 | Extension, 1/2" DR 5" |
| J5463 | Extension, 1/2" DR 10" |
| 15-265 | Hacksaw, 3-7/8" |
| J1316PD | Hammer, Ball Pein 16 oz. |
| 57-532 | Hammer, Compo-Cast® 21 oz. |
| J5468 | Handle, Hinge 1/2" DR |
| J5265 | Handle, Hinge 3/8" DR 8-1/2" |
| J5280G | Handle, Speed 3/8" DR |
| J4984 | Hex Key, 9 PC Metric Set |
| J2108 | Holder, Punch and Chisel |
| J209G | Pliers, Diagonal Cutting with Grip 7-5/16" |
| J291NC | Pliers, Locking Straight 7" |
| J226G | Pliers, Needle-Nose with Cutter 6-5/8" |
| J278G | Pliers, Slip-Joint with Grip 8-1/16" |
| J260SG | Pliers, Tongue and Groove 10-3/16" with Grip |
| J413/8 | Punch, Center 3/8" |
| J471/4X3/32 | Punch, Pin 3/32" |
| J475/16X1/8 | Punch, Pin 1/8" |
| J473/8X3/16 | Punch, Pin 3/16" |
| J503/16 | Punch, Starting 1/16" |
| J505/16 | Punch, Starting 1/8" |
| J503/8 | Punch, Starting 3/16" |
| J5249 | Ratchet, 3/8" DR |
| J5449 | Ratchet, 1/2" DR |
| J2336 | Scrapers, Gasket and Carbon |
| J88313 | Screwdriver, Phillips® #1 |
| J88324 | Screwdriver, Phillips® #2 |
| J88336 | Screwdriver, Phillips® #3 |
| J88102 | Screwdriver, Slotted Keystone, Square 1/4" x 2" |
| J88104 | Screwdriver, Slotted Keystone, Square 1/4" x 4" |
| J88106 | Screwdriver, Slotted Keystone, Square 1/4" x 6" |
| J88108 | Screwdriver, Slotted Keystone, Square 1/4" x 8" |
| J88002 | Screwdriver, Slotted Keystone, Round 1/4" x 1-1/2" |
| J303S | Snips, Aviation Straight |
| J5206M | Socket, 3/8" DR 6 mm 12 PT |
| J5207M | Socket, 3/8" DR 7 mm 12 PT |
| J5208M | Socket, 3/8" DR 8 mm 12 PT |
| J5209M | Socket, 3/8" DR 9 mm 12 PT |
| J5210M | Socket, 3/8" DR 10 mm 12 PT |
| J5211M | Socket, 3/8" DR 11 mm 12 PT |

(CONTINUED ON NEXT PAGE)



99 PC METRIC STARTER SET (CONTINUED)

METRIC



Product #: **J99420**

| Contents | Description | Contents | Description |
|----------|-----------------------------|-----------|---------------------------------|
| J5212M | Socket, 3/8" DR 12 mm 12 PT | J5423M | Socket, 1/2" DR 23 mm 12 PT |
| J5213M | Socket, 3/8" DR 13 mm 12 PT | J5424M | Socket, 1/2" DR 24 mm 12 PT |
| J5214M | Socket, 3/8" DR 14 mm 12 PT | J5425M | Socket, 1/2" DR 25 mm 12 PT |
| J5215M | Socket, 3/8" DR 15 mm 12 PT | J5426M | Socket, 1/2" DR 26 mm 12 PT |
| J5216M | Socket, 3/8" DR 16 mm 12 PT | J706 | Wrench, Adjustable 6" |
| J5217M | Socket, 3/8" DR 17 mm 12 PT | J710 | Wrench, Adjustable 10" |
| J5218M | Socket, 3/8" DR 18 mm 12 PT | J1207MA | Wrench, Combination 7 mm 12 PT |
| J5219M | Socket, 3/8" DR 19 mm 12 PT | J1208MA | Wrench, Combination 8 mm 12 PT |
| J5410M | Socket, 1/2" DR 10 mm 12 PT | J1209MA | Wrench, Combination 9 mm 12 PT |
| J5411M | Socket, 1/2" DR 11 mm 12 PT | J1210MASD | Wrench, Combination 10 mm 12 PT |
| J5412M | Socket, 1/2" DR 12 mm 12 PT | J1211MASD | Wrench, Combination 11 mm 12 PT |
| J5413M | Socket, 1/2" DR 13 mm 12 PT | J1212MASD | Wrench, Combination 12 mm 12 PT |
| J5414M | Socket, 1/2" DR 14 mm 12 PT | J1213MASD | Wrench, Combination 13 mm 12 PT |
| J5415M | Socket, 1/2" DR 15 mm 12 PT | J1214MASD | Wrench, Combination 14 mm 12 PT |
| J5416M | Socket, 1/2" DR 16 mm 12 PT | J1215MASD | Wrench, Combination 15 mm 12 PT |
| J5417M | Socket, 1/2" DR 17 mm 12 PT | J1216MASD | Wrench, Combination 16 mm 12 PT |
| J5418M | Socket, 1/2" DR 18 mm 12 PT | J1217MASD | Wrench, Combination 17 mm 12 PT |
| J5419M | Socket, 1/2" DR 19 mm 12 PT | J1218MASD | Wrench, Combination 18 mm 12 PT |
| J5420M | Socket, 1/2" DR 20 mm 12 PT | J1219MASD | Wrench, Combination 19 mm 12 PT |
| J5421M | Socket, 1/2" DR 21 mm 12 PT | J1220MASD | Wrench, Combination 20 mm 12 PT |
| J5422M | Socket, 1/2" DR 22 mm 12 PT | J1221MASD | Wrench, Combination 21 mm 12 PT |

99 PC METRIC STARTER SET WITH TOOL BOX J9969-NA

METRIC



Product #: **J99421**

- ▶ 99 Pieces.
- ▶ 3/8", 1/2" Drive Tools.
- ▶ Designed for fastener sizes 6 mm - 26 mm.
- ▶ Contains: 42 Sockets and Accessories, 17 Wrenches, 15 Striking and Struck Tools, 5 Pliers, 8 Screwdrivers, 12 Miscellaneous Tools.
- ▶ Weight: 68.0 lbs.



Representative Image; Contents May Differ



77 PC METRIC STARTER SET

METRIC



Product #: J99310

- › 77 Pieces.
- › 1/2" Drive Tools.
- › Designed for fastener sizes 7 mm - 26 mm.
- › Tools only.
- › Contains: 31 Sockets and Accessories, 17 Wrenches, 10 Striking and Struck Tools, 5 Pliers, 7 Screwdrivers, 7 Miscellaneous Tools.
- › Weight: 38.0 lbs.



Representative Image; Contents May Differ

| Contents | Description |
|-------------|--|
| J86A5/16 | Chisel, Cold 3/8" |
| J86A7/16 | Chisel, Cold 1/2" |
| J86A5/8 | Chisel, Cold 3/4" |
| J5461 | Extension, 1/2" DR 5" |
| J5463 | Extension, 1/2" DR 10" |
| J1316PD | Hammer, Ball Pein 16 oz. |
| 57-532 | Hammer, Compo-Cast® 21 oz. |
| J5467 | Handle, Hinge 1/2" DR 15-3/4" |
| J209G | Pliers, Diagonal Cutting with Grip 7-5/16" |
| J291NC | Pliers, Locking Straight 7" |
| J226G | Pliers, Needle-Nose with Cutter 6-5/8" |
| J278G | Pliers, Slip-Joint with Grip 8-1/16" |
| J260SG | Pliers, Tongue and Groove 10-3/16" with Grip |
| J411/2 | Punch, Center 1/2" |
| J413/8 | Punch, Center 3/8" |
| J961/2 | Punch, Drift 1/4" |
| J475/16X1/8 | Punch, Pin 1/8" |
| J473/8X3/16 | Punch, Pin 3/16" |
| J5449 | Ratchet, 1/2" DR |

| Contents | Description |
|----------|--|
| J88313 | Screwdriver, Phillips® #1 |
| J88324 | Screwdriver, Phillips® #2 |
| J88336 | Screwdriver, Phillips® #3 |
| J88102 | Screwdriver, Slotted Keystone, Square 1/4" x 2" |
| J88106 | Screwdriver, Slotted Keystone, Square 1/4" x 6" |
| J88108 | Screwdriver, Slotted Keystone, Square 1/4" x 8" |
| J88002 | Screwdriver, Slotted Keystone, Round 1/4" x 1-1/2" |
| J4974 | Hex Key, 7 PC Folding Set |
| J5410M | Socket, 1/2" DR 10 mm 12 PT |
| J5411M | Socket, 1/2" DR 11 mm 12 PT |
| J5412M | Socket, 1/2" DR 12 mm 12 PT |
| J5413M | Socket, 1/2" DR 13 mm 12 PT |
| J5414M | Socket, 1/2" DR 14 mm 12 PT |
| J5415M | Socket, 1/2" DR 15 mm 12 PT |
| J5416M | Socket, 1/2" DR 16 mm 12 PT |
| J5417M | Socket, 1/2" DR 17 mm 12 PT |
| J5418M | Socket, 1/2" DR 18 mm 12 PT |
| J5419M | Socket, 1/2" DR 19 mm 12 PT |
| J5420M | Socket, 1/2" DR 20 mm 12 PT |

(CONTINUED ON NEXT PAGE)



77 PC METRIC STARTER SET (CONTINUED)

METRIC



Product #: **J99310**

| Contents | Description |
|----------|----------------------------------|
| J5421M | Socket, 1/2" DR 21 mm 12 PT |
| J5422M | Socket, 1/2" DR 22 mm 12 PT |
| J5423M | Socket, 1/2" DR 23 mm 12 PT |
| J5424M | Socket, 1/2" DR 24 mm 12 PT |
| J5425M | Socket, 1/2" DR 25 mm 12 PT |
| J5426M | Socket, 1/2" DR 26 mm 12 PT |
| J5316M | Socket, 1/2" DR 16 mm 12 PT Deep |
| J5317M | Socket, 1/2" DR 17 mm 12 PT Deep |
| J5318M | Socket, 1/2" DR 18 mm 12 PT Deep |
| J5319M | Socket, 1/2" DR 19 mm 12 PT Deep |
| J5320M | Socket, 1/2" DR 20 mm 12 PT Deep |
| J5321M | Socket, 1/2" DR 21 mm 12 PT Deep |
| J5322M | Socket, 1/2" DR 22 mm 12 PT Deep |
| J5324M | Socket, 1/2" DR 24 mm 12 PT Deep |
| J5325M | Socket, 1/2" DR 25 mm 12 PT Deep |
| J5326M | Socket, 1/2" DR 26 mm 12 PT Deep |
| J708 | Wrench, Adjustable 8" |

| Contents | Description |
|-----------|---------------------------------|
| J712 | Wrench, Adjustable 12" |
| J1207MA | Wrench, Combination 7 mm 12 PT |
| J1208MA | Wrench, Combination 8 mm 12 PT |
| J1209MA | Wrench, Combination 9 mm 12 PT |
| J1210MASD | Wrench, Combination 10 mm 12 PT |
| J1211MASD | Wrench, Combination 11 mm 12 PT |
| J1212MASD | Wrench, Combination 12 mm 12 PT |
| J1213MASD | Wrench, Combination 13 mm 12 PT |
| J1214MASD | Wrench, Combination 14 mm 12 PT |
| J1215MASD | Wrench, Combination 15 mm 12 PT |
| J1216MASD | Wrench, Combination 16 mm 12 PT |
| J1217MASD | Wrench, Combination 17 mm 12 PT |
| J1218MASD | Wrench, Combination 18 mm 12 PT |
| J1219MASD | Wrench, Combination 19 mm 12 PT |
| J1220MASD | Wrench, Combination 20 mm 12 PT |
| J1221MASD | Wrench, Combination 21 mm 12 PT |

77 PC METRIC STARTER SET WITH TOOL BOX J9969-NA

METRIC



Product #: **J99311**

- › 77 Pieces.
- › 1/2" Drive Tools.
- › Designed for fastener sizes 7 mm - 26 mm.
- › Contains: 31 Sockets and Accessories, 17 Wrenches, 10 Striking and Struck Tools, 5 Pliers, 7 Screwdrivers, 7 Miscellaneous Tools.
- › Weight: 58.0 lbs.



Representative Image; Contents May Differ



67 PC METRIC STARTER SET

METRIC



Product #: J99210

- › 67 Pieces.
- › 3/8" Drive Tools.
- › Designed for fastener sizes 7 mm - 19 mm.
- › Tools only.
- › Contains: 29 Sockets and Accessories, 11 Wrenches, 10 Striking and Struck Tools, 5 Pliers, 5 Screwdrivers, 7 Miscellaneous Tools.
- › Weight: 24.0 lbs.



Representative Image; Contents May Differ

| Contents | Description |
|----------|--|
| J5270A | Adapter, Universal Joint 3/8" DR |
| J86A5/16 | Chisel, Cold 3/8" |
| J86A7/16 | Chisel, Cold 1/2" |
| J86A5/8 | Chisel, Cold 3/4" |
| J5260 | Extension, 3/8" DR 3" |
| J5260-06 | Extension, 3/8" DR 6" |
| J1316PD | Hammer, Ball Pein 16 oz. |
| 57-530 | Hammer, Compo-Cast® 10 oz. |
| J5265 | Handle, Hinge 3/8" DR 8-1/2" |
| J4974 | Hex Key, 7 PC Folding Set |
| J209G | Pliers, Diagonal Cutting with Grip 7-5/16" |
| J291NC | Pliers, Locking Straight 7" |
| J226G | Pliers, Needle-Nose with Cutter 6-5/8" |
| J278G | Pliers, Slip-Joint with Grip 8-1/16" |

| Contents | Description |
|-------------|---|
| J260SG | Pliers, Tongue and Groove 10-3/16" with Grip |
| J411/2 | Punch, Center 1/2" |
| J413/8 | Punch, Center 3/8" |
| J963/8 | Punch, Drift 3/16" |
| J475/16X1/8 | Punch, Pin 1/8" |
| J473/8X3/16 | Punch, Pin 3/16" |
| J5249 | Ratchet, 3/8" DR |
| J88313 | Screwdriver, Phillips® #1 |
| J88324 | Screwdriver, Phillips® #2 |
| J88102 | Screwdriver, Slotted Keystone, Square 1/4" x 2" |
| J88106 | Screwdriver, Slotted Keystone, Square 1/4" x 6" |
| J88108 | Screwdriver, Slotted Keystone, Square 1/4" x 8" |
| J5208M | Socket, 3/8" DR 8 mm 12 PT |
| J5209M | Socket, 3/8" DR 9 mm 12 PT |

(CONTINUED ON NEXT PAGE)



67 PC METRIC STARTER SET (CONTINUED)

METRIC



Product #: **J99210**

| Contents | Description |
|----------|----------------------------------|
| J5210M | Socket, 3/8" DR 10 mm 12 PT |
| J5211M | Socket, 3/8" DR 11 mm 12 PT |
| J5212M | Socket, 3/8" DR 12 mm 12 PT |
| J5213M | Socket, 3/8" DR 13 mm 12 PT |
| J5214M | Socket, 3/8" DR 14 mm 12 PT |
| J5215M | Socket, 3/8" DR 15 mm 12 PT |
| J5216M | Socket, 3/8" DR 16 mm 12 PT |
| J5217M | Socket, 3/8" DR 17 mm 12 PT |
| J5218M | Socket, 3/8" DR 18 mm 12 PT |
| J5219M | Socket, 3/8" DR 19 mm 12 PT |
| J5008M | Socket, 3/8" DR 8 mm 12 PT Deep |
| J5009M | Socket, 3/8" DR 9 mm 12 PT Deep |
| J5010M | Socket, 3/8" DR 10 mm 12 PT Deep |
| J5011M | Socket, 3/8" DR 11 mm 12 PT Deep |
| J5012M | Socket, 3/8" DR 12 mm 12 PT Deep |
| J5013M | Socket, 3/8" DR 13 mm 12 PT Deep |
| J5014M | Socket, 3/8" DR 14 mm 12 PT Deep |

| Contents | Description |
|-----------|----------------------------------|
| J5015M | Socket, 3/8" DR 15 mm 12 PT Deep |
| J5016M | Socket, 3/8" DR 16 mm 12 PT Deep |
| J5017M | Socket, 3/8" DR 17 mm 12 PT Deep |
| J5018M | Socket, 3/8" DR 18 mm 12 PT Deep |
| J5019M | Socket, 3/8" DR 19 mm 12 PT Deep |
| J706 | Wrench, Adjustable 6" |
| J710 | Wrench, Adjustable 10" |
| J1207MA | Wrench, Combination 7 mm 12 PT |
| J1208MA | Wrench, Combination 8 mm 12 PT |
| J1209MA | Wrench, Combination 9 mm 12 PT |
| J1210MASD | Wrench, Combination 10 mm 12 PT |
| J1211MASD | Wrench, Combination 11 mm 12 PT |
| J1212MASD | Wrench, Combination 12 mm 12 PT |
| J1213MASD | Wrench, Combination 13 mm 12 PT |
| J1214MASD | Wrench, Combination 14 mm 12 PT |
| J1215MASD | Wrench, Combination 15 mm 12 PT |

67 PC METRIC STARTER SET WITH TOOL BOX J9975-NA

METRIC



Product #: **J99211**

- › 67 Pieces.
- › 3/8" Drive Tools.
- › Designed for fastener sizes 7 mm - 19 mm.
- › Contains: 29 Sockets and Accessories, 11 Wrenches, 10 Striking and Struck Tools, 5 Pliers, 5 Screwdrivers, 7 Miscellaneous Tools.
- › Weight: 36.0 lbs.



Representative Image; Contents May Differ



131 PC SMALL TOOL SET

Product #: J99100

- › 131 Pieces.
- › 1/4" Drive Tools.
- › Designed for fastener sizes 5/64" - 3/4".
- › Tools only.
- › Contains: 44 Sockets and Accessories, 28 Wrenches, 6 Striking and Struck Tools, 14 Pliers, 23 Screwdrivers, 16 Miscellaneous Tools.
- › Weight: 25.0 lbs.



Representative Image; Contents May Differ

| Contents | Description | Contents | Description |
|----------|----------------------------------|-------------|--|
| J4770A | Adapter, Universal Joint 1/4" DR | J282G | Pliers, Chain Nose 4-7/8" |
| J86A3/16 | Chisel, Cold 1/4" | J285G | Pliers, Diagonal Cutting with Grip 4-5/8" |
| J4769 | Driver, 1/4" DR | J209G | Pliers, Diagonal Cutting with Grip 7-5/16" |
| J4759 | Extension, 1/4" DR 2" | J227G | Pliers, Duckbill with Grip 7-25/32" |
| J4760 | Extension, 1/4" DR 3" | J286LNXL | Pliers, Locking Mini Long Nose 6-29/32" |
| J4761 | Extension, 1/4" DR 6" | J291NC | Pliers, Locking Straight 7" |
| J4763 | Extension, 1/4" DR 14" | J220G | Pliers, Needle-Nose 6-5/8" |
| J4765 | Extension, Flex 1/4" DR 6-1/4" | J225G | Pliers, Needle-Nose Bent Nose 6-5/16" |
| J2302 | File, Ignition PT | J222G | Pliers, Needle-Nose Long Thin 6-1/16" |
| J1304PD | Hammer, Ball Pein 4 oz. | J226G | Pliers, Needle-Nose with Cutter 6-5/8" |
| 57-595 | Hammer, Soft Face 16 oz. | J261SG | Pliers, Tongue and Groove 5" with Grip |
| J4766 | Handle, Hinge 1/4" DR 5-3/4" | J260SG | Pliers, Tongue and Groove 10-3/16" with Grip |
| J4785 | Handle, Sliding T 1/4" DR | J298 | Pliers, Wire Strippers 8-1/4" |
| J4780G | Handle, Speed 1/4 DR | J411/4 | Punch, Center |
| J4980 | Hex Key, 13 PC Standard Set | J471/4X1/16 | Punch, Pin 1/16" |
| J9206H | Nut Driver, 3/16" Hollow Shaft | J441/4 | Punch, Prick |
| J9208H | Nut Driver, 1/4" Hollow Shaft | J4749 | Ratchet, 1/4" DR |
| J9210H | Nut Driver, 5/16" Hollow Shaft | J9884 | Screw Starter, Phillips® Tip |
| J9211H | Nut Driver, 11/32" Hollow Shaft | J341/4 | Offset Screwdriver, Phillips® |
| J9212H | Nut Driver, 3/8" Hollow Shaft | J361/4 | Offset Screwdriver, Standard Tip |
| J9214H | Nut Driver, 7/16" Hollow Shaft | J308 | Snips, Miniature |
| J9216H | Nut Driver, 1/2" Hollow Shaft | J4706 | Socket, 1/4" DR 3/16" 6 PT |
| J92021/2 | Nut Driver, 5/64" Midget | J4707 | Socket, 1/4" DR 7/32" 6 PT |
| J9203 | Nut Driver, 3/32" Midget | J4708 | Socket, 1/4" DR 1/4" 6 PT |
| J92031/2 | Nut Driver, 7/64" Midget | J4709 | Socket, 1/4" DR 9/32" 6 PT |
| J9204 | Nut Driver, 1/8" Midget | J4710 | Socket, 1/4" DR 5/16" 6 PT |
| J9205 | Nut Driver, 5/32" Midget | J4711 | Socket, 1/4" DR 11/32" 6 PT |

(CONTINUED ON NEXT PAGE)



131 PC SMALL TOOL SET (CONTINUED)

Product #: **J99100**



| Contents | Description | Contents | Description |
|----------|---|----------|--|
| J4712 | Socket, 1/4" DR 3/8" 6 PT | J704G | Wrench, Adjustable 4" with Grip |
| J4714 | Socket, 1/4" DR 7/16" 6 PT | J706G | Wrench, Adjustable 6" with Grip |
| J4716 | Socket, 1/4" DR 1/2" 6 PT | J3328 | Wrench, Angle 7/16" |
| J4718 | Socket, 1/4" DR 9/16" 6 PT | J3332 | Wrench, Angle 1/2" |
| J4706L | Socket, 1/4" DR 3/16" 6 PT Deep | J3336 | Wrench, Angle 9/16" |
| J4707L | Socket, 1/4" DR 7/32" 6 PT Deep | J3340 | Wrench, Angle 5/8" |
| J4708L | Socket, 1/4" DR 1/4" 6 PT Deep | J3210 | Wrench, Angle 13/64" x 15/64" Short |
| J4709L | Socket, 1/4" DR 9/32" 6 PT Deep | J3215 | Wrench, Angle 7/32" x 1/4" Short |
| J4710L | Socket, 1/4" DR 5/16" 6 PT Deep | J3211 | Wrench, Angle 15/64" x 13/64" Short |
| J4711L | Socket, 1/4" DR 11/32" 6 PT Deep | J3216 | Wrench, Angle 1/4" x 7/32" Short |
| J4712L | Socket, 1/4" DR 3/8" 6 PT Deep | J3220 | Wrench, Angle 9/32" x 5/16" Short |
| J4714L | Socket, 1/4" DR 7/16" 6 PT Deep | J3221 | Wrench, Angle 5/16" x 9/32" Short |
| J4716L | Socket, 1/4" DR 1/2" 6 PT Deep | J3225 | Wrench, Angle 11/32" x 3/8" Short |
| J4718L | Socket, 1/4" DR 9/16" 6 PT Deep | J3226 | Wrench, Angle 3/8" x 11/32" Short |
| J4708S | Socket, 1/4" DR 1/4" 8 PT | J1204EF | Wrench, Combination 1/8" 6 PT Short |
| J4712S | Socket, 1/4" DR 3/8" 8 PT | J1205EF | Wrench, Combination 5/32" 6 PT Short |
| J4710S | Socket, 1/4" DR 5/16" 8 PT | J1206EF | Wrench, Combination 3/16" 6 PT Short |
| J4738 | Socket, Bit 1/4" DR #2 Phillips® | J1208EF | Wrench, Combination 1/4" 6 PT Short |
| J4737 | Socket, Bit 1/4" DR #1 Phillips® | J1209EF | Wrench, Combination 9/32" 6 PT Short |
| J4743 | Socket, Bit 1/4" DR Slotted 1/4" 1-3/16" | J1210EF | Wrench, Combination 5/16" 6 PT Short |
| J4744 | Socket, Bit 1/4" DR Slotted 3/16" | J1211EF | Wrench, Combination 11/32" 6 PT Short |
| J4745 | Socket, Bit 1/4" DR Slotted 1/4" 1-13/64" | J1212EF | Wrench, Combination 3/8" 6 PT Short |
| J4764 | Socket, Driver 1/4" DR Flexible | J1214EF | Wrench, Combination 7/16" 6 PT Short |
| J4771A | Socket, Universal 1/4" DR 1/4" 6 PT | J1216EF | Wrench, Combination 1/2" 6 PT Short |
| J4772A | Socket, Universal 1/4" DR 5/16" 6 PT | J1218EF | Wrench, Combination 9/16" 6 PT Short |
| J4773A | Socket, Universal 1/4" DR 3/8" 6 PT | J1220EF | Wrench, Combination 5/8" 6 PT Short |
| J4774A | Socket, Universal 1/4" DR 7/16" 6 PT | J1222TF | Wrench, Combination 11/16" 12 PT Short |
| 66-568 | Screwdriver, 8 PC Stanley® 100 Plus® Vinyl Grip Set | J1224TF | Wrench, Combination 3/4" 12 PT Short |

131 PC SMALL TOOL SET WITH TOOL BOX J9993-NA

Product #: **J99101**



- ▶ 131 Pieces.
- ▶ 1/4" Drive Tools.
- ▶ Designed for fastener sizes 5/64" - 3/4".
- ▶ Contains: 46 Sockets and Accessories, 28 Wrenches, 6 Striking and Struck Tools, 13 Pliers, 23 Screwdrivers, 15 Miscellaneous Tools.
- ▶ Weight: 42.0 lbs.

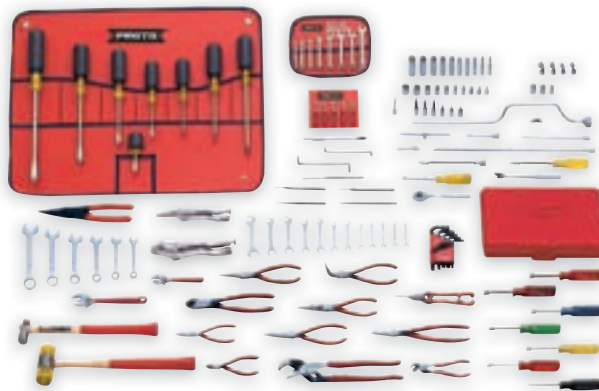

Representative Image; Contents May Differ



111 PC METRIC ADD-ON SET



Product #: J99570

- › 111 Pieces.
- › 1/4", 3/8", 1/2" Drive Tools.
- › Designed for fastener sizes 4 mm - 24 mm.
- › Tools only.

- › Contains: 84 Sockets and Accessories, 18 Wrenches, 9 Hex Keys.
- › Weight: 28.0 lbs.

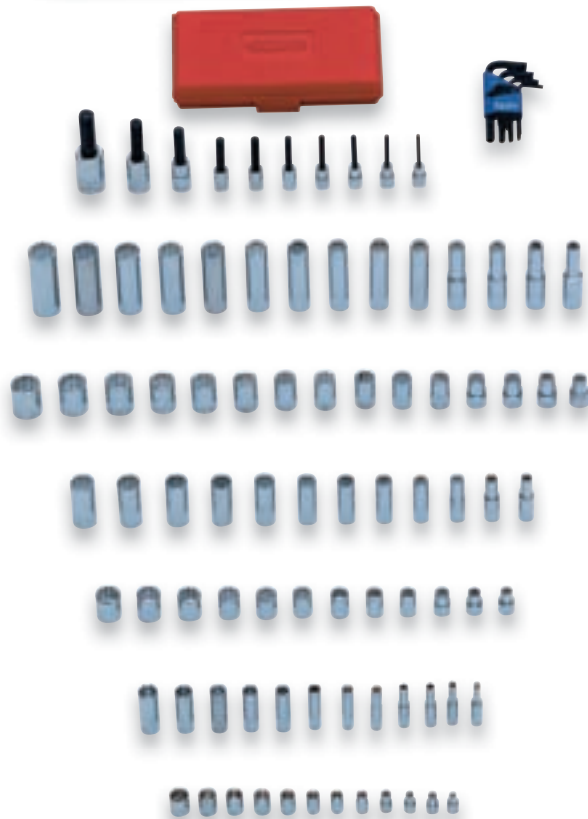

Representative Image; Contents May Differ

| Contents | Description |
|----------|-----------------------------|
| J4984 | Hex Key, 9 PC Metric Set |
| J4704M | Socket, 1/4" DR 4 mm 6 PT |
| J4705M | Socket, 1/4" DR 5 mm 6 PT |
| J47055M | Socket, 1/4" DR 5.5 mm 6 PT |
| J4706M | Socket, 1/4" DR 6 mm 6 PT |
| J4707M | Socket, 1/4" DR 7 mm 6 PT |
| J4708M | Socket, 1/4" DR 8 mm 6 PT |
| J4709M | Socket, 1/4" DR 9 mm 6 PT |
| J4710M | Socket, 1/4" DR 10 mm 6 PT |
| J4711M | Socket, 1/4" DR 11 mm 6 PT |
| J4712M | Socket, 1/4" DR 12 mm 6 PT |
| J4713M | Socket, 1/4" DR 13 mm 6 PT |

| Contents | Description |
|----------|----------------------------------|
| J4714LM | Socket, 1/4" DR 14 mm 6 PT Deep |
| J5208M | Socket, 3/8" DR 8 mm 12 PT |
| J5209M | Socket, 3/8" DR 9 mm 12 PT |
| J5210M | Socket, 3/8" DR 10 mm 12 PT |
| J5211M | Socket, 3/8" DR 11 mm 12 PT |
| J5212M | Socket, 3/8" DR 12 mm 12 PT |
| J5213M | Socket, 3/8" DR 13 mm 12 PT |
| J5214M | Socket, 3/8" DR 14 mm 12 PT |
| J5215M | Socket, 3/8" DR 15 mm 12 PT |
| J5216M | Socket, 3/8" DR 16 mm 12 PT |
| J5217M | Socket, 3/8" DR 17 mm 12 PT |
| J5218M | Socket, 3/8" DR 18 mm 12 PT |
| J5219M | Socket, 3/8" DR 19 mm 12 PT |
| J5008M | Socket, 3/8" DR 8 mm 12 PT Deep |
| J5009M | Socket, 3/8" DR 9 mm 12 PT Deep |
| J5010M | Socket, 3/8" DR 10 mm 12 PT Deep |
| J5011M | Socket, 3/8" DR 11 mm 12 PT Deep |
| J5012M | Socket, 3/8" DR 12 mm 12 PT Deep |
| J5013M | Socket, 3/8" DR 13 mm 12 PT Deep |
| J5014M | Socket, 3/8" DR 14 mm 12 PT Deep |
| J5015M | Socket, 3/8" DR 15 mm 12 PT Deep |
| J5016M | Socket, 3/8" DR 16 mm 12 PT Deep |
| J5017M | Socket, 3/8" DR 17 mm 12 PT Deep |
| J5018M | Socket, 3/8" DR 18 mm 12 PT Deep |
| J5019M | Socket, 3/8" DR 19 mm 12 PT Deep |
| J5410M | Socket, 1/2" DR 10 mm 12 PT |
| J5411M | Socket, 1/2" DR 11 mm 12 PT |
| J5412M | Socket, 1/2" DR 12 mm 12 PT |
| J5413M | Socket, 1/2" DR 13 mm 12 PT |
| J5414M | Socket, 1/2" DR 14 mm 12 PT |
| J5415M | Socket, 1/2" DR 15 mm 12 PT |
| J5416M | Socket, 1/2" DR 16 mm 12 PT |
| J5417M | Socket, 1/2" DR 17 mm 12 PT |
| J5418M | Socket, 1/2" DR 18 mm 12 PT |
| J5419M | Socket, 1/2" DR 19 mm 12 PT |
| J5420M | Socket, 1/2" DR 20 mm 12 PT |
| J5421M | Socket, 1/2" DR 21 mm 12 PT |
| J5422M | Socket, 1/2" DR 22 mm 12 PT |
| J5423M | Socket, 1/2" DR 23 mm 12 PT |
| J5424M | Socket, 1/2" DR 24 mm 12 PT |
| J5310M | Socket, 1/2" DR 10 mm 12 PT Deep |
| J5311M | Socket, 1/2" DR 11 mm 12 PT Deep |
| J5312M | Socket, 1/2" DR 12 mm 12 PT Deep |
| J5313M | Socket, 1/2" DR 13 mm 12 PT Deep |
| J5314M | Socket, 1/2" DR 14 mm 12 PT Deep |
| J5315M | Socket, 1/2" DR 15 mm 12 PT Deep |
| J5316M | Socket, 1/2" DR 16 mm 12 PT Deep |
| J5317M | Socket, 1/2" DR 17 mm 12 PT Deep |
| J5318M | Socket, 1/2" DR 18 mm 12 PT Deep |
| J5319M | Socket, 1/2" DR 19 mm 12 PT Deep |
| J5320M | Socket, 1/2" DR 20 mm 12 PT Deep |

(CONTINUED ON NEXT PAGE)



111 PC METRIC ADD-ON SET (CONTINUED)

METRIC



Product #: **J99570**

| Contents | Description |
|-----------|----------------------------------|
| J5321M | Socket, 1/2" DR 21 mm 12 PT Deep |
| J5322M | Socket, 1/2" DR 22 mm 12 PT Deep |
| J5323M | Socket, 1/2" DR 23 mm 12 PT Deep |
| J5324M | Socket, 1/2" DR 24 mm 12 PT Deep |
| J4990-4M | Socket, Hex Bit 3/8" DR 4 mm |
| J4990-5M | Socket, Hex Bit 3/8" DR 5 mm |
| J4990-6M | Socket, Hex Bit 3/8" DR 6 mm |
| J4990-7M | Socket, Hex Bit 3/8" DR 7 mm |
| J4990-8M | Socket, Hex Bit 3/8" DR 8 mm |
| J4990-9M | Socket, Hex Bit 3/8" DR 9 mm |
| J4990-10M | Socket, Hex Bit 3/8" DR 10 mm |
| J5441-12M | Socket, Hex Bit 1/2" DR 12 mm |
| J5441-14M | Socket, Hex Bit 1/2" DR 14 mm |
| J5441-17M | Socket, Hex Bit 1/2" DR 17 mm |
| J1207MA | Wrench, Combination 7 mm 12 PT |
| J1208MA | Wrench, Combination 8 mm 12 PT |

| Contents | Description |
|-----------|---------------------------------|
| J1209MA | Wrench, Combination 9 mm 12 PT |
| J1210MASD | Wrench, Combination 10 mm 12 PT |
| J1211MASD | Wrench, Combination 11 mm 12 PT |
| J1212MASD | Wrench, Combination 12 mm 12 PT |
| J1213MASD | Wrench, Combination 13 mm 12 PT |
| J1214MASD | Wrench, Combination 14 mm 12 PT |
| J1215MASD | Wrench, Combination 15 mm 12 PT |
| J1216MASD | Wrench, Combination 16 mm 12 PT |
| J1217MASD | Wrench, Combination 17 mm 12 PT |
| J1218MASD | Wrench, Combination 18 mm 12 PT |
| J1219MASD | Wrench, Combination 19 mm 12 PT |
| J1220MASD | Wrench, Combination 20 mm 12 PT |
| J1221MASD | Wrench, Combination 21 mm 12 PT |
| J1222MASD | Wrench, Combination 22 mm 12 PT |
| J1223MASD | Wrench, Combination 23 mm 12 PT |
| J1224MASD | Wrench, Combination 24 mm 12 PT |

111 PC METRIC ADD-ON SET WITH TOP CHEST J442710-4RD-IC

METRIC



Product #: **J99571**

- › 111 Pieces.
- › 1/4", 3/8", 1/2" Drive Tools.
- › Designed for fastener sizes 4 mm - 24 mm.
- › Contains: 84 Sockets and Accessories, 18 Wrenches, 9 Hex Keys.
- › Weight: 106.0 lbs.



111 PC METRIC ADD-ON SET WITH TOP CHEST J442719-8RD

METRIC

Product #: **J99572**

- › 111 Pieces.
- › 1/4", 3/8", 1/2" Drive Tools.
- › Designed for fastener sizes 4 mm - 24 mm.
- › Contains: 84 Sockets and Accessories, 18 Wrenches, 9 Hex Keys.
- › Weight: 168.0 lbs



92 PC HEAVY EQUIPMENT SET

Product #: J98310

- › 92 Pieces.
- › 3/8", 1/2", 3/4" Drive Tools.
- › Designed for fastener sizes 5/16" - 2-1/4".
- › Contains: 52 Sockets and Accessories, 21 Wrenches, 8 Striking and Struck Tools, 5 Pliers, 3 Screwdrivers, 3 Miscellaneous Tools.
- › Weight: 77.0 lbs.

Representative Image; Contents May Differ



| Contents | Description |
|----------|--|
| J5653 | Adapter 1/2" F x 3/4" M |
| J5254 | Adapter 1/2" F x 3/8" M |
| J5253 | Adapter 3/8" F x 1/2" M |
| J5470A | Adapter, Universal Joint 1/2" DR |
| J2126 | Bar, 12" Long 1/2" Tip |
| J86A5/16 | Chisel, Cold 3/8" |
| J86A5/8 | Chisel, Cold 3/4" |
| J5260 | Extension, 3/8" DR 3" |
| J5261 | Extension, 3/8" DR 8" |
| J5463 | Extension, 1/2" DR 10" |
| J5661 | Extension, 3/4" DR 8" |
| J000AA | Feeler Gauge, 25 Blade Master Set |
| J1312PD | Hammer, Ball Pein 12 oz. |
| J1332PD | Hammer, Ball Pein 32 oz. |
| J1364 | Hammer, Soft Face 1-11/16" |
| J5468 | Handle, Hinge 1/2" DR |
| J5668 | Handle, Hinge 3/4" DR 20" |
| J5280G | Handle, Speed 3/8" DR |
| J276 | Pliers, Combination 6-1/2" |
| J207G | Pliers, Diagonal Cutting with Grip 7-5/16" |
| J292NC | Pliers, Locking Curved 10" |
| J226G | Pliers, Needle-Nose with Cutter 6-5/8" |
| J260SG | Pliers, Tongue and Groove 10-3/16" with Grip |
| J417/16 | Punch, Center |
| J963/8 | Punch, Drift 3/16" |
| J963/4 | Punch, Drift 3/8" |

| Contents | Description |
|----------|---|
| J5249 | Ratchet, 3/8" DR |
| J5449 | Ratchet, 1/2" DR |
| J5649 | Ratchet, 3/4" DR |
| J2336 | Scrapers, Gasket and Carbon |
| J88206 | Screwdriver, Slotted Cabinet, Round 1/8" x 6" |
| J88006 | Screwdriver, Slotted Round 6" |
| J88008 | Screwdriver, Slotted Round 8" |
| J5208 | Socket, 3/8" DR 1/4" 12 PT |
| J5210 | Socket, 3/8" DR 5/16" 12 PT |
| J5212 | Socket, 3/8" DR 3/8" 12 PT |
| J5214 | Socket, 3/8" DR 7/16" 12 PT |
| J5216 | Socket, 3/8" DR 1/2" 12 PT |
| J5218 | Socket, 3/8" DR 9/16" 12 PT |
| J5220 | Socket, 3/8" DR 5/8" 12 PT |
| J5224 | Socket, 3/8" DR 3/4" 12 PT |
| J5416 | Socket, 1/2" DR 1/2" 12 PT |
| J5418 | Socket, 1/2" DR 9/16" 12 PT |
| J5420 | Socket, 1/2" DR 5/8" 12 PT |
| J5422 | Socket, 1/2" DR 11/16" 12 PT |
| J5424 | Socket, 1/2" DR 3/4" 12 PT |
| J5426 | Socket, 1/2" DR 13/16" 12 PT |
| J5428 | Socket, 1/2" DR 7/8" 12 PT |
| J5430 | Socket, 1/2" DR 15/16" 12 PT |
| J5432 | Socket, 1/2" DR 1" 12 PT |
| J5528 | Socket, 3/4" DR 7/8" 12 PT |
| J5530 | Socket, 3/4" DR 15/16" 12 PT |

(CONTINUED ON NEXT PAGE)

92 PC HEAVY EQUIPMENT SET (CONTINUED)

Product #: **J98310**



| Contents | Description |
|----------|---------------------------------------|
| J5532 | Socket, 3/4" DR 1" 12 PT |
| J5534 | Socket, 3/4" DR 1-1/16" 12 PT |
| J5536 | Socket, 3/4" DR 1-1/8" 12 PT |
| J5540 | Socket, 3/4" DR 1-1/4" 12 PT |
| J5542 | Socket, 3/4" DR 1-5/16" 12 PT |
| J5548 | Socket, 3/4" DR 1-1/2" 12 PT |
| J5552 | Socket, 3/4" DR 1-5/8" 12 PT |
| J5554 | Socket, 3/4" DR 1-11/16" 12 PT |
| J5556 | Socket, 3/4" DR 1-3/4" 12 PT |
| J5560 | Socket, 3/4" DR 1-7/8" 12 PT |
| J5564 | Socket, 3/4" DR 2" 12 PT |
| J5568 | Socket, 3/4" DR 2-1/8" 12 PT |
| J5570 | Socket, 3/4" DR 2-3/16" 12 PT |
| J5572 | Socket, 3/4" DR 2-1/4" 12 PT |
| J5274A | Socket, Universal 3/8" DR 7/16" 12 PT |
| J5275A | Socket, Universal 3/8" DR 1/2" 12 PT |
| J5276A | Socket, Universal 3/8" DR 9/16" 12 PT |
| J5277A | Socket, Universal 3/8" DR 5/8" 12 PT |
| J5279A | Socket, Universal 3/8" DR 3/4" 12 PT |
| J1208A | Wrench, Combination 1/4" 12 PT |

| Contents | Description |
|----------|-----------------------------------|
| J1210A | Wrench, Combination 5/16" 12 PT |
| J1212ASD | Wrench, Combination 3/8" 12 PT |
| J1214ASD | Wrench, Combination 7/16" 12 PT |
| J1216ASD | Wrench, Combination 1/2" 12 PT |
| J1218ASD | Wrench, Combination 9/16" 12 PT |
| J1220ASD | Wrench, Combination 5/8" 12 PT |
| J1222ASD | Wrench, Combination 11/16" 12 PT |
| J1224ASD | Wrench, Combination 3/4" 12 PT |
| J1226ASD | Wrench, Combination 13/16" 12 PT |
| J1228ASD | Wrench, Combination 7/8" 12 PT |
| J1230ASD | Wrench, Combination 15/16" 12 PT |
| J1232ASD | Wrench, Combination 1" 12 PT |
| J1234ASD | Wrench, Combination 1-1/16" 12 PT |
| J1236ASD | Wrench, Combination 1-1/8" 12 PT |
| J1240ASD | Wrench, Combination 1-1/4" 12 PT |
| J1242 | Wrench, Combination 1-5/16" 12 PT |
| J1244 | Wrench, Combination 1-3/8" 12 PT |
| J1248 | Wrench, Combination 1-1/2" 12 PT |
| J1252 | Wrench, Combination 1-5/8" 12 PT |
| J3426 | Wrench, Tappet 1/2" x 9/16" Thin |

92 PC HEAVY EQUIPMENT SET WITH TOP CHEST J442715-6RD-D

Product #: **J98311**



- › 92 Pieces.
- › 3/8", 1/2", 3/4" Drive Tools.
- › Designed for fastener sizes 5/16" - 2-1/4".
- › Contains: 52 Sockets and Accessories, 21 Wrenches, 8 Striking and Struck Tools, 5 Pliers, 3 Screwdrivers, 3 Miscellaneous Tools.
- › Weight: 151.0 lbs.



92 PC HEAVY EQUIPMENT SET WITH TOP CHEST J442719-8RD

Product #: **J98312**



- › 92 Pieces.
- › 3/8", 1/2", 3/4" Drive Tools.
- › Designed for fastener sizes 5/16" - 2-1/4".
- › Contains: 52 Sockets and Accessories, 21 Wrenches, 8 Striking and Struck Tools, 5 Pliers, 3 Screwdrivers, 3 Miscellaneous Tools.
- › Weight: 217.0 lbs.



71 PC MASTER HEAVY EQUIPMENT SET

Product #: J98300

- ▶ 71 Pieces.
- ▶ 3/4", 1" Drive Tools.
- ▶ Designed for fastener sizes 1" - 3-1/2".

- ▶ Contains: 46 Sockets and Accessories, 16 Wrenches, 3 Striking and Struck Tools, 6 Miscellaneous Tools.
- ▶ Weight: 228.0 lbs.



Representative Image; Contents May Differ

| Contents | Description |
|----------|-----------------------------------|
| J5453 | Adapter, 3/4" F x 1/2" M |
| J5853 | Adapter, 3/4" F x 1" M |
| J5854 | Adapter, 1" F x 3/4" M |
| J5670 | Adapter, Universal Joint 3/4" DR |
| J2125 | Bar, Pry Aligning 30" |
| J2126 | Bar, 12" Long 1/2" Tip |
| J2130 | Bar, 16" Long 5/8" Tip |
| J2120 | Bar, Pry Aligning 18" |
| J5660 | Extension, 3/4" DR 4" |
| J5661 | Extension, 3/4" DR 8" |
| J5663 | Extension, 3/4" DR 16" |
| J5861 | Extension 8", 1" DR |
| J5863 | Extension 17", 1" DR |
| J1430-HB | Hammer Head |
| J1340PD | Hammer, Ball Pein 40 oz. |
| J1332PD | Hammer, Ball Pein 32 oz. |
| J5685 | Handle, Sliding T 3/4" DR |
| J4226CA | Puller, Crossarm 2 Way |
| J4018 | Puller, Jaw 10 Ton Cap Screw |
| J4016A | Puller, Jaw 10 Ton Dual-Reach |
| J4017 | Puller, Jaw 10 Ton Narrow |
| J4332N | Puller, Nut Hex |
| J4332R | Puller, Rod Threaded 5/8"-18 UNF |
| J4225S | Puller, Screw Forcing Acme |
| J4332P | Puller, Separator Plate |
| J4011S | Puller, Spring Clip |
| J4012T | Puller, Tip Detachable |
| J5647 | Ratchet, 3/4" DR |
| J5649 | Ratchet, 3/4" DR |
| J5885 | Sliding Drive Plug 1" DR |
| J5884 | Handling, Sliding T 1" DR 28-1/2" |
| J5542HL | Socket, 3/4" DR 6 PT Deep 1-5/16" |
| J5544HL | Socket, 3/4" DR 6 PT Deep 1-3/8" |
| J5546HL | Socket, 3/4" DR 6 PT Deep 1-7/16" |
| J5548HL | Socket, 3/4" DR 8 PT Deep 1-1/2" |
| J5552HL | Socket, 3/4" DR 6 PT Deep 1-5/8" |
| J5542 | Socket, 3/4" DR 1-5/16" 12 PT |
| J5544 | Socket, 3/4" DR 1-3/8" 12 PT |
| J5546 | Socket, 3/4" DR 1-7/16" 12 PT |
| J5548 | Socket, 3/4" DR 1-1/2" 12 PT |
| J5550 | Socket, 3/4" DR 1-9/16" 12 PT |
| J5552 | Socket, 3/4" DR 1-5/8" 12 PT |
| J5554 | Socket, 3/4" DR 1-11/16" 12 PT |
| J5556 | Socket, 3/4" DR 1-3/4" 12 PT |
| J5558 | Socket, 3/4" DR 1-13/16" 12 PT |
| J5560 | Socket, 3/4" DR 1-7/8" 12 PT |
| J5564 | Socket, 3/4" DR 2" 12 PT |
| J5568 | Socket, 3/4" DR 2-1/8" 12 PT |
| J5570 | Socket, 3/4" DR 2-3/16" 12 PT |
| J5572 | Socket, 3/4" DR 2-1/4" 12 PT |
| J5576 | Socket, 3/4" DR 2-3/8" 12 PT |

(CONTINUED ON NEXT PAGE)

71 PC MASTER HEAVY EQUIPMENT SET (CONTINUED)

Product #: **J98300**



| Contents | Description |
|----------|------------------------------|
| J5764 | Socket, 1" DR 2" 12 PT |
| J5770 | Socket, 1" DR 2-3/16" 12 PT |
| J5772 | Socket, 1" DR 2-1/4" 12 PT |
| J5776 | Socket, 1" DR 2-3/8" 12 PT |
| J5780 | Socket, 1" DR 2-1/2" 12 PT |
| J5782 | Socket, 1" DR 2-9/16" 12 PT |
| J5784 | Socket, 1" DR 2-5/8" 12 PT |
| J5788 | Socket, 1" DR 2-3/4" 12 PT |
| J5794 | Socket, 1" DR 2-15/16" 12 PT |
| J5796 | Socket, 1" DR 3" 12 PT |
| J5800 | Socket, 1" DR 3-1/8" 12 PT |
| J5812 | Socket, 1" DR 3-1/2" 12 PT |
| J715 | Wrench, Adjustable 15" |
| J724 | Wrench, Adjustable 24" |

| Contents | Description |
|----------|------------------------------------|
| J1232ASD | Wrench, Combination 1" 12 PT |
| J1234ASD | Wrench, Combination 1-1/16" 12 PT |
| J1236ASD | Wrench, Combination 1-1/8" 12 PT |
| J1240ASD | Wrench, Combination 1-1/4" 12 PT |
| J1242 | Wrench, Combination 1-5/16" 12 PT |
| J1244 | Wrench, Combination 1-3/8" 12 PT |
| J1246 | Wrench, Combination 1-7/16" 12 PT |
| J1248 | Wrench, Combination 1-1/2" 12 PT |
| J1252 | Wrench, Combination 1-5/8" 12 PT |
| J1254 | Wrench, Combination 1-11/16" 12 PT |
| J1256 | Wrench, Combination 1-3/4" 12 PT |
| J1258 | Wrench, Combination 1-13/16" 12 PT |
| J1260 | Wrench, Combination 1-7/8" 12 PT |
| J1264 | Wrench, Combination 2" 12 PT |

71 PC HEAVY EQUIPMENT SET WITH ROLLER CABINET J453441-8RD

Product #: **J98301**



- › 71 Pieces.
- › 3/4", 1" Drive Tools.
- › Designed for fastener sizes 1" - 3-1/2".
- › Contains: 46 Sockets and Accessories, 16 Wrenches, 3 Striking and Struck Tools,
- › 6 Miscellaneous Tools.
- › Weight: 537.0 lbs.



Representative Image; Contents May Differ



99 PC METRIC HEAVY EQUIPMENT SET

METRIC



Product #: J98320

- › 99 Pieces.
- › 3/8", 1/2", 3/4" Drive Tools.
- › Designed for fastener sizes 7 mm - 60 mm.
- › Contains: 56 Sockets and Accessories, 24 Wrenches, 8 Striking and Struck Tools, 5 Pliers, 3 Screwdrivers, 3 Miscellaneous Tools.
- › Weight: 91.0 lbs.

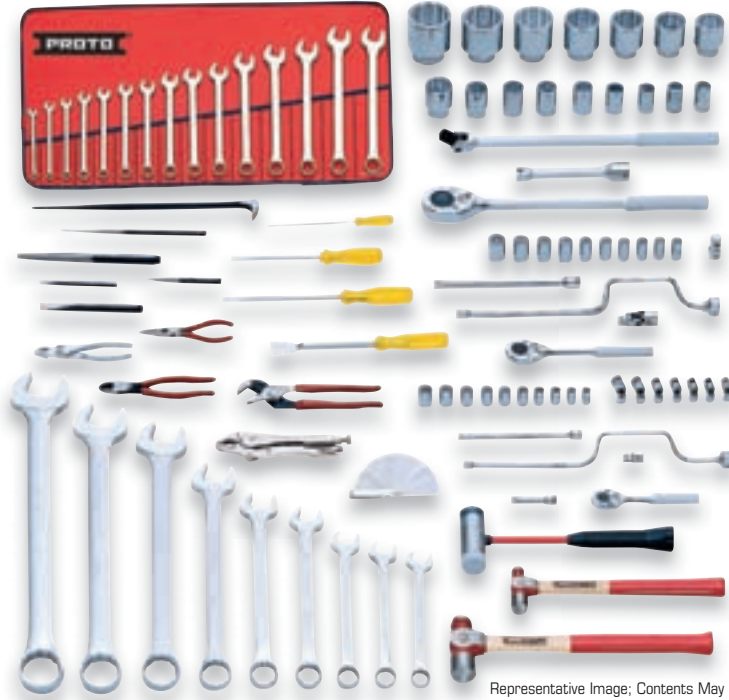

Representative Image; Contents May Differ

| Contents | Description |
|----------|---|
| J5253 | Adapter, 3/8" F x 1/2" M |
| J5653 | Adapter, 1/2" F x 3/4" M |
| J5470A | Adapter, Universal Joint 1/2" DR |
| J2126 | Bar, 12" Long 1/2" Tip |
| J86A5/16 | Chisel, Cold 3/8" |
| J86A5/8 | Chisel, Cold 3/4" |
| J5260 | Extension, 3/8" DR 3" |
| J5261 | Extension, 3/8" DR 8" |
| J5463 | Extension, 1/2" DR 10" |
| J5661 | Extension, 3/4" DR 8" |
| J00MM25 | Feeler Gauge, 25 Blade Metric Set |
| J1312PD | Hammer, Ball Pein 12 oz. |
| J1332PD | Hammer, Ball Pein 32 oz. |
| J1364 | Hammer, Soft Face 1-11/16" |
| J5668 | Handle, Hinge 3/4" DR 20" |
| J5280G | Handle, Speed 3/8" DR |
| J5480G | Handle, Speed 1/2" DR |
| J276 | Pliers, Combination 6-1/2" |
| J207G | Pliers, Diagonal Cutting with Grip 7-5/16" |
| J292NC | Pliers, Locking Curved 10" |
| J226G | Pliers, Needle-Nose with Cutter 6-5/8" |
| J260SG | Pliers, Tongue and Groove 10-3/16" with Grip |
| J417/16 | Punch, Center |
| J963/8 | Punch, Drift 3/16" |
| J963/4 | Punch, Drift 3/8" |
| J5249 | Ratchet, 3/8" DR |
| J5449 | Ratchet, 1/2" DR |
| J5649 | Ratchet, 3/4" DR |
| J2336 | Scrapers, Gasket and Carbon |
| J88206 | Screwdriver, Slotted Cabinet, Round 1/8" x 6" |

| Contents | Description |
|----------|-------------------------------|
| J88006 | Screwdriver, Slotted Round 6" |
| J88008 | Screwdriver, Slotted Round 8" |
| J5210M | Socket, 3/8" DR 10 mm 12 PT |
| J5211M | Socket, 3/8" DR 11 mm 12 PT |
| J5212M | Socket, 3/8" DR 12 mm 12 PT |
| J5213M | Socket, 3/8" DR 13 mm 12 PT |
| J5214M | Socket, 3/8" DR 14 mm 12 PT |
| J5215M | Socket, 3/8" DR 15 mm 12 PT |
| J5216M | Socket, 3/8" DR 16 mm 12 PT |
| J5217M | Socket, 3/8" DR 17 mm 12 PT |
| J5218M | Socket, 3/8" DR 18 mm 12 PT |
| J5219M | Socket, 3/8" DR 19 mm 12 PT |
| J5413M | Socket, 1/2" DR 13 mm 12 PT |
| J5414M | Socket, 1/2" DR 14 mm 12 PT |
| J5415M | Socket, 1/2" DR 15 mm 12 PT |
| J5416M | Socket, 1/2" DR 16 mm 12 PT |
| J5417M | Socket, 1/2" DR 17 mm 12 PT |
| J5418M | Socket, 1/2" DR 18 mm 12 PT |
| J5419M | Socket, 1/2" DR 19 mm 12 PT |
| J5421M | Socket, 1/2" DR 21 mm 12 PT |
| J5422M | Socket, 1/2" DR 22 mm 12 PT |
| J5424M | Socket, 1/2" DR 24 mm 12 PT |
| J5521M | Socket, 3/4" DR 21 mm 12 PT |
| J5522M | Socket, 3/4" DR 22 mm 12 PT |
| J5523M | Socket, 3/4" DR 23 mm 12 PT |
| J5524M | Socket, 3/4" DR 24 mm 12 PT |
| J5527M | Socket, 3/4" DR 27 mm 12 PT |
| J5528M | Socket, 3/4" DR 28 mm 12 PT |
| J5530M | Socket, 3/4" DR 30 mm 12 PT |

(CONTINUED ON NEXT PAGE)



99 PC METRIC HEAVY EQUIPMENT SET (CONTINUED)

METRIC



Product #: **J98320**

| Contents | Description |
|-----------|---------------------------------------|
| J5532M | Socket, 3/4" DR 32 mm 12 PT |
| J5536M | Socket, 3/4" DR 36 mm 12 PT |
| J5541M | Socket, 3/4" DR 41 mm 12 PT |
| J5542M | Socket, 3/4" DR 42 mm 12 PT |
| J5546M | Socket, 3/4" DR 46 mm 12 PT |
| J5550M | Socket, 3/4" DR 50 mm 12 PT |
| J5555M | Socket, 3/4" DR 55 mm 12 PT |
| J5558M | Socket, 3/4" DR 58 mm 12 PT |
| J5560M | Socket, 3/4" DR 60 mm 12 PT |
| J5272AM | Socket, Universal 3/8" DR 9 mm 12 PT |
| J5273AM | Socket, Universal 3/8" DR 10 mm 12 PT |
| J5274AM | Socket, Universal 3/8" DR 11 mm 12 PT |
| J5275AM | Socket, Universal 3/8" DR 12 mm 12 PT |
| J5276AM | Socket, Universal 3/8" DR 13 mm 12 PT |
| J5277AM | Socket, Universal 3/8" DR 14 mm 12 PT |
| J5278AM | Socket, Universal 3/8" DR 15 mm 12 PT |
| J1207MA | Wrench, Combination 7 mm 12 PT |
| J1208MA | Wrench, Combination 8 mm 12 PT |
| J1209MA | Wrench, Combination 9 mm 12 PT |
| J1210MASD | Wrench, Combination 10 mm 12 PT |

| Contents | Description |
|-----------|--|
| J1211MASD | Wrench, Combination 11 mm 12 PT |
| J1212MASD | Wrench, Combination 12 mm 12 PT |
| J1213MASD | Wrench, Combination 13 mm 12 PT |
| J1214MASD | Wrench, Combination 14 mm 12 PT |
| J1215MASD | Wrench, Combination 15 mm 12 PT |
| J1216MASD | Wrench, Combination 16 mm 12 PT |
| J1217MASD | Wrench, Combination 17 mm 12 PT |
| J1218MASD | Wrench, Combination 18 mm 12 PT |
| J1219MASD | Wrench, Combination 19 mm 12 PT |
| J1220MASD | Wrench, Combination 20 mm 12 PT |
| J1221MASD | Wrench, Combination 21 mm 12 PT |
| J1222MASD | Wrench, Combination 22 mm 12 PT |
| J1224MASD | Wrench, Combination 24 mm 12 PT |
| J1228MASD | Wrench, Combination 28 mm 12 PT |
| J1232MASD | Wrench, Combination 32 mm 12 PT |
| J1241M | Wrench, Combination 41 mm 12 PT |
| J1246M | Wrench, Combination 46 mm 12 PT |
| J1250M | Wrench, Combination 50 mm 12 PT |
| J1226MASD | Wrench, Combination 26 mm 12 PT Satin Finish |
| J1236M | Wrench, Combination 36 mm 12 PT Satin Finish |

99 PC METRIC HEAVY-DUTY EQUIPMENT SET WITH TOP CHEST J442715-6RD-D

METRIC



Product #: **J98321**

- › 99 Pieces.
- › 3/8", 1/2", 3/4" Drive Tools.
- › Designed for fastener sizes 7 mm - 60 mm.
- › Contains: 56 Sockets and Accessories, 24 Wrenches, 8 Striking and Struck Tools, 5 Pliers, 3 Screwdrivers, 3 Miscellaneous Tools.
- › Weight: 165.0 lbs.



99 PC METRIC HEAVY EQUIPMENT SET WITH TOP CHEST J442719-8RD

METRIC



Product #: **J98322**

- › 99 Pieces.
- › 3/8", 1/2", 3/4" Drive Tools.
- › Designed for fastener sizes 7 mm - 60 mm.
- › Contains: 56 Sockets and Accessories, 24 Wrenches, 8 Striking and Struck Tools, 5 Pliers, 3 Screwdrivers, 3 Miscellaneous Tools.
- › Weight: 231.0 lbs.



411 PC AIRCRAFT MAINTENANCE SET

Product #: JTS-0411AIR



- › 411 Pieces.
- › 1/4", 3/8", 1/2" Drive Tools.
- › Designed for fastener sizes 1/16" - 1".
- › Tools only.
- › Contains: 173 Sockets and Accessories, 107 Wrenches, 17 Striking and Struck Tools, 17 Pliers, 40 Screwdrivers, 57 Miscellaneous Tools.
- › Enhanced version of Proto® J98200 Aircraft Maintenance Set.
- › Weight: 129.0 lbs



Representative Image; Contents May Differ

| Contents | Description | Contents | Description |
|----------|----------------------------------|-----------|--|
| J5112 | Adapter, Torque 3/8" DR 3/8" | J5260-06L | Extension, Locking 3/8" DR 6" |
| J5114 | Adapter, Torque 3/8" DR 7/16" | J5262L | Extension, Locking 3/8" DR 12" |
| J5116 | Adapter, Torque 3/8" DR 1/2" | J5461L | Extension, Locking 1/2" DR 5" |
| J5118 | Adapter, Torque 3/8" DR 9/16" | J5463L | Extension, Locking 1/2" DR 10" |
| J5120 | Adapter, Torque 3/8" DR 5/8" | J4760W | Extension, Wobble 1/4" DR 3" |
| J5122 | Adapter, Torque 3/8" DR 11/16" | J5260-06W | Extension, Wobble 3/8" DR 6" |
| J5124 | Adapter, Torque 3/8" DR 3/4" | J5461W | Extension, Wobble 1/2" DR 5" |
| J5126 | Adapter, Torque 3/8" DR 13/16" | J000AA | Feeler Gauge, 25 Blade Master Set |
| J5128 | Adapter, Torque 3/8" DR 7/8" | 95-112W | Flashlight, Stanley® Tripod - 20 Lumens |
| J4770A | Adapter, Universal Joint 1/4" DR | J2337 | Flexible Carbon Scraper |
| J5270A | Adapter, Universal Joint 3/8" DR | J2344 | Retrieval Tool, Flexible |
| J5470A | Adapter, Universal Joint 1/2" DR | J2336 | Gasket Scraper and Carbon Scraper |
| J2116 | Bar, Pry Aligning 16" | 20-001 | Stanley® Hacksaw, High Tension Low Profile 12" |
| J725/16 | Chisel, Cape 13/64" | J1316PD | Hammer, Ball Pein 16 oz. |
| J86A1/4 | Chisel, Cold 5/16" | J1308PD | Hammer, Ball Pein 8 oz. |
| J86A3/8 | Chisel, Cold 7/16" | 57-532 | Hammer, Compo-Cast® 21 oz. |
| J86A7/16 | Chisel, Cold 1/2" | 57-533 | Hammer, Compo-Cast® Soft-Face 42 oz. |
| J765/16 | Chisel, Diamond PT 3/16" | J5265 | Handle, Hinge 3/8" DR 8-1/2" |
| J4769 | Driver, 1/4" DR | J5285 | Handle, Sliding T 3/8" DR |
| J4759L | Extension, Locking 1/4" DR 2" | J5480G | Handle, Speed 1/2" DR |
| J4761L | Extension, Locking 1/4" DR 6" | J4780G | Handle, Speed 1/4" DR |
| J5261 | Extension, 3/8" DR 8" | J5280G | Handle, Speed 3/8" DR |
| J5260 | Extension, 3/8" DR 3" | J4980 | Hex Key, 13 PC Standard Set |
| J5260-06 | Extension, 3/8" DR 6" | J5467 | Handle, Hinge 1/2" DR 15-3/4" |
| J5262 | Extension, 3/8" DR 12" | J2108 | Holder, Punch and Chisel |

(CONTINUED ON NEXT PAGE)



411 PC AIRCRAFT MAINTENANCE SET (CONTINUED)

Product #: JTS-0411AIR



| Contents | Description | Contents | Description |
|-------------|--|----------|--|
| 10-189C | Knife, Self-Retracting Utility | J341/4 | Offset Screwdriver, Phillips® |
| J2373 | Mirror, Rectangular Telescoping 2-1/8" | J343/8 | Offset Screwdriver, Phillips® |
| J9206H | Nut Driver, 3/16" Hollow Shaft | J361/4 | Offset Screwdriver, Standard Tip |
| J9208H | Nut Driver, 1/4" Hollow Shaft | J363/8 | Offset Screwdriver, Standard Tip |
| J9210H | Nut Driver, 5/16" Hollow Shaft | J9322 | Screwdriver, Magnetic Ratcheting Bit Set |
| J9211H | Nut Driver, 11/32" Hollow Shaft | J000K | Gauge, Spark Plug Gap Gauge Set |
| J9212H | Nut Driver, 3/8" Hollow Shaft | J303L | Snips, Aviation Left |
| J9214H | Nut Driver, 7/16" Hollow Shaft | J303R | Snips, Aviation Right |
| J9216H | Nut Driver, 1/2" Hollow Shaft | J303S | Snips, Aviation Straight |
| J2806SMP | Pliers, 6 PC Mini Set | J4706T | Socket, 1/4" DR 3/16" 12 PT |
| J253G | Pliers, Cannon Plug Soft Jaw 9/12" | J4707T | Socket, 1/4" DR 7/32" 12 PT |
| J206G | Pliers, Diagonal Cutting with Grip 6-1/16" | J4708T | Socket, 1/4" DR 1/4" 12 PT |
| J227G | Pliers, Duckbill with Grip 7-25/32" | J4709T | Socket, 1/4" DR 9/32" 12 PT |
| J291NC | Pliers, Locking Straight 7" | J4710T | Socket, 1/4" DR 5/16" 12 PT |
| J226G | Pliers, Needle-Nose with Cutter 6-5/8" | J4711T | Socket, 1/4" DR 11/32" 12 PT |
| J360B | Pliers, 12 PC Set Convertible Retaining Ring | J4712T | Socket, 1/4" DR 3/8" 12 PT |
| J276G | Pliers, Slip-Joint with Grip 6-9/16" | J4714T | Socket, 1/4" DR 7/16" 12 PT |
| J298 | Pliers, Wire Strippers 8-1/4" | J4716T | Socket, 1/4" DR 1/2" 12 PT |
| J197 | Pliers, Wire Twister Reversible 11" | J4718T | Socket, 1/4" DR 9/16" 12 PT |
| J2306 | Puller, Cotter Pin Tool | J4706LT | Socket, 1/4" DR 3/16" 12 PT Deep |
| J413/8 | Punch, Center 3/8" | J4707LT | Socket, 1/4" DR 7/32" 12 PT Deep |
| J471/4X3/32 | Punch, Pin 3/32" | J4708LT | Socket, 1/4" DR 1/4" 12 PT Deep |
| J475/16X1/8 | Punch, Pin 1/8" | J4709LT | Socket, 1/4" DR 9/32" 12 PT Deep |
| J473/8X3/16 | Punch, Pin 3/16" | J4710LT | Socket, 1/4" DR 5/16" 12 PT Deep |
| J503/16 | Punch, Starting 1/16" | J4711LT | Socket, 1/4" DR 11/32" 12 PT Deep |
| J505/16 | Punch, Starting 1/8" | J4712LT | Socket, 1/4" DR 3/8" 12 PT Deep |
| J503/8 | Punch, Starting 3/16" | J4714LT | Socket, 1/4" DR 7/16" 12 PT Deep |
| J4749HS | Ratchet, 1/4" DR Aerospace | J4716LT | Socket, 1/4" DR 1/2" 12 PT Deep |
| J4749XL | Ratchet, 1/4" DR Standard Length Pear Head | J4718LT | Socket, 1/4" DR 9/16" 12 PT Deep |
| J5249HS | Ratchet, 3/8" DR Aerospace | J4706SPL | Socket, 1/4" DR 3/16" #6 Spline |
| J5248S | Ratchet, 3/8" DR Stubby | J4707SPL | Socket, 1/4" DR 7/32" #7 Spline |
| J5247 | Ratchet, Adapter 3/8" DR 5/16" | J4708SPL | Socket, 1/4" DR 1/4" #8 Spline |
| J5249XL | Ratchet, 3/8" DR Standard Length Premium Pear Head | J4709SPL | Socket, 1/4" DR 9/32" #9 Spline |
| J5449XL | Ratchet, 1/2" DR Standard Length Premium Pear Head | J4710SPL | Socket, 1/4" DR 5/16" #10 Spline |
| J2375 | Retrieval Tool, Pocket Magnetic | J4712SPL | Socket, 1/4" DR 3/8" #12 Spline |
| 46-123 | Square, Combination Prem Etched Blade 12" | J4714SPL | Socket, 1/4" DR 7/16" #14 Spline |
| 28-240 | Scraper, Flexible Nylon 1-1/4" | J4706DPL | Socket, 1/4" DR 3/16" #6 Spline Deep |
| J9884 | Screw Starter, Phillips® Tip | J4707DPL | Socket, 1/4" DR 7/32" #7 Spline Deep |
| J9853 | Screw Starter, Standard Tip | J4708DPL | Socket, 1/4" DR 1/4" #8 Spline Deep |
| J88004 | Screwdriver Slotted Round 4" | J4709DPL | Socket, 1/4" DR 9/32" #9 Spline Deep |
| J88010 | Screwdriver Slotted Round 10" | J4710DPL | Socket, 1/4" DR 5/16" #10 Spline Deep |
| J88203 | Screwdriver, Slotted Cabinet, Round 1/8" x 3" | J4712DPL | Socket, 1/4" DR 3/8" #12 Spline Deep |
| J88204 | Screwdriver, Slotted Cabinet, Round 1/8" x 4" | J4714DPL | Socket, 1/4" DR 7/16" #14 Spline Deep |
| J88208 | Screwdriver, Slotted Cabinet, Round 1/8" x 8" | J5208S | Socket, 3/8" DR 1/4" 8 PT |
| J88206 | Screwdriver, Slotted Cabinet, Round 1/8" x 6" | J5210S | Socket, 3/8" DR 5/16" 8 PT |
| J88214 | Screwdriver, Slotted Cabinet, Round 3/16" x 4" | J5212S | Socket, 3/8" DR 3/8" 8 PT |
| J88393 | Screwdriver, Phillips® #0 | J5214S | Socket, 3/8" DR 7/16" 8 PT |
| J88313 | Screwdriver, Phillips® #1 | J5216S | Socket, 3/8" DR 1/2" 8 PT |
| J88322 | Screwdriver, Phillips® #2 | J5208 | Socket, 3/8" DR 1/4" 12 PT |
| J88324 | Screwdriver, Phillips® #2 | J5210 | Socket, 3/8" DR 5/16" 12 PT |
| J88336 | Screwdriver, Phillips® #3 | J5212 | Socket, 3/8" DR 3/8" 12 PT |
| J88348 | Screwdriver, Phillips® #4 | J5214 | Socket, 3/8" DR 7/16" 12 PT |
| J88002 | Screwdriver, Slotted Keystone, Round 1/4" x 1-1/2" | J5216 | Socket, 3/8" DR 1/2" 12 PT |
| J88006 | Screwdriver, Slotted Round 6" | J5218 | Socket, 3/8" DR 9/16" 12 PT |
| J88008 | Screwdriver, Slotted Round 8" | J5220 | Socket, 3/8" DR 5/8" 12 PT |
| | | J5222 | Socket, 3/8" DR 11/16" 12 PT |





| Contents | Description |
|----------|--|
| J5224 | Socket, 3/8" DR 3/4" 12 PT |
| J5226 | Socket, 3/8" DR 13/16" 12 PT |
| J5228 | Socket, 3/8" DR 7/8" 12 PT |
| J5230 | Socket, 3/8" DR 15/16" 12 PT |
| J5232 | Socket, 3/8" DR 1" 12 PT |
| J5008 | Socket, 3/8" DR 1/4" 12 PT Deep |
| J5010 | Socket, 3/8" DR 5/16" 12 PT Deep |
| J5012 | Socket, 3/8" DR 3/8" 12 PT Deep |
| J5014 | Socket, 3/8" DR 7/16" 12 PT Deep |
| J5016 | Socket, 3/8" DR 1/2" 12 PT Deep |
| J5018 | Socket, 3/8" DR 9/16" 12 PT Deep |
| J5020 | Socket, 3/8" DR 5/8" 12 PT Deep |
| J5022 | Socket, 3/8" DR 11/16" 12 PT Deep |
| J5024 | Socket, 3/8" DR 3/4" 12 PT Deep |
| J5026 | Socket, 3/8" DR 13/16" 12 PT Deep |
| J5028 | Socket, 3/8" DR 7/8" 12 PT Deep |
| J5030 | Socket, 3/8" DR 15/16" 12 PT Deep |
| J5032 | Socket, 3/8" DR 1" 12 PT Deep |
| J5212SPL | Socket, 3/8" DR 3/8" #12 Spline |
| J5214SPL | Socket, 3/8" DR 7/16" #14 Spline |
| J5216SPL | Socket, 3/8" DR 1/2" #16 Spline |
| J5218SPL | Socket, 3/8" DR 9/16" #18 Spline |
| J5220SPL | Socket, 3/8" DR 5/8" #20 Spline |
| J5012DPL | Socket, 3/8" DR 3/8" #12 Spline Deep |
| J5014DPL | Socket, 3/8" DR 7/16" #14 Spline Deep |
| J5016DPL | Socket, 3/8" DR 1/2" #16 Spline Deep |
| J5018DPL | Socket, 3/8" DR 9/16" #18 Spline Deep |
| J5020DPL | Socket, 3/8" DR 5/8" #20 Spline Deep |
| J5414 | Socket, 1/2" DR 7/16" 12 PT |
| J5416 | Socket, 1/2" DR 1/2" 12 PT |
| J5418 | Socket, 1/2" DR 9/16" 12 PT |
| J5420 | Socket, 1/2" DR 5/8" 12 PT |
| J5422 | Socket, 1/2" DR 11/16" 12 PT |
| J5424 | Socket, 1/2" DR 3/4" 12 PT |
| J5426 | Socket, 1/2" DR 13/16" 12 PT |
| J5428 | Socket, 1/2" DR 7/8" 12 PT |
| J5430 | Socket, 1/2" DR 15/16" 12 PT |
| J5432 | Socket, 1/2" DR 1" 12 PT |
| J5416SPL | Socket, 1/2" DR 1/2" #16 Spline |
| J5418SPL | Socket, 1/2" DR 9/16" #18 Spline |
| J5420SPL | Socket, 1/2" DR 5/8" #20 Spline |
| J5422SPL | Socket, 1/2" DR 11/16" #22 Spline |
| J5424SPL | Socket, 1/2" DR 3/4" #24 Spline |
| J5426SPL | Socket, 1/2" DR 13/16" #26 Spline |
| J5428SPL | Socket, 1/2" DR 7/8" #28 Spline |
| J5430SPL | Socket, 1/2" DR 15/16" #30 Spline |
| J5316DPL | Socket, 1/2" DR 1/2" #16 Spline Deep |
| J5318DPL | Socket, 1/2" DR 9/16" #18 Spline Deep |
| J5320DPL | Socket, 1/2" DR 5/8" #20 Spline Deep |
| J5322DPL | Socket, 1/2" DR 11/16" #22 Spline Deep |
| J5324DPL | Socket, 1/2" DR 3/4" #24 Spline Deep |
| J5326DPL | Socket, 1/2" DR 13/16" #26 Spline Deep |
| J5328DPL | Socket, 1/2" DR 7/8" #28 Spline Deep |
| J5330DPL | Socket, 1/2" DR 15/16" #30 Spline Deep |
| J5241 | Socket, Bit 3/8" DR #2 Phillips® |
| J5242 | Socket, Bit 3/8" DR #3 Phillips® |
| J5243 | Socket, Bit 3/8" DR #4 Phillips® |
| J5246 | Socket, Bit 3/8" DR Slotted |

| Contents | Description |
|-----------|---|
| J69X09 | Socket, Extractor 1/4" DR 7 mm |
| J69X10 | Socket, Extractor 1/4" DR 8 mm |
| J69X11 | Socket, Extractor 1/4" DR 9 mm |
| J69X13 | Socket, Extractor 1/4" DR 10 mm |
| J69X14 | Socket, Extractor 1/4" DR 11 mm |
| J69X15 | Socket, Extractor 1/4" DR 12 mm |
| J69X16 | Socket, Extractor 1/4" DR 13 mm |
| J69X18 | Socket, Extractor 1/4" DR 14 mm |
| J69X20 | Socket, Extractor 1/4" DR 15 mm |
| J69X12 | Socket, Extractor 3/8" |
| J47701/16 | Socket, Hex Bit 1/4" DR 1/16" |
| J47705/64 | Socket, Hex Bit 1/4" DR 5/64" |
| J47703/32 | Socket, Hex Bit 1/4" DR 3/32" |
| J47707/64 | Socket, Hex Bit 1/4" DR 7/64" |
| J47701/8 | Socket, Hex Bit 1/4" DR 1/8" |
| J47709/64 | Socket, Hex Bit 1/4" DR 9/64" |
| J47705/32 | Socket, Hex Bit 1/4" DR 5/32" |
| J47703/16 | Socket, Hex Bit 1/4" DR 3/16" |
| J47707/32 | Socket, Hex Bit 1/4" DR 7/32" |
| J47701/4 | Socket, Hex Bit 1/4" DR 1/4" |
| J47705/16 | Socket, Hex Bit 1/4" DR 5/16" |
| J49901/8 | Socket, Hex Bit 3/8" DR 1/8" |
| J49905/32 | Socket, Hex Bit 3/8" DR 5/32" |
| J49903/16 | Socket, Hex Bit 3/8" DR 3/16" |
| J49907/32 | Socket, Hex Bit 3/8" DR 7/32" |
| J49901/4 | Socket, Hex Bit 3/8" DR 1/4" |
| J49905/16 | Socket, Hex Bit 3/8" DR 5/16" |
| J49903/8 | Socket, Hex Bit 3/8" DR 3/8" |
| J4771TA | Socket, Universal 1/4" DR 1/4" 12 PT |
| J4772TA | Socket, Universal 1/4" DR 5/16" 12 PT |
| J4773TA | Socket, Universal 1/4" DR 3/8" 12 PT |
| J4774TA | Socket, Universal 1/4" DR 7/16" 12 PT |
| J5273A | Socket, Universal 3/8" DR 3/8" 12 PT |
| J5274A | Socket, Universal 3/8" DR 7/16" 12 PT |
| J5275A | Socket, Universal 3/8" DR 1/2" 12 PT |
| J5276A | Socket, Universal 3/8" DR 9/16" 12 PT |
| J5277A | Socket, Universal 3/8" DR 5/8" 12 PT |
| J5278A | Socket, Universal 3/8" DR 11/16" 12 PT |
| J5279A | Socket, Universal 3/8" DR 3/4" 12 PT |
| 33-212 | Tape Rule, Stanley® Powerlock® with Metal Case 1/2" x 12' |
| J704L | Wrench, Adjustable Klik-Stop® Chrome, 4" |
| J708L | Wrench, Adjustable Klik-Stop® Chrome, 8" |
| J712L | Wrench, Adjustable Klik-Stop® Chrome, 12" |
| J3112 | Wrench, Angle 3/8" |
| J3114 | Wrench, Angle 7/16" |
| J3116 | Wrench, Angle 1/2" |
| J3118 | Wrench, Angle 9/16" |
| J3120 | Wrench, Angle 5/8" |
| J3122 | Wrench, Angle 11/16" |
| J3124 | Wrench, Angle 3/4" |
| J3126 | Wrench, Angle 13/16" |
| J3128 | Wrench, Angle 7/8" |
| J3130 | Wrench, Angle 15/16" |
| J3132 | Wrench, Angle 1" |
| J3134 | Wrench, Angle 1-1/16" |
| J3136 | Wrench, Angle 1-1/8" |
| J3140 | Wrench, Angle 1-1/4" |

(CONTINUED ON NEXT PAGE)



411 PC AIRCRAFT MAINTENANCE SET (CONTINUED)

Product #: **JTS-0411AIR**



| Contents | Description | Contents | Description |
|------------|--|----------|---|
| J1120 | Wrench, Box 5/16" x 3/8" 12 PT Short | JSCVM10 | Wrench, Combination Reversible Spline 10 mm |
| J1122 | Wrench, Box 3/8" x 7/16" 12 PT Short | JSCVM11 | Wrench, Combination Reversible Spline 11 mm |
| J1126 | Wrench, Box 1/2" x 9/16" 12 PT Short | JSCVM12 | Wrench, Combination Reversible Spline 12 mm |
| J1131 | Wrench, Box 5/8" x 3/4" 12 PT Short | JSCVM13 | Wrench, Combination Reversible Spline 13 mm |
| J8180 | Wrench, Box 3/8" x 7/16" 12 PT Deep | JSCVM14 | Wrench, Combination Reversible Spline 14 mm |
| J8181 | Wrench, Box 1/2" x 9/16" 12 PT Deep | JSCVM15 | Wrench, Combination Reversible Spline 15 mm |
| J8182 | Wrench, Box 5/8" x 11/16" 12 PT | JSCVM16 | Wrench, Combination Reversible Spline 16 mm |
| J8183A | Wrench, Box 11/16" x 13/16" 12 PT | JSCVM17 | Wrench, Combination Reversible Spline 17 mm |
| J8184 | Wrench, Box 3/4" x 7/8" 12 PT Deep | JSCVM18 | Wrench, Combination Reversible Spline 18 mm |
| J8185 | Wrench, Box 15/16" x 1" 12 PT Deep | JSCVM19 | Wrench, Combination Reversible Spline 19 mm |
| JSBV0709 | Wrench, Box Reversible Spline 7/32" x 9/32" | J4708CF | Wrench, Crowfoot 1/4" DR 1/4" Open End |
| JSBV0810 | Wrench, Box Reversible Spline 1/4" x 5/16" | J4710CF | Wrench, Crowfoot 1/4" DR 5/16" Open End |
| JSBV1214 | Wrench, Box Reversible Spline 3/8" x 7/16" | J4712CF | Wrench, Crowfoot 1/4" DR 3/8" Open End |
| JSBV1618 | Wrench, Box Reversible Spline 1/2" x 9/16" | J4714CF | Wrench, Crowfoot 1/4" DR 7/16" Open End |
| JSBV2022 | Wrench, Box Reversible Spline 5/8" x 11/16" | J4716CF | Wrench, Crowfoot 1/4" DR 1/2" Open End |
| JSBV2428 | Wrench, Box Reversible Spline 3/4" x 7/8" | J4718CF | Wrench, Crowfoot 1/4" DR 9/16" Open End |
| JSBV2630 | Wrench, Box Reversible Spline 13/16" x 15/16" | J4912CF | Wrench, Crowfoot 3/8" DR 3/8" Open End |
| JSBV3236 | Wrench, Box Reversible Spline 1" x 1-1/8" | J4914CF | Wrench, Crowfoot 3/8" DR 7/16" Open End |
| J1210-T500 | Wrench, Combination 5/16" ASD FP 12 PT | J4916CF | Wrench, Crowfoot 3/8" DR 1/2" Open End |
| J1212-T500 | Wrench, Combination 3/8" ASD FP 12 PT | J4918CF | Wrench, Crowfoot 3/8" DR 9/16" Open End |
| J1214-T500 | Wrench, Combination 7/16" ASD FP 12 PT | J4920CF | Wrench, Crowfoot 3/8" DR 5/8" Open End |
| J1216-T500 | Wrench, Combination 1/2" ASD FP 12 PT | J4922CF | Wrench, Crowfoot 3/8" DR 11/16" Open End |
| J1218-T500 | Wrench, Combination 9/16" ASD FP 12 PT | J4924CF | Wrench, Crowfoot 3/8" DR 3/4" Open End |
| J1220-T500 | Wrench, Combination 5/8" ASD FP 12 PT | J4926CF | Wrench, Crowfoot 3/8" DR 13/16" Open End |
| J1222-T500 | Wrench, Combination 11/16" ASD FP 12 PT | J4928CF | Wrench, Crowfoot 3/8" DR 7/8" Open End |
| J1224-T500 | Wrench, Combination 3/4" ASD FP 12 PT | J4930CF | Wrench, Crowfoot 3/8" DR 15/16" Open End |
| J1226-T500 | Wrench, Combination 13/16" ASD FP 12 PT | J4932CF | Wrench, Crowfoot 3/8" DR 1" Open End |
| J1228-T500 | Wrench, Combination 7/8" ASD FP 12 PT | J3751 | Wrench, Flare Nut Combination 3/8" 6 PT |
| J1230-T500 | Wrench, Combination 15/16" ASD FP 12 PT | J3752 | Wrench, Flare Nut Combination 7/16" 6 PT |
| J1232-T500 | Wrench, Combination 1" ASD FP 12 PT | J3753 | Wrench, Flare Nut Combination 1/2" 6 PT |
| J1234-T500 | Wrench, Combination 1-1/16" ASD FP 12 PT | J3754 | Wrench, Flare Nut Combination 9/16" 6 PT |
| J1236-T500 | Wrench, Combination 1-1/8" ASD FP 12 PT | J3755 | Wrench, Flare Nut Combination 5/8" 6 PT |
| J1240-T500 | Wrench, Combination 1-1/4" ASD FP 12 PT | J3756 | Wrench, Flare Nut Combination 11/16" 6 PT |
| JSCV09 | Wrench, Combination Reversible Spline 9/32" #9 | J3757 | Wrench, Flare Nut Combination 3/4" 6 PT |
| JSCV10 | Wrench, Combination Reversible Spline 5/16" #10 | J1725 | Wrench, Obstruction 7/16" x 1/2" |
| JSCV12 | Wrench, Combination Reversible Spline 3/8" #12 | J1730 | Wrench, Obstruction 9/16" x 5/8" |
| JSCV14 | Wrench, Combination Reversible Spline 7/16" #14 | J1731 | Wrench, Obstruction 5/8" x 3/4" |
| JSCV16 | Wrench, Combination Reversible Spline 1/2" #16 | J3425 | Wrench, Tappet 7/16" x 1/2" Thin |
| JSCV18 | Wrench, Combination Reversible Spline 9/16" #18 | J3426 | Wrench, Tappet 1/2" x 9/16" Thin |
| JSCV20 | Wrench, Combination Reversible Spline 5/8" #20 | J3430 | Wrench, Tappet 9/16" x 5/8" Thin |
| JSCV22 | Wrench, Combination Reversible Spline 11/16" #22 | J3435 | Wrench, Tappet 11/16" x 3/4" Thin |
| JSCV24 | Wrench, Combination Reversible Spline 3/4" #24 | J3440 | Wrench, Tappet 13/16" x 7/8" Thin |
| JSCVM07 | Wrench, Combination Reversible Spline 7 mm | J6064C | Wrench, Torque 3/8" DR 40-200 in-lbs |
| JSCVM08 | Wrench, Combination Reversible Spline 8 mm | J6066C | Wrench, Torque 3/8" DR 100-1000 in-lbs |
| JSCVM09 | Wrench, Combination Reversible Spline 9 mm | J6072C | Wrench, Torque 1/2" DR 600-3000 in-lbs |



411 PC AIRCRAFT MAINTENANCE SET WITH ROLLER CABINET J453411-8RD

Product #: JTS-0411AIRBX1



- › 411 Pieces.
- › 1/4", 3/8", 1/2" Drive Tools.
- › Designed for fastener sizes 1/16" - 1".
- › Contains: 164 Sockets and Accessories, 107 Wrenches, 16 Striking and Struck Tools, 20 Pliers, 38 Screwdrivers, 66 Miscellaneous Tools.
- › Enhanced version of Proto® J98201 Aircraft Maintenance Set.
- › Weight: 438.0 lbs.



Representative Image; Contents May Differ

411 PC AIRCRAFT MAINTENANCE SET WITH ROLLER CABINET J442742-12RD AND TOP CHEST J442719-6RD

Product #: JTS-0411AIRBX2



- › 411 Pieces.
- › 1/4", 3/8", 1/2" Drive Tools.
- › Designed for fastener sizes 1/16" - 1".
- › Contains: 164 Sockets and Accessories, 107 Wrenches, 16 Striking and Struck Tools, 20 Pliers, 38 Screwdrivers, 66 Miscellaneous Tools.
- › Enhanced version of Proto® J98202 Aircraft Maintenance Set.
- › Weight: 339.0 lbs.



Representative Image; Contents May Differ



116 PC AIRCRAFT MECHANIC'S STARTER SET

Product #: **JTS-0116AIR**



- › 116 Pieces.
- › 1/4", 3/8", 1/2" Drive Tools.
- › Designed for fastener sizes 5/64" - 7/8".
- › Tools only.
- › Contains: 43 Sockets and Accessories, 16 Wrenches, 8 Striking and Struck Tools, 11 Pliers, 23 Screwdrivers, 15 Miscellaneous Tools.
- › Enhanced version of Proto® J98220 Aircraft Mechanic's Starter Set.
- › Weight: 38.0 lbs.



Representative Image; Contents May Differ

| Contents | Description |
|----------|---|
| J5253 | Adapter 3/8" F x 1/2" M |
| J4770A | Adapter, Universal Joint 1/4" DR |
| J5270A | Adapter, Universal Joint 3/8" DR |
| J86A1/2 | Chisel, Cold 5/8" |
| J4769 | Driver, 1/4" DR |
| J4759 | Extension, 1/4" DR 2" |
| J4761 | Extension, 1/4" DR 6" |
| J5262 | Extension, 3/8" DR 12" |
| J5260 | Extension, 3/8" DR 3" |
| J5260-06 | Extension, 3/8" DR 6" |
| J000AA | Feeler Gauge, 25 Blade Master Set |
| J2344 | Retrieval Tool, Flexible |
| J1308PD | Hammer, Ball Pein 8 oz. |
| 57-595 | Hammer, Soft Face 16 oz. |
| J5265 | Handle, Hinge 3/8" DR 8-1/2" |
| J5280G | Handle, Speed 3/8 DR |
| 20-001 | Stanley® High Tension Low Profile Hacksaw 12" |
| J2108 | Holder, Punch and Chisel |
| J2373 | Mirror, Rectangular Telescoping 2-1/8" |
| J206G | Pliers, Diagonal Cutting with Grip 6-1/16" |
| J227G | Pliers, Duckbill with Grip 7-25/32" |
| J291NC | Pliers, Locking Straight 7" |
| J226G | Pliers, Needle-Nose with Cutter 6-5/8" |
| J276G | Pliers, Slip-Joint with Grip 6-9/16" |
| J260SG | Pliers, Tongue and Groove 10-3/16" with Grip |
| J297 | Pliers, Wire Stripper/Cutter 6-1/16" |

| Contents | Description |
|-------------|--|
| J197 | Pliers, Wire Twister Reversible 11" |
| J413/8 | Punch, Center 3/8" |
| J475/16X1/8 | Punch, Pin 1/8" |
| J473/8X3/16 | Punch, Pin 3/16" |
| J505/16 | Punch, Starting 1/8" |
| J4749XL | Ratchet, 1/4" DR Standard Length Premium Pear Head |
| J5249XL | Ratchet, 3/8" DR Standard Length Premium Pear Head |
| J2375 | Retrieval Tool, Pocket Magnetic |
| 28-240 | Scraper, Flexible Nylon 1-1/4" |
| J88213 | Screwdriver, Cabinet 3/16" x 3" |
| J88215 | Screwdriver, Cabinet 3/16" x 5" |
| J88214 | Screwdriver, Slotted Cabinet, Round 3/16" x 4" |
| J88313 | Screwdriver, Phillips® #1 |
| J88324 | Screwdriver, Phillips® #2 |
| J88322 | Screwdriver, Phillips® #2 |
| J88336 | Screwdriver, Phillips® #3 |
| J88002 | Screwdriver, Slotted Keystone, Round 1/4" x 1-1/2" |
| J88004 | Screwdriver, Slotted Round 4" |
| J88006 | Screwdriver, Slotted Round 6" |
| J341/4 | Offset Screwdriver, Phillips® |
| J361/4 | Offset Screwdriver, Standard Tip |
| J4982 | Hex Key, 7 PC Set |
| J9322 | Screwdriver, Magnetic Ratcheting Bit Set |
| J303L | Snips, Aviation Left |
| J303R | Snips, Aviation Right |



116 PC AIRCRAFT MECHANIC'S STARTER SET (CONTINUED)

Product #: **JTS-0116AIR**



| Contents | Description | Contents | Description |
|----------|-----------------------------------|------------|---|
| J303S | Snips, Aviation Straight | J5220 | Socket, 3/8" DR 5/8" 12 PT |
| J4706T | Socket, 1/4" DR 3/16" 12 PT | J5222 | Socket, 3/8" DR 11/16" 12 PT |
| J4707T | Socket, 1/4" DR 7/32" 12 PT | J5224 | Socket, 3/8" DR 3/4" 12 PT |
| J4708T | Socket, 1/4" DR 1/4" 12 PT | J5226 | Socket, 3/8" DR 13/16" 12 PT |
| J4709T | Socket, 1/4" DR 9/32" 12 PT | J5228 | Socket, 3/8" DR 7/8" 12 PT |
| J4710T | Socket, 1/4" DR 5/16" 12 PT | J5328H | Socket, 1/2" DR 7/8" 6 PT Deep |
| J4711T | Socket, 1/4" DR 11/32" 12 PT | 95-112W | Flashlight, Stanley® Tripod - 20 Lumens |
| J4712T | Socket, 1/4" DR 3/8" 12 PT | 33-212 | Tape Rule, Stanley® Powerlock® with Metal Case 1/2" x 12' |
| J4714T | Socket, 1/4" DR 7/16" 12 PT | J710L | Wrench, Adjustable Cliq-Stop® 10" |
| J4716T | Socket, 1/4" DR 1/2" 12 PT | J1210-T500 | Wrench, Combination 5/16" ASD FP 12 PT |
| J4718T | Socket, 1/4" DR 9/16" 12 PT | J1212-T500 | Wrench, Combination 3/8" ASD FP 12 PT |
| J4706LT | Socket, 1/4" DR 3/16" 12 PT Deep | J1214-T500 | Wrench, Combination 7/16" ASD FP 12 PT |
| J4707LT | Socket, 1/4" DR 7/32" 12 PT Deep | J1216-T500 | Wrench, Combination 1/2" ASD FP 12 PT |
| J4708LT | Socket, 1/4" DR 1/4" 12 PT Deep | J1218-T500 | Wrench, Combination 9/16" ASD FP 12 PT |
| J4709LT | Socket, 1/4" DR 9/32" 12 PT Deep | J1220-T500 | Wrench, Combination 5/8" ASD FP 12 PT |
| J4710LT | Socket, 1/4" DR 5/16" 12 PT Deep | J1222-T500 | Wrench, Combination 11/16" ASD FP 12 PT |
| J4711LT | Socket, 1/4" DR 11/32" 12 PT Deep | J1224-T500 | Wrench, Combination 3/4" ASD FP 12 PT |
| J4712LT | Socket, 1/4" DR 3/8" 12 PT Deep | J1226-T500 | Wrench, Combination 13/16" ASD FP 12 PT |
| J4714LT | Socket, 1/4" DR 7/16" 12 PT Deep | J1228-T500 | Wrench, Combination 7/8" ASD FP 12 PT |
| J4716LT | Socket, 1/4" DR 1/2" 12 PT Deep | J1230-T500 | Wrench, Combination 15/16" ASD FP 12 PT |
| J4718LT | Socket, 1/4" DR 9/16" 12 PT Deep | J1232-T500 | Wrench, Combination 1" ASD FP 12 PT |
| J5212 | Socket, 3/8" DR 3/8" 12 PT | J1234-T500 | Wrench, Combination 1-1/16" ASD FP 12 PT |
| J5214 | Socket, 3/8" DR 7/16" 12 PT | J1236-T500 | Wrench, Combination 1-1/8" ASD FP 12 PT |
| J5216 | Socket, 3/8" DR 1/2" 12 PT | J1240-T500 | Wrench, Combination 1-1/4" ASD FP 12 PT |
| J5218 | Socket, 3/8" DR 9/16" 12 PT | | |

116 PC AIRCRAFT MECHANIC'S STARTER SET WITH TOOL BOX J9969-NA

Product #: **JTS-0116AIRBX1**



- › 116 Pieces.
- › 1/4", 3/8", 1/2" Drive Tools.
- › Designed for fastener sizes 5/64" - 7/8".
- › Contains: 43 Sockets and Accessories, 16 Wrenches, 7 Striking and Struck Tools, 14 Pliers, 21 Screwdrivers, 15 Miscellaneous Tools.
- › Weight: 58.0 lbs.



Representative Image; Contents May Differ



149 PC AVIONICS TECHNICIAN'S SET

Product #: **JTS-0149AVI**



- ▶ 149 Pieces.
- ▶ 1/4" Drive Tools.
- ▶ Designed for fastener sizes 1/8" - 3/4".
- ▶ Tools only.
- ▶ Contains: 34 Sockets and Accessories, 26 Wrenches, 9 Striking and Struck Tools, 14 Pliers, 52 Screwdrivers, 14 Miscellaneous Tools.
- ▶ Enhanced version of Proto® J98240 Avionics Technician's Set.
- ▶ Weight: 25.0 lbs.



Representative Image; Contents May Differ

| Contents | Description |
|----------|---|
| J4770A | Adapter, Universal Joint 1/4" DR |
| J86A1/2 | Chisel, Cold 5/8" |
| J4769 | Driver, 1/4" DR |
| J4759L | Extension, Locking 1/4" DR 2" |
| J4761L | Extension, Locking 1/4" DR 6" |
| J4765 | Extension, Flex 1/4" DR 6-1/4" |
| J4760W | Extension, Wobble 1/4" DR 3" |
| J000AA | Feeler Gauge, 25 Blade Master Set |
| 95-112W | Flashlight, Stanley® Tripod - 20 Lumens |
| J2344 | Retrieval Tool, Flexible |
| J1304PD | Hammer, Ball Pein 4 oz. |
| 57-530 | Hammer, Compo-Cast® 10 oz. |
| 57-595 | Hammer, Soft Face 16 oz. |
| J2108 | Holder, Punch and Chisel |
| J2371 | Mirror, Inspect Oval 1" x 2" |
| J9206H | Nut Driver, 3/16" Hollow Shaft |
| J9208H | Nut Driver, 1/4" Hollow Shaft |
| J9210H | Nut Driver, 5/16" Hollow Shaft |
| J9211H | Nut Driver, 11/32" Hollow Shaft |

| Contents | Description |
|----------|--|
| J9212H | Nut Driver, 3/8" Hollow Shaft |
| J9214H | Nut Driver, 7/16" Hollow Shaft |
| J9216H | Nut Driver, 1/2" Hollow Shaft |
| J92021/2 | Nut Driver, 5/64" Midget |
| J9203 | Nut Driver, 3/32" Midget |
| J92031/2 | Nut Driver, 7/64" Midget |
| J9204 | Nut Driver, 1/8" Midget |
| J9205 | Nut Driver, 5/32" Midget |
| 82-115 | Pick and Hook, 4 PC Set |
| J2806SMP | Pliers, 6 PC Mini Set |
| J206G | Pliers, Diagonal Cutting with Grip 6-1/16" |
| J227G | Pliers, Duckbill with Grip 7-25/32" |
| J225G | Pliers, Needle-Nose Bent Nose 6-5/16" |
| J222G | Pliers, Needle-Nose Long Thin 6-1/16" |
| J226G | Pliers, Needle-Nose with Cutter 6-5/8" |
| J276G | Pliers, Slip-Joint with Grip 6-9/16" |
| J260SG | Pliers, Tongue and Groove 10-3/16" with Grip |
| J297 | Pliers, Wire Stripper/Cutter 6-1/16" |
| J2306 | Puller, Cotter Pin Tool |



149 PC AVIONICS TECHNICIAN'S SET (CONTINUED)

Product #: **JTS-0149AVI**



| Contents | Description | Contents | Description |
|-------------|---|------------|--|
| J413/8 | Punch, Center 3/8" | J4706LT | Socket, 1/4" DR 3/16" 12 PT Deep |
| J475/16X1/8 | Punch, Pin 1/8" | J4707LT | Socket, 1/4" DR 7/32" 12 PT Deep |
| J473/8X3/16 | Punch, Pin 3/16" | J4708LT | Socket, 1/4" DR 1/4" 12 PT Deep |
| J505/16 | Punch, Starting 1/8" | J4709LT | Socket, 1/4" DR 9/32" 12 PT Deep |
| J4749XL | Ratchet, 1/4" DR Standard Length Premium Pear Head | J4710LT | Socket, 1/4" DR 5/16" 12 PT Deep |
| J2375 | Retrieval Tool, Pocket Magnetic | J4711LT | Socket, 1/4" DR 11/32" 12 PT Deep |
| J9884 | Screw Starter, Phillips® Tip | J4712LT | Socket, 1/4" DR 3/8" 12 PT Deep |
| J9853 | Screw Starter, Standard Tip | J4714LT | Socket, 1/4" DR 7/16" 12 PT Deep |
| J88204 | Screwdriver, Slotted Cabinet, Round 1/8" x 4" | J4716LT | Socket, 1/4" DR 1/2" 12 PT Deep |
| J88206 | Screwdriver, Slotted Cabinet, Round 1/8" x 6" | J4718LT | Socket, 1/4" DR 9/16" 12 PT Deep |
| J88214 | Screwdriver, Slotted Cabinet, Round 3/16" x 4" | J4771TA | Socket, Universal 1/4" DR 1/4" 12 PT |
| J88213 | Screwdriver, Cabinet 3/16" x 3" | J4772TA | Socket, Universal 1/4" DR 5/16" 12 PT |
| J88215 | Screwdriver, Cabinet 3/16" x 5" | J4773TA | Socket, Universal 1/4" DR 3/8" 12 PT |
| J88216 | Screwdriver, Cabinet 3/16" x 6" | J4774TA | Socket, Universal 1/4" DR 7/16" 12 PT |
| J88393 | Screwdriver, Phillips® #0 | 33-115 | Tape Rule, Measuring 1/4" x 10' |
| J88313 | Screwdriver, Phillips® #1 | J704L | Wrench, Adjustable Clik-Stop® Chrome, 4" |
| J88318 | Screwdriver, Phillips® #1 | J708L | Wrench, Adjustable Clik-Stop® Chrome, 8" |
| J88322 | Screwdriver, Phillips® #2 | J3332 | Wrench, Angle 1/2" |
| J88324 | Screwdriver, Phillips® #2 | J3316 | Wrench, Angle 1/4" |
| J88336 | Screwdriver, Phillips® #3 | J3322 | Wrench, Angle 11/32" |
| J88002 | Screwdriver, Slotted Keystone, Round 1/4" x 1-1/2" | J3315 | Wrench, Angle 15/64" |
| J88004 | Screwdriver, Slotted Round 4" | J3324 | Wrench, Angle 3/8" |
| J88006 | Screwdriver, Slotted Round 6" | J3320 | Wrench, Angle 5/16" |
| J341/4 | Offset Screwdriver, Phillips® | J3328 | Wrench, Angle 7/16" |
| J361/4 | Offset Screwdriver, Standard Tip | J3314 | Wrench, Angle 7/32" |
| J4982 | Hex Key, 7 PC Set | J3318 | Wrench, Angle 9/32" |
| J9322 | Screwdriver, Magnetic Ratcheting Bit Set | J1212-T500 | Wrench, Combination 3/8" ASD FP 12 PT |
| 66-039 | Screwdriver, 6 PC Stanley® Jewelers Precision Set | J1214-T500 | Wrench, Combination 7/16" ASD FP 12 PT |
| J4708S | Socket, 1/4" DR 1/4" 8 PT | J1216-T500 | Wrench, Combination 1/2" ASD FP 12 PT |
| J4710S | Socket, 1/4" DR 5/16" 8 PT | J1218-T500 | Wrench, Combination 9/16" ASD FP 12 PT |
| J4712S | Socket, 1/4" DR 3/8" 8 PT | J1220-T500 | Wrench, Combination 5/8" ASD FP 12 PT |
| J4706T | Socket, 1/4" DR 3/16" 12 PT | J1222-T500 | Wrench, Combination 11/16" ASD FP 12 PT |
| J4707T | Socket, 1/4" DR 7/32" 12 PT | J1224-T500 | Wrench, Combination 3/4" ASD FP 12 PT |
| J4708T | Socket, 1/4" DR 1/4" 12 PT | J1204EF | Wrench, Combination 1/8" 6 PT Short |
| J4709T | Socket, 1/4" DR 9/32" 12 PT | J1205EF | Wrench, Combination 5/32" 6 PT Short |
| J4710T | Socket, 1/4" DR 5/16" 12 PT | J1206EF | Wrench, Combination 3/16" 6 PT Short |
| J4711T | Socket, 1/4" DR 11/32" 12 PT | J1208EF | Wrench, Combination 1/4" 6 PT Short |
| J4712T | Socket, 1/4" DR 3/8" 12 PT | J1209EF | Wrench, Combination 9/32" 6 PT Short |
| J4714T | Socket, 1/4" DR 7/16" 12 PT | J1210EF | Wrench, Combination 5/16" 6 PT Short |
| J4716T | Socket, 1/4" DR 1/2" 12 PT | J1211EF | Wrench, Combination 11/32" 6 PT Short |
| J4718T | Socket, 1/4" DR 9/16" 12 PT | J1212EF | Wrench, Combination 3/8" 6 PT Short |

MASTER SETS



AVIATION SETS

149 PC AVIONICS TECHNICIAN'S SET WITH ROLLER CABINET J453441-8RD-D

Product #: **JTS-0149AVIBX1**



- › 149 Pieces.
- › 1/4" Drive Tools.
- › Designed for fastener sizes 1/8" - 3/4".
- › Contains: 34 Sockets and Accessories, 26 Wrenches, 8 Striking and Struck Tools, 17 Pliers, 46 Screwdrivers, 18 Miscellaneous Tools.
- › Enhanced version of Proto® J98241 Avionics Technician's Set.
- › Weight: 334.0 lbs.



Representative Image; Contents May Differ

149 PC MASTER AVIONICS TECHNICIAN'S SET WITH ROLLER CABINET J442742-12RD

Product #: **JTS-0149AVIBX2**



- › 149 Pieces.
- › 1/4" Drive Tools.
- › Designed for fastener sizes 3/16" - 9/16".
- › Contains: 34 Sockets and Accessories, 26 Wrenches, 8 Striking and Struck Tools, 17 Pliers, 46 Screwdrivers, 18 Miscellaneous Tools.
- › Weight: 235.0 lbs.



Representative Image; Contents May Differ



172 PC RAILROAD ROADWAY MECHANIC'S SET

Product #: JTS-0172RR



- ▶ 172 Pieces.
- ▶ 1/2", 3/8" Drive Tools.
- ▶ Designed for fastener sizes 1/4" - 1-1/2".
- ▶ Tools only.
- ▶ Contains: 68 Sockets and Accessories, 36 Wrenches, 16 Striking and Struck Tools, 26 Pliers, 7 Screwdrivers, 19 Miscellaneous Tools.
- ▶ Enhanced version of Proto® J98100 Railroad Roadway Mechanic's Set.
- ▶ Weight: 81.0 lbs.



Representative Image; Contents May Differ

| Contents | Description |
|-----------|-----------------------------------|
| J5270A | Adapter, Universal Joint 3/8" DR |
| J5470A | Adapter, Universal Joint 1/2" DR |
| J2116 | Bar, Pry Aligning 16" |
| J2126 | Bar, 12" Long 1/2" Tip |
| J725/16 | Chisel, Cape 13/64" |
| J86038 | Chisel, Cold 3/8" Super Duty |
| J86012 | Chisel, Cold 1/2" Super Duty |
| J86001 | Chisel, Cold 1" Super Duty |
| J5259B | Extension, 3/8" DR 1-3/4" Black |
| J5260B | Extension, 3/8" DR 3" Black |
| J5260-06B | Extension, 3/8" DR 6" Black |
| J5261B | Extension, 3/8" DR 8" Black |
| J5460B | Extension, 1/2" DR 2-1/2" Black |
| J5461B | Extension, 1/2" DR 5" Black |
| J5463B | Extension, 1/2" DR 10" Black |
| J000AA | Feeler Gauge, 25 Blade Master Set |
| 20-531 | Hacksaw, FatMax® High Tension 12" |

| Contents | Description |
|----------|--|
| J1316PD | Hammer, Ball Pein 16 oz. |
| JSF200 | Hammer, Soft Face without Tips |
| JSF20T | Hammer Tip, 2" Tough |
| J4980 | Hex Key, 13 PC Standard Set |
| J2108 | Holder, Punch and Chisel |
| J209G | Pliers, Diagonal Cutting with Grip 7-5/16" |
| J292NC | Pliers, Locking Curved 10" |
| J291NC | Pliers, Locking Straight 7" |
| J226G | Pliers, Needle-Nose with Cutter 6-5/8" |
| J278G | Pliers, Slip-Joint with Grip 8-1/16" |
| J260SG | Pliers, Tongue and Groove 10-3/16" with Grip |
| J265SG | Pliers, Tongue and Groove 16" with Grip |
| J298 | Pliers, Wire Strippers 8-1/4" |
| J415/16 | Punch, Center |
| J965/16 | Punch, Drift 1/8" |
| J961/2 | Punch, Drift 1/4" |
| J48116 | Punch, Pin, 1/16" Super Duty |

(CONTINUED ON NEXT PAGE)

172 PC RAILROAD ROADWAY MECHANIC'S SET (CONTINUED)

Product #: JTS-0172RR



| Contents | Description | Contents | Description |
|----------|---|-----------|--|
| J48018 | Punch, Pin, 1/8" Super Duty | J5330B | Socket, 1/2" DR 15/16" 12 PT Deep Black Oxide |
| J48316 | Punch, Pin, 3/16" Super Duty | J5332B | Socket, 1/2" DR 1" 12 PT Deep Black Oxide |
| J48038 | Punch, Pin, 3/8" Super Duty | J5334B | Socket, 1/2" DR 1-1/16" 12 PT Deep Black Oxide |
| J48532 | Punch, Pin, 5/32" Super Duty | J5336B | Socket, 1/2" DR 1-1/8" 12 PT Deep Black Oxide |
| J5249BL | Ratchet, 3/8" DR Female | J5246 | Socket, Bit 3/8" DR Slotted |
| J5449BL | Ratchet, 1/2" DR Black | J49901/8 | Socket, Hex Bit 3/8" DR 1/8" |
| J2375 | Retrieval Tool, Pocket Magnetic | J49905/32 | Socket, Hex Bit 3/8" DR 5/32" |
| J2345 | Retriever and Holder Tool, Flexible | J49903/16 | Socket, Hex Bit 3/8" DR 3/16" |
| J9853 | Screw Starter, Standard Tip | J49901/4 | Socket, Hex Bit 3/8" DR 1/4" |
| J88322 | Screwdriver, Phillips® #2 | J49907/32 | Socket, Hex Bit 3/8" DR 7/32" |
| J88324 | Screwdriver, Phillips® #2 | J49905/16 | Socket, Hex Bit 3/8" DR 5/16" |
| J88102 | Screwdriver, Slotted Keystone, Square 1/4" x 2" | J49903/8 | Socket, Hex Bit 3/8" DR 3/8" |
| J88106 | Screwdriver, Slotted Keystone, Square 1/4" x 6" | J54411/2 | Socket, Hex Bit 1/2" DR 1/2" |
| J88108 | Screwdriver, Slotted Keystone, Square 1/4" x 8" | J54419/16 | Socket, Hex Bit 1/2" DR 9/16" |
| J88110 | Screwdriver, Slotted Keystone, Square 1/4" x 10" | J54415/8 | Socket, Hex Bit 1/2" DR 5/8" |
| J380 | Pliers, 6 PC Retaining Ring Set with Replacement Tips | J5273A | Socket, Universal 3/8" DR 3/8" 12 PT |
| J5212B | Socket, 3/8" DR 3/8" 12 PT Black Oxide | J5274A | Socket, Universal 3/8" DR 7/16" 12 PT |
| J5214B | Socket, 3/8" DR 7/16" 12 PT Black Oxide | J5275A | Socket, Universal 3/8" DR 1/2" 12 PT |
| J5216B | Socket, 3/8" DR 1/2" 12 PT Black Oxide | J5276A | Socket, Universal 3/8" DR 9/16" 12 PT |
| J5218B | Socket, 3/8" DR 9/16" 12 PT Black Oxide | J712SL | Wrench, Adjustable Klik-Stop® 1" |
| J5220B | Socket, 3/8" DR 5/8" 12 PT Black Oxide | J715SL | Wrench, Adjustable Klik-Stop® 1" |
| J5222B | Socket, 3/8" DR 11/16" 12 PT Black Oxide | J708SL | Wrench, Adjustable Klik-Stop® 8" |
| J5224B | Socket, 3/8" DR 3/4" 12 PT Black Oxide | J1212BASP | Wrench, Combination 3/8" 12 PT Black |
| J5210B | Socket, 3/8" DR 5/16" 12 PT Black Oxide | J1214BASP | Wrench, Combination 7/16" 12 PT Black |
| J5014B | Socket, 3/8" DR 7/16" 12 PT Deep Black Oxide | J1216BASP | Wrench, Combination 1/2" 12 PT Black |
| J5016B | Socket, 3/8" DR 1/2" 12 PT Deep Black Oxide | J1218BASP | Wrench, Combination 9/16" 12 PT Black |
| J5018B | Socket, 3/8" DR 9/16" 12 PT Deep Black Oxide | J1220BASP | Wrench, Combination 5/8" 12 PT Black |
| J5020B | Socket, 3/8" DR 5/8" 12 PT Deep Black Oxide | J1222BASP | Wrench, Combination 11/16" 12 PT Black |
| J5022B | Socket, 3/8" DR 11/16" 12 PT Deep Black Oxide | J1224BASP | Wrench, Combination 3/4" 12 PT Black |
| J5024B | Socket, 3/8" DR 3/4" 12 PT Deep Black Oxide | J1226BASP | Wrench, Combination 13/16" 12 PT Black |
| J5414B | Socket, 1/2" DR 7/16" 12 PT Black Oxide | J1228BASP | Wrench, Combination 7/8" 12 PT Black |
| J5416B | Socket, 1/2" DR 1/2" 12 PT Black Oxide | J1230BASP | Wrench, Combination 15/16" 12 PT Black |
| J5418B | Socket, 1/2" DR 9/16" 12 PT Black Oxide | J1232BASP | Wrench, Combination 1" 12 PT Black |
| J5420B | Socket, 1/2" DR 5/8" 12 PT Black Oxide | J1234BASP | Wrench, Combination 1-1/16" 12 PT Black |
| J5422B | Socket, 1/2" DR 11/16" 12 PT Black Oxide | J1236BASP | Wrench, Combination 1-1/8" 12 PT Black |
| J5424B | Socket, 1/2" DR 3/4" 12 PT Black Oxide | J1240BASP | Wrench, Combination 1-1/4" 12 PT Black |
| J5426B | Socket, 1/2" DR 13/16" 12 PT Black Oxide | J1244B | Wrench, Combination 1-3/8" 12 PT Black |
| J5428B | Socket, 1/2" DR 7/8" 12 PT Black Oxide | J1246B | Wrench, Combination 1-7/16" 12 PT Black |
| J5430B | Socket, 1/2" DR 15/16" 12 PT Black Oxide | J1248B | Wrench, Combination 1-1/2" 12 PT Black |
| J5432B | Socket, 1/2" DR 1" 12 PT Black Oxide | J3812 | Wrench, Flare Nut Ratcheting 3/8" |
| J5434B | Socket, 1/2" DR 1-1/16" 12 PT Black Oxide | J3814 | Wrench, Flare Nut Ratcheting 7/16" |
| J5436B | Socket, 1/2" DR 1-1/8" 12 PT Black Oxide | J3816 | Wrench, Flare Nut Ratcheting 1/2" |
| J5440B | Socket, 1/2" DR 1-1/4" 12 PT Black Oxide | J3818 | Wrench, Flare Nut Ratcheting 9/16" |
| J5442B | Socket, 1/2" DR 1-5/16" 12 PT Black Oxide | J3820 | Wrench, Flare Nut Ratcheting 5/8" |
| J5444B | Socket, 1/2" DR 1-3/8" 12 PT Black Oxide | J3822 | Wrench, Flare Nut Ratcheting 11/16" |
| J5446B | Socket, 1/2" DR 1-7/16" 12 PT Black Oxide | J3824 | Wrench, Flare Nut Ratcheting 3/4" |
| J5448B | Socket, 1/2" DR 1-1/2" 12 PT Black Oxide | J1730 | Wrench, Obstruction 9/16" x 5/8" |
| J5316B | Socket, 1/2" DR 1/2" 12 PT Deep Black Oxide | J1731 | Wrench, Obstruction 5/8" x 3/4" |
| J5318B | Socket, 1/2" DR 9/16" 12 PT Deep Black Oxide | J810HD | Wrench, Pipe Heavy-Duty 10" |
| J5320B | Socket, 1/2" DR 5/8" 12 PT Deep Black Oxide | J818HD | Wrench, Pipe Heavy-Duty 18" |
| J5322B | Socket, 1/2" DR 11/16" 12 PT Deep Black Oxide | J1195-A | Wrench, Ratcheting Box 3/4" x 7/8" 12 PT |
| J5324B | Socket, 1/2" DR 3/4" 12 PT Deep Black Oxide | J1208EF | Wrench, Short Combination 1/4" 6 PT |
| J5326B | Socket, 1/2" DR 13/16" 12 PT Deep Black Oxide | J1209EF | Wrench, Short Combination 9/32" 6 PT |
| J5328B | Socket, 1/2" DR 7/8" 12 PT Deep Black Oxide | J1210EF | Wrench, Short Combination 5/16" 6 PT |
| | | J1211EF | Wrench, Short Combination 11/32" 6 PT |



172 PC RAILROAD ROADWAY WITH ROLLER CABINET J453441-7RD

Product #: **JTS-0172RRBX1**

- › 172 Pieces.
- › 1/2", 3/8" Drive Tools.
- › Designed for fastener sizes 1/4 - 1-1/2".
- › Enhanced version of Proto® J98100 Railroad Roadway Mechanic's Set.
- › Contains: 68 Sockets and Accessories, 54 Wrenches, 15 Striking and Struck Tools, 9 Pliers, 7 Screwdrivers, 19 Miscellaneous Tools.
- › Enhanced version of Proto® J98101 Railroad Roadway Mechanic's Set.
- › Weight: 390.0 lbs.



Representative Image; Contents May Differ

172 PC RAILROAD ROADWAY SET WITH ROLLER CABINET J442742-12RD

Product #: **JTS-0172RRBX2**

- › 172 Pieces.
- › 1/2", 3/8" Drive Tools.
- › Designed for fastener sizes 1/4" - 1-1/2".
- › Contains: 68 Sockets and Accessories, 54 Wrenches, 15 Striking and Struck Tools, 9 Pliers, 7 Screwdrivers, 19 Miscellaneous Tools.
- › Enhanced version of Proto® J98100 Railroad Roadway Mechanic's Set.
- › Weight: 291.0 lbs.



Representative Image; Contents May Differ



141 PC RAILROAD ELECTRICIAN'S SET

Product #: JTS-0141RR



- › 141 Pieces.
- › 1/4", 3/8", 1/2" Drive Tools.
- › Designed for fastener sizes 3/16" - 1-1/4".
- › Tools only.
- › Contains: 69 Sockets and Accessories, 27 Wrenches, 5 Striking and Struck Tools, 7 Pliers, 15 Screwdrivers, 18 Miscellaneous Tools.
- › Enhanced version of Proto® J98110 Railroad Electrician's Set.
- › Weight: 45.0 lbs.



Representative Image; Contents May Differ





| Contents | Description |
|-----------|---|
| J4770A | Adapter, Universal Joint 1/4" DR |
| J74470P | Adapter, Universal Joint 1/2" DR |
| J77270P | Adapter, Universal Joint 3/8" DR |
| J2116 | Bar, Pry Aligning 16" |
| J4769 | Driver, 1/4" DR |
| J4759 | Extension, 1/4" DR 2" |
| J4761 | Extension, 1/4" DR 6" |
| J5260B | Extension, 3/8" DR 3" Black |
| J5260-06B | Extension, 3/8" DR 6" Black |
| J5461B | Extension, 1/2" DR 5" Black |
| J5463B | Extension, 1/2" DR 10" Black |
| 20-001 | Stanley® Hacksaw, High Tension Low Profile 12" |
| J1312PD | Hammer, Ball Pein 12 oz. |
| J5468BL | Handle Hinge 1/2" DR 18-5/8" |
| J5265BL | Handle Hinge 3/8" DR 8-1/2" |
| J4980 | Hex Key, 13 PC Standard Set |
| J2108 | Holder, Punch and Chisel |
| 10-099 | Knife, Stanley® Classic 99® Retractable Blade Utility |
| J9206H | Nut Driver, 3/16" Hollow Shaft |
| J9208H | Nut Driver, 1/4" Hollow Shaft |
| J9210H | Nut Driver, 5/16" Hollow Shaft |
| J9211H | Nut Driver, 11/32" Hollow Shaft |
| J9212H | Nut Driver, 3/8" Hollow Shaft |
| J9214H | Nut Driver, 7/16" Hollow Shaft |
| J9216H | Nut Driver, 1/2" Hollow Shaft |
| J209G | Pliers, Diagonal Cutting with Grip 7-5/16" |
| J235 | Pliers, Ignition with Grip 4-1/16" |
| J267G | Pliers, Lineman's New England Style, 7-1/4" |
| J291NC | Pliers, Locking Straight 7" |
| J226G | Pliers, Needle-Nose with Cutter 6-5/8" |
| J260SG | Pliers, Tongue and Groove 10-3/16" with Grip |
| J299 | Pliers, Wire Stripper/Crimper 8-1/2" |
| J48116 | Punch Pin, 1/16" Super Duty |
| J48038 | Punch Pin, 3/8" Super Duty |
| J48532 | Punch Pin, 5/32" Super Duty |
| J5249BL | Ratchet, 3/8" DR Female |
| J4749BL | Ratchet, 1/4" DR Black |
| J5449BL | Ratchet, 1/2" DR Black |
| J9866 | Screw Starter, Double End |
| J88313 | Screwdriver, Phillips® #1 |
| J88324 | Screwdriver, Phillips® #2 |
| J88103 | Screwdriver, Slotted Keystone, Square 1/4" x 2" |
| J88104 | Screwdriver, Slotted Keystone, Square 1/4" x 4" |
| J88106 | Screwdriver, Slotted Keystone, Square 1/4" x 6" |
| J88108 | Screwdriver, Slotted Keystone, Square 1/4" x 8" |
| J88110 | Screwdriver, Slotted Keystone, Square 1/4" x 10" |
| J4706 | Socket, 1/4" DR 3/16" 6 PT |
| J4707 | Socket, 1/4" DR 7/32" 6 PT |
| J4708 | Socket, 1/4" DR 1/4" 6 PT |
| J4709 | Socket, 1/4" DR 9/32" 6 PT |
| J4710 | Socket, 1/4" DR 5/16" 6 PT |
| J4711 | Socket, 1/4" DR 11/32" 6 PT |
| J4712 | Socket, 1/4" DR 3/8" 6 PT |
| J4714 | Socket, 1/4" DR 7/16" 6 PT |
| J4716 | Socket, 1/4" DR 1/2" 6 PT |
| J4718 | Socket, 1/4" DR 9/16" 6 PT |
| J4706L | Socket, 1/4" DR 3/16" 6 PT Deep |
| J4707L | Socket, 1/4" DR 7/32" 6 PT Deep |

| Contents | Description |
|-----------|---|
| J4708L | Socket, 1/4" DR 1/4" 6 PT Deep |
| J4709L | Socket, 1/4" DR 9/32" 6 PT Deep |
| J4710L | Socket, 1/4" DR 5/16" 6 PT Deep |
| J4711L | Socket, 1/4" DR 11/32" 6 PT Deep |
| J4712L | Socket, 1/4" DR 3/8" 6 PT Deep |
| J4714L | Socket, 1/4" DR 7/16" 6 PT Deep |
| J4716L | Socket, 1/4" DR 1/2" 6 PT Deep |
| J4718L | Socket, 1/4" DR 9/16" 6 PT Deep |
| J5210B | Socket, 3/8" DR 5/16" 12 PT Black Oxide |
| J5212B | Socket, 3/8" DR 3/8" 12 PT Black Oxide |
| J5214B | Socket, 3/8" DR 7/16" 12 PT Black Oxide |
| J5216B | Socket, 3/8" DR 1/2" 12 PT Black Oxide |
| J5218B | Socket, 3/8" DR 9/16" 12 PT Black Oxide |
| J5220B | Socket, 3/8" DR 5/8" 12 PT Black Oxide |
| J5222B | Socket, 3/8" DR 11/16" 12 PT Black Oxide |
| J5224B | Socket, 3/8" DR 3/4" 12 PT Black Oxide |
| J5012B | Socket, 3/8" DR 3/8" 12 PT Deep Black Oxide |
| J5014B | Socket, 3/8" DR 7/16" 12 PT Deep Black Oxide |
| J5016B | Socket, 3/8" DR 1/2" 12 PT Deep Black Oxide |
| J5018B | Socket, 3/8" DR 9/16" 12 PT Deep Black Oxide |
| J5020B | Socket, 3/8" DR 5/8" 12 PT Deep Black Oxide |
| J5022B | Socket, 3/8" DR 11/16" 12 PT Deep Black Oxide |
| J5024B | Socket, 3/8" DR 3/4" 12 PT Deep Black Oxide |
| J5028B | Socket, 3/8" DR 7/8" 12 PT Deep Black Oxide |
| J5412B | Socket, 1/2" DR 3/8" 12 PT Black Oxide |
| J5414B | Socket, 1/2" DR 7/16" 12 PT Black Oxide |
| J5416B | Socket, 1/2" DR 1/2" 12 PT Black Oxide |
| J5418B | Socket, 1/2" DR 9/16" 12 PT Black Oxide |
| J5420B | Socket, 1/2" DR 5/8" 12 PT Black Oxide |
| J5422B | Socket, 1/2" DR 11/16" 12 PT Black Oxide |
| J5424B | Socket, 1/2" DR 3/4" 12 PT Black Oxide |
| J5426B | Socket, 1/2" DR 13/16" 12 PT Black Oxide |
| J5428B | Socket, 1/2" DR 7/8" 12 PT Black Oxide |
| J5430B | Socket, 1/2" DR 15/16" 12 PT Black Oxide |
| J5432B | Socket, 1/2" DR 1" 12 PT Black Oxide |
| J5434B | Socket, 1/2" DR 1-1/16" 12 PT Black Oxide |
| J5436B | Socket, 1/2" DR 1-1/8" 12 PT Black Oxide |
| J5440B | Socket, 1/2" DR 1-1/4" 12 PT Black Oxide |
| J5273A | Socket, Universal 3/8" DR 3/8" 12 PT |
| J5274A | Socket, Universal 3/8" DR 7/16" 12 PT |
| J5275A | Socket, Universal 3/8" DR 1/2" 12 PT |
| J5276A | Socket, Universal 3/8" DR 9/16" 12 PT |
| 33-725 | Tape Rule, FatMax® 1-1/4" x 25' |
| J706SL | Wrench, Adjustable Clik-Stop® 6" |
| J708SL | Wrench, Adjustable Clik-Stop® 8" |
| J3210 | Wrench, Angle 13/64" x 15/64" Short |
| J3215 | Wrench, Angle 7/32" x 1/4" Short |
| J3211 | Wrench, Angle 15/64" x 13/64" Short |
| J3216 | Wrench, Angle 1/4" x 7/32" Short |
| J3220 | Wrench, Angle 9/32" x 5/16" Short |
| J3221 | Wrench, Angle 5/16" x 9/32" Short |
| J3225 | Wrench, Angle 11/32" x 3/8" Short |
| J3226 | Wrench, Angle 3/8" x 11/32" Short |
| J1212BASD | Wrench, Combination 3/8" 12 PT Black |
| J1214BASD | Wrench, Combination 7/16" 12 PT Black |
| J1216BASD | Wrench, Combination 1/2" 12 PT Black |
| J1218BASD | Wrench, Combination 9/16" 12 PT Black |
| J1220BASD | Wrench, Combination 5/8" 12 PT Black |

(CONTINUED ON NEXT PAGE)

141 PC RAILROAD ELECTRICIAN'S SET (CONTINUED)

Product #: **JTS-0141RR**



| Contents | Description |
|-----------|--|
| J1222BASP | Wrench, Combination 11/16" 12 PT Black |
| J1224BASP | Wrench, Combination 3/4" 12 PT Black |
| J1226BASP | Wrench, Combination 13/16" 12 PT Black |
| J1228BASP | Wrench, Combination 7/8" 12 PT Black |
| J1230BASP | Wrench, Combination 15/16" 12 PT Black |
| J1232BASP | Wrench, Combination 1" 12 PT Black |

| Contents | Description |
|-----------|--|
| J1234BASP | Wrench, Combination 1-1/16" 12 PT Black |
| J1236BASP | Wrench, Combination 1-1/8" 12 PT Black |
| J1240BASP | Wrench, Combination 1-1/4" 12 PT Black |
| J1192-A | Wrench, Ratcheting Box 3/8" x 7/16" 6 PT |
| J1193-A | Wrench, Ratcheting Box 1/2" x 9/16" 6 PT |
| J1195-A | Wrench, Ratcheting Box 3/4" x 7/8" 12 PT |

141 PC RAILROAD ELECTRICIAN'S SET WITH TOOL BOX J9969-NA

Product #: **JTS-0141RRBX1**



- › 141 Pieces.
- › 1/4", 3/8", 1/2" Drive Tools.
- › Designed for fastener sizes 3/16" - 1-1/4".
- › Contains: 69 Sockets and Accessories, 27 Wrenches, 5 Striking and Struck Tools, 7 Pliers, 15 Screwdrivers, 18 Miscellaneous Tools.
- › Enhanced version of Proto® J98111 Railroad Electrician's Set.
- › Weight: 65.0 lbs.



Representative Image; Contents May Differ



107 PC RAILROAD PIPE FITTER'S SET

Product #: JTS-0107RR

- › 107 Pieces.
- › 3/8", 1/2" Drive Tools.
- › Designed for fastener sizes 3/8" - 1-1/4".
- › Tools only.
- › Contains: 45 Sockets and Accessories, 25 Wrenches, 9 Striking and Struck Tools, 6 Pliers, 5 Screwdrivers, 17 Miscellaneous Tools.
- › Enhanced version of Proto® J98130 Railroad Pipe Fitter's Set.
- › Weight: 55.0 lbs.



Representative Image; Contents May Differ

| Contents | Description |
|-----------|--|
| J5270A | Adapter, Universal Joint 3/8" DR |
| J5470A | Adapter, Universal Joint 1/2" DR |
| J2130 | Bar, 16" Long 5/8" Tip |
| J721/4 | Chisel, Cape 11/64 |
| J86038 | Chisel, Cold 3/8" Super Duty |
| J86034 | Chisel, Cold 3/4" Super Duty |
| J5461B | Extension, 1/2" DR 5" Black |
| J5463B | Extension, 1/2" DR 10" Black |
| J5260B | Extension, 3/8" DR 3" Black |
| J5260-06B | Extension, 3/8" DR 6" Black |
| J5262B | Extension, 3/8" DR 12" Black |
| J7181P | Extension, Impact 1/2" DR 5" |
| J7183-00 | Extension, Impact 1/2" DR 10" |
| 20-001 | Stanley® Hacksaw, High Tension Low Profile 12" |
| J1316PD | Hammer, Ball Pein 16 oz. |
| J4993 | Hex Key, 9 PC Folding Set |
| J2108 | Holder, Punch and Chisel |
| 43-511 | Level, Shock-Resistant Magnetic Torpedo - 9" |

| Contents | Description |
|----------|---|
| J2373 | Mirror, Rectangular Telescoping 2-1/8" |
| J209G | Pliers, Diagonal Cutting with Grip 7-5/16" |
| J292NC | Pliers, Locking Curved 10" |
| J226G | Pliers, Needle-Nose with Cutter 6-5/8" |
| J278G | Pliers, Slip-Joint with Grip 8-1/16" |
| J260SG | Pliers, Tongue and Groove 10-3/16" with Grip |
| J411/4 | Punch, Center |
| J48018 | Punch, Pin 1/8" Super Duty |
| J48316 | Punch, Pin 3/16" Super Duty |
| J48038 | Punch, Pin 3/8" Super Duty |
| J5249BL | Ratchet, 3/8" DR Female |
| J5449BL | Ratchet, 1/2" DR Black |
| J5450BL | Ratchet, 1/2" DR Black |
| J2377 | Retriever, Magnetic |
| J2336 | Scrapers, Gasket and Carbon |
| J88324 | Screwdriver, Phillips® #2 |
| J88102 | Screwdriver, Slotted Keystone, Square 1/4" x 2" |
| J88104 | Screwdriver, Slotted Keystone, Square 1/4" x 4" |

(CONTINUED ON NEXT PAGE)

107 PC RAILROAD PIPE FITTER'S SET (CONTINUED)

Product #: **JTS-0107RR**



| Contents | Description |
|----------|---|
| J88106 | Screwdriver, Slotted Keystone, Square 1/4" x 6" |
| J88108 | Screwdriver, Slotted Keystone, Square 1/4" x 8" |
| J303S | Snips, Aviation Straight |
| J5412B | Socket, 1/2" DR 3/8" 12 PT Black Oxide |
| J5414B | Socket, 1/2" DR 7/16" 12 PT Black Oxide |
| J5416B | Socket, 1/2" DR 1/2" 12 PT Black Oxide |
| J5418B | Socket, 1/2" DR 9/16" 12 PT Black Oxide |
| J5420B | Socket, 1/2" DR 5/8" 12 PT Black Oxide |
| J5422B | Socket, 1/2" DR 11/16" 12 PT Black Oxide |
| J5424B | Socket, 1/2" DR 3/4" 12 PT Black Oxide |
| J5426B | Socket, 1/2" DR 13/16" 12 PT Black Oxide |
| J5428B | Socket, 1/2" DR 7/8" 12 PT Black Oxide |
| J5430B | Socket, 1/2" DR 15/16" 12 PT Black Oxide |
| J5432B | Socket, 1/2" DR 1" 12 PT Black Oxide |
| J5434B | Socket, 1/2" DR 1-1/16" 12 PT Black Oxide |
| J5436B | Socket, 1/2" DR 1-1/8" 12 PT Black Oxide |
| J5438B | Socket, 1/2" DR 1-3/16" 12 PT Black Oxide |
| J5440B | Socket, 1/2" DR 1-1/4" 12 PT Black Oxide |
| J5212B | Socket, 3/8" DR 3/8" 12 PT Black Oxide |
| J5214B | Socket, 3/8" DR 7/16" 12 PT Black Oxide |
| J5216B | Socket, 3/8" DR 1/2" 12 PT Black Oxide |
| J5218B | Socket, 3/8" DR 9/16" 12 PT Black Oxide |
| J5220B | Socket, 3/8" DR 5/8" 12 PT Black Oxide |
| J5222B | Socket, 3/8" DR 11/16" 12 PT Black Oxide |
| J5224B | Socket, 3/8" DR 3/4" 12 PT Black Oxide |
| J5012B | Socket, 3/8" DR 3/8" 12 PT Deep Black Oxide |
| J5014B | Socket, 3/8" DR 7/16" 12 PT Deep Black Oxide |
| J5016B | Socket, 3/8" DR 1/2" 12 PT Deep Black Oxide |
| J5018B | Socket, 3/8" DR 9/16" 12 PT Deep Black Oxide |
| J5020B | Socket, 3/8" DR 5/8" 12 PT Deep Black Oxide |
| J5022B | Socket, 3/8" DR 11/16" 12 PT Deep Black Oxide |

| Contents | Description |
|-----------|---|
| J5024B | Socket, 3/8" DR 3/4" 12 PT Deep Black Oxide |
| J5028B | Socket, 3/8" DR 7/8" 12 PT Deep Black Oxide |
| J5240A | Socket, Bit 3/8" DR Slotted |
| J7424H | Socket, Impact 1/2" DR 3/4" 6 PT |
| J7651 | Socket, Impact Adapter 1/2"F x 3/8" M |
| 33-116 | Tape Rule, PowerLock® 3/4" x 16" |
| J710SL | Wrench, Adjustable Clik-Stop® 1" |
| J706SL | Wrench, Adjustable Clik-Stop® 6" |
| J708SL | Wrench, Adjustable Clik-Stop® 8" |
| J801 | Wrench, Chain |
| J1212BASD | Wrench, Combination 3/8" 12 PT Black |
| J1214BASD | Wrench, Combination 7/16" 12 PT Black |
| J1216BASD | Wrench, Combination 1/2" 12 PT Black |
| J1218BASD | Wrench, Combination 9/16" 12 PT Black |
| J1220BASD | Wrench, Combination 5/8" 12 PT Black |
| J1222BASD | Wrench, Combination 11/16" 12 PT Black |
| J1224BASD | Wrench, Combination 3/4" 12 PT Black |
| J1226BASD | Wrench, Combination 13/16" 12 PT Black |
| J1228BASD | Wrench, Combination 7/8" 12 PT Black |
| J1230BASD | Wrench, Combination 15/16" 12 PT Black |
| J1232BASD | Wrench, Combination 1" 12 PT Black |
| J1234BASD | Wrench, Combination 1-1/16" 12 PT Black |
| J1236BASD | Wrench, Combination 1-1/8" 12 PT Black |
| J1240BASD | Wrench, Combination 1-1/4" 12 PT Black |
| J1725 | Wrench, Obstruction 7/16" x 1/2" |
| J1731 | Wrench, Obstruction 5/8" x 3/4" |
| J818HD | Wrench, Pipe Heavy-Duty 18" |
| J1192T-A | Wrench, Ratcheting Box 3/8" x 7/16" 12 PT |
| J1193T-A | Wrench, Ratcheting Box 1/2" x 9/16" 12 PT |
| J1194-A | Wrench, Ratcheting Box 5/8" x 11/16" 12 PT |
| J1195-A | Wrench, Ratcheting Box 3/4" x 7/8" 12 PT |

107 PC RAILROAD PIPE FITTER'S SET WITH TOOL BOX J9969-NA

Product #: **JTS-0107RRBX1**



- ▶ 107 Pieces.
- ▶ 3/8", 1/2" Drive Tools.
- ▶ Designed for fastener sizes 3/8" - 1-1/4".
- ▶ Contains: 46 Sockets and Accessories, 25 Wrenches, 8 Striking and Struck Tools, 7 Pliers, 5 Screwdrivers, 16 Miscellaneous Tools.
- ▶ Enhanced version of Proto® J98131 Railroad Pipe Fitter's Set.
- ▶ Weight: 74.0 lbs.



Representative Image; Contents May Differ



89 PC RAILROAD MACHINIST'S SET

Product #: JTS-0089RR



- › 89 Pieces.
- › 3/8", 1/2" Drive Tools.
- › Designed for fastener sizes 3/8" - 1-1/4".
- › Tools only.
- › Contains: 36 Sockets and Accessories, 18 Wrenches, 8 Striking and Struck Tools, 4 Pliers, 6 Screwdrivers, 17 Miscellaneous Tools.
- › Enhanced version of Proto® J98120 Railroad Machinist's Set.
- › Weight: 40.0 lbs.



Representative Image; Contents May Differ

| Contents | Description |
|-----------|--|
| J74470P | Adapter, Universal Joint 1/2" DR |
| J2130 | Bar, 16" Long 5/8" Tip |
| J721/4 | Chisel, Cape 11/64" |
| J86012 | Chisel, Cold 1/2" Super Duty |
| J000AA | Feeler Gauge, 25 Blade Master Set |
| J5260B | Extension, 3/8" DR 3" Black |
| J5260-06B | Extension, 3/8" DR 6" Black |
| J5461B | Extension, 1/2" DR 5" Black |
| J5463B | Extension, 1/2" DR 10" Black |
| 20-001 | Stanley® Hacksaw, High Tension Low Profile 12" |
| J1324PD | Hammer, Ball Pein 24 oz. |
| J5265BL | Handle, Hinge 3/8" DR 8-1/2" |
| J5468BL | Handle, Hinge 1/2" DR 18-5/8" |
| J4980 | Hex Key, 13 PC Standard Set |
| J2108 | Holder, Punch and Chisel |
| J209G | Pliers, Diagonal Cutting with Grip 7-5/16" |
| J291NC | Pliers, Locking Straight 7" |
| J278G | Pliers, Slip-Joint with Grip 8-1/16" |
| J260SG | Pliers, Tongue and Groove 10-3/16" with Grip |
| J48116 | Punch, Pin, 1/16" Super Duty |
| J48018 | Punch, Pin, 1/8" Super Duty |

| Contents | Description |
|----------|--|
| J48532 | Punch, Pin, 5/32" Super Duty |
| J48038 | Punch, Pin, 3/8" Super Duty |
| J5249BL | Ratchet, 3/8" DR Female |
| J5449BL | Ratchet, 1/2" DR Black |
| J2336 | Scrapers, Gasket and Carbon |
| J88336B | Screwdriver Phillips® #3 x 6" |
| J88348 | Screwdriver, Phillips® #4 |
| J88102 | Screwdriver, Slotted Keystone, Square 1/4" x 2" |
| J88106 | Screwdriver, Slotted Keystone, Square 1/4" x 6" |
| J88108 | Screwdriver, Slotted Keystone, Square 1/4" x 8" |
| J88110 | Screwdriver, Slotted Keystone, Square 1/4" x 10" |
| J5210B | Socket, 3/8" DR 5/16" 12 PT Black Oxide |
| J5212B | Socket, 3/8" DR 3/8" 12 PT Black Oxide |
| J5214B | Socket, 3/8" DR 7/16" 12 PT Black Oxide |
| J5216B | Socket, 3/8" DR 1/2" 12 PT Black Oxide |
| J5218B | Socket, 3/8" DR 9/16" 12 PT Black Oxide |
| J5220B | Socket, 3/8" DR 5/8" 12 PT Black Oxide |
| J5222B | Socket, 3/8" DR 11/16" 12 PT Black Oxide |
| J5224B | Socket, 3/8" DR 3/4" 12 PT Black Oxide |
| J5012B | Socket, 3/8" DR 3/8" 12 PT Deep Black Oxide |
| J5022B | Socket, 3/8" DR 11/16" 12 PT Deep Black Oxide |

(CONTINUED ON NEXT PAGE)

89 PC RAILROAD MACHINIST'S SET (CONTINUED)

Product #: **JTS-0089RR**



| Contents | Description |
|----------|---|
| J5412B | Socket, 1/2" DR 3/8" 12 PT Black Oxide |
| J5414B | Socket, 1/2" DR 7/16" 12 PT Black Oxide |
| J5416B | Socket, 1/2" DR 1/2" 12 PT Black Oxide |
| J5418B | Socket, 1/2" DR 9/16" 12 PT Black Oxide |
| J5420B | Socket, 1/2" DR 5/8" 12 PT Black Oxide |
| J5422B | Socket, 1/2" DR 11/16" 12 PT Black Oxide |
| J5430B | Socket, 1/2" DR 15/16" 12 PT Black Oxide |
| J5424B | Socket, 1/2" DR 3/4" 12 PT Black Oxide |
| J5428B | Socket, 1/2" DR 7/8" 12 PT Black Oxide |
| J5432B | Socket, 1/2" DR 1" 12 PT Black Oxide |
| J5434B | Socket, 1/2" DR 1-1/16" 12 PT Black Oxide |
| J5436B | Socket, 1/2" DR 1-1/8" 12 PT Black Oxide |
| J5440B | Socket, 1/2" DR 1-1/4" 12 PT Black Oxide |
| J5273A | Socket, Universal 3/8" DR 3/8" 12 PT |
| J5274A | Socket, Universal 3/8" DR 7/16" 12 PT |
| J5275A | Socket, Universal 3/8" DR 1/2" 12 PT |
| J5276A | Socket, Universal 3/8" DR 9/16" 12 PT |
| J712SL | Wrench, Adjustable Klik-Stop® 1" |

| Contents | Description |
|-----------|--|
| J708SL | Wrench, Adjustable Klik-Stop® 8" |
| J1212BASD | Wrench, Combination 3/8" 12 PT Black |
| J1214BASD | Wrench, Combination 7/16" 12 PT Black |
| J1216BASD | Wrench, Combination 1/2" 12 PT Black |
| J1218BASD | Wrench, Combination 9/16" 12 PT Black |
| J1220BASD | Wrench, Combination 5/8" 12 PT Black |
| J1222BASD | Wrench, Combination 11/16" 12 PT Black |
| J1224BASD | Wrench, Combination 3/4" 12 PT Black |
| J1226BASD | Wrench, Combination 13/16" 12 PT Black |
| J1228BASD | Wrench, Combination 7/8" 12 PT Black |
| J1230BASD | Wrench, Combination 15/16" 12 PT Black |
| J1232BASD | Wrench, Combination 1" 12 PT Black |
| J1234BASD | Wrench, Combination 1-1/16" 12 PT Black |
| J1236BASD | Wrench, Combination 1-1/8" 12 PT Black |
| J1240BASD | Wrench, Combination 1-1/4" 12 PT Black |
| J1193-A | Wrench, Ratcheting Box 1/2" x 9/16" 6 PT |
| J1195-A | Wrench, Ratcheting Box 3/4" x 7/8" 12 PT |

89 PC RAILROAD MACHINIST'S SET WITH TOOL BOX J9969-NA

Product #: **JTS-0089RRBX1**



- ▶ 89 Pieces.
- ▶ 3/8", 1/2" Drive Tools.
- ▶ Designed for fastener sizes 3/8" - 1-1/4".
- ▶ Contains: 36 Sockets and Accessories, 18 Wrenches, 7 Striking and Struck Tools, 5 Pliers, 6 Screwdrivers, and 17 Miscellaneous Tools.
- ▶ Enhanced version of Proto® J98121 Railroad Machinist's Set.
- ▶ Weight: 59.0 lbs.



Representative Image; Contents May Differ



67 PC RAILROAD CARMAN'S SET

Product #: JTS-0067RR



- › 67 Pieces.
- › 1/2" Drive Tools.
- › Designed for fastener sizes 7/16" - 1-1/4".
- › Tools only.
- › Contains: 17 Sockets and Accessories, 16 Wrenches, 7 Striking and Struck Tools, 3 Pliers, 8 Screwdrivers, 16 Miscellaneous Tools.
- › Enhanced version of Proto® J98140 Railroad Carman's Set.
- › Weight: 41.0 lbs.



Representative Image; Contents May Differ

| Contents | Description |
|----------|--|
| J2116 | Bar, Pry Aligning 16" |
| J2130 | Bar, 16" Long 5/8" Tip |
| J721/4 | Chisel, Cape 11/64" |
| J86001 | Chisel, Cold 1" Super Duty |
| J5461B | Extension, 1/2" DR 5" Black |
| J1332PD | Hammer, Ball Pein 32 oz. |
| J5468BL | Handle Hinge 1/2" DR 18-5/8" |
| 51-616 | Hammer, Hickory Handle Nailing - 16 oz. |
| J2108 | Holder, Punch and Chisel |
| J4978 | Hex Key, 9 PC Folding Set |
| 43-511 | Level, Shock-Resistant Magnetic Torpedo - 9" |
| J210G | Pliers, Diagonal Cutting with Grip 8-1/2" |
| J226G | Pliers, Needle-Nose with Cutter 6-5/8" |
| J260SG | Pliers, Tongue and Groove 10-3/16" with Grip |
| J2306 | Puller, Cotter Pin Tool |

| Contents | Description |
|----------|--|
| J411/2 | Punch, Center 1/2" |
| J961/2 | Punch, Drift 1/4" |
| J5449BL | Ratchet, 1/2" DR Black |
| J2336 | Scrapers, Gasket and Carbon |
| J88313 | Screwdriver, Phillips® #1 |
| J88324 | Screwdriver, Phillips® #2 |
| J88336 | Screwdriver, Phillips® #3 |
| J88348 | Screwdriver, Phillips® #4 |
| J88102 | Screwdriver, Slotted Keystone, Square 1/4" x 2" |
| J88106 | Screwdriver, Slotted Keystone, Square 1/4" x 6" |
| J88108 | Screwdriver, Slotted Keystone, Square 1/4" x 8" |
| J88110 | Screwdriver, Slotted Keystone, Square 1/4" x 10" |
| J5414B | Socket, 1/2" DR 7/16" 12 PT Black Oxide |
| J5416B | Socket, 1/2" DR 1/2" 12 PT Black Oxide |
| J5418B | Socket, 1/2" DR 9/16" 12 PT Black Oxide |

(CONTINUED ON NEXT PAGE)



67 PC RAILROAD CARMAN'S SET (CONTINUED)

Product #: **JTS-0067RR**



| Contents | Description | Contents | Description |
|----------|---|-----------|---|
| J5420B | Socket, 1/2" DR 5/8" 12 PT Black Oxide | J1212BASD | Wrench, Combination 3/8" 12 PT Black |
| J5422B | Socket, 1/2" DR 11/16" 12 PT Black Oxide | J1214BASD | Wrench, Combination 7/16" 12 PT Black |
| J5424B | Socket, 1/2" DR 3/4" 12 PT Black Oxide | J1216BASD | Wrench, Combination 1/2" 12 PT Black |
| J5426B | Socket, 1/2" DR 13/16" 12 PT Black Oxide | J1218BASD | Wrench, Combination 9/16" 12 PT Black |
| J5428B | Socket, 1/2" DR 7/8" 12 PT Black Oxide | J1220BASD | Wrench, Combination 5/8" 12 PT Black |
| J5430B | Socket, 1/2" DR 15/16" 12 PT Black Oxide | J1222BASD | Wrench, Combination 11/16" 12 PT Black |
| J5432B | Socket, 1/2" DR 1" 12 PT Black Oxide | J1224BASD | Wrench, Combination 3/4" 12 PT Black |
| J5436B | Socket, 1/2" DR 1-1/8" 12 PT Black Oxide | J1226BASD | Wrench, Combination 13/16" 12 PT Black |
| J5318B | Socket, 1/2" DR 9/16" 12 PT Deep Black Oxide | J1228BASD | Wrench, Combination 7/8" 12 PT Black |
| J5330B | Socket, 1/2" DR 15/16" 12 PT Deep Black Oxide | J1230BASD | Wrench, Combination 15/16" 12 PT Black |
| J5332B | Socket, 1/2" DR 1" 12 PT Deep Black Oxide | J1232BASD | Wrench, Combination 1" 12 PT Black |
| 46-222 | Square, 12" Die-Cast Combination | J1234BASD | Wrench, Combination 1-1/16" 12 PT Black |
| 33-725 | Tape Rule, FatMax® 1-1/4" x 25' | J1236BASD | Wrench, Combination 1-1/8" 12 PT Black |
| J712SL | Wrench, Adjustable Klik-Stop® 1" | J1240BASD | Wrench, Combination 1-1/4" 12 PT Black |
| J812HD | Wrench, Pipe 12" | | |

67 PC RAILROAD CARMAN'S SET WITH TOOL BOX J9969-NA

Product #: **JTS-0067RRBX1**



- ▶ 67 Pieces.
- ▶ 1/2" Drive Tools.
- ▶ Designed for fastener sizes 7/16" - 1-1/4".
- ▶ Contains: 17 Sockets and Accessories, 16 Wrenches, 6 Striking and Struck Tools, 4 Pliers, 8 Screwdrivers, 16 Miscellaneous Tools.
- ▶ Enhanced version of Proto® J98141 Railroad Carman's Set.
- ▶ Weight: 61.0 lbs.



Representative Image; Contents May Differ



105 PC BASIC TOOL SET

Product #: JTS-0105HVAC

- › 105 Pieces.
- › 3/8" Drive Tools.
- › Designed for fastener sizes 3/8" - 7/8".
- › Contains: 28 Sockets and Accessories, 26 Wrenches, 7 Striking and Struck Tools, 8 Pliers, 13 Screwdrivers, 23 Miscellaneous Tools.
- › Weight: 40.36.0 lbs.



Representative Image; Contents May Differ

| Contents | Description |
|----------|--|
| J5270A | Adapter, Universal Joint 3/8" DR |
| J86012 | Chisel, Cold 1/2" Super Duty |
| J86058 | Chisel, Cold 5/8" Super Duty |
| J5259 | Extension, 3/8" DR 1-3/4" |
| J5260 | Extension, 3/8" DR 3" |
| J5260-06 | Extension, 3/8" DR 6" |
| 20-001 | Stanley® Hacksaw, High Tension Low Profile 12" |
| 15-809 | Stanley® Hacksaw, Metal Mini |
| 54-016 | Stanley® Hammer, Ball Pein Hickory 16 oz. |
| J4980 | Hex Key, 13 PC Standard Set |
| J2108 | Holder, Punch and Chisel |
| 10-788 | Knife, QuickChange™ Retractable Blade Utility |
| 43-609 | Level, FatMax® Xtreme™ Torpedo 9" |
| J2370 | Mirror, Inspect Circle 7/8" |
| J9206H | Nut Driver, 3/16" Hollow Shaft |
| J9208H | Nut Driver, 1/4" Hollow Shaft |
| J9210H | Nut Driver, 5/16" Hollow Shaft |
| J9212H | Nut Driver, 3/8" Hollow Shaft |

| Contents | Description |
|----------|--|
| J9216H | Nut Driver, 1/2" Hollow Shaft |
| J207G | Pliers, Diagonal Cutting with Grip 7-5/16" |
| J252G | Pliers, Hose Clamp with Grip 7-3/4" |
| J291NC | Pliers, Locking Straight 7" |
| J228G | Pliers, Needle-Nose Long Handle 7-25/32" |
| J240G | Pliers, Needle-Nose Long Reach 11-9/16" |
| J276G | Pliers, Slip-Joint with Grip 6-9/16" |
| J260SG | Pliers, Tongue and Groove 10-3/16" with Grip |
| J299 | Pliers, Wire Stripper/Crimper 8-1/2" |
| J4029 | Puller Set Box |
| J413/8 | Punch, Center 3/8" |
| J48018 | Punch, Pin 1/8" Super Duty |
| J48316 | Punch, Pin 3/16" Super Duty |
| J5249 | Ratchet, 3/8" DR |
| 28-240 | Scraper, Flexible Nylon 1-1/4" |
| 66-095 | Screwdriver, Vinyl Grip |
| 65-903 | Screwdriver, Vinyl Grip Phillips® 3 PT x 3" |
| 66-565P | Screwdriver, 6 PC Stanley® Vinyl Grip |

(CONTINUED ON NEXT PAGE)

105 PC BASIC TOOL SET (CONTINUED)

Product #: **JTS-0105HVAC**



| Contents | Description |
|----------|--------------------------------------|
| J5212 | Socket, 3/8" DR 3/8" 12 PT |
| J5214 | Socket, 3/8" DR 7/16" 12 PT |
| J5216 | Socket, 3/8" DR 1/2" 12 PT |
| J5218 | Socket, 3/8" DR 9/16" 12 PT |
| J5220 | Socket, 3/8" DR 5/8" 12 PT |
| J5222 | Socket, 3/8" DR 11/16" 12 PT |
| J5224 | Socket, 3/8" DR 3/4" 12 PT |
| J5226 | Socket, 3/8" DR 13/16" 12 PT |
| J5228 | Socket, 3/8" DR 7/8" 12 PT |
| J5012 | Socket, 3/8" DR 3/8" 12 PT Deep |
| J5014 | Socket, 3/8" DR 7/16" 12 PT Deep |
| J5016 | Socket, 3/8" DR 1/2" 12 PT Deep |
| J5018 | Socket, 3/8" DR 9/16" 12 PT Deep |
| J5020 | Socket, 3/8" DR 5/8" 12 PT Deep |
| J5022 | Socket, 3/8" DR 11/16" 12 PT Deep |
| J5024 | Socket, 3/8" DR 3/4" 12 PT Deep |
| J5026 | Socket, 3/8" DR 13/16" 12 PT Deep |
| J5028 | Socket, 3/8" DR 7/8" 12 PT Deep |
| J7210PF | Socket, Power 3/8" DR 5/16" Magnetic |
| J7212PF | Socket, Power 3/8" DR 3/8" Magnetic |
| J7214PF | Socket, Power 3/8" DR 7/16" Magnetic |
| J7216PF | Socket, Power 3/8" DR 1/2" Magnetic |
| J7218PF | Socket, Power 3/8" DR 9/16" Magnetic |
| 33-725 | Tape Rule, FatMax® 1-1/4" x 25' |
| 518160M | Tote, Stanley® FatMax® 18" |
| J350 | Tubing Cutter |
| J351 | Tubing Flaring Tool |
| J708G | Wrench, Adjustable 8" Grip |

| Contents | Description |
|----------|---|
| J712G | Wrench, Adjustable 12" Grip |
| J812HD | Wrench, Pipe 12" |
| J1111 | Wrench, Ratchet Refrigeration, 1/4" - 3/16" Sq. x 9/16" |
| J1112 | Wrench, Ratchet Refrigeration, 3/8" - 5/16" Sq. x 1/4" |
| J1208A | Wrench, Combination 1/4" 12 PT |
| J1210A | Wrench, Combination 5/16" 12 PT |
| J1212ASD | Wrench, Combination 3/8" 12 PT |
| J1214ASD | Wrench, Combination 7/16" 12 PT |
| J1216ASD | Wrench, Combination 1/2" 12 PT |
| J1218ASD | Wrench, Combination 9/16" 12 PT |
| J1220ASD | Wrench, Combination 5/8" 12 PT |
| J1222ASD | Wrench, Combination 11/16" 12 PT |
| J1224ASD | Wrench, Combination 3/4" 12 PT |
| J1226ASD | Wrench, Combination 13/16" 12 PT |
| J1228ASD | Wrench, Combination 7/8" 12 PT |
| J3764 | Wrench, Flare Nut 3/8" x 7/16" 6 PT |
| J3768 | Wrench, Flare Nut 1/2" x 9/16" 6 PT |
| J3772 | Wrench, Flare Nut 5/8" x 11/16" 6 PT |
| J3812 | Wrench, Flare Nut Ratcheting 3/8" |
| J3814 | Wrench, Flare Nut Ratcheting 7/16" |
| J3816 | Wrench, Flare Nut Ratcheting 1/2" |
| J3818 | Wrench, Flare Nut Ratcheting 9/16" |
| J3820 | Wrench, Flare Nut Ratcheting 5/8" |
| J3822 | Wrench, Flare Nut Ratcheting 11/16" |
| J3824 | Wrench, Flare Nut Ratcheting 3/4" |



70 PC STARTER TOOL SET

Product #: **JTS-0070HVAC**



- › 70 Pieces.
- › Contains: 19 Wrenches, 7 Striking and Struck Tools, 8 Pliers, 12 Screwdrivers, 24 Miscellaneous Tools.
- › Weight: 45.0 lbs.



Representative Image; Contents May Differ

| Contents | Description | Contents | Description |
|----------|--|----------|--|
| J86012 | Chisel, Cold 1/2" Super Duty | 66-095 | Screwdriver, Vinyl Grip |
| J86058 | Chisel, Cold 5/8" Super Duty | 65-903 | Screwdriver, Vinyl Grip Phillips® 3 PT x 3" |
| 20-001 | Stanley® Hacksaw, High Tension Low Profile 12" | 66-565P | Screwdriver, 6 PC Stanley® Vinyl Grip |
| 15-809 | Stanley® Hacksaw, Metal Mini | 33-725 | Tape Rule, FatMax® 1-1/4" x 25' |
| 54-016 | Stanley® Hammer, Ball Pein Hickory 16 oz. | 518160M | Tote, Stanley® FatMax® 18" |
| J4980 | Hex Key, 13 PC Standard Set | J350 | Tubing Cutter |
| J2108 | Holder, Punch and Chisel | J351 | Tubing Flaring Tool |
| 10-788 | Knife, Utility QuickChange™ Retractable Blade | J708G | Wrench, Adjustable, 8" Grip |
| 43-609 | Level, FatMax® Xtreme™ Torpedo 9" | J712G | Wrench, Adjustable, 12" Grip |
| J2370 | Mirror, Inspect Circle 7/8" | J1208A | Wrench, Combination 1/4" 12 PT |
| J9208H | Nut Driver, 1/4" Hollow Shaft | J1210A | Wrench, Combination 5/16" 12 PT |
| J9210H | Nut Driver, 5/16" Hollow Shaft | J1212ASD | Wrench, Combination 3/8" 12 PT |
| J9212H | Nut Driver, 3/8" Hollow Shaft | J1214ASD | Wrench, Combination 7/16" 12 PT |
| J9216H | Nut Driver, 1/2" Hollow Shaft | J1216ASD | Wrench, Combination 1/2" 12 PT |
| J207G | Pliers, Diagonal Cutting with Grip 7-5/16" | J1218ASD | Wrench, Combination 9/16" 12 PT |
| J252G | Pliers, Hose Clamp with Grip 7-3/4" | J1220ASD | Wrench, Combination 5/8" 12 PT |
| J291NC | Pliers, Locking Straight 7" | J1222ASD | Wrench, Combination 11/16" 12 PT |
| J228G | Pliers, Needle-Nose Long Handle 7-25/32" | J1224ASD | Wrench, Combination 3/4" 12 PT |
| J240G | Pliers, Needle-Nose Long Reach 11-9/16" | J1226ASD | Wrench, Combination 13/16" 12 PT |
| J276G | Pliers, Slip-Joint with Grip 6-9/16" | J1228ASD | Wrench, Combination 7/8" 12 PT |
| J260SG | Pliers, Tongue and Groove 10-3/16" with Grip | J3764 | Wrench, Flare Nut 3/8" x 7/16" 6 PT |
| J299 | Pliers, Wire Stripper/Crimper 8-1/2" | J3768 | Wrench, Flare Nut 1/2" x 9/16" 6 PT |
| J4029 | Puller Set Box | J3772 | Wrench, Flare Nut 5/8" x 11/16" 6 PT |
| J413/8 | Punch, Center 3/8" | J812HD | Wrench, Pipe 12" |
| J48018 | Punch, Pin 1/8" Super Duty | J1111 | Wrench, Ratchet Refrigeration, 1/4" - 3/16" Sq. x 9/16 |
| J48316 | Punch, Pin 3/16" Super Duty | J1112 | Wrench, Ratchet Refrigeration, 3/8" - 5/16" Sq. x 1/4 |
| 28-240 | Scraper, Flexible Nylon 1-1/4" | | |



35 PC ADD-ON

Product #: **JTS-0035HVAC**



- › 35 Pieces.
- › 3/8" Drive Tools.
- › Designed for fastener sizes 3/8" - 7/8".
- › Tools only.
- › Contains: 28 Sockets and Accessories, 7 Wrenches.
- › Weight: 7.0 lbs.



Representative Image; Contents May Differ

| Contents | Description |
|----------|----------------------------------|
| J5270A | Adapter, Universal Joint 3/8" DR |
| J5259 | Extension 3/8" DR, 1-3/4" |
| J5260 | Extension, 3/8" DR 3" |
| J5260-06 | Extension, 3/8" DR 6" |
| J5249 | Ratchet, 3/8" DR |
| J5212 | Socket, 3/8" DR 3/8" 12 PT |
| J5214 | Socket, 3/8" DR 7/16" 12 PT |
| J5216 | Socket, 3/8" DR 1/2" 12 PT |
| J5218 | Socket, 3/8" DR 9/16" 12 PT |
| J5220 | Socket, 3/8" DR 5/8" 12 PT |
| J5222 | Socket, 3/8" DR 11/16" 12 PT |
| J5224 | Socket, 3/8" DR 3/4" 12 PT |
| J5226 | Socket, 3/8" DR 13/16" 12 PT |
| J5228 | Socket, 3/8" DR 7/8" 12 PT |
| J5012 | Socket, 3/8" DR 3/8" 12 PT Deep |
| J5014 | Socket, 3/8" DR 7/16" 12 PT Deep |
| J5016 | Socket, 3/8" DR 1/2" 12 PT Deep |
| J5018 | Socket, 3/8" DR 9/16" 12 PT Deep |

| Contents | Description |
|----------|--------------------------------------|
| J5020 | Socket, 3/8" DR 5/8" 12 PT Deep |
| J5022 | Socket, 3/8" DR 11/16" 12 PT Deep |
| J5024 | Socket, 3/8" DR 3/4" 12 PT Deep |
| J5026 | Socket, 3/8" DR 13/16" 12 PT Deep |
| J5028 | Socket, 3/8" DR 7/8" 12 PT Deep |
| J7210PF | Socket, Power 3/8" DR 5/16" Magnetic |
| J7212PF | Socket, Power 3/8" DR 3/8" Magnetic |
| J7214PF | Socket, Power 3/8" DR 7/16" Magnetic |
| J7216PF | Socket, Power 3/8" DR 1/2" Magnetic |
| J7218PF | Socket, Power 3/8" DR 9/16" Magnetic |
| J3812 | Wrench, Flare Nut Ratcheting 3/8" |
| J3814 | Wrench, Flare Nut Ratcheting 7/16" |
| J3816 | Wrench, Flare Nut Ratcheting 1/2" |
| J3818 | Wrench, Flare Nut Ratcheting 9/16" |
| J3820 | Wrench, Flare Nut Ratcheting 5/8" |
| J3822 | Wrench, Flare Nut Ratcheting 11/16" |
| J3824 | Wrench, Flare Nut Ratcheting 3/4" |



37 PC PLUMBER'S TOOL SET

Product #: JTS-0037PLUM



- › 37 Pieces.
- › Contains: 10 Wrenches, 5 Striking and Struck Tools, 6 Pliers, 4 Screwdrivers, 12 Miscellaneous Tools.
- › Enhanced version of Proto® 90-731 Plumber's Tool Set.
- › Weight: 41.0 lbs.



Representative Image; Contents May Differ

| Contents | Description |
|----------|---|
| 95-112W | Flashlight, Stanley® Tripod - 20 Lumens |
| 20-001 | Stanley® Hacksaw, High Tension Low Profile 12" |
| 15-809 | Stanley® Hacksaw, Metal Mini |
| 54-732 | Hammer, Ball Pein Jacketed Graphite 32 oz. |
| 51-505 | Hammer, Jacketed Graphite Nailing CC - 16 oz. |
| 10-788 | Knife, Utility QuickChange™ Retractable Blade |
| 43-609 | Level, FatMax® Xtreme™ Torpedo 9" |
| J294WRXL | Pliers, Locking Curved Jaw with Cutter 7-15/32" |
| J240G | Pliers, Needle-Nose Long Reach 11-9/16" |
| J276G | Pliers, Slip-Joint with Grip 6-9/16" |
| J260SG | Pliers, Tongue and Groove 10-3/16" with Grip |
| J265SG | Pliers, Tongue and Groove 16" with Grip |
| 20-556 | Saw, FatMax® Jab |
| 15-334 | Saw, SharpTooth™ 15" 9 PT |
| 62-559 | Screwdriver, Prodriver™ Phillips® 3" x #1 |
| 62-561 | Screwdriver, Prodriver™ Phillips® 4" x #2 |
| 62-553 | Screwdriver, Prodriver™ Std 1/4" x 4" |

| Contents | Description |
|----------|--|
| 62-555 | Screwdriver, Prodriver™ Std 5/16" x 6" |
| 16-298 | Chisel, 3 PC Stanley® Cold Chisel Set |
| 14-563 | Snip, Aviation MaxSteel® Straight |
| 33-725 | Tape Rule, FatMax® 1-1/4" x 25' |
| 518160M | Tote, Stanley® FatMax® 18" |
| J350 | Tubing Cutter |
| J351 | Tubing Flaring Tool |
| J708L | Wrench, Adjustable Klik-Stop® Chrome 8" |
| J712L | Wrench, Adjustable Klik-Stop® Chrome 12" |
| J801 | Wrench, Chain |
| J806HD | Wrench, Pipe Heavy-Duty 6" |
| J810HD | Wrench, Pipe Heavy-Duty 10" |
| J814HD | Wrench, Pipe Heavy-Duty 14" |
| J140-38 | Wrench, Pipe Internal 3/8" |
| J140-12 | Wrench, Pipe Internal 1/2" |
| J140-34 | Wrench, Pipe Internal 3/4" |
| J140-1 | Wrench, Pipe Internal 1" |



30 PC CONTRACTOR'S TOOL SET

Product #: **JTS-0030CONT**



- › 30 Pieces.
- › Contains: 7 Striking and Struck Tools, 7 Screwdrivers, 16 Miscellaneous Tools.
- › Enhanced version of Proto® 90-730 Contractor's Tool Set.
- › Weight: 27.0 lbs.



Representative Image; Contents May Differ

| Contents | Description |
|----------|---|
| 47-480L | Chalk Reel, Stanley® FatMax® Xtreme™ |
| 16-970 | Chisel, 3 PC Stanley® FatMax® Short Blade Set |
| J95120 | Construction Pouch, Professional 11 |
| 15-265 | Hacksaw, 3-7/8" |
| 51-941 | Hammer, Antivibe® Curved Claw 16 oz. |
| 10-099 | Knife, Stanley® Classic 99® Retractable Blade Utility |
| 43-548 | Level, Stanley® FatMax® Box Beam 48" |
| 43-609 | Level, FatMax® Xtreme™ Torpedo 9" |
| 58-230 | Nail Set, 3 PC Stanley® Square Head |
| 46-053 | Quick-Square® Premium with Adjustable Arm 6-3/4" |

| Contents | Description |
|----------|--|
| 17-205 | Saw, Compass Stanley® FatMax® 12" |
| 20-527 | Saw, Stanley® Fine Finish with Cushion Grip 20" |
| 69-122 | Scratch Awl, Stanley® |
| 60-060 | Screwdriver, 6 PC Stanley® Standard Fluted Set |
| 45-500 | Square, Carpenter Steel 16" x 24" |
| 46-123 | Square, Combination Prem Etched Blade 12" |
| 47-973 | Plumb Bob, Stanley® Brass 8 oz. |
| 33-525 | Tape Rule, Powerlock® 1" x 25' |
| 34-106 | Tape Rule, Stanley® Closed Case Long 3/8" x 100' |
| 518160M | Tote, Stanley® FatMax® 18" |
| 55-515 | Wonder Bar® 13-3/8" |



25 PC ELECTRICIAN'S TOOL SET

Product #: **JTS-0025ELEC**



- › 25 Pieces.
- › Contains: 1 Wrench, 1 Striking and Struck Tool, 6 Pliers, 6 Screwdrivers, 11 Miscellaneous Tools.
- › Enhanced version of Proto® 90-732 Electrician's Tool Set.
- › Weight: 20.0 lbs.



Representative Image; Contents May Differ

| Contents | Description |
|----------|--|
| J95230 | Belt, Wide Web 2" |
| 95-112W | Flashlight, Stanley® TriPod 20 LUMENS |
| 20-001 | Stanley® Hacksaw, High Tension Low Profile 12" |
| 15-809 | Stanley® Hacksaw, Metal Mini |
| 51-505 | Hammer, Jacketed Graphite Nailing CC 16 oz. |
| J18500 | Knife, Electrician's 3-3/4" |
| 10-788 | Knife, QuickChange™ Retractable Blade Utility |
| 43-609 | Level, FatMax® Xtreme™ Torpedo 9" |
| J209G | Pliers, Diagonal Cutting with Grip 7-5/16" |
| J268G | Pliers, Lineman's with Grip 8-5/8" |

| Contents | Description |
|----------|--|
| J240G | Pliers, Needle-Nose Long Reach 11-9/16" |
| J226G | Pliers, Needle-Nose with Cutter 6-5/8" |
| J260SG | Pliers, Tongue and Groove 10-3/16" with Grip |
| J299 | Pliers, Wire Stripper/Crimper 8-1/2" |
| 20-556 | Saw, FatMax® Jab |
| 66-565P | Screwdriver, 6 PC Stanley® Vinyl Grip |
| 33-725 | Tape Rule, FatMax® 1-1/4" x 25' |
| 511150M | Tool Bag, FatMax® Technician 12" |
| J708G | Wrench, Adjustable, 8" Grip |



FACOM® 39 PC 1000V VSE

Product #: **FC-2184C.VSE**

- ▶ For workshop or on-site electrical work.
- ▶ Supplied in case.
- ▶ Contains: 1 Wrench, 1 Striking and Struck Tool, 6 Pliers, 6 Screwdrivers, 11 miscellaneous tools.
- ▶ Weight: 32.3 lbs.



Representative Image; Contents May Differ

| Contents | Description |
|----------------|---|
| FA-412.14AVSE | Cutter, Cable 1000V VSE 9" |
| FA-414.45AVSE | Cutter, Cable RCH 1000V VSE 1-3/4" Diagonal |
| FM-83.3AVSE | Hex Key, 1000V VSE 3 mm |
| FM-83.4AVSE | Hex Key, 1000V VSE 4 mm |
| FM-83.6AVSE | Hex Key, 1000V VSE 6 mm |
| FT-1820.AVSE | Knife, 1000V VSE 2-3/8" |
| FA-195.20AVSE | Pliers, Bentnose 1000V VSE 7-7/8" |
| FA-187.18AVSE | Pliers, Combo 1000V VSE 7-1/4" |
| FA-192.16AVSE | Pliers, Diagonal 1000V VSE 6-1/2" |
| FA-391.16AVSE | Pliers, Diagonal Cutter 1000V VSE 6-1/2" |
| FA-190.16AVSE | Pliers, Endcutter 1000V VSE 6-1/2" |
| FA-188.16AVSE | Pliers, Flatnose 1000V VSE 6-1/2" |
| FA-180.VSE | Pliers, Multigrip 1000V VSE 10" |
| FA-189.17AVSE | Pliers, Round Nose 1000V VSE 6-1/2" |
| FM-DELA.401.00 | Rule, Folding 2 mm |
| FW-A3.5X100VE | Screwdriver, 1000V 3.5 mm Slot 7-7/8" |
| FW-A4X100VE | Screwdriver, 1000V 4 mm Slot 7-7/8" |
| FW-A5.5X150VE | Screwdriver, 1000V 5.5 mm Slot 10-1/8" |
| FW-A6.5X150VE | Screwdriver, 1000V 6.5 mm Slot 10-1/2" |
| FW-ABX150VE | Screwdriver, 1000V 8 mm Slot 10-1/2" |

| Contents | Description |
|---------------|---|
| FW-A10X200VE | Screwdriver, 1000V 10 mm Slot 12-3/4" |
| FW-AP1X100VE | Screwdriver, 1000V Round Bar #1 x 4" |
| FW-AP2X125VE | Screwdriver, 1000V Round Bar #2 x 5" |
| FW-AD1X100VE | Screwdriver, 1000V Pozidriv® Round Bar PZ1 x 4" |
| FW-AD3X150VE | Screwdriver, 1000V Pozidriv® Round Bar PZ3 x 6" |
| FT-701A | Tester, Multifunction |
| FT-BV.5A | Tool Briefcase 2184CVSE |
| FA-194.17AVSE | Wire Stripper, 1000V VSE 6.5 in |
| FM-46.8AVSE | Wrench, Combination 1000V VSE 8 mm |
| FM-46.10AVSE | Wrench, Combination 1000V VSE 10 mm |
| FM-46.12AVSE | Wrench, Combination 1000V VSE 12 mm |
| FM-46.13AVSE | Wrench, Combination 1000V VSE 13 mm |
| FM-46.14AVSE | Wrench, Combination 1000V VSE 14 mm |
| FM-46.17AVSE | Wrench, Combination 1000V VSE 17 mm |
| FM-46.19AVSE | Wrench, Combination 1000V VSE 19 mm |
| FM-46.21AVSE | Wrench, Combination 1000V VSE 21 mm |
| FM-94T.8AVSE | Nut Driver, T-Handle 1000V VSE 8 mm |
| FM-94T.10AVSE | Nut Driver, T-Handle 1000V VSE 10 mm |
| FM-94T.13AVSE | Nut Driver, T-Handle 1000V VSE 13 mm |



FACOM® 40 PC 1000V VSE

Product #: FC-2187C.VSE

- › Supplied in leather case.
- › Contains: 10 Sockets and Accessories, 9 Wrenches, 6 Pliers, 10 Screwdrivers, 6 Miscellaneous Tools.
- › Weight: 19.6 lbs.



Representative Image; Contents May Differ

| Contents | Description |
|---------------|---|
| FM-RT.4AVSE | Socket, Hex Bit 1/4" DR 1000V VSE 4 mm |
| FM-RT.5AVSE | Socket, Hex Bit 1/4" DR 1000V VSE 5 mm |
| FM-RT.6AVSE | Socket, Hex Bit 1/4" DR 1000V VSE 6 mm |
| FA-412.14AVSE | Cutter, Cable 1000V VSE 9" |
| FT-R.210AVSE | Extension, 1/4" DR 1000V VSE 4.5" |
| FT-BC.109VSE | Gloves, Leather Size 9" |
| FM-83.3AVSE | Hex Key, 1000V VSE 3 mm |
| FM-83.4AVSE | Hex Key, 1000V VSE 4 mm |
| FM-83.6AVSE | Hex Key, 1000V VSE 6 mm |
| FA-187.18AVSE | Pliers, Combination 1000V VSE 7-1/4" |
| FA-391.16AVSE | Pliers, Diagonal Cutters 1000V VSE 6-1/2" |
| FA-188.16AVSE | Pliers, Flat Nose 1000V VSE 6-1/2" |
| FA-189.17AVSE | Pliers, Round Nose 1000V VSE 6-1/2" |
| FT-R.151AVSE | Ratchet, 1/4" DR 1000V VSE 4-7/8" |
| FW-A3.5X100VE | Screwdriver, 1000V 3.5 mm Slotted 7-7/8" |
| FW-A4X100VE | Screwdriver, 1000V 4 mm Slotted 7-7/8" |
| FW-A5.5X150VE | Screwdriver, 1000V 5.5 mm Slotted 10-1/8" |
| FW-A6.5X150VE | Screwdriver, 1000V 6.5 mm Slotted 10-1/2" |
| FW-A8X150VE | Screwdriver, 1000V 8 mm Slotted 10-1/2" |
| FW-APOX75VE | Screwdriver, 1000V PHO |

| Contents | Description |
|----------------|--------------------------------------|
| FW-AP1X100VE | Screwdriver, 1000V Round Bar #1 x 4" |
| FW-AP2X125VE | Screwdriver, 1000V Round Bar #2 x 5" |
| FM-R.10AVSE | Socket, 1/4" DR 1000V VSE 10 mm |
| FM-R.12AVSE | Socket, 1/4" DR 1000V VSE 12 mm |
| FM-R.6AVSE | Socket, 1/4" DR 1000V VSE 6 mm |
| FM-R.7AVSE | Socket, 1/4" DR 1000V VSE 7 mm |
| FM-R.8AVSE | Socket, 1/4" DR 1000V VSE 8 mm |
| FT-AV.HT1B | Scwdriver, Volt Test 90-480V |
| FT-701A | Tester, Multifunction |
| FT-BV.7A | Tool, Briefcase |
| FA-194.17AVSE | Wire Stripper, 1000V VSE 6-1/2" |
| FA-113.10TAVSE | Wrench, Adjustable 1000V VSE 10" |
| FM-46.8AVSE | Wrench, Combination 1000V VSE 8 mm |
| FM-46.10AVSE | Wrench, Combination 1000V VSE 10 mm |
| FM-46.11AVSE | Wrench, Combination 1000V VSE 11 mm |
| FM-46.12AVSE | Wrench, Combination 1000V VSE 12 mm |
| FM-46.13AVSE | Wrench, Combination 1000V VSE 13 mm |
| FM-46.14AVSE | Wrench, Combination 1000V VSE 14 mm |
| FM-46.17AVSE | Wrench, Combination 1000V VSE 17 mm |
| FM-46.19AVSE | Wrench, Combination 1000V VSE 19 mm |



FACOM® 28 PC 1000V VSE

Product #: **FC-2185C.VSE**

- › Supplied in a case with modular storage.
- › Basic general purpose tools supplied in a plastic box.
- › Spare capacity for additional tools.
- › Contains: 10 Sockets and Accessories, 1 Wrench, 6 Pliers,

- 7 Screwdrivers, 4 Miscellaneous Tools
- › Weight: 16.51 lbs.



Representative Image; Contents May Differ

| Contents | Description |
|----------------|---|
| FM-RT.4AVSE | Socket, Hex Bit 1/4" DR 1000V VSE 4 mm |
| FM-RT.5AVSE | Socket, Hex Bit 1/4" DR 1000V VSE 5 mm |
| FM-RT.6AVSE | Socket, Hex Bit 1/4" DR 1000V VSE 6 mm |
| FA-412.14AVSE | Cutter, Cable 1000V VSE 9" |
| FT-R.210AVSE | Extension, 1/4" DR 1000V VSE 4-1/2" |
| FT-BC.109VSE | Gloves, Leather Size 9" |
| FT-1820.AVSE | Knife, 1000V VSE 2-3/8" |
| FA-187.18AVSE | Pliers, Combination 1000V VSE 7-1/4" |
| FA-192.16AVSE | Pliers, Diagonal 1000V VSE 6-1/2" |
| FA-391.16AVSE | Pliers, Diagonal Cutters 1000V VSE 6-1/2" |
| FA-188.16AVSE | Pliers, Flat Nose 1000V VSE 6-1/2" |
| FT-R.151AVSE | Ratchet, 1/4" DR 1000V VSE 4-7/8" |
| FM-DELA.401.00 | Rule, Folding 2 mm |
| FW-A4X100VE | Screwdriver, 1000V 4 mm Slotted 7-7/8" |
| FW-A5.5X150VE | Screwdriver, 1000V 5.5 mm Slotted 10-1/8" |

| Contents | Description |
|----------------|---|
| FW-A6.5X150VE | Screwdriver, 1000V 6.5 mm Slotted 10-1/2" |
| FW-A8X150VE | Screwdriver, 1000V 8 mm Slotted 10-1/2" |
| FW-AP1X100VE | Screwdriver, 1000V PH1 |
| FW-AP2X125VE | Screwdriver, 1000V PH2 |
| FT-AV.HT1B | Screwdriver, Voltage Test 90-480V |
| FM-R.6AVSE | Socket, 1/4 DR 1000V VSE 6 mm |
| FM-R.7AVSE | Socket, 1/4 DR 1000V VSE 7 mm |
| FM-R.8AVSE | Socket, 1/4 DR 1000V VSE 8 mm |
| FM-R.10AVSE | Socket, 1/4 DR 1000V VSE 10 mm |
| FM-R.12AVSE | Socket, 1/4 DR 1000V VSE 12 mm |
| FA-194.17AVSE | Wire Stripper, 1000V VSE 6-1/2" |
| FA-113.10TAVSE | Wrench, Adjustable 1000V VSE 10" |
| FT-BP.P26 | Tool Box |



FACOM® 9 PC 1000V VSE

Product #: FC-2180B.VSE

- › Basic set for servicing workshop electrical gear.
- › Supplied in leather case.
- › Contains: 3 Screwdrivers, 4 Pliers, 2 Miscellaneous Tools.
- › Weight: 4.12 lbs..



Representative Image; Contents May Differ

| Contents | Description |
|---------------|---|
| FT-1820.AVSE | Knife, 1000V VSE 2-3/8" |
| FA-187.18AVSE | Pliers, Combination 1000V VSE 7-1/4" |
| FA-391.16AVSE | Pliers, Diagonal Cutters 1000V VSE 6-1/2" |
| FA-189.17AVSE | Pliers, Round Nose 1000V VSE 6-1/2" |
| FW-A4X100VE | Screwdriver, 1000V 4 mm Slot 7-7/8" |

| Contents | Description |
|---------------|--|
| FW-A5.5X150VE | Screwdriver, 1000V 5.5 mm Slot 10-1/8" |
| FW-AP1X100VE | Screwdriver, 1000V Round Bar #1 x 4" |
| FT-BV.100 | Tool Bag, Leather 2180BVSE |
| FA-194.17AVSE | Wire Stripper, 1000V VSE 6.5" |



SUB SETS

Product #: **J99485**



► Weight: 43.0 lbs.

| Contents | Description |
|-----------|---|
| J5470A | Adapter, Universal Joint 1/2" DR |
| J2126 | Bar, 12" Long 1/2" Tip |
| J2120 | Bar, Pry Aligning 18" |
| J9521 | Extractor, Screw 1/8" |
| J9522 | Extractor, Screw 3/16" |
| J9525 | Extractor, Screw 3/8" |
| J9523 | Extractor, Screw 15/64" |
| J9524 | Extractor, Screw 5/16" |
| J5460 | Extension, 1/2" DR 2-1/2" |
| J5461 | Extension, 1/2" DR 5" |
| J5463 | Extension, 1/2" DR 10" |
| J1316PD | Hammer, Ball Pein 16 oz. |
| 57-532 | Hammer, Compo-Cast® 21 oz. |
| J5480G | Handle, Speed 1/2 DR |
| J5467 | Handle, Hinge 1/2" DR 15-3/4" |
| J209G | Pliers, Diagonal Cutting with Grip 7-5/16" |
| J268G | Pliers, Lineman's with Grip 8-5/8" |
| J292NC | Pliers, Locking Curved 10" |
| J226G | Pliers, Needle-Nose with Cutter 6-5/8" |
| J260SG | Pliers, Tongue and Groove 10-3/16" with Grip |
| J298 | Pliers, Wire Strippers 8-1/4" |
| J5449 | Ratchet, 1/2" DR |
| J2336 | Scrapers, Gasket and Carbon |
| J380 | Pliers, 6 PC Retaining Ring Set with Replacement Tips |
| J49901/8 | Socket, Hex Bit 3/8" DR 1/8" |
| J49901/4 | Socket, Hex Bit 3/8" DR 1/4" |
| J49903/8 | Socket, Hex Bit 3/8" DR 3/8" |
| J54411/2 | Socket, Hex Bit 1/2" DR 1/2" |
| J54415/8 | Socket, Hex Bit 1/2" DR 5/8" |
| J54419/16 | Socket, Hex Bit 1/2" DR 9/16" |
| J5412 | Socket, 1/2" DR 3/8" 12 PT |
| J5414 | Socket, 1/2" DR 7/16" 12 PT |
| J5416 | Socket, 1/2" DR 1/2" 12 PT |

| Contents | Description |
|-----------|--------------------------------------|
| J5418 | Socket, 1/2" DR 9/16" 12 PT |
| J5420 | Socket, 1/2" DR 5/8" 12 PT |
| J5422 | Socket, 1/2" DR 11/16" 12 PT |
| J5424 | Socket, 1/2" DR 3/4" 12 PT |
| J5426 | Socket, 1/2" DR 13/16" 12 PT |
| J5428 | Socket, 1/2" DR 7/8" 12 PT |
| J5430 | Socket, 1/2" DR 15/16" 12 PT |
| J5432 | Socket, 1/2" DR 1" 12 PT |
| J5434 | Socket, 1/2" DR 1-1/16" 12 PT |
| J5436 | Socket, 1/2" DR 1-1/8" 12 PT |
| J5440 | Socket, 1/2" DR 1-1/4" 12 PT |
| J5316 | Socket, 1/2" DR 1/2" 12 PT Deep |
| J5318 | Socket, 1/2" DR 9/16" 12 PT Deep |
| J5320 | Socket, 1/2" DR 5/8" 12 PT Deep |
| J5322 | Socket, 1/2" DR 11/16" 12 PT Deep |
| J5324 | Socket, 1/2" DR 3/4" 12 PT Deep |
| J5326 | Socket, 1/2" DR 13/16" 12 PT Deep |
| J5328 | Socket, 1/2" DR 7/8" 12 PT Deep |
| J5330 | Socket, 1/2" DR 15/16" 12 PT Deep |
| J5332 | Socket, 1/2" DR 1" 12 PT Deep |
| J5334 | Socket, 1/2" DR 1-1/16" 12 PT Deep |
| J5336 | Socket, 1/2" DR 1-1/8" 12 PT Deep |
| J5340 | Socket, 1/2" DR 1-1/4" 12 PT Deep |
| J49905/32 | Socket, Hex Bit 3/8" DR 5/32" |
| J49903/16 | Socket, Hex Bit 3/8" DR 3/16" |
| J49907/32 | Socket, Hex Bit 3/8" DR 7/32" |
| J49905/16 | Socket, Hex Bit 3/8" DR 5/16" |
| J710 | Wrench, Adjustable 10" |
| J712 | Wrench, Adjustable 12" |
| J1120 | Wrench, Box 5/16" x 3/8" 12 PT Short |
| J1122 | Wrench, Box 3/8" x 7/16" 12 PT Short |
| J1126 | Wrench, Box 1/2" x 9/16" 12 PT Short |
| J1131 | Wrench, Box 5/8" x 3/4" 12 PT Short |



SUB SETS

Product #: J99665



Weight: 64.0 lbs.

| Contents | Description |
|--------------|--|
| J5470A | Adapter, Universal Joint 1/2" DR |
| J86A3/16 | Chisel, Cold 1/4" |
| J86A1/4 | Chisel, Cold 5/16" |
| J86A5/16 | Chisel, Cold 3/8" |
| J86A7/16 | Chisel, Cold 1/2" |
| J86A1/2 | Chisel, Cold 5/8" |
| J86A5/8 | Chisel, Cold 3/4" |
| J86A3/4X8 | Chisel, Cold 7/8" |
| J86A7/8X8 | Chisel, Cold 1" |
| J86A1X8 | Chisel, Cold 1-3/16" |
| J5460 | Extension, 1/2" DR 2-1/2" |
| J5461 | Extension, 1/2" DR 5" |
| J5463 | Extension, 1/2" DR 10" |
| 15-265 | Hacksaw, 3-7/8" |
| J1316PD | Hammer, Ball Pein 16 oz. |
| J5468 | Handle, Hinge 1/2" DR |
| J5485 | Handle, Sliding T 1/2" DR |
| J5480G | Handle, Speed 1/2" DR |
| J2108 | Holder, Punch and Chisel |
| 10-099 | Knife, Stanley® Classic 99® Retractable Blade Utility |
| J1368 | Mallet, Rubber |
| J209G | Pliers, Diagonal Cutting with Grip 7-5/16" |
| J272G | Pliers, End Cutting High Leverage 8-1/4" |
| J268G | Pliers, Lineman's with Grip 8-5/8" |
| J291NC | Pliers, Locking Straight 7" |
| J225G | Pliers, Needle-Nose Bent Nose 6-5/16" |
| J278G | Pliers, Slip-Joint with Grip 8-1/16" |
| J413/8 | Punch, Center 3/8" |
| J411/2 | Punch, Center 1/2" |
| J965/16 | Punch, Drift 1/8" |
| J963/8 | Punch, Drift 3/16" |
| J961/2 | Punch, Drift 1/4" |
| J471/4X3/32 | Punch, Pin 3/32" |
| J475/16X1/8 | Punch, Pin 1/8" |
| J475/16X5/32 | Punch, Pin 5/32" |
| J473/8X3/16 | Punch, Pin 3/16" |
| J477/16X7/32 | Punch, Pin 7/32" |
| J471/2X1/4 | Punch, Pin 1/4" |
| J445/16 | Punch, Prick 5/16" |
| J501/4 | Punch, Starting 3/32" |
| J505/16 | Punch, Starting 1/8" |
| J503/8 | Punch, Starting 3/16" |
| J507/16 | Punch, Starting 7/32" |
| J501/2 | Punch, Starting 1/4" |
| J5449 | Ratchet, 1/2" DR |
| J5450 | Ratchet, 1/2" DR (Long Handle) |
| J5447 | Ratchet, Adapter 1/2" DR 2-1/16" |
| J303S | Snips, Aviation Straight |
| J5412S | Socket, 1/2" DR 3/8" 8 PT |
| J5414S | Socket, 1/2" DR 7/16" 8 PT |
| J5416S | Socket, 1/2" DR 1/2" 8 PT |
| J5418S | Socket, 1/2" DR 9/16" 8 PT |
| J5420S | Socket, 1/2" DR 5/8" 8 PT |

| Contents | Description |
|-----------|---------------------------------------|
| J5422S | Socket, 1/2" DR 11/16" 8 PT |
| J5424S | Socket, 1/2" DR 3/4" 8 PT |
| J5426S | Socket, 1/2" DR 13/16" 8 PT |
| J5428S | Socket, 1/2" DR 7/8" 8 PT |
| J5432S | Socket, 1/2" DR 1" 8 PT |
| J5412 | Socket, 1/2" DR 3/8" 12 PT |
| J5414 | Socket, 1/2" DR 7/16" 12 PT |
| J5416 | Socket, 1/2" DR 1/2" 12 PT |
| J5418 | Socket, 1/2" DR 9/16" 12 PT |
| J5419 | Socket, 1/2" DR 19/32" 12 PT |
| J5420 | Socket, 1/2" DR 5/8" 12 PT |
| J5422 | Socket, 1/2" DR 11/16" 12 PT |
| J5424 | Socket, 1/2" DR 3/4" 12 PT |
| J5425 | Socket, 1/2" DR 25/32" 12 PT |
| J5426 | Socket, 1/2" DR 13/16" 12 PT |
| J5428 | Socket, 1/2" DR 7/8" 12 PT |
| J5429 | Socket, 1/2" DR 29/32" 12 PT |
| J5430 | Socket, 1/2" DR 15/16" 12 PT |
| J5432 | Socket, 1/2" DR 1" 12 PT |
| J5434 | Socket, 1/2" DR 1-1/16" 12 PT |
| J5436 | Socket, 1/2" DR 1-1/8" 12 PT |
| J5438 | Socket, 1/2" DR 1-3/16" 12 PT |
| J5440 | Socket, 1/2" DR 1-1/4" 12 PT |
| J5442 | Socket, 1/2" DR 1-5/16" 12 PT |
| J5444 | Socket, 1/2" DR 1-3/8" 12 PT |
| J5446 | Socket, 1/2" DR 1-7/16" 12 PT |
| J5448 | Socket, 1/2" DR 1-1/2" 12 PT |
| J5332 | Socket, 1/2" DR 1" 12 PT Deep |
| J5316 | Socket, 1/2" DR 1/2" 12 PT Deep |
| J5320 | Socket, 1/2" DR 5/8" 12 PT Deep |
| J5324 | Socket, 1/2" DR 3/4" 12 PT Deep |
| J5328 | Socket, 1/2" DR 7/8" 12 PT Deep |
| J5318 | Socket, 1/2" DR 9/16" 12 PT Deep |
| J5322 | Socket, 1/2" DR 11/16" 12 PT Deep |
| J5326 | Socket, 1/2" DR 13/16" 12 PT Deep |
| J5330 | Socket, 1/2" DR 15/16" 12 PT Deep |
| J5334 | Socket, 1/2" DR 1-1/16" 12 PT Deep |
| J5336 | Socket, 1/2" DR 1-1/8" 12 PT Deep |
| J5340 | Socket, 1/2" DR 1-1/4" 12 PT Deep |
| J5444A | Socket, 1/2" DR Drag Link 3/4" |
| J5475A | Socket, Universal 1/2" DR 1/2" 12 PT |
| J5476A | Socket, Universal 1/2" DR 9/16" 12 PT |
| J5477A | Socket, Universal 1/2" DR 5/8" 12 PT |
| J54411/4 | Socket, Hex Bit 1/2" DR 1/4" |
| J54415/16 | Socket, Hex Bit 1/2" DR 5/16" |
| J54413/8 | Socket, Hex Bit 1/2" DR 3/8" |
| J54417/16 | Socket, Hex Bit 1/2" DR 7/16" |
| J54411/2 | Socket, Hex Bit 1/2" DR 1/2" |
| J54419/16 | Socket, Hex Bit 1/2" DR 9/16" |
| J54415/8 | Socket, Hex Bit 1/2" DR 5/8" |
| J710 | Wrench, Adjustable 10" |
| J810HD | Wrench, Pipe Heavy-Duty 10" |
| J6014C | Wrench, Torque 1/2" DR 50-250 ft-lbs |



SUB SETS

Product #: J99825



► Weight: 42.7 lbs.

| Contents | Description |
|--------------|--|
| J86A3/16 | Chisel, Cold 1/4" |
| J86A1/4 | Chisel, Cold 5/16" |
| J86A5/16 | Chisel, Cold 3/8" |
| J86A7/16 | Chisel, Cold 1/2" |
| J86A1/2 | Chisel, Cold 5/8" |
| J86A5/8 | Chisel, Cold 3/4" |
| J86A3/4X8 | Chisel, Cold 7/8" |
| J86A7/8X8 | Chisel, Cold 1" |
| J86A1X8 | Chisel, Cold 1-3/16" |
| J5268 | Extension, Flex 3/8" DR 8" |
| J1316PD | Hammer, Ball Pein 16 oz. |
| J4980 | Hex Key, 13 PC Standard Set |
| J2108 | Holder, Punch and Chisel |
| J95218 | Knife, Folding Blade |
| J18545B | Knife, Lockback 5" |
| J9206 | Nut Driver, 3/16" |
| J9207 | Nut Driver, 7/32" |
| J9208 | Nut Driver, 1/4" |
| J9209 | Nut Driver, 9/32" |
| J9210 | Nut Driver, 5/16" |
| J9211 | Nut Driver, 11/32" |
| J9212 | Nut Driver, 3/8" |
| J9214 | Nut Driver 7/16" |
| J9216 | Nut Driver, 1/2" |
| J9218 | Nut Driver, 9/16" |
| J9220 | Nut Driver, 5/8" |
| J206G | Pliers, Diagonal Cutting with Grip 6-1/16" |
| J209G | Pliers, Diagonal Cutting with Grip 7-5/16" |
| J227G | Pliers, Duckbill with Grip 7-25/32" |
| J272G | Pliers, End Cutting High Leverage 8-1/4" |
| J268G | Pliers, Lineman's with Grip 8-5/8" |
| J292NC | Pliers, Locking Curved 10" |
| J226G | Pliers, Needle-Nose with Cutter 6-5/8" |
| J278G | Pliers, Slip-Joint with Grip 8-1/16" |
| J298 | Pliers, Wire Strippers 8-1/4" |
| J413/8 | Punch, Center 3/8" |
| J411/2 | Punch, Center 1/2" |
| J965/16 | Punch, Drift 1/8" |
| J963/8 | Punch, Drift 3/16" |
| J961/2 | Punch, Drift 1/4" |
| J471/4X3/32 | Punch, Pin 3/32" |
| J475/16X1/8 | Punch, Pin 1/8" |
| J475/16X5/32 | Punch, Pin 5/32" |
| J473/8X3/16 | Punch, Pin 3/16" |
| J477/16X7/32 | Punch, Pin 7/32" |
| J471/2X1/4 | Punch, Pin 1/4" |
| J445/16 | Punch, Prick 5/16" |
| J501/4 | Punch, Starting 3/32" |

| Contents | Description |
|----------|--|
| J505/16 | Punch, Starting 1/8" |
| J503/8 | Punch, Starting 3/16" |
| J507/16 | Punch, Starting 7/32" |
| J501/2 | Punch, Starting 1/4" |
| J5257F | Ratchet, 3/8" DR Flex-Head 2-1/16" |
| J88203 | Screwdriver, Slotted Cabinet, Round 1/8" x 3" |
| J88204 | Screwdriver, Slotted Cabinet, Round 1/8" x 4" |
| J88208 | Screwdriver, Slotted Cabinet, Round 1/8" x 8" |
| J88214 | Screwdriver, Slotted Cabinet, Round 3/16" x 4" |
| J88218 | Screwdriver, Slotted Cabinet, Round 3/16" x 8" |
| J88393 | Screwdriver, Phillips® #0 |
| J88313 | Screwdriver, Phillips® #1 |
| J88318 | Screwdriver, Phillips® #1 |
| J88322 | Screwdriver, Phillips® #2 |
| J88324 | Screwdriver, Phillips® #2 |
| J88328 | Screwdriver, Phillips® #2 |
| J88336 | Screwdriver, Phillips® #3 |
| J88348 | Screwdriver, Phillips® #4 |
| J88102 | Screwdriver, Slotted Keystone, Square 1/4" x 2" |
| J88104 | Screwdriver, Slotted Keystone, Square 1/4" x 4" |
| J88106 | Screwdriver, Slotted Keystone, Square 1/4" x 6" |
| J88108 | Screwdriver, Slotted Keystone, Square 1/4" x 8" |
| J88112 | Screwdriver, Slotted Keystone, Square 1/4" x 12" |
| J88002 | Screwdriver, Slotted Keystone, Round 1/4" x 1-1/2" |
| J708 | Wrench, Adjustable 8" |
| J710 | Wrench, Adjustable 10" |
| J1170 | Wrench, Box 5/16" x 3/8" 12 PT |
| J1171 | Wrench, Box 7/16" x 1/2" 12 PT |
| J1172 | Wrench, Box 9/16" x 5/8" 12 PT |
| J1173 | Wrench, Box 11/16" x 3/4" 12 PT |
| J1174 | Wrench, Box 13/16" x 7/8" 12 PT |
| J1175 | Wrench, Box 15/16" x 1" 12 PT |
| J1176 | Wrench, Box 1-1/16" x 1-1/8" 12 PT |
| J1122 | Wrench, Box 3/8" x 7/16" 12 PT Short |
| J1120 | Wrench, Box 5/16" x 3/8" 12 PT Short |
| J1126 | Wrench, Box 1/2" x 9/16" 12 PT Short |
| J1131 | Wrench, Box 5/8" x 3/4" 12 PT Short |
| J808HD | Wrench, Pipe Heavy-Duty 8" |
| J3018 | Wrench, Open End 1/4" x 5/16" |
| J3020 | Wrench, Open End 3/8" x 5/16" |
| J3025 | Wrench, Open End 7/16" x 1/2" |
| J3026 | Wrench, Open End 1/2" x 9/16" |
| J3030 | Wrench, Open End 9/16" x 5/8" |
| J3031 | Wrench, Open End 5/8" x 3/4" |
| J3035 | Wrench, Open End 11/16" x 3/4" |
| J3040 | Wrench, Open End 13/16" x 7/8" |
| J3045 | Wrench, Open End 15/16" x 1" |
| J3050 | Wrench, Open End 1-1/16" x 1-1/8" |



SUB SETS

Product #: J99835



Weight: 91.0 lbs.

| Contents | Description |
|-----------|---|
| J5470A | Adapter, Universal Joint 1/2" DR |
| J2126 | Bar, 12" Long 1/2" Tip |
| J2130 | Bar, 16" Long 5/8" Tip |
| J2120 | Bar, Pry Aligning 18" |
| J2124 | Bar, Pry Aligning 24" |
| J404 | C-Clamps, Capacity 0" and 4", 2 Each |
| J9521 | Extractor, Screw 1/8" |
| J9522 | Extractor, Screw 3/16" |
| J9523 | Extractor, Screw 15/64" |
| J9524 | Extractor, Screw 5/16" |
| J9525 | Extractor, Screw 3/8" |
| J9525B | Extractor, Screw 15/32" |
| J9526 | Extractor, Screw 9/16" |
| J9527 | Extractor, Screw 21/32" |
| J9528 | Extractor, Screw 13/16" |
| J9529 | Extractor, Screw 1-1/16" |
| J5460 | Extension, 1/2" DR 2-1/2" |
| J5461 | Extension, 1/2" DR 5" |
| J5463 | Extension, 1/2" DR 10" |
| J5260-06W | Extension, Wobble 3/8" DR 6" |
| 15-265 | Hacksaw, 3-7/8" |
| J1332PD | Hammer, Ball Pein 32 oz. |
| J5468 | Handle, Hinge 1/2" DR |
| J5485 | Handle, Sliding T 1/2" DR |
| J4780G | Handle, Speed 1/4 DR |
| J5480G | Handle, Speed 1/2 DR |
| 10-099 | Knife, Stanley® Classic 99® Retractable Blade Utility |
| J1368 | Mallet, Rubber |
| J2373 | Mirror, Rectangular Telescoping 2-1/8" |
| J286LNXL | Pliers, Locking Mini Long Nose 6-29/32" |
| J225G | Pliers, Needle-Nose Bent Nose 6-5/16" |
| J222G | Pliers, Needle-Nose Long Thin 6-1/16" |
| J360B | Pliers, 12 PC Set Convertible Retaining Ring |
| J2306 | Puller, Cotter Pin Tool |
| J4056-4 | Puller, Jaw Reversible 4 R |
| J4250N | Puller, Nut Adjustable Reversible |
| J4056PN | Puller, Pin Pivot |
| J4205S | Puller, Screw Forcing Acme |
| J4022T | Puller, Tip Detachable Standard |
| J4255B | Puller, Yoke 3 Way Jaw ACM |
| J4749 | Ratchet, 1/4" DR |
| J5449 | Ratchet, 1/2" DR |
| J5450 | Ratchet, 1/2" DR (Long Handle) |
| J5447 | Ratchet, Adapter 1/2" DR 2-1/16" |
| J5457F | Ratchet, 1/2" DR Flex-Head 17-3/32" |
| J2375 | Retrieval Tool, Pocket Magnetic |
| 28-540 | Scraper, Flexible 1-1/4" Wood Handle |
| 28-240 | Scraper, Flexible Nylon 1-1/4" |
| J2336 | Scrapers, Gasket and Carbon |
| J9884 | Screw Starter, Phillips® Tip |
| J9853 | Screw Starter, Standard Tip |
| J303S | Ships, Aviation Straight |
| J308 | Ships, Miniature |
| J5412S | Socket, 1/2" DR 3/8" 8 PT |

| Contents | Description |
|-----------|-------------------------------------|
| J5414S | Socket, 1/2" DR 7/16" 8 PT |
| J5416S | Socket, 1/2" DR 1/2" 8 PT |
| J5418S | Socket, 1/2" DR 9/16" 8 PT |
| J5420S | Socket, 1/2" DR 5/8" 8 PT |
| J5422S | Socket, 1/2" DR 11/16" 8 PT |
| J5424S | Socket, 1/2" DR 3/4" 8 PT |
| J5426S | Socket, 1/2" DR 13/16" 8 PT |
| J5428S | Socket, 1/2" DR 7/8" 8 PT |
| J5432S | Socket, 1/2" DR 1" 8 PT |
| J5419 | Socket, 1/2" DR 19/32" 12 PT |
| J5412 | Socket, 1/2" DR 3/8" 12 PT |
| J5414 | Socket, 1/2" DR 7/16" 12 PT |
| J5416 | Socket, 1/2" DR 1/2" 12 PT |
| J5418 | Socket, 1/2" DR 9/16" 12 PT |
| J5420 | Socket, 1/2" DR 5/8" 12 PT |
| J5422 | Socket, 1/2" DR 11/16" 12 PT |
| J5424 | Socket, 1/2" DR 3/4" 12 PT |
| J5425 | Socket, 1/2" DR 25/32" 12 PT |
| J5426 | Socket, 1/2" DR 13/16" 12 PT |
| J5428 | Socket, 1/2" DR 7/8" 12 PT |
| J5429 | Socket, 1/2" DR 29/32" 12 PT |
| J5430 | Socket, 1/2" DR 15/16" 12 PT |
| J5432 | Socket, 1/2" DR 1" 12 PT |
| J5434 | Socket, 1/2" DR 1-1/16" 12 PT |
| J5436 | Socket, 1/2" DR 1-1/8" 12 PT |
| J5438 | Socket, 1/2" DR 1-3/16" 12 PT |
| J5440 | Socket, 1/2" DR 1-1/4" 12 PT |
| J5442 | Socket, 1/2" DR 1-5/16" 12 PT |
| J5444 | Socket, 1/2" DR 1-3/8" 12 PT |
| J5446 | Socket, 1/2" DR 1-7/16" 12 PT |
| J5448 | Socket, 1/2" DR 1-1/2" 12 PT |
| J5316 | Socket, 1/2" DR 1/2" 12 PT Deep |
| J5318 | Socket, 1/2" DR 9/16" 12 PT Deep |
| J5320 | Socket, 1/2" DR 5/8" 12 PT Deep |
| J5322 | Socket, 1/2" DR 11/16" 12 PT Deep |
| J5324 | Socket, 1/2" DR 3/4" 12 PT Deep |
| J5326 | Socket, 1/2" DR 13/16" 12 PT Deep |
| J5328 | Socket, 1/2" DR 7/8" 12 PT Deep |
| J5330 | Socket, 1/2" DR 15/16" 12 PT Deep |
| J5332 | Socket, 1/2" DR 1" 12 PT Deep |
| J5334 | Socket, 1/2" DR 1-1/16" 12 PT Deep |
| J5336 | Socket, 1/2" DR 1-1/8" 12 PT Deep |
| J5340 | Socket, 1/2" DR 1-1/4" 12 PT Deep |
| J5444A | Socket, 1/2" DR Drag Link |
| J5446A | Socket, 1/2" DR Drag Link |
| J54411/4 | Socket, Hex Bit 1/2 DR 1/4" |
| J54415/16 | Socket, Hex Bit 1/2 DR 5/16" |
| J54413/8 | Socket, Hex Bit 1/2 DR 3/8" |
| J54417/16 | Socket, Hex Bit 1/2 DR 7/16" |
| J54411/2 | Socket, Hex Bit 1/2 DR 1/2" |
| J54419/16 | Socket, Hex Bit 1/2 DR 9/16" |
| J54415/8 | Socket, Hex Bit 1/2 DR 5/8" |
| J4771TA | Socket, Universal 1/4 DR 1/4 12 PT |
| J4772TA | Socket, Universal 1/4 DR 5/16 12 PT |

(CONTINUED ON NEXT PAGE)



SUB SETS (CONTINUED)

Product #: J99835



| Contents | Description |
|----------|--|
| J4773TA | Socket, Universal 1/4" DR 3/8" 12 PT |
| J4774TA | Socket, Universal 1/4" DR 7/16" 12 PT |
| J5475A | Socket, Universal 1/2" DR 1/2" 12 PT |
| J5476A | Socket, Universal 1/2" DR 9/16" 12 PT |
| J5477A | Socket, Universal 1/2" DR 5/8" 12 PT |
| J712 | Wrench, Adjustable 12" |
| J3314 | Wrench, Angle 7/32" |
| J3315 | Wrench, Angle 15/64" |
| J3316 | Wrench, Angle 1/4" |
| J3318 | Wrench, Angle 9/32" |
| J3320 | Wrench, Angle 5/16" |
| J3322 | Wrench, Angle 1 1/32" |
| J3324 | Wrench, Angle 3/8" |
| J3328 | Wrench, Angle 7/16" |
| J3332 | Wrench, Angle 1/2" |
| J4912CF | Wrench, Crowfoot 3/8" DR 3/8" Open End |
| J4914CF | Wrench, Crowfoot 3/8" DR 7/16" Open End |
| J4916CF | Wrench, Crowfoot 3/8" DR 1/2" Open End |
| J4918CF | Wrench, Crowfoot 3/8" DR 9/16" Open End |
| J4920CF | Wrench, Crowfoot 3/8" DR 5/8" Open End |
| J4922CF | Wrench, Crowfoot 3/8" DR 11/16" Open End |
| J4924CF | Wrench, Crowfoot 3/8" DR 3/4" Open End |
| J4926CF | Wrench, Crowfoot 3/8" DR 13/16" Open End |
| J4928CF | Wrench, Crowfoot 3/8" DR 7/8" Open End |
| J1204EF | Wrench, Combination 1/8" 6 PT Short |
| J1205EF | Wrench, Combination 5/32" 6 PT Short |
| J1206EF | Wrench, Combination 3/16" 6 PT Short |
| J1208EF | Wrench, Combination 1/4" 6 PT Short |
| J1209EF | Wrench, Combination 9/32" 6 PT Short |
| J1210EF | Wrench, Combination 5/16" 6 PT Short |
| J1211EF | Wrench, Combination 11/32" 6 PT Short |
| J1212EF | Wrench, Combination 3/8" 6 PT Short |

| Contents | Description |
|----------|--|
| J3751 | Wrench, Flare Nut Combination 3/8" 6 PT |
| J3752 | Wrench, Flare Nut Combination 7/16" 6 PT |
| J3753 | Wrench, Flare Nut Combination 1/2" 6 PT |
| J3754 | Wrench, Flare Nut Combination 9/16" 6 PT |
| J3755 | Wrench, Flare Nut Combination 5/8" 6 PT |
| J3756 | Wrench, Flare Nut Combination 11/16" 6 PT |
| J3757 | Wrench, Flare Nut Combination 3/4" 6 PT |
| J3812 | Wrench, Flare Nut Ratcheting 3/8" |
| J3814 | Wrench, Flare Nut Ratcheting 7/16" |
| J3816 | Wrench, Flare Nut Ratcheting 1/2" |
| J3818 | Wrench, Flare Nut Ratcheting 9/16" |
| J3820 | Wrench, Flare Nut Ratcheting 5/8" |
| J3822 | Wrench, Flare Nut Ratcheting 11/16" |
| J3824 | Wrench, Flare Nut Ratcheting 3/4" |
| J1725 | Wrench, Obstruction 7/16" x 1/2" |
| J1730 | Wrench, Obstruction 9/16" x 5/8" |
| J1731 | Wrench, Obstruction 5/8" x 3/4" |
| J810HD | Wrench, Pipe Heavy-Duty 10" |
| J814HD | Wrench, Pipe Heavy-Duty 14" |
| J1191T-A | Wrench, Ratcheting Box 1/4" x 5/16" 12 PT |
| J1192T-A | Wrench, Ratcheting Box 3/8" x 7/16" 12 PT |
| J1193T-A | Wrench, Ratcheting Box 1/2" x 9/16" 12 PT |
| J1194-A | Wrench, Ratcheting Box 5/8" x 11/16" 12 PT |
| J1195-A | Wrench, Ratcheting Box 3/4" x 7/8" 12 PT |
| J1270-12 | Wrench, Swivel Combination 3/8" 12 PT |
| J1270-14 | Wrench, Swivel Combination 7/16" 12 PT |
| J1270-16 | Wrench, Swivel Combination 1/2" 12 PT |
| J1270-18 | Wrench, Swivel Combination 9/16" 12 PT |
| J1270-20 | Wrench, Swivel Combination 5/8" 12 PT |
| J1270-22 | Wrench, Swivel Combination 11/16" 12 PT |
| J1270-24 | Wrench, Swivel Combination 3/4" 12 PT |
| J6016C | Wrench, Torque 1/2" DR 30-150 ft-lbs |



SUB SETS

Product #: J99905



Weight: 32.2 lbs.

| Contents | Description |
|-----------|--|
| J5268 | Extension, Flex 3/8" DR 8" |
| J1308PD | Hammer, Ball Pein 8 oz. |
| J1368 | Mallet, Rubber |
| J9206 | Nut Driver, 3/16" |
| J9207 | Nut Driver, 7/32" |
| J9208 | Nut Driver, 1/4" |
| J9209 | Nut Driver, 9/32" |
| J9210 | Nut Driver, 5/16" |
| J9211 | Nut Driver, 11/32" |
| J9212 | Nut Driver, 3/8" |
| J9214 | Nut Driver 7/16" |
| J9216 | Nut Driver, 1/2" |
| J9218 | Nut Driver, 9/16" |
| J9220 | Nut Driver, 5/8" |
| J206G | Pliers, Diagonal Cutting with Grip 6-1/16" |
| J291NC | Pliers, Locking Straight 7" |
| J222G | Pliers, Needle-Nose Long Thin 6-1/16" |
| J276G | Pliers, Slip-Joint with Grip 6-9/16" |
| J5257F | Ratchet, 3/8" DR Flex-Head 2-1/16" |
| J88204 | Screwdriver, Slotted Cabinet, Round 1/8" x 4" |
| J88203 | Screwdriver, Slotted Cabinet, Round 1/8" x 3" |
| J88208 | Screwdriver, Slotted Cabinet, Round 1/8" x 8" |
| J88214 | Screwdriver, Slotted Cabinet, Round 3/16" x 4" |
| J88218 | Screwdriver, Slotted Cabinet, Round 3/16" x 8" |
| J88393 | Screwdriver, Phillips® #0 |
| J88313 | Screwdriver, Phillips® #1 |
| J88318 | Screwdriver, Phillips® #1 |
| J88322 | Screwdriver, Phillips® #2 |
| J88324 | Screwdriver, Phillips® #2 |
| J88328 | Screwdriver, Phillips® #2 |
| J88336 | Screwdriver, Phillips® #3 |
| J88348 | Screwdriver, Phillips® #4 |
| J88102 | Screwdriver, Slotted Keystone, Square 1/4" x 2" |
| J88104 | Screwdriver, Slotted Keystone, Square 1/4" x 4" |
| J88106 | Screwdriver, Slotted Keystone, Square 1/4" x 6" |
| J88108 | Screwdriver, Slotted Keystone, Square 1/4" x 8" |
| J88112 | Screwdriver, Slotted Keystone, Square 1/4" x 12" |
| J88002 | Screwdriver, Slotted Keystone, Round 1/4" x 1-1/2" |
| J47701/16 | Socket, Hex Bit 1/4" DR 1/16" |
| J47705/64 | Socket, Hex Bit 1/4" DR 5/64" |
| J47703/32 | Socket, Hex Bit 1/4" DR 3/32" |
| J47707/64 | Socket, Hex Bit 1/4" DR 7/64" |
| J47701/8 | Socket, Hex Bit 1/4" DR 1/8" |
| J47709/64 | Socket, Hex Bit 1/4" DR 9/64" |
| J47705/32 | Socket, Hex Bit 1/4" DR 5/32" |
| J47703/16 | Socket, Hex Bit 1/4" DR 3/16" |

| Contents | Description |
|------------|---------------------------------------|
| J47707/32 | Socket, Hex Bit 1/4" DR 7/32" |
| J47701/4 | Socket, Hex Bit 1/4" DR 1/4" |
| J47705/16 | Socket, Hex Bit 1/4" DR 5/16" |
| J4770-2M | Socket, Hex Bit 1/4" DR 2 mm |
| J4770-2.5M | Socket, Hex Bit 1/4" DR 2.5 mm |
| J4770-3M | Socket, Hex Bit 1/4" DR 3 mm |
| J4770-4M | Socket, Hex Bit 1/4" DR 4 mm |
| J4770-5M | Socket, Hex Bit 1/4" DR 5 mm |
| J4770-6M | Socket, Hex Bit 1/4" DR 6 mm |
| J4990-4M | Socket, Hex Bit 3/8" DR 4 mm |
| J4990-5M | Socket, Hex Bit 3/8" DR 5 mm |
| J4990-6M | Socket, Hex Bit 3/8" DR 6 mm |
| J4990-7M | Socket, Hex Bit 3/8" DR 7 mm |
| J4990-8M | Socket, Hex Bit 3/8" DR 8 mm |
| J4990-9M | Socket, Hex Bit 3/8" DR 9 mm |
| J4990-10M | Socket, Hex Bit 3/8" DR 10 mm |
| J5441-12M | Socket, Hex Bit 1/2" DR 12 mm |
| J5441-14M | Socket, Hex Bit 1/2" DR 14 mm |
| J5441-17M | Socket, Hex Bit 1/2" DR 17 mm |
| J4771TA | Socket, Universal 1/4" DR 1/4" 12 PT |
| J4772TA | Socket, Universal 1/4" DR 5/16" 12 PT |
| J4773TA | Socket, Universal 1/4" DR 3/8" 12 PT |
| J4774TA | Socket, Universal 1/4" DR 7/16" 12 PT |
| J706 | Wrench, Adjustable 6" |
| J710 | Wrench, Adjustable 10" |
| J3018 | Wrench, Open End 1/4" x 5/16" |
| J3020 | Wrench, Open End 3/8" x 5/16" |
| J3025 | Wrench, Open End 7/16" x 1/2" |
| J3026 | Wrench, Open End 1/2" x 9/16" |
| J3030 | Wrench, Open End 9/16" x 5/8" |
| J3031 | Wrench, Open End 5/8" x 3/4" |
| J3035 | Wrench, Open End 11/16" x 3/4" |
| J3040 | Wrench, Open End 13/16" x 7/8" |
| J3045 | Wrench, Open End 15/16" x 1" |
| J3050 | Wrench, Open End 1-1/16" x 1-1/8" |
| J30607 | Wrench, Open End 6 mm x 7 mm |
| J30809 | Wrench, Open End 8 mm x 9 mm |
| J31011 | Wrench, Open End 10 mm x 11 mm |
| J31213 | Wrench, Open End 12 mm x 13 mm |
| J31415 | Wrench, Open End 14 mm x 15 mm |
| J31617 | Wrench, Open End 16 mm x 17 mm |
| J31819 | Wrench, Open End 18 mm x 19 mm |
| J32022 | Wrench, Open End 20 mm x 22 mm |
| J32123 | Wrench, Open End 21 mm x 23 mm |
| J32426 | Wrench, Open End 24 mm x 26 mm |
| J810HD | Wrench, Pipe Heavy-Duty 10" |



SUB SETS

Product #: J99915



► Weight: 110.3 lbs.

| Contents | Description |
|-------------|--|
| J5470A | Adapter, Universal Joint 1/2" DR |
| J86A3/16 | Chisel, Cold 1/4" |
| J86A1/4 | Chisel, Cold 5/16" |
| J86A5/16 | Chisel, Cold 3/8" |
| J86A7/16 | Chisel, Cold 1/2" |
| J86A1/2 | Chisel, Cold 5/8" |
| J86A5/8 | Chisel, Cold 3/4" |
| J86A3/4X8 | Chisel, Cold 7/8" |
| J86A7/8X8 | Chisel, Cold 1" |
| J86A1X8 | Chisel, Cold 1-3/16" |
| J9521 | Extractor, Screw 1/8" |
| J9522 | Extractor, Screw 3/16" |
| J9523 | Extractor, Screw 15/64" |
| J9524 | Extractor, Screw 5/16" |
| J9525 | Extractor, Screw 3/8" |
| J9525B | Extractor, Screw 15/32" |
| J9526 | Extractor, Screw 9/16" |
| J9527 | Extractor, Screw 21/32" |
| J9528 | Extractor, Screw 13/16" |
| J9529 | Extractor, Screw 1-1/16" |
| J5460 | Extension, 1/2" DR 2-1/2" |
| J5461 | Extension, 1/2" DR 5" |
| J5463 | Extension, 1/2" DR 10" |
| J5260W | Extension, Wobble 3/8" DR 3" |
| J5260-06W | Extension, Wobble 3/8" DR 6" |
| 15-265 | Hacksaw, 3-7/8" |
| 57-532 | Hammer, Compo-Cast® 21 oz. |
| J1430-HB | Hammer Head |
| J5468 | Handle, Hinge 1/2" DR |
| J5485 | Handle, Sliding T 1/2" DR |
| J5480G | Handle, Speed 1/2" DR |
| J4984 | Hex Key, 9 PC Metric Set |
| J4980 | Hex Key, 13 PC Standard Set |
| J2108 | Holder, Punch and Chisel |
| 10-099 | Knife, Stanley® Classic 99® Retractable Blade Utility |
| J2373 | Mirror, Rectangular Telescoping 2-1/8" |
| J209G | Pliers, Diagonal Cutting with Grip 7-5/16" |
| J227G | Pliers, Duckbill with Grip 7-25/32" |
| J272G | Pliers, End Cutting High Leverage 8-1/4" |
| J268G | Pliers, Lineman's with Grip 8-5/8" |
| J292NC | Pliers, Locking Curved 10" |
| J225G | Pliers, Needle-Nose Bent Nose 6-5/16" |
| J226G | Pliers, Needle-Nose with Cutter 6-5/8" |
| J298 | Pliers, Wire Strippers 8-1/4" |
| J413/8 | Punch, Center 3/8" |
| J411/2 | Punch, Center 1/2" |
| J965/16 | Punch, Drift 1/8" |
| J961/2 | Punch, Drift 1/4" |
| J963/8 | Punch, Drift 3/16" |
| J471/4X3/32 | Punch, Pin 3/32" |
| J475/16X1/8 | Punch, Pin 1/8" |
| J473/8X3/16 | Punch, Pin 3/16" |
| J471/2X1/4 | Punch, Pin 1/4" |

| Contents | Description |
|--------------|-------------------------------------|
| J475/16X5/32 | Punch, Pin 5/32" |
| J477/16X7/32 | Punch, Pin 7/32" |
| J445/16 | Punch, Prick 5/16" |
| J501/4 | Punch, Starting 3/32" |
| J505/16 | Punch, Starting 1/8" |
| J503/8 | Punch, Starting 3/16" |
| J507/16 | Punch, Starting 7/32" |
| J501/2 | Punch, Starting 1/4" |
| J5449 | Ratchet, 1/2" DR |
| J5450 | Ratchet, 1/2" DR (Long Handle) |
| J5447 | Ratchet, Adapter 1/2" DR 2/1-16" |
| J5457F | Ratchet, 1/2" DR Flex-Head 17-3/32" |
| J2375 | Retrieval Tool, Pocket Magnetic |
| J303S | Snips, Aviation Straight |
| J5412S | Socket, 1/2" DR 3/8" 8 PT |
| J5414S | Socket, 1/2" DR 7/16" 8 PT |
| J5416S | Socket, 1/2" DR 1/2" 8 PT |
| J5418S | Socket, 1/2" DR 9/16" 8 PT |
| J5420S | Socket, 1/2" DR 5/8" 8 PT |
| J5422S | Socket, 1/2" DR 11/16" 8 PT |
| J5424S | Socket, 1/2" DR 3/4" 8 PT |
| J5426S | Socket, 1/2" DR 13/16" 8 PT |
| J5428S | Socket, 1/2" DR 7/8" 8 PT |
| J5430 | Socket, 1/2" DR 15/16" 12 PT |
| J5432S | Socket, 1/2" DR 1" 8 PT |
| J5412 | Socket, 1/2" DR 3/8" 12 PT |
| J5414 | Socket, 1/2" DR 7/16" 12 PT |
| J5416 | Socket, 1/2" DR 1/2" 12 PT |
| J5418 | Socket, 1/2" DR 9/16" 12 PT |
| J5419 | Socket, 1/2" DR 19/32" 12 PT |
| J5420 | Socket, 1/2" DR 5/8" 12 PT |
| J5422 | Socket, 1/2" DR 11/16" 12 PT |
| J5424 | Socket, 1/2" DR 3/4" 12 PT |
| J5425 | Socket, 1/2" DR 25/32" 12 PT |
| J5426 | Socket, 1/2" DR 13/16" 12 PT |
| J5428 | Socket, 1/2" DR 7/8" 12 PT |
| J5429 | Socket, 1/2" DR 29/32" 12 PT |
| J5432 | Socket, 1/2" DR 1" 12 PT |
| J5434 | Socket, 1/2" DR 1-1/16" 12 PT |
| J5436 | Socket, 1/2" DR 1-1/8" 12 PT |
| J5438 | Socket, 1/2" DR 1-3/16" 12 PT |
| J5440 | Socket, 1/2" DR 1-1/4" 12 PT |
| J5442 | Socket, 1/2" DR 1-5/16" 12 PT |
| J5444 | Socket, 1/2" DR 1-3/8" 12 PT |
| J5446 | Socket, 1/2" DR 1-7/16" 12 PT |
| J5448 | Socket, 1/2" DR 1-1/2" 12 PT |
| J5410M | Socket, 1/2" DR 10 mm 12 PT |
| J5411M | Socket, 1/2" DR 11 mm 12 PT |
| J5412M | Socket, 1/2" DR 12 mm 12 PT |
| J5413M | Socket, 1/2" DR 13 mm 12 PT |
| J5414M | Socket, 1/2" DR 14 mm 12 PT |
| J5415M | Socket, 1/2" DR 15 mm 12 PT |
| J5416M | Socket, 1/2" DR 16 mm 12 PT |
| J5417M | Socket, 1/2" DR 17 mm 12 PT |





| Contents | Description |
|-----------|---|
| J5418M | Socket, 1/2" DR 18 mm 12 PT |
| J5419M | Socket, 1/2" DR 19 mm 12 PT |
| J5420M | Socket, 1/2" DR 20 mm 12 PT |
| J5421M | Socket, 1/2" DR 21 mm 12 PT |
| J5422M | Socket, 1/2" DR 22 mm 12 PT |
| J5423M | Socket, 1/2" DR 23 mm 12 PT |
| J5424M | Socket, 1/2" DR 24 mm 12 PT |
| J5316 | Socket, 1/2" DR 1/2" 12 PT Deep |
| J5318 | Socket, 1/2" DR 9/16" 12 PT Deep |
| J5320 | Socket, 1/2" DR 5/8" 12 PT Deep |
| J5322 | Socket, 1/2" DR 11/16" 12 PT Deep |
| J5324 | Socket, 1/2" DR 3/4" 12 PT Deep |
| J5326 | Socket, 1/2" DR 13/16" 12 PT Deep |
| J5328 | Socket, 1/2" DR 7/8" 12 PT Deep |
| J5330 | Socket, 1/2" DR 15/16" 12 PT Deep |
| J5332 | Socket, 1/2" DR 1" 12 PT Deep |
| J5334 | Socket, 1/2" DR 1-1/16" 12 PT Deep |
| J5336 | Socket, 1/2" DR 1-1/8" 12 PT Deep |
| J5340 | Socket, 1/2" DR 1-1/4" 12 PT Deep |
| J5444A | Socket, 1/2" DR Drag Link |
| J54411/4 | Socket, Hex Bit 1/2" DR 1/4" |
| J54415/16 | Socket, Hex Bit 1/2" DR 5/16" |
| J54413/8 | Socket, Hex Bit 1/2" DR 3/8" |
| J54417/16 | Socket, Hex Bit 1/2" DR 7/16" |
| J54411/2 | Socket, Hex Bit 1/2" DR 1/2" |
| J54419/16 | Socket, Hex Bit 1/2" DR 9/16" |
| J54415/8 | Socket, Hex Bit 1/2" DR 5/8" |
| 33-212 | Tape Rule, Stanley® Powerlock® with Metal Case 1/2" x 12' |
| J5475A | Socket, Universal 1/2 DR 1/2 12 PT |
| J5476A | Socket, Universal 1/2 DR 9/16 12 PT |
| J5477A | Socket, Universal 1/2 DR 5/8 12 PT |
| J1170 | Wrench, Box 5/16" x 3/8" 12 PT |
| J1171 | Wrench, Box 7/16" x 1/2" 12 PT |
| J1172 | Wrench, Box 9/16" x 5/8" 12 PT |
| J1173 | Wrench, Box 11/16" x 3/4" 12 PT |
| J1174 | Wrench, Box 13/16" x 7/8" 12 PT |
| J1175 | Wrench, Box 15/16" x 1" 12 PT |
| J1176 | Wrench, Box 1-1/16" x 1-1/8" 12 PT |
| J1050M | Wrench, Box 6 x 7 mm 12 PT |
| J1051M | Wrench, Box 8 x 9 mm 12 PT |
| J1053M | Wrench, Box 10 x 11 mm 12 PT |
| J1057M | Wrench, Box 12 x 13 mm 12 PT |
| J1061M | Wrench, Box 14 x 15 mm 12 PT |
| J1064M | Wrench, Box 16 x 18 mm 12 PT |
| J1065M | Wrench, Box 17 x 19 mm 12 PT |
| J1072M | Wrench, Box 21 x 24 mm 12 PT |
| J1073M | Wrench, Box 22 x 24 mm 12 PT |
| J1077M | Wrench, Box 27 x 30 mm 12 PT |
| J1079M | Wrench, Box 30 x 32 mm 12 PT |
| J1244 | Wrench, Combination 1-3/8" 12 PT |
| J1242 | Wrench, Combination 1-5/16" 12 PT |

| Contents | Description |
|-----------|--|
| J1246 | Wrench, Combination 1-7/16" 12 PT |
| J1248 | Wrench, Combination 1-1/2" 12 PT |
| J4912CF | Wrench, Crowfoot 3/8" DR 3/8" Open End |
| J4914CF | Wrench, Crowfoot 3/8" DR 7/16" Open End |
| J4916CF | Wrench, Crowfoot 3/8" DR 1/2" Open End |
| J4918CF | Wrench, Crowfoot 3/8" DR 9/16" Open End |
| J4920CF | Wrench, Crowfoot 3/8" DR 5/8" Open End |
| J4922CF | Wrench, Crowfoot 3/8" DR 11/16" Open End |
| J4924CF | Wrench, Crowfoot 3/8" DR 3/4" Open End |
| J4926CF | Wrench, Crowfoot 3/8" DR 13/16" Open End |
| J4928CF | Wrench, Crowfoot 3/8" DR 7/8" Open End |
| J4909MCF | Wrench, Crowfoot 3/8" DR 9 mm Open End |
| J4910MCF | Wrench, Crowfoot 3/8" DR 10 mm Open End |
| J4911MCF | Wrench, Crowfoot 3/8" DR 11 mm Open End |
| J4912MCF | Wrench, Crowfoot 3/8" DR 12 mm Open End |
| J4913MCF | Wrench, Crowfoot 3/8" DR 13 mm Open End |
| J4914MCF | Wrench, Crowfoot 3/8" DR 14 mm Open End |
| J4915MCF | Wrench, Crowfoot 3/8" DR 15 mm Open End |
| J4916MCF | Wrench, Crowfoot 3/8" DR 16 mm Open End |
| J4917MCF | Wrench, Crowfoot 3/8" DR 17 mm Open End |
| J4918MCF | Wrench, Crowfoot 3/8" DR 18 mm Open End |
| J4919MCF | Wrench, Crowfoot 3/8" DR 19 mm Open End |
| J4920MCF | Wrench, Crowfoot 3/8" DR 20 mm Open End |
| J4921MCF | Wrench, Crowfoot 3/8" DR 21 mm Open End |
| J4922MCF | Wrench, Crowfoot 3/8" DR 22 mm Open End |
| J4923MCF | Wrench, Crowfoot 3/8" DR 23 mm Open End |
| J4924MCF | Wrench, Crowfoot 3/8" DR 24 mm Open End |
| J3751 | Wrench, Flare Nut Combination 3/8" 6 PT |
| J3752 | Wrench, Flare Nut Combination 7/16" 6 PT |
| J3753 | Wrench, Flare Nut Combination 1/2" 6 PT |
| J3754 | Wrench, Flare Nut Combination 9/16" 6 PT |
| J3755 | Wrench, Flare Nut Combination 5/8" 6 PT |
| J3756 | Wrench, Flare Nut Combination 11/16" 6 PT |
| J3757 | Wrench, Flare Nut Combination 3/4" 6 PT |
| J3707M | Wrench, Flare Nut 7 mm x 8 mm |
| J3709M | Wrench, Flare Nut 9 mm x 11 mm |
| J3710M | Wrench, Flare Nut 10 mm x 12 mm |
| J3713M | Wrench, Flare Nut 13 mm x 14 mm |
| J3715M | Wrench, Flare Nut 15 mm x 17 mm |
| J814HD | Wrench, Pipe Heavy-Duty 14" |
| J1191T-A | Wrench, Ratcheting Box 1/4" x 5/16" 12 PT |
| J1192T-A | Wrench, Ratcheting Box 3/8" x 7/16" 12 PT |
| J1193T-A | Wrench, Ratcheting Box 1/2" x 9/16" 12 PT |
| J1194-A | Wrench, Ratcheting Box 5/8" x 11/16" 12 PT |
| J1195-A | Wrench, Ratcheting Box 3/4" x 7/8" 12 PT |
| J1191M-A | Wrench, Ratcheting Box 7 mm x 8 mm |
| J1192M-A | Wrench, Ratcheting Box 9 mm x 10 mm |
| J1193MA-A | Wrench, Ratcheting Box 11 mm x 12 mm |
| J1194MA-A | Wrench, Ratcheting Box 13 mm x 14 mm |
| J1195M-A | Wrench, Ratcheting Box 15 mm x 17 mm |
| J6014C | Wrench, Torque 1/2" DR 50-250 ft-lbs |

SUB SETS

Product #: J99675



► Weight: 297.1 lbs.

| Contents | Description |
|-----------|--|
| J2126 | Bar, 12" Long 1/2" Tip |
| J2130 | Bar, 16" Long 5/8" Tip |
| J2120 | Bar, Pry Aligning 18" |
| J2124 | Bar, Pry Aligning 24" |
| J404 | C-Clamps, Capacity 0"-4", 2 Each |
| J9521 | Extractor, Screw 1/8" |
| J9522 | Extractor, Screw 3/16" |
| J9523 | Extractor, Screw 15/64" |
| J9524 | Extractor, Screw 5/16" |
| J9525 | Extractor, Screw 3/8" |
| J9525B | Extractor, Screw 15/32" |
| J9526 | Extractor, Screw 9/16" |
| J9527 | Extractor, Screw 21/32" |
| J9528 | Extractor, Screw 13/16" |
| J9529 | Extractor, Screw 1-1/16" |
| J5660 | Extension, 3/4" DR 4" |
| J5661 | Extension, 3/4" DR 8" |
| J5663 | Extension, 3/4" DR 16" |
| J5260W | Extension, Wobble 3/8" DR 3" |
| J5260-06W | Extension, Wobble 3/8" DR 6" |
| J5696 | Box, Extra Heavy-Duty Set |
| J1430-HB | Hammer Head |
| J1332PD | Hammer, Ball Pein 32 oz. |
| 57-532 | Hammer, Compo-Cast® 21 oz. |
| 57-534 | Hammer, Compo-Cast® 52 oz. |
| J5668 | Handle, Hinge 3/4" DR 20" |
| J5685 | Handle, Sliding T 3/4" DR |
| J2373 | Mirror, Rectangular Telescoping 2-1/8" |
| J227G | Pliers, Duckbill with Grip 7-25/32" |
| J292NC | Pliers, Locking Curved 10" |
| J286LNXL | Pliers, Locking Mini Long Nose 6-29/32" |
| J226G | Pliers, Needle-Nose with Cutter 6-5/8" |
| J261SG | Pliers, Tongue and Groove 5" with Grip |
| J262SG | Pliers, Tongue and Groove 6-1/2" with Grip |
| J260SG | Pliers, Tongue and Groove 10-3/16" with Grip |
| J265SG | Pliers, Tongue and Groove 16" with Grip |
| J298 | Pliers, Wire Strippers 8-1/4" |
| J2306 | Puller, Cotter Pin Tool |
| J4056-4 | Puller, Jaw Reversible 4 R |
| J4250N | Puller, Nut Adjustable Reversible |
| J4056PN | Puller, Pin Pivot |
| J4205S | Puller, Screw Forcing Acme |
| J360B | Pliers, 12 PC Set Convertible Retaining Ring |
| J4022T | Puller, Tip Detachable Standard |
| J4255B | Puller, Yoke 3 Way Jaw ACM |
| J5649 | Ratchet, 3/4" DR |
| J5257F | Ratchet, 3/8" DR Flex-Head 2-1/16" |
| J5457F | Ratchet, 1/2" DR Flex-Head 17-3/32" |
| J2375 | Retrieval Tool, Pocket Magnetic |
| 28-240 | Scraper, Flexible Nylon 1-1/4" |
| 28-540 | Scraper, Flexible 1-1/4" Wood Handle |
| J2336 | Scrapers, Gasket and Carbon |
| J9884 | Screw Starter, Phillips® Tip |

| Contents | Description |
|----------|---|
| J9853 | Screw Starter, Standard Tip |
| J322 | Snips, Straight 12-3/4" |
| J308 | Snips, Miniature |
| J5446A | Socket, 1/2" DR Drag Link |
| J5528 | Socket, 3/4" DR 7/8" 12 PT |
| J5530 | Socket, 3/4" DR 15/16" 12 PT |
| J5532 | Socket, 3/4" DR 1" 12 PT |
| J5534 | Socket, 3/4" DR 1-1/16" 12 PT |
| J5536 | Socket, 3/4" DR 1-1/8" 12 PT |
| J5538 | Socket, 3/4" DR 1-3/16" 12 PT |
| J5540 | Socket, 3/4" DR 1-1/4" 12 PT |
| J5542 | Socket, 3/4" DR 1-5/16" 12 PT |
| J5544 | Socket, 3/4" DR 1-3/8" 12 PT |
| J5546 | Socket, 3/4" DR 1-7/16" 12 PT |
| J5548 | Socket, 3/4" DR 1-1/2" 12 PT |
| J5550 | Socket, 3/4" DR 1-9/16" 12 PT |
| J5552 | Socket, 3/4" DR 1-5/8" 12 PT |
| J5554 | Socket, 3/4" DR 1-11/16" 12 PT |
| J5556 | Socket, 3/4" DR 1-3/4" 12 PT |
| J5558 | Socket, 3/4" DR 1-13/16" 12 PT |
| J5560 | Socket, 3/4" DR 1-7/8" 12 PT |
| J5564 | Socket, 3/4" DR 2" 12 PT |
| J5568 | Socket, 3/4" DR 2-1/8" 12 PT |
| J5570 | Socket, 3/4" DR 2-3/16" 12 PT |
| J5572 | Socket, 3/4" DR 2-1/4" 12 PT |
| J5576 | Socket, 3/4" DR 2-3/8" 12 PT |
| 33-212 | Tape Rule, Stanley® Powerlock® with Metal Case 1/2" x 12' |
| J5670 | Adapter, Universal Joint 3/4" DR |
| J712 | Wrench, Adjustable 12" |
| J715 | Wrench, Adjustable 15" |
| J3314 | Wrench, Angle 7/32" |
| J3316 | Wrench, Angle 1/4" |
| J3315 | Wrench, Angle 15/64" |
| J3318 | Wrench, Angle 9/32" |
| J3320 | Wrench, Angle 5/16" |
| J3322 | Wrench, Angle 11/32" |
| J3324 | Wrench, Angle 3/8" |
| J3328 | Wrench, Angle 7/16" |
| J3332 | Wrench, Angle 1/2" |
| J1170 | Wrench, Box 5/16" x 3/8" 12 PT |
| J1171 | Wrench, Box 7/16" x 1/2" 12 PT |
| J1172 | Wrench, Box 9/16" x 5/8" 12 PT |
| J1173 | Wrench, Box 11/16" x 3/4" 12 PT |
| J1174 | Wrench, Box 13/16" x 7/8" 12 PT |
| J1175 | Wrench, Box 15/16" x 1" 12 PT |
| J1176 | Wrench, Box 1-1/16" x 1-1/8" 12 PT |
| J1120 | Wrench, Box 5/16" x 3/8" 12 PT Short |
| J1122 | Wrench, Box 3/8" x 7/16" 12 PT Short |
| J1126 | Wrench, Box 1/2" x 9/16" 12 PT Short |
| J1131 | Wrench, Box 5/8" x 3/4" 12 PT Short |
| J801 | Wrench, Chain |
| J1242 | Wrench, Combination 1-5/16" 12 PT |





| Contents | Description | Contents | Description |
|----------|--|----------|--|
| J1244 | Wrench, Combination 1-3/8" 12 PT | J3824 | Wrench, Flare Nut Ratcheting 3/4" |
| J1246 | Wrench, Combination 1-7/16" 12 PT | J1725 | Wrench, Obstruction 7/16" x 1/2" |
| J1248 | Wrench, Combination 1-1/2" 12 PT | J1730 | Wrench, Obstruction 9/16" x 5/8" |
| J4912CF | Wrench, Crowfoot 3/8" DR 3/8" Open End | J1731 | Wrench, Obstruction 5/8" x 3/4" |
| J4914CF | Wrench, Crowfoot 3/8" DR 7/16" Open End | J814HD | Wrench, Pipe Heavy-Duty 14" |
| J4916CF | Wrench, Crowfoot 3/8" DR 1/2" Open End | J818HD | Wrench, Pipe Heavy-Duty 18" |
| J4918CF | Wrench, Crowfoot 3/8" DR 9/16" Open End | J1191T-A | Wrench, Ratcheting Box 1/4" x 5/16" 12 PT |
| J4920CF | Wrench, Crowfoot 3/8" DR 5/8" Open End | J1192T-A | Wrench, Ratcheting Box 3/8" x 7/16" 12 PT |
| J4922CF | Wrench, Crowfoot 3/8" DR 11/16" Open End | J1193T-A | Wrench, Ratcheting Box 1/2" x 9/16" 12 PT |
| J4924CF | Wrench, Crowfoot 3/8" DR 3/4" Open End | J1194-A | Wrench, Ratcheting Box 5/8" x 11/16" 12 PT |
| J4926CF | Wrench, Crowfoot 3/8" DR 13/16" Open End | J1195-A | Wrench, Ratcheting Box 3/4" x 7/8" 12 PT |
| J4928CF | Wrench, Crowfoot 3/8" DR 7/8" Open End | J1270-12 | Wrench, Swivel Combination 3/8" 12 PT |
| J3812 | Wrench, Flare Nut Ratcheting 3/8" | J1270-14 | Wrench, Swivel Combination 7/16" 12 PT |
| J3814 | Wrench, Flare Nut Ratcheting 7/16" | J1270-16 | Wrench, Swivel Combination 1/2" 12 PT |
| J3820 | Wrench, Flare Nut Ratcheting 5/8" | J1270-18 | Wrench, Swivel Combination 9/16" 12 PT |
| J3816 | Wrench, Flare Nut Ratcheting 1/2" | J1270-20 | Wrench, Swivel Combination 5/8" 12 PT |
| J3818 | Wrench, Flare Nut Ratcheting 9/16" | J1270-22 | Wrench, Swivel Combination 11/16" 12 PT |
| J3822 | Wrench, Flare Nut Ratcheting 11/16" | J1270-24 | Wrench, Swivel Combination 3/4" 12 PT |

PROTO® MASTER SET CONVERSION CHART

| Product ID No. | # of Pieces | Description | Suggested Replacement | # of Pieces | Description |
|----------------|-------------|--|-----------------------|-------------|--|
| J99950 | 1026 | Master Technician Maintenance Set | JCS-1046MAS | 1046 | Master Technician Maintenance Set |
| J99951 | 1026 | Master Technician Maintenance Set With Box | JCS-1046MASBX1 | 1046 | Master Technician Maintenance Set With Box |
| J99952 | 1026 | Master Technician Maintenance Set With Box | JCS-1046MASBX2 | 1046 | Master Technician Maintenance Set With Box |
| J99940 | 821 | Master Technician Maintenance Set | JCS-0833MAS | 833 | Master Technician Maintenance Set |
| J99941 | 821 | Master Technician Maintenance Set With Box | JCS-0833MASBX1 | 833 | Master Technician Maintenance Set With Box |
| J99942 | 821 | Master Technician Maintenance Set With Box | JCS-0833MASBX2 | 833 | Master Technician Maintenance Set With Box |
| J99930 | 613 | Master Technician Maintenance Set | JCS-0613MAS | 613 | Master Technician Maintenance Set |
| J99931 | 613 | Master Technician Maintenance Set With Box | JCS-0613MASBX1 | 613 | Master Technician Maintenance Set With Box |
| J99932 | 613 | Master Technician Maintenance Set With Box | JCS-0613MASBX2 | 613 | Master Technician Maintenance Set With Box |
| J99670 | 254 | Advanced Maintenance Set | JCS-0334MAS | 334 | Advanced Maintenance Set |
| J99671 | 254 | Advanced Maintenance Set With Box | JCS-0334MASBX1 | 334 | Advanced Maintenance Set With Box |
| J99672 | 254 | Advanced Maintenance Set With Box | JCS-0334MASBX2 | 334 | Advanced Maintenance Set With Box |
| J99560 | 355 | Metric Master Set | JCS-0558MAS | 558 | Metric Master Set |
| J99561 | 355 | Metric Master Set With Box | JCS-0558MASBX2 | 558 | Metric Master Set With Box |
| J99562 | 355 | Metric Master Set With Box | JCS-0558MASBX1 | 558 | Metric Master Set With Box |
| J98240 | 111 | Avionics Technician's Set | JTS-0149AVI | 149 | Avionics Technician's Set |
| J98241 | 111 | Avionics Technician's Set With Box | JTS-0149AVIBX1 | 149 | Avionics Technician's Set With Box |
| J98220 | 99 | Aircraft Mechanic's Starter Set | JTS-0116AIR | 116 | Aircraft Mechanic's Starter Set |
| J98200 | 264 | Aircraft Maintenance Set | JTS-0411AIR | 411 | Aircraft Maintenance Set |
| J98201 | 264 | Aircraft Maintenance Set With Box | JTS-0411AIRBX2 | 411 | Aircraft Maintenance Set With Box |
| J98202 | 264 | Aircraft Maintenance Set With Box | JTS-0411AIRBX1 | 411 | Aircraft Maintenance Set With Box |
| J98140 | 40 | Railroad Carman's Set | JTS-0067RR | 67 | Railroad Carman's Set |
| J98141 | 40 | Railroad Carman's Set With Box | JTS-0067RRBX1 | 67 | Railroad Carman's Set With Box |
| J98130 | 80 | Railroad Pipefitter's Set | JTS-0107RR | 107 | Railroad Pipefitter's Set |
| J98131 | 80 | Railroad Pipefitter's Set With Box | JTS-0107RRBX1 | 107 | Railroad Pipefitter's Set With Box |
| J98120 | 80 | Railroad Machinist's Set | JTS-0089RR | 89 | Railroad Machinist's Set |
| J98121 | 80 | Railroad Machinist's Set With Box | JTS-0089RRBX1 | 89 | Railroad Machinist's Set With Box |
| J98110 | 129 | Railroad Electrician's Set | JTS-0141RR | 141 | Railroad Electrician's Set |
| J98111 | 129 | Railroad Electrician's Set With Box | JTS-0141RRBX1 | 141 | Railroad Electrician's Set With Box |
| J98100 | 156 | Railroad Roadway Mechanic's Set | JTS-0172RR | 172 | Railroad Roadway Mechanic's Set |
| J98101 | 156 | Railroad Roadway Mechanic's Set With Box | JTS-0172RRBX1 | 172 | Railroad Roadway Mechanic's Set With Box |
| 90-732 | 19 | Electrician's Tool Set | JTS-0025ELEC | 25 | Electrician's Tool Set |
| 90-731 | 23 | Plumber's Tool Set | JTS-0037PLUM | 37 | Plumber's Tool Set |
| 90-730 | 21 | Contractor's Tool Set | JTS-0030CONT | 30 | Contractor's Tool Set |



PROTO



RATCHETS ARE THE MOST-USED TOOLS IN ANY BOX. ESPECIALLY WHEN THEY'RE STAMPED PROTO®.

Our drive tools are super efficient with features like pear-shaped heads that fit in tight spaces, reversing levers you can switch easily with one-hand and knurled grips to prevent slippage. Our sockets are strong and sure, whether you're talking the aerospace spline variety or our standard TorquePlus™ models that all but eliminate fastener rounding. And every ratchet and socket we make is crafted to resist corrosion, stand up to use and work flawlessly every time you reach for it. Which will likely be a million times and then some.

HAND SOCKETS, DRIVE TOOLS, AND ACCESSORIES



6 Point 1/4" Drive Hand Sockets

PROTO



TORQUEPLUS™ DELIVERS POWER WHERE YOU NEED IT

With TorquePlus™ technology, our sockets grip fasteners tighter than a conventional socket can, enabling you to solidly seat fasteners and more easily break stubborn fasteners free.

Engages fastener on the flats rather than on the corners.

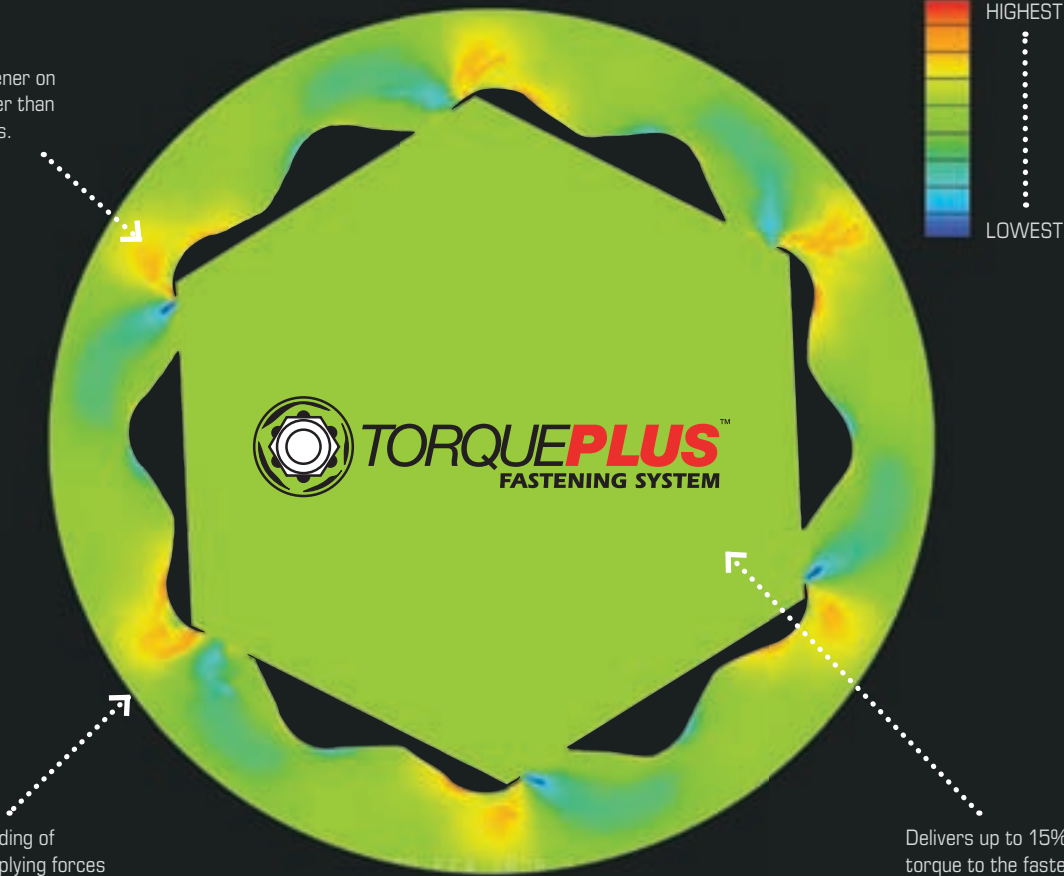

Reduces rounding of corners by applying forces over a larger surface area.

Delivers up to 15% more torque to the fastener shaft or nut.

CONVENTIONAL SOCKETS VS TORQUEPLUS™

The difference is in the points. A TorquePlus™ socket features rounded points which allow the socket walls to contact the fastener walls, keeping pressure off the points. This engineering change helps the socket find a longer, better grip on the flat of the fastener head. All Proto® hand sockets feature the innovative TorquePlus™ design.

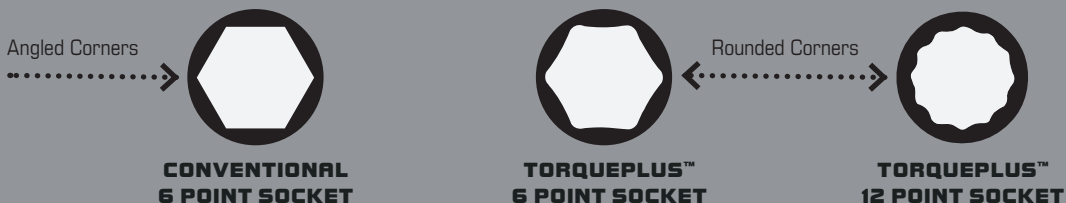

RATCHET GUIDE

STANDARD PEAR HEAD RATCHETS
24-tooth gear produces 15° arc per click.



PREMIUM PEAR RATCHETS
45-tooth gear produces 8° arc per click. Sealed ratchet head available with Quick Release button.



AEROSPACE RATCHETS
Vertical hole drilled through drive plug. Installs frangible collars onto threaded pins.



ROUND HEAD RATCHETS
72-tooth gear produces 5° arc for precision applications.



FEMALE DRIVE RATCHETS
Used on plug-end connectors like clamps, threading machines, and pipe-end caps.



FLEX-HEAD RATCHETS
Pivoting head to reach bolts at different angle.

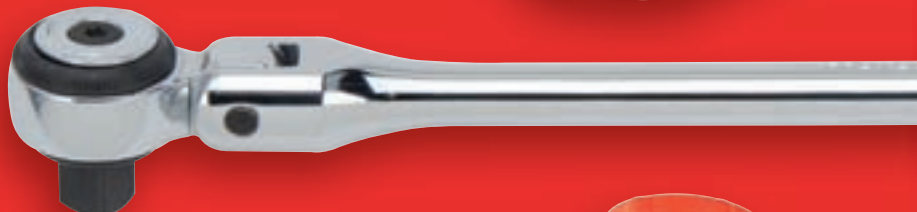

LONG-HANDLED RATCHETS
Various lengths for extra leverage.

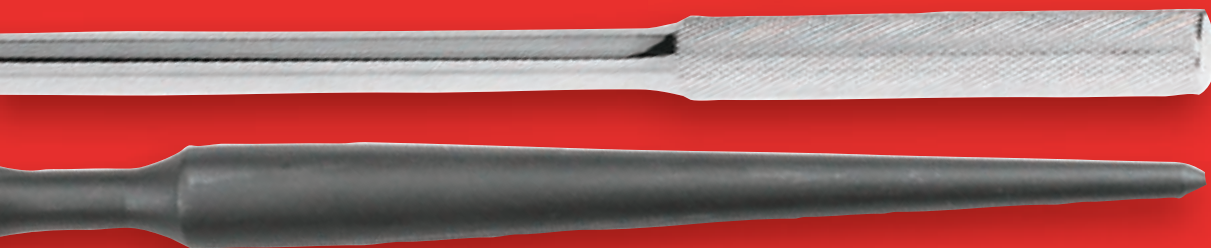

INSULATED RATCHETS
Insulated to 1000V AC or 1500V DC.

SPUD HANDLE RATCHETS
Lines up steel beams before the bolts are tightened.



SCAFFOLDING RATCHETS
Single-piece socket and drive tool with tether hole.



STUBBY RATCHETS
Used for tight quarters and enclosed spaces.

SOCKETS

We offer a wide range of socket sizes with different point counts to meet an equally wide range of job site needs. The right tool for the right job is frequently a very specific tool.



6 POINT



8 POINT



12 POINT

FINISHES

Finishes protect the tool from dirt, wear and light damage. Different finishes serve different goals and industry needs.

Polished Chrome

finish is the industry standard. We upgrade ours to meet aerospace standards where applicable.



Black Oxide is used where the threat of any chrome peeling or chipping might be an issue.



Satin Chrome is used in larger sizes. The finish has more grip and better handling, especially with gloved hands.



FRACTIONAL



METRIC



DEEP



SPLINE

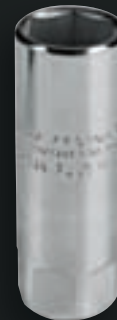

SPARK PLUG



UNIVERSAL

DRIVE SIZES: 1/4", 1/2", 3/4", 3/8" AND 1"

Manufactured to exceed ASME B107 specifications, Proto® sockets have a hardness rating of 47 to 51 HRC. Proto® leads the industry in the breadth and depth of its product line, and we have added more new sizes to our 1/2" Drive, 3/8" Drive and 1/4" Drive sockets.



SCREWDRIVER BITS

Allows ratchets to sink and remove fasteners quicker than standard screwdrivers. Most sets will have a good range of the standard bits, along with a mix of specialty ones.



SLOTTED

PHILLIPS®

TORX®

HEX BITS

Available in both metric and fractional sizes, Proto® Hex Bits also come in different lengths. The Ball End Hex Bit allows you to pivot as much as 15° in order to reach fasteners offset from the vertical.



BALL END

SHORT

MEDIUM

LONG

CROWFOOT

Frequently used where obstructions are an issue, a Crowfoot wrench, with a locking extension, can reach around pipes, tubes and rods that block direct access to the fastener.



OPEN END

FLARE NUT

**12 POINT
FLARE NUT**

INSULATED SOCKETS AND BITS

Used in electrical applications where it is not possible to power down the equipment being serviced. They must be used with insulated ratchets and extensions.



SOCKET

BITS



STANDARD LENGTH PREMIUM PEAR HEAD RATCHETS



- › Small pear head design for access in tight, hard to reach work areas.
- › 45-tooth gear provides balance between 8° articulation angle and high torque carrying capacity.
- › Sealed design helps prevent debris from entering the ratchet mechanism reducing wear. Also, helps to keep lubrication contained within the components. Patent pending design.
- › Low profile reversing lever design for quick, one-hand operation.
- › Contoured, ergonomically-designed handle for comfort. Knurled bands allow for increased grip and slip resistance.
- › Double nickel chrome plated for enhanced corrosion protection or black oxide finish.
- › Field repairable.



| Product # | Drive Size (in) | Finish | Overall Length (in) | Weight (lbs) | Repair Kit |
|------------------|-----------------|-------------|---------------------|--------------|------------|
| J4749XL | 1/4 | Full Polish | 5-45/64 | 0.25 | J4749XLRK |
| J4749XLBL | 1/4 | Black Oxide | 5-45/64 | 0.25 | J4749XLRK |
| J5249XL | 3/8 | Full Polish | 8-1/2 | 0.86 | J5249XLRK |
| J5249XLBL | 3/8 | Black Oxide | 8-1/2 | 0.87 | J5249XLRK |
| J5449XL | 1/2 | Full Polish | 10-1/2 | 1.72 | J5449XLRK |
| J5449XLBL | 1/2 | Black Oxide | 10-1/2 | 1.72 | J5449XLRK |

 ASME B107.500

QUICK RELEASE PREMIUM PEAR HEAD RATCHETS



- › Small, pear head design for access in tight, hard to reach work areas.
- › 45-tooth gear, 8° swing articulation.
- › Low profile quick release button for access in restricted areas.
- › Low profile reversing lever design for quick, one-hand operation.
- › Patented sealed head design helps prevent debris from entering the ratchet mechanism reducing wear. Also, helps to keep lubrication contained within the components.
- › Contoured, ergonomically-designed handle for comfort.
- › Knurled bands allow for increased grip and slip resistance.
- › Full polished handle, easy to clean.
- › Double nickel chrome plated for enhanced corrosion protection meeting aerospace requirements.
- › Field repairable.



| Product # | Drive Size (in) | Finish | Overall Length (in) | Weight (lbs) | Repair Kit |
|--------------------|-----------------|-------------|---------------------|--------------|-------------|
| J4749XLQR | 1/4 | Full Polish | 6-11/16 | 0.25 | J4749XLQRRK |
| J4749XLQRBL | 1/4 | Black Oxide | 6-11/16 | 0.25 | J4749XLQRRK |
| J5249XLQR | 3/8 | Full Polish | 8-1/2 | 0.86 | J5249XLQRRK |
| J5249XLQRBL | 3/8 | Black Oxide | 8-1/2 | 0.86 | J5249XLQRRK |
| J5449XLQR | 1/2 | Full Polish | 10-1/2 | 1.72 | J5449XLQRRK |
| J5449XLQRBL | 1/2 | Black Oxide | 10-1/2 | 1.72 | J5449XLQRRK |
| J5450XLQR | 1/2 | Full Polish | 15 | 2.18 | J5449XLQRRK |
| J5450XLQRBL | 1/2 | Black Oxide | 15 | 2.18 | J5449XLQRRK |

 ASME B107.10





LONG HANDLE PREMIUM PEAR HEAD RATCHETS

- › Small pear head design for access in tight, hard to reach work areas.
- › 45-tooth gear provides balance between 8° articulation angle and high torque carrying capacity.
- › Sealed design helps prevent debris from entering the ratchet mechanism reducing wear. Also, helps to keep lubrication contained within the components. Patent pending design.
- › Low profile reversing lever design for quick, one-hand operation.
- › Contoured, ergonomically-designed handle for comfort. Knurled bands allow for increased grip and slip resistance.
- › Double nickel chrome plated for enhanced corrosion protection or black oxide finish.
- › Field repairable.



| Product # | Drive Size (in) | Finish | Overall Length (in) | Weight (lbs) | Repair Kit |
|------------------|-----------------|-------------|---------------------|--------------|------------|
| J5250XL | 3/8 | Full Polish | 11 | 1.03 | J5249XLRK |
| J5250XLBL | 3/8 | Black Oxide | 11 | 0.98 | J5249XLRK |
| J5450XL | 1/2 | Full Polish | 15 | 2.18 | J5449XLRK |
| J5450XLBL | 1/2 | Black Oxide | 15 | 2.18 | J5449XLRK |



ASME B107.500

AEROSPACE PREMIUM PEAR HEAD RATCHETS

- › Vertical hole drilled in drive plug, designed for installation of frangible collars on threaded pins.
- › Unique 45-tooth gear pawl design provides 8° ratcheting angle while maximizing ultimate torque.
- › Thin head design for access into tight work areas.
- › Reversing lever designed for quick, one-hand operation.
- › Full polish nickel chrome plated.



| Product # | Drive Size (in) | Finish | Overall Length (in) | Weight (lbs) | Repair Kit |
|------------------|-----------------|-------------|---------------------|--------------|-------------|
| J4749XLHS | 1/4 | Full Polish | 5-45/64 | 0.25 | J4749XLHSRK |
| J5249XLHS | 3/8 | Full Polish | 8-1/2 | 0.86 | J5249XLHSRK |



ASME B107.500

AEROSPACE CLASSIC PEAR HEAD RATCHETS

- › Vertical hole drilled in drive plug, designed for installation of frangible collars on threaded pins.
- › Metal spring clip on drive plug for positive socket retention.
- › 24-tooth gear provides 15° articulation angle.
- › Thin head design for access into tight work areas.
- › Reversing lever designed for quick, one-hand operation.
- › Full polish double nickel chrome plated.



| Product # | Drive Size (in) | Finish | Overall Length (in) | Weight (lbs) | Repair Kit |
|----------------|-----------------|-------------|---------------------|--------------|------------|
| J4749HS | 1/4 | Full Polish | 5 | 0.25 | J4749RK |
| J5249HS | 3/8 | Full Polish | 7 | 0.62 | J5249HSRK |



ASME B107.500

STUBBY CLASSIC PEAR HEAD RATCHETS

- › Robust 24-tooth design with 15° arc swing.
- › Alloy steel drive gear for strength and durability.
- › Low profile head for access in constricted areas.
- › Reversing lever design for quick, one-hand operation.
- › Knurled slip-resistant grip.



| Product # | Drive Size (in) | Finish | Overall Length (in) | Weight (lbs) | Repair Kit |
|---------------|-----------------|-------------|---------------------|--------------|------------|
| J5248S | 3/8 | Full Polish | 5 | 0.28 | J5249RK |



ASME B107.500



STANDARD LENGTH CLASSIC PEAR HEAD RATCHETS

- › Robust 24-tooth gear/floating pawl design provides 15° ratcheting angle while maximizing ultimate torque.
- › Thin head design for access into tight work areas.
- › Reversing lever designed for quick, one-hand operation.



| Product # | Drive Size (in) | Finish | Overall Length (in) | Weight (lbs) | Repair Kit |
|----------------|-----------------|-------------|---------------------|--------------|------------|
| J4749 | 1/4 | Full Polish | 5 | 0.26 | J4749RK |
| J4749BL | 1/4 | Black Oxide | 5 | 0.24 | J4749RK |
| J5249 | 3/8 | Full Polish | 7 | 0.61 | J5249RK |
| J5249BL | 3/8 | Black Oxide | 7 | 0.62 | J5249RK |
| J5449 | 1/2 | Full Polish | 10 | 1.57 | J5449RK |
| J5449BL | 1/2 | Black Oxide | 10 | 1.74 | J5449RK |
| J5649 | 3/4 | Full Polish | 20 | 6.00 | J5649RK |
| J5649BL | 3/4 | Black Oxide | 20 | 6.00 | J5649RK |

 ASME B107.500

CLASSIC PEAR HEAD RATCHET WITH OVERSIZED REVERSE LEVER

- › Oversized reverse lever for easy reversing while wearing work gloves.
- › Reversing lever designed for quick one-hand operation.
- › Ideal ratchet for lineman operations.
- › Robust 24-tooth gear/floating pawl design provides 15° ratcheting angle while maximizing ultimate torque.



| Product # | Drive Size (in) | Finish | Overall Length (in) | Weight (lbs) | Repair Kit |
|----------------|-----------------|-------------|---------------------|--------------|------------|
| J5449UT | 1/2 | Full Polish | 10 | 1.50 | J5449UTRK |

 ASME B107.500

LONG HANDLE CLASSIC PEAR HEAD RATCHETS

- › Robust 24-tooth gear/floating pawl design provides 15° ratcheting angle while maximizing ultimate torque.
- › Alloy steel drive gear for strength and durability.
- › Low profile head for access in constricted areas.
- › Reversing lever design for quick, one-hand operation.
- › Knurled slip-resistant grip.



| Product # | Drive Size (in) | Finish | Overall Length (in) | Weight (lbs) | Repair Kit |
|----------------|-----------------|-------------|---------------------|--------------|------------|
| J5250 | 3/8 | Full Polish | 11 | 0.89 | J5249RK |
| J5250BL | 3/8 | Black Oxide | 11 | 0.81 | J5249RK |
| J5450 | 1/2 | Full Polish | 16 | 2.03 | J5449RK |
| J5450BL | 1/2 | Black Oxide | 16 | 2.03 | J5449RK |

 ASME B107.500





CLASSIC PEAR HEAD RATCHET - MALE/FEMALE

- › An extra safety factor is provided through the use of a spring-loaded pellet in each male drive plug that snaps into a hole in the drive end of the socket and acts as a retaining pin. The socket stays locked on until the pellet is depressed and the socket is removed.
- › Robust 24-tooth gear design provides 15° ratcheting angle while maximizing ultimate torque.
- › Thin head design for access into tight work areas.
- › Reversing lever designed for quick, one-hand operation.



| Product # | Drive Size (in) | Finish | Overall Length (in) | Weight (lbs) | Repair Kit |
|--------------|-----------------|-------------|---------------------|--------------|------------|
| J5849 | 1 | Full Polish | 26 | 13.02 | J5849RK |

ASME B107.500

FEMALE DRIVE RATCHETS

- › Robust 24-tooth design with 15° arc swing.
- › Alloy steel drive gear for strength and durability.
- › Low profile head for access in constricted areas.
- › Reversing lever design for quick, one-hand operation.
- › Knurled slip-resistant grip.
- › Made of heat-treated alloy steel.



| Product # | Drive Size (in) | Finish | Overall Length (in) | Weight (lbs) | Repair Kit |
|----------------|-----------------|-------------|---------------------|--------------|------------|
| J5249FW | 3/8 | Full Polish | 7 | 0.56 | J5249FWRK |
| J5450FW | 1/2 | Full Polish | 16 | 1.82 | J5450FWRK |
| J5649FW | 3/4 | Satin | 20 | 5.62 | J5649FWRK |

ASME B107.500

STANDARD LENGTH ROUND HEAD RATCHETS

- › Round head ratchet mechanism allows for a compact head.
- › 72-tooth = 5° swing arc.
- › Small head design and tight swing arc allow for fastener access in tight areas.
- › Full polish or black oxide finish with knurled grip for strong slip-resistant grip.



| Product # | Drive Size (in) | Finish | Overall Length (in) | Weight (lbs) | Repair Kit |
|-----------------|-----------------|-------------|---------------------|--------------|------------|
| J4752F | 1/4 | Full Polish | 4-1/2 | 0.26 | J4752FRK |
| J4752FBL | 1/4 | Black Oxide | 4-1/2 | 0.24 | J4752FRK |
| J5252F | 3/8 | Full Polish | 7-3/8 | 0.57 | J5252FRK |
| J5252FBL | 3/8 | Black Oxide | 7-3/8 | 0.57 | J5252FRK |
| J5452F | 1/2 | Full Polish | 9-3/8 | 1.12 | J5452FRK |
| J5452FBL | 1/2 | Black Oxide | 9-3/8 | 1.12 | J5452FRK |

ASME B107.500

LONG HANDLE ROUND HEAD RATCHET

- › Round head ratchet mechanism allows for a compact head.
- › 72-tooth = 5° swing arc.
- › Small head design and tight swing arc allow for fastener access in tight areas.
- › Full polish shaft with knurled grip for strong slip-resistant grip.



| Product # | Drive Size (in) | Finish | Overall Length (in) | Weight (lbs) | Repair Kit |
|---------------|-----------------|-------------|---------------------|--------------|------------|
| J5454F | 1/2 | Full Polish | 15 | 1.65 | J5452FRK |

FLEX-HEAD RATCHETS

- › 180° flex.
- › 72-tooth gear.
- › 5° ratcheting angle.
- › Small head design and tight swing to allow access to fastener in a tight area.
- › Full polish shaft with knurled grip allows for a strong slip-resistant grip.



| Product # | Drive Size (in) | Finish | Overall Length (in) | Weight (lbs) | Repair Kit |
|---------------|-----------------|-------------|---------------------|--------------|------------|
| J4757F | 1/4 | Full Polish | 6-37/64 | 0.32 | J4752FRK |
| J5257F | 3/8 | Full Polish | 8-1/2 | 0.86 | J5252FRK |
| J5457F | 1/2 | Full Polish | 17-3/32 | 1.53 | J5452FRK |

ASME B107.500

FACOM® INSULATED RATCHETS



- › Sockets and accessories secured by spring-ball.
- › 2 color warning handle insulation - color changes from orange to yellow if insulation integrity compromised.
- › For manual use.
- › Insulated to 1000V AC or 1500 DC.



| Product # | Drive Size (in) | Overall Length (in) | Weight (lbs) |
|---------------------|-----------------|---------------------|--------------|
| FT-R.151AVSE | 1/4 | 4-7/8 | 0.28 |
| FT-J.151AVSE | 3/8 | 7 | 0.53 |
| FT-S.151AVSE | 1/2 | 10-3/8 | 1.24 |

SPUD HANDLE RATCHET

- › Tapered handle for aligning bolt holes.
- › Spring-loaded pellet in male drive plug.
- › Black oxide finish.



| Product # | Drive Size (in) | Finish | Overall Length (in) | Weight (lbs) |
|-------------------|-----------------|-------------|---------------------|--------------|
| J5449-14BL | 1/2 | Black Oxide | 14 | 2.03 |

 ASME B107.500

SCAFFOLDING RATCHET

- › The scaffold ratchet is designed for working with scaffolding and other construction applications.
- › Socket retained with through hole and pin for safety.
- › Hammer tip reduces vibration and protects fasteners against distortion.
- › Hole in ratchet handle to be used with tether strap.



| Product # | Drive Size (in) | Finish | Overall Length (in) | Weight (lbs) |
|----------------|-----------------|-------------|---------------------|--------------|
| J5449SC | 1/2 | Full Polish | 10 | 2.01 |







SPINNER RATCHETS

- › Made from alloy steel.
- › Heat-treated for strength and durability.
- › Fits on the drive end of the ratchet for quickly running down the fastener before final tightening with the ratchet.

| Product # | Drive Size (in) | Finish | Overall Length (in) | Weight (lbs) |
|--------------|-----------------|-------------|---------------------|--------------|
| J5251 | 3/8 | Full Polish | 1-1/2 | 0.56 |

ASME B107.500



SOCKET DRIVERS

| Product # | Drive Size (in) | Finish | Overall Length (in) | Weight (lbs) |
|--------------|-----------------|-------------|---------------------|--------------|
| J4769 | 1/4 | Full Polish | 6 | 0.22 |

ASME B107.500

- › 1/4" square female drive in handle.

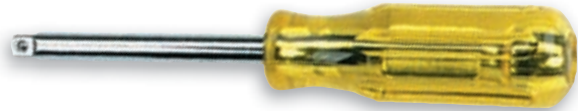

FLEXIBLE DRIVERS

| Product # | Drive Size (in) | Finish | Overall Length (in) | Weight (lbs) |
|--------------|-----------------|--------|---------------------|--------------|
| J4764 | 1/4 | Chrome | 6-3/4 | 0.19 |
| J5267 | 3/8 | Chrome | 9 | 0.35 |

ASME B107.500

- › Flexible shaft for bending around obstructions in low torque applications.



RATCHET ADAPTERS

- › Converts standard handles to ratcheting handles.

| Product # | Drive Size (in) | Finish | Overall Length (in) | Weight (lbs) |
|--------------|-----------------|-------------|---------------------|--------------|
| J5247 | 3/8 | Full Polish | 2-1/16 | 0.34 |
| J5447 | 1/2 | Full Polish | 2-21/32 | 0.86 |
| J5647 | 3/4 | Full Polish | 3-3/4 | 2.38 |

ASME B107.500



PEAR HEAD RATCHET REPAIR KITS

| Product # | Drive Size (in) | Ratchet # | Weight (lbs) |
|--------------------|-----------------|------------|--------------|
| J4749XLRK | 1/4 | J4749XL | 0.04 |
| J4749XLHSRK | 1/4 | J4749XLHS | 0.06 |
| J4749RK | 1/4 | J4749 | 0.04 |
| J4749HSRK | 1/4 | J4749HS | 0.04 |
| J5249XLRK | 3/8 | J5249XL | 0.13 |
| J5249FWRK | 3/8 | J5249FW | 0.13 |
| J5249HSRK | 3/8 | J5249HS | 0.15 |
| J5249XLHSRK | 3/8 | J5249XLHS | 0.15 |
| J5449RK | 1/2 | J5449 | 0.38 |
| J5449UTRK | 1/2 | J5449UT | 0.38 |
| J5449XLRK | 1/2 | J5449XL | 0.23 |
| J5449-14RK | 1/2 | J5449-14BL | 0.37 |
| J5450FWRK | 1/2 | J5450FW | 0.26 |
| J5649FWRK | 3/4 | J5649FW | 1.00 |
| J5649RK | 3/4 | J5649 | 1.00 |

ASME B107.500



ROUND HEAD RATCHET REPAIR KITS

| Product # | Drive Size (in) | Ratchet # | Weight (lbs) |
|-----------------|-----------------|----------------------------------|--------------|
| J4752FRK | 1/4 | J4752F, J4752FBL | 0.10 |
| J5252FRK | 3/8 | J5252F, J5252FBL, J5257F | 0.60 |
| J5452FRK | 1/2 | J5452F, J5452FBL, J5454F, J5457F | 0.30 |



REVERSE CAM REPAIR KITS

| Product # | Drive Size (in) | Weight (lbs) |
|----------------|-----------------|--------------|
| J5649RC | 3/4 | 0.02 |



HINGE HANDLES

| Product # | Drive Size (in) | Finish | Overall Length (in) | Weight (lbs) |
|----------------|-----------------|-------------|---------------------|--------------|
| J4766 | 1/4 | Full Polish | 5-3/4 | 0.22 |
| J5265 | 3/8 | Full Polish | 8-1/2 | 0.58 |
| J5265BL | 3/8 | Black Oxide | 8-1/2 | 0.58 |
| J5266 | 3/8 | Full Polish | 12 | 0.80 |
| J5466 | 1/2 | Full Polish | 10-7/8 | 1.14 |
| J5467 | 1/2 | Full Polish | 15-3/4 | 1.52 |
| J5468 | 1/2 | Full Polish | 18-5/8 | 1.69 |
| J5468BL | 1/2 | Black Oxide | 18-5/8 | 1.69 |
| J5469 | 1/2 | Full Polish | 24 | 2.68 |
| J5668 | 3/4 | Full Polish | 20 | 4.32 |
| J5668BL | 3/4 | Black Oxide | 20 | 4.41 |
| J5868 | 1 | Full Polish | 27 | 7.56 |

ASME B107.500



SPEED HANDLES

- › Made from alloy steel.
- › Heat-treated for strength and durability.

| Product # | Drive Size (in) | Finish | Overall Length (in) | Weight (lbs) |
|---------------|-----------------|-------------|---------------------|--------------|
| J4780G | 1/4 | Full Polish | 15-1/2 | 0.52 |
| J5280G | 3/8 | Full Polish | 17-1/2 | 0.86 |
| J5480 | 1/2 | Full Polish | 18 | 1.51 |

ASME B107.500



SLIDING T-HANDLES

| Product # | Drive Size (in) | Finish | Overall Length (in) | Weight (lbs) |
|--------------|-----------------|-------------|---------------------|--------------|
| J4785 | 1/4 | Full Polish | 4-1/2 | 0.08 |
| J5285 | 3/8 | Full Polish | 8 | 0.41 |
| J5485 | 1/2 | Full Polish | 12-15/16 | 1.11 |
| J5685 | 3/4 | Full Polish | 20 | 2.95 |
| J5884 | 1 | Full Polish | 28-1/2 | 6.30 |

ASME B107.500

- › Made from alloy steel.
- › Heat-treated for strength and durability.



ELL HANDLE

- › Satin finish.

| Product # | Drive Size (in) | Finish | Overall Length (in) | Weight (lbs) |
|--------------|-----------------|--------|---------------------|--------------|
| J5686 | 3/4 | Satin | 16 | 3.96 |



STANDARD EXTENSIONS

| Product # | Drive Size (in) | Finish | Overall Length (in) | Weight (lbs) |
|------------------|-----------------|-------------|---------------------|--------------|
| J4759 | 1/4 | Full Polish | 2 | 0.05 |
| J4760 | 1/4 | Full Polish | 3 | 0.08 |
| J4761 | 1/4 | Full Polish | 6 | 0.15 |
| J4762 | 1/4 | Full Polish | 10 | 0.24 |
| J4763 | 1/4 | Full Polish | 14-1/8 | 0.30 |
| J5259 | 3/8 | Full Polish | 1-3/4 | 0.11 |
| J5259B | 3/8 | Black Oxide | 1-3/4 | 0.11 |
| J5260 | 3/8 | Full Polish | 3 | 0.16 |
| J5260B | 3/8 | Black Oxide | 3 | 0.16 |
| J5260-06 | 3/8 | Full Polish | 6 | 0.31 |
| J5260-06B | 3/8 | Black Oxide | 6 | 0.30 |
| J5261 | 3/8 | Full Polish | 8 | 0.40 |
| J5261B | 3/8 | Black Oxide | 8 | 0.46 |
| J5262 | 3/8 | Full Polish | 12 | 0.61 |
| J5262B | 3/8 | Black Oxide | 12 | 0.62 |
| J5263 | 3/8 | Full Polish | 17-3/16 | 0.94 |
| J5460 | 1/2 | Full Polish | 2-1/2 | 0.24 |
| J5460B | 1/2 | Black Oxide | 2-1/2 | 0.24 |
| J5461 | 1/2 | Full Polish | 5 | 0.44 |
| J5461B | 1/2 | Black Oxide | 5 | 0.44 |
| J5463 | 1/2 | Full Polish | 10 | 0.89 |
| J5463B | 1/2 | Black Oxide | 10 | 0.89 |
| J5464 | 1/2 | Full Polish | 20 | 1.87 |
| J5465 | 1/2 | Full Polish | 36 | 3.41 |
| J5660 | 3/4 | Full Polish | 4 | 0.88 |
| J5661 | 3/4 | Full Polish | 8 | 1.80 |
| J5663 | 3/4 | Full Polish | 16 | 2.36 |
| J5861 | 1 | Full Polish | 8 | 2.88 |
| J5863 | 1 | Full Polish | 17 | 4.87 |



ASME B107.500

- › Extensions help provide access to fasteners in areas that might otherwise be difficult to reach.



LOCKING EXTENSIONS

| Product # | Drive Size (in) | Finish | Overall Length (in) | Weight (lbs) |
|------------------|-----------------|-------------|---------------------|--------------|
| J4759L | 1/4 | Full Polish | 2 | 0.07 |
| J4761L | 1/4 | Full Polish | 6 | 0.15 |
| J5260-03L | 3/8 | Full Polish | 3 | 0.21 |
| J5260-06L | 3/8 | Full Polish | 6 | 0.37 |
| J5262L | 3/8 | Full Polish | 12 | 0.71 |
| J5460-03L | 1/2 | Full Polish | 3 | 0.40 |
| J5461L | 1/2 | Full Polish | 5 | 0.55 |
| J5463L | 1/2 | Full Polish | 10 | 1.04 |



ASME B107.500

- › One-piece extension design.
- › Provides positive socket retention.
- › Use where accidental socket disengagement may be a concern or safety hazard.



WOBBLE EXTENSIONS

| Product # | Drive Size (in) | Finish | Overall Length (in) | Weight (lbs) |
|-----------|-----------------|-------------|---------------------|--------------|
| J4759W | 1/4 | Full Polish | 2 | 0.06 |
| J4761W | 1/4 | Full Polish | 6 | 0.14 |
| J5259W | 3/8 | Full Polish | 1-3/4 | 0.11 |
| J5260W | 3/8 | Full Polish | 3 | 0.17 |
| J5260-06W | 3/8 | Full Polish | 6 | 0.29 |
| J5261W | 3/8 | Full Polish | 8 | 0.42 |
| J5262W | 3/8 | Full Polish | 12 | 0.65 |
| J5263W | 3/8 | Full Polish | 17-3/16 | 0.92 |
| J5460W | 1/2 | Full Polish | 2-1/2 | 0.24 |
| J5461W | 1/2 | Full Polish | 5 | 0.44 |
| J5463W | 1/2 | Full Polish | 10 | 0.89 |
| J5464W | 1/2 | Full Polish | 20 | 1.90 |

 ASME B107.500

- › Provides up to 17° angle of operation.
- › Socket can be pushed past the detent ball for straight driving.



FLEXIBLE EXTENSIONS

- › Flexible shaft extensions help reach around obstructions in low torque applications.

| Product # | Drive Size (in) | Finish | Overall Length (in) | Weight (lbs) |
|-----------|-----------------|-------------|---------------------|--------------|
| J4765 | 1/4 | Full Polish | 6-1/4 | 0.11 |
| J5268 | 3/8 | Black Oxide | 8 | 0.25 |

 ASME B107.500



DRIVE ADAPTERS

| Product # | Size (in) | Finish | Overall Length (in) | Weight (lbs) |
|-----------|-----------------|-------------|---------------------|--------------|
| J5255 | 3/8" F x 1/4" M | Full Polish | 1 | 0.05 |
| J5256 | 1/4" F x 3/8" M | Full Polish | 1 | 0.04 |
| J5253 | 3/8" F x 1/2" M | Full Polish | 1-7/16 | 0.11 |
| J5254 | 1/2" F x 3/8" M | Full Polish | 1-3/8 | 0.13 |
| J5653 | 1/2" F x 3/4" M | Full Polish | 1-11/16 | 0.24 |
| J5453 | 3/4" F x 1/2" M | Full Polish | 1-7/8 | 0.39 |
| J5853 | 3/4" F x 1" M | Full Polish | 2-1/2 | 0.82 |
| J5854 | 1" F x 3/4" M | Full Polish | 2-7/8 | 1.27 |

 ASME B107.500



LOCKING ADAPTERS

- › Includes hex key for easy locking into drive tool.
- › Knurl locking ring.

| Product # | Drive Size (in) | Finish | Overall Length (in) | Weight (lbs) |
|-------------|-----------------|-------------|---------------------|--------------|
| J4759BLS | 1/4 | Black Oxide | 1-11/16 | 0.06 |
| J5260-02BLS | 3/8 | Black Oxide | 2-1/8 | 0.12 |
| J5460-02BLS | 1/2 | Black Oxide | 3 | 0.36 |





UNIVERSAL JOINTS

| Product # | Drive Size (in) | Finish | Overall Length (in) | Weight (lbs) |
|-----------|-----------------|-------------|---------------------|--------------|
| J4770A | 1/4 | Full Polish | 1-11/32 | 0.04 |
| J5270A | 3/8 | Full Polish | 1-7/8 | 0.13 |
| J5470A | 1/2 | Full Polish | 2-3/4 | 0.30 |
| J5670 | 3/4 | Full Polish | 4 | 1.03 |





1/4" DRIVE 37 PIECE COMBINATION SOCKET SET - 6 POINT

Product #: **J47120**

- ▶ 6 Point Standard: 3/16, 7/32, 1/4, 9/32, 5/16, 11/32, 3/8, 7/16, 1/2, 9/16 Inch.
- ▶ 8 Point Standard: 1/4, 5/16, 3/8 Inch.
- ▶ 6 Point Deep: 3/16, 7/32, 1/4, 9/32, 5/16, 11/32, 3/8, 7/16, 1/2, 9/16 Inch.
- ▶ Accessories: Phillips® Bits #1 and #2, Standard Bits 3/8, 3/16, 1/4 Inch, Pear Head Ratchet, 2, 3, and 6 Inch Extensions, 6 Inch Flex Extension, Hinge Handle, Socket Driver, Universal Joint, Sliding T-Handle, and Blow-Molded Case.
- ▶ Weight (lbs): 5.79



| Contents | Description | ASME Spec. | AS Spec. |
|----------|---|---------------|----------|
| J4706 | Socket, 1/4" DR 3/16" 6 PT | ASME B107.1 | |
| J4707 | Socket, 1/4" DR 7/32" 6 PT | ASME B107.1 | |
| J4708 | Socket, 1/4" DR 1/4" 6 PT | ASME B107.1 | |
| J4709 | Socket, 1/4" DR 9/32" 6 PT | ASME B107.1 | |
| J4710 | Socket, 1/4" DR 5/16" 6 PT | ASME B107.1 | |
| J4711 | Socket, 1/4" DR 11/32" 6 PT | ASME B107.1 | |
| J4712 | Socket, 1/4" DR 3/8" 6 PT | ASME B107.1 | |
| J4714 | Socket, 1/4" DR 7/16" 6 PT | ASME B107.1 | |
| J4716 | Socket, 1/4" DR 1/2" 6 PT | ASME B107.1 | |
| J4718 | Socket, 1/4" DR 9/16" 6 PT | ASME B107.1 | |
| J4706L | Socket, 1/4" DR 3/16" 6 PT Deep | ASME B107.1 | |
| J4707L | Socket, 1/4" DR 7/32" 6 PT Deep | ASME B107.1 | |
| J4708L | Socket, 1/4" DR 1/4" 6 PT Deep | ASME B107.1 | |
| J4709L | Socket, 1/4" DR 9/32" 6 PT Deep | ASME B107.1 | |
| J4710L | Socket, 1/4" DR 5/16" 6 PT Deep | ASME B107.1 | |
| J4711L | Socket, 1/4" DR 11/32" 6 PT Deep | ASME B107.1 | |
| J4712L | Socket, 1/4" DR 3/8" 6 PT Deep | ASME B107.1 | |
| J4714L | Socket, 1/4" DR 7/16" 6 PT Deep | ASME B107.1 | |
| J4716L | Socket, 1/4" DR 1/2" 6 PT Deep | ASME B107.1 | |
| J4718L | Socket, 1/4" DR 9/16" 6 PT Deep | ASME B107.1 | |
| J4708S | Socket, 1/4" DR 1/4" 8 PT | ASME B107.1 | |
| J4710S | Socket, 1/4" DR 5/16" 8 PT | ASME B107.1 | |
| J4712S | Socket, 1/4" DR 3/8" 8 PT | ASME B107.1 | |
| J4737 | Socket, Bit 1/4" DR #1 Phillips® | | |
| J4738 | Socket, Bit 1/4" DR #2 Phillips® | | |
| J4743 | Socket, Bit 1/4" DR Slotted 1/4" | | |
| J4744 | Socket, Bit 1/4" DR Slotted 3/16" | | |
| J4745 | Socket, Bit 1/4" DR Slotted 1/4" | | |
| J4749 | Ratchet, 1/4" DR Standard Length Classic Pear Head 5" | ASME B107.500 | |
| J4759 | Extension, 1/4" DR 2" | ASME B107.500 | AS 4283 |
| J4760 | Extension, 1/4" DR 3" | ASME B107.500 | |
| J4761 | Extension, 1/4" DR 6" | ASME B107.500 | AS 4283 |
| J4765 | Extension, Flex 1/4" DR 6-1/4" | ASME B107.500 | |
| J4766 | Handle, Hinge 1/4" DR 5-3/4" | ASME B107.500 | AS 4283 |
| J4769 | Driver, Socket 1/4" DR | ASME B107.500 | |
| J4770A | Universal Joint, 1/4" DR 1-11/32" | ASME B107.500 | |
| J4785 | Handle, Sliding T 1/4" DR 4-1/2" | ASME B107.500 | |
| JBM1008 | Blow-Molded Case | | |



1/4" DRIVE 37 PIECE COMBINATION SOCKET SET - 6 POINT

Product #: J47120XL

- ▶ 6 Point Standard: 3/16, 7/32, 1/4, 9/32, 5/16, 11/32, 3/8, 7/16, 1/2, 9/16 Inch.
- ▶ 6 Point Deep: 3/16, 7/32, 1/4, 9/32, 5/16, 11/32, 3/8, 7/16, 1/2, 9/16 Inch.
- ▶ 8 Point Standard: 1/4, 5/16, 3/8 Inch.
- ▶ Accessories: Premium Ratchet, Socket Driver, 2, 3, and 6 Inch Extensions, 6 Inch Flex Driver, Hinge Handle, Sliding T-Handle, Universal Joint, and Blow-Molded Case.
- ▶ Weight (lbs): 5.75



| Contents | Description | ASME Spec. | AS Spec. |
|----------|---|---------------|----------|
| J4706 | Socket, 1/4" DR 3/16" 6 PT | ASME B107.1 | |
| J4706L | Socket, 1/4" DR 3/16" 6 PT Deep | ASME B107.1 | |
| J4707 | Socket, 1/4" DR 7/32" 6 PT | ASME B107.1 | |
| J4707L | Socket, 1/4" DR 7/32" 6 PT Deep | ASME B107.1 | |
| J4708 | Socket, 1/4" DR 1/4" 6 PT | ASME B107.1 | |
| J4708L | Socket, 1/4" DR 1/4" 6 PT Deep | ASME B107.1 | |
| J4708S | Socket, 1/4" DR 1/4" 8 PT | ASME B107.1 | |
| J4709 | Socket, 1/4" DR 9/32" 6 PT | ASME B107.1 | |
| J4709L | Socket, 1/4" DR 9/32" 6 PT Deep | ASME B107.1 | |
| J4710 | Socket, 1/4" DR 5/16" 6 PT | ASME B107.1 | |
| J4710L | Socket, 1/4" DR 5/16" 6 PT Deep | ASME B107.1 | |
| J4710S | Socket, 1/4" DR 5/16" 8 PT | ASME B107.1 | |
| J4711 | Socket, 1/4" DR 11/32" 6 PT | ASME B107.1 | |
| J4711L | Socket, 1/4" DR 11/32" 6 PT Deep | ASME B107.1 | |
| J4712 | Socket, 1/4" DR 3/8" 6 PT | ASME B107.1 | |
| J4712L | Socket, 1/4" DR 3/8" 6 PT Deep | ASME B107.1 | |
| J4712S | Socket, 1/4" DR 3/8" 8 PT | ASME B107.1 | |
| J4714 | Socket, 1/4" DR 7/16" 6 PT | ASME B107.1 | |
| J4714L | Socket, 1/4" DR 7/16" 6 PT Deep | ASME B107.1 | |
| J4716 | Socket, 1/4" DR 1/2" 6 PT | ASME B107.1 | |
| J4716L | Socket, 1/4" DR 1/2" 6 PT Deep | ASME B107.1 | |
| J4718 | Socket, 1/4" DR 9/16" 6 PT | ASME B107.1 | |
| J4718L | Socket, 1/4" DR 9/16" 6 PT Deep | ASME B107.1 | |
| J4737 | Socket, Bit 1/4" DR #1 Phillips® | | |
| J4738 | Socket, Bit 1/4" DR #2 Phillips® | | |
| J4743 | Socket, Bit 1/4" DR Slotted 1/4" | | |
| J4744 | Socket, Bit 1/4" DR Slotted 3/16" | | |
| J4745 | Socket, Bit 1/4" DR Slotted | | |
| J4749XL | Ratchet, 1/4" DR Standard Length Premium Pear Head 5-45/64" | ASME B107.500 | |
| J4759 | Extension, 1/4" DR 2" | ASME B107.500 | AS 4283 |
| J4760 | Extension, 1/4" DR 3" | ASME B107.500 | |
| J4761 | Extension, 1/4" DR 6" | ASME B107.500 | AS 4283 |
| J4765 | Extension, Flex 1/4" DR 6-1/4" | ASME B107.500 | |
| J4766 | Handle, Hinge 1/4" DR 5-3/4" | ASME B107.500 | AS 4283 |
| J4769 | Driver, Socket 1/4" DR | ASME B107.500 | |
| J4770A | Universal Joint, 1/4" DR 1-11/32" | | |
| J4785 | Handle, Sliding T 1/4" DR 4-1/2" | ASME B107.500 | |
| JBM1008 | Blow-Molded Case | | |



1/4" DRIVE 29 PIECE METRIC COMBINATION SOCKET SET - 6 POINT

METRIC

Product #: J47206

- ▶ 6 Point Standard: 4, 5, 5.5, 6, 7, 8, 9, 10, 11, 12, 13, 14 mm.
- ▶ 6 Point Deep: 4, 5, 5.5, 6, 7, 8, 9, 10, 11, 12, 13, 14 mm.
- ▶ Accessories: Pear Head Ratchet, Socket Driver, 2 and 6 Inch Extensions, Universal Joint, and Blow-Molded Case.
- ▶ Weight (lbs): 4.21



| Contents | Description | ASME Spec. | AS Spec. |
|----------|---|---------------|----------|
| J4704M | Socket, 1/4" DR 4 mm 6 PT | ASME B107.5M | |
| J4705M | Socket, 1/4" DR 5 mm 6 PT | ASME B107.5M | |
| J47055M | Socket, 1/4" DR 5.5 mm 6 PT | ASME B107.5M | |
| J4706M | Socket, 1/4" DR 6 mm 6 PT | ASME B107.5M | |
| J4707M | Socket, 1/4" DR 7 mm 6 PT | ASME B107.5M | |
| J4708M | Socket, 1/4" DR 8 mm 6 PT | ASME B107.5M | |
| J4709M | Socket, 1/4" DR 9 mm 6 PT | ASME B107.5M | |
| J4710M | Socket, 1/4" DR 10 mm 6 PT | ASME B107.5M | |
| J4711M | Socket, 1/4" DR 11 mm 6 PT | ASME B107.5M | |
| J4712M | Socket, 1/4" DR 12 mm 6 PT | ASME B107.5M | |
| J4713M | Socket, 1/4" DR 13 mm 6 PT | ASME B107.5M | |
| J4714M | Socket, 1/4" DR 14 mm 6 PT | ASME B107.5M | |
| J4704LM | Socket, 1/4" DR 4 mm 6 PT Deep | ASME B107.5M | |
| J4705LM | Socket, 1/4" DR 5 mm 6 PT Deep | ASME B107.5M | |
| J47055LM | Socket, 1/4" DR 5.5 mm 6 PT Deep | ASME B107.5M | |
| J4706LM | Socket, 1/4" DR 6 mm 6 PT Deep | ASME B107.5M | |
| J4707LM | Socket, 1/4" DR 7 mm 6 PT Deep | ASME B107.5M | |
| J4708LM | Socket, 1/4" DR 8 mm 6 PT Deep | ASME B107.5M | |
| J4709LM | Socket, 1/4" DR 9 mm 6 PT Deep | ASME B107.5M | |
| J4710LM | Socket, 1/4" DR 10 mm 6 PT Deep | ASME B107.5M | |
| J4711LM | Socket, 1/4" DR 11 mm 6 PT Deep | ASME B107.5M | |
| J4712LM | Socket, 1/4" DR 12 mm 6 PT Deep | ASME B107.5M | |
| J4713LM | Socket, 1/4" DR 13 mm 6 PT Deep | ASME B107.5M | |
| J4714LM | Socket, 1/4" DR 14 mm 6 PT Deep | ASME B107.5M | |
| J4749 | Ratchet, 1/4" DR Standard Length Classic Pear Head 5" | ASME B107.500 | |
| J4759 | Extension, 1/4" DR 2" | ASME B107.500 | AS 4283 |
| J4761 | Extension, 1/4" DR 6" | ASME B107.500 | AS 4283 |
| J4769 | Driver, Socket 1/4" DR | ASME B107.500 | |
| J4770A | Universal Joint, 1/4" DR 1-11/32" | ASME B107.500 | |
| JBM1004 | Blow-Molded Case | | |





1/4" DRIVE 29 PIECE METRIC COMBINATION SOCKET SET - 6 POINT



Product #: J47206XL

- ▶ 6 Point Standard: 4, 5, 5.5, 6, 7, 8, 9, 10, 11, 12, 13, 14 mm.
- ▶ 6 Point Deep: 4, 5, 5.5, 6, 7, 8, 9, 10, 11, 12, 13, 14 mm.
- ▶ Accessories: Premium Ratchet, Socket Driver, 2 and 6 Inch Extensions, Universal Joint, and Blow-Molded Case.
- ▶ Weight (lbs): 4.27



| Contents | Description | ASME Spec. | AS Spec. |
|----------|---|---------------|----------|
| J4704LM | Socket, 1/4" DR 4 mm 6 PT Deep | ASME B107.5M | |
| J4704M | Socket, 1/4" DR 4 mm 6 PT | ASME B107.5M | |
| J47055LM | Socket, 1/4" DR 5.5 mm 6 PT Deep | ASME B107.5M | |
| J47055M | Socket, 1/4" DR 5.5 mm 6 PT | ASME B107.5M | |
| J4705LM | Socket, 1/4" DR 5 mm 6 PT Deep | ASME B107.5M | |
| J4705M | Socket, 1/4" DR 5 mm 6 PT | ASME B107.5M | |
| J4706LM | Socket, 1/4" DR 6 mm 6 PT Deep | ASME B107.5M | |
| J4706M | Socket, 1/4" DR 6 mm 6 PT | ASME B107.5M | |
| J4707LM | Socket, 1/4" DR 7 mm 6 PT Deep | ASME B107.5M | |
| J4707M | Socket, 1/4" DR 7 mm 6 PT | ASME B107.5M | |
| J4708LM | Socket, 1/4" DR 8 mm 6 PT Deep | ASME B107.5M | |
| J4708M | Socket, 1/4" DR 8 mm 6 PT | ASME B107.5M | |
| J4709LM | Socket, 1/4" DR 9 mm 6 PT Deep | ASME B107.5M | |
| J4709M | Socket, 1/4" DR 9 mm 6 PT | ASME B107.5M | |
| J4710LM | Socket, 1/4" DR 10 mm 6 PT Deep | ASME B107.5M | |
| J4710M | Socket, 1/4" DR 10 mm 6 PT | ASME B107.5M | |
| J4711LM | Socket, 1/4" DR 11 mm 6 PT Deep | ASME B107.5M | |
| J4711M | Socket, 1/4" DR 11 mm 6 PT | ASME B107.5M | |
| J4712LM | Socket, 1/4" DR 12 mm 6 PT Deep | ASME B107.5M | |
| J4712M | Socket, 1/4" DR 12 mm 6 PT | ASME B107.5M | |
| J4713LM | Socket, 1/4" DR 13 mm 6 PT Deep | ASME B107.5M | |
| J4713M | Socket, 1/4" DR 13 mm 6 PT | ASME B107.5M | |
| J4714LM | Socket, 1/4" DR 14 mm 6 PT Deep | ASME B107.5M | |
| J4714M | Socket, 1/4" DR 14 mm 6 PT | ASME B107.5M | |
| J4749XL | Ratchet, 1/4" DR Standard Length Premium Pear Head 5-45/64" | ASME B107.500 | |
| J4759 | Extension, 1/4" DR 2" | ASME B107.500 | AS 4283 |
| J4761 | Extension, 1/4" DR 6" | ASME B107.500 | AS 4283 |
| J4769 | Driver, Socket 1/4" DR | ASME B107.500 | |
| J4770A | Universal Joint, 1/4" DR 1-11/32" | | |
| JBM1004 | Blow-Molded Case | | |



1/4" DRIVE 25 PIECE COMBINATION SOCKET SET - 6 POINT

Product #: J47116

- › 6 Point Standard: 3/16, 7/32, 1/4, 9/32, 5/16, 11/32, 3/8, 7/16, 1/2, 9/16 Inch.
- › 6 Point Deep: 3/16, 7/32, 1/4, 9/32, 5/16, 11/32, 3/8, 7/16, 1/2, 9/16 Inch.
- › Accessories: Pear Head Ratchet, 2 and 6 Inch Extensions, Socket Driver, Universal Joint, and Blow-Molded Case.
- › Weight (lbs): 4.08



| Contents | Description | ASME Spec. | AS Spec. |
|----------|---|---------------|----------|
| J4706 | Socket, 1/4" DR 3/16" 6 PT | ASME B107.1 | |
| J4707 | Socket, 1/4" DR 7/32" 6 PT | ASME B107.1 | |
| J4708 | Socket, 1/4" DR 1/4" 6 PT | ASME B107.1 | |
| J4709 | Socket, 1/4" DR 9/32" 6 PT | ASME B107.1 | |
| J4710 | Socket, 1/4" DR 5/16" 6 PT | ASME B107.1 | |
| J4711 | Socket, 1/4" DR 11/32" 6 PT | ASME B107.1 | |
| J4712 | Socket, 1/4" DR 3/8" 6 PT | ASME B107.1 | |
| J4714 | Socket, 1/4" DR 7/16" 6 PT | ASME B107.1 | |
| J4716 | Socket, 1/4" DR 1/2" 6 PT | ASME B107.1 | |
| J4718 | Socket, 1/4" DR 9/16" 6 PT | ASME B107.1 | |
| J4706L | Socket, 1/4" DR 3/16" 6 PT Deep | ASME B107.1 | |
| J4707L | Socket, 1/4" DR 7/32" 6 PT Deep | ASME B107.1 | |
| J4708L | Socket, 1/4" DR 1/4" 6 PT Deep | ASME B107.1 | |
| J4709L | Socket, 1/4" DR 9/32" 6 PT Deep | ASME B107.1 | |
| J4710L | Socket, 1/4" DR 5/16" 6 PT Deep | ASME B107.1 | |
| J4711L | Socket, 1/4" DR 11/32" 6 PT Deep | ASME B107.1 | |
| J4712L | Socket, 1/4" DR 3/8" 6 PT Deep | ASME B107.1 | |
| J4714L | Socket, 1/4" DR 7/16" 6 PT Deep | ASME B107.1 | |
| J4716L | Socket, 1/4" DR 1/2" 6 PT Deep | ASME B107.1 | |
| J4718L | Socket, 1/4" DR 9/16" 6 PT Deep | ASME B107.1 | |
| J4749 | Ratchet, 1/4" DR Standard Length Classic Pear Head 5" | ASME B107.500 | |
| J4759 | Extension, 1/4" DR 2" | ASME B107.500 | AS 4283 |
| J4761 | Extension, 1/4" DR 6" | ASME B107.500 | AS 4283 |
| J4769 | Driver, Socket 1/4" DR | ASME B107.500 | |
| J4770A | Universal Joint, 1/4" DR 1-11/32" | ASME B107.500 | |
| JBM1002 | Blow-Molded Case | | |

1/4" DRIVE 25 PIECE COMBINATION SOCKET SET - 6 POINT

Product #: **J47116XL**

- ▶ 6 Point Standard: 3/16, 7/32, 1/4, 9/32, 5/16, 11/32, 3/8, 7/16, 1/2, 9/16 Inch.
- ▶ 6 Point Deep: 3/16, 7/32, 1/4, 9/32, 5/16, 11/32, 3/8, 7/16, 1/2, 9/16 Inch.
- ▶ Accessories: Premium Ratchet, Socket Driver, 2 and 6 Inch Extensions, Universal Joint, and Blow-Molded Case.
- ▶ Weight (lbs): 3.98



| Contents | Description | ASME Spec. | AS Spec. |
|----------|---|---------------|----------|
| J4706 | Socket, 1/4" DR 3/16" 6 PT | ASME B107.1 | |
| J4707 | Socket, 1/4" DR 7/32" 6 PT | ASME B107.1 | |
| J4708 | Socket, 1/4" DR 1/4" 6 PT | ASME B107.1 | |
| J4709 | Socket, 1/4" DR 9/32" 6 PT | ASME B107.1 | |
| J4710 | Socket, 1/4" DR 5/16" 6 PT | ASME B107.1 | |
| J4711 | Socket, 1/4" DR 11/32" 6 PT | ASME B107.1 | |
| J4712 | Socket, 1/4" DR 3/8" 6 PT | ASME B107.1 | |
| J4714 | Socket, 1/4" DR 7/16" 6 PT | ASME B107.1 | |
| J4716 | Socket, 1/4" DR 1/2" 6 PT | ASME B107.1 | |
| J4718 | Socket, 1/4" DR 9/16" 6 PT | ASME B107.1 | |
| J4706L | Socket, 1/4" DR 3/16" 6 PT Deep | ASME B107.1 | |
| J4707L | Socket, 1/4" DR 7/32" 6 PT Deep | ASME B107.1 | |
| J4708L | Socket, 1/4" DR 1/4" 6 PT Deep | ASME B107.1 | |
| J4709L | Socket, 1/4" DR 9/32" 6 PT Deep | ASME B107.1 | |
| J4710L | Socket, 1/4" DR 5/16" 6 PT Deep | ASME B107.1 | |
| J4711L | Socket, 1/4" DR 11/32" 6 PT Deep | ASME B107.1 | |
| J4712L | Socket, 1/4" DR 3/8" 6 PT Deep | ASME B107.1 | |
| J4714L | Socket, 1/4" DR 7/16" 6 PT Deep | ASME B107.1 | |
| J4716L | Socket, 1/4" DR 1/2" 6 PT Deep | ASME B107.1 | |
| J4718L | Socket, 1/4" DR 9/16" 6 PT Deep | ASME B107.1 | |
| J4749XL | Ratchet, 1/4" DR Standard Length Premium Pear Head 5-45/64" | ASME B107.500 | |
| J4759 | Extension, 1/4" DR 2" | ASME B107.500 | AS 4283 |
| J4761 | Extension, 1/4" DR 6" | ASME B107.500 | AS 4283 |
| J4769 | Driver, Socket 1/4" DR | ASME B107.500 | |
| J4770A | Universal Joint, 1/4" DR 1-11/32" | | |
| JBM1002 | Blow-Molded Case | | |



1/4" DRIVE 25 PIECE COMBINATION SOCKET SET - 12 POINT

Product #: J47118

- ▶ 12 Point Standard: 3/16, 7/32, 1/4, 9/32, 5/16, 11/32, 3/8, 7/16, 1/2, 9/16 Inch.
- ▶ 12 Point Deep: 3/16, 7/32, 1/4, 9/32, 5/16, 11/32, 3/8, 7/16, 1/2, 9/16 Inch.
- ▶ Accessories: Pear Head Ratchet, 2 and 6 Inch Extensions, Socket Driver, Universal Joint, and Blow-Molded Case.
- ▶ Weight (lbs): 4.12



| Contents | Description | ASME Spec. | AS Spec. |
|----------|---|---------------|---------------|
| J4706T | Socket, 1/4" DR 3/16" 12 PT | ASME B107.1 | AS954E S3.8.1 |
| J4707T | Socket, 1/4" DR 7/32" 12 PT | ASME B107.1 | AS954E S3.8.1 |
| J4708T | Socket, 1/4" DR 1/4" 12 PT | ASME B107.1 | AS954E S3.8.1 |
| J4709T | Socket, 1/4" DR 9/32" 12 PT | ASME B107.1 | AS954E S3.8.1 |
| J4710T | Socket, 1/4" DR 5/16" 12 PT | ASME B107.1 | AS954E S3.8.1 |
| J4711T | Socket, 1/4" DR 11/32" 12 PT | ASME B107.1 | AS954E S3.8.1 |
| J4712T | Socket, 1/4" DR 3/8" 12 PT | ASME B107.1 | AS954E S3.8.1 |
| J4714T | Socket, 1/4" DR 7/16" 12 PT | ASME B107.1 | AS954E S3.8.1 |
| J4716T | Socket, 1/4" DR 1/2" 12 PT | ASME B107.1 | AS954E S3.8.1 |
| J4718T | Socket, 1/4" DR 9/16" 12 PT | ASME B107.1 | AS954E S3.8.1 |
| J4706LT | Socket, 1/4" DR 3/16" 12 PT Deep | ASME B107.1 | AS954E S3.8.1 |
| J4707LT | Socket, 1/4" DR 7/32" 12 PT Deep | ASME B107.1 | AS954E S3.8.1 |
| J4708LT | Socket, 1/4" DR 1/4" 12 PT Deep | ASME B107.1 | AS954E S3.8.1 |
| J4709LT | Socket, 1/4" DR 9/32" 12 PT Deep | ASME B107.1 | AS954E S3.8.1 |
| J4710LT | Socket, 1/4" DR 5/16" 12 PT Deep | ASME B107.1 | AS954E S3.8.1 |
| J4711LT | Socket, 1/4" DR 11/32" 12 PT Deep | ASME B107.1 | AS954E S3.8.1 |
| J4712LT | Socket, 1/4" DR 3/8" 12 PT Deep | ASME B107.1 | AS954E S3.8.1 |
| J4714LT | Socket, 1/4" DR 7/16" 12 PT Deep | ASME B107.1 | AS954E S3.8.1 |
| J4716LT | Socket, 1/4" DR 1/2" 12 PT Deep | ASME B107.1 | AS954E S3.8.1 |
| J4718LT | Socket, 1/4" DR 9/16" 12 PT Deep | ASME B107.1 | AS954E S3.8.1 |
| J4749 | Ratchet, 1/4" DR Standard Length Classic Pear Head 5" | ASME B107.500 | |
| J4759 | Extension, 1/4" DR 2" | ASME B107.500 | AS 4283 |
| J4761 | Extension, 1/4" DR 6" | ASME B107.500 | AS 4283 |
| J4769 | Driver, Socket 1/4" DR | ASME B107.500 | |
| J4770A | Universal Joint, 1/4" DR 1-11/32" | ASME B107.500 | |
| JBM1002 | Blow-Molded Case | | |





1/4" DRIVE 25 PIECE COMBINATION SOCKET SET - 12 POINT

Product #: **J47118XL**

- › 12 Point Standard: 3/16, 7/32, 1/4, 9/32, 5/16, 11/32, 3/8, 7/16, 1/2, 9/16 Inch.
- › 12 Point Deep: 3/16, 7/32, 1/4, 9/32, 5/16, 11/32, 3/8, 7/16, 1/2, 9/16 Inch.
- › Accessories: Premium Ratchet, Socket Driver, 2 and 6 Inch Extensions, Universal Joint, and Blow-Molded Case.
- › Weight (lbs): 3.99



| Contents | Description | ASME Spec. | AS Spec. |
|----------|---|---------------|---------------|
| J4706LT | Socket, 1/4" DR 3/16" 12 PT Deep | ASME B107.1 | AS954E S3.8.1 |
| J4706T | Socket, 1/4" DR 3/16" 12 PT | ASME B107.1 | AS954E S3.8.1 |
| J4707LT | Socket, 1/4" DR 7/32" 12 PT Deep | ASME B107.1 | AS954E S3.8.1 |
| J4707T | Socket, 1/4" DR 7/32" 12 PT | ASME B107.1 | AS954E S3.8.1 |
| J4708LT | Socket, 1/4" DR 1/4" 12 PT Deep | ASME B107.1 | AS954E S3.8.1 |
| J4708T | Socket, 1/4" DR 1/4" 12 PT | ASME B107.1 | AS954E S3.8.1 |
| J4709LT | Socket, 1/4" DR 9/32" 12 PT Deep | ASME B107.1 | AS954E S3.8.1 |
| J4709T | Socket, 1/4" DR 9/32" 12 PT | ASME B107.1 | AS954E S3.8.1 |
| J4710LT | Socket, 1/4" DR 5/16" 12 PT Deep | ASME B107.1 | AS954E S3.8.1 |
| J4710T | Socket, 1/4" DR 5/16" 12 PT | ASME B107.1 | AS954E S3.8.1 |
| J4711LT | Socket, 1/4" DR 11/32" 12 PT Deep | ASME B107.1 | AS954E S3.8.1 |
| J4711T | Socket, 1/4" DR 11/32" 12 PT | ASME B107.1 | AS954E S3.8.1 |
| J4712LT | Socket, 1/4" DR 3/8" 12 PT Deep | ASME B107.1 | AS954E S3.8.1 |
| J4712T | Socket, 1/4" DR 3/8" 12 PT | ASME B107.1 | AS954E S3.8.1 |
| J4714LT | Socket, 1/4" DR 7/16" 12 PT Deep | ASME B107.1 | AS954E S3.8.1 |
| J4714T | Socket, 1/4" DR 7/16" 12 PT | ASME B107.1 | AS954E S3.8.1 |
| J4716LT | Socket, 1/4" DR 1/2" 12 PT Deep | ASME B107.1 | AS954E S3.8.1 |
| J4716T | Socket, 1/4" DR 1/2" 12 PT | ASME B107.1 | AS954E S3.8.1 |
| J4718LT | Socket, 1/4" DR 9/16" 12 PT Deep | ASME B107.1 | AS954E S3.8.1 |
| J4718T | Socket, 1/4" DR 9/16" 12 PT | ASME B107.1 | AS954E S3.8.1 |
| J4749XL | Ratchet, 1/4" DR Standard Length Premium Pear Head 5-45/64" | ASME B107.500 | |
| J4759 | Extension, 1/4" DR 2" | ASME B107.500 | AS 4283 |
| J4761 | Extension, 1/4" DR 6" | ASME B107.500 | AS 4283 |
| J4769 | Driver, Socket 1/4" DR | ASME B107.500 | |
| J4770A | Universal Joint, 1/4" DR 1-11/32" | | |
| JBM1002 | Blow-Molded Case | | |



1/4" DRIVE 19 PIECE COMBINATION SOCKET SET - 6 POINT AND 8 POINT

Product #: J47114

- › 6 Point Standard: 3/16, 7/32, 1/4, 9/32, 5/16, 11/32, 3/8, 7/16, 1/2, 9/16 Inch.
- › 8 Point Standard: 1/4, 5/16, 3/8 Inch.
- › Accessories: Pear Head Ratchet, 2 and 6 Inch Extensions, Hinge Handle, Socket Driver, Universal Joint, and Blow-Molded Case.
- › Weight (lbs): 2.76



| Contents | Description | ASME Spec. | AS Spec. |
|----------|---|---------------|----------|
| J4706 | Socket, 1/4" DR 3/16" 6 PT | ASME B107.1 | |
| J4707 | Socket, 1/4" DR 7/32" 6 PT | ASME B107.1 | |
| J4708 | Socket, 1/4" DR 1/4" 6 PT | ASME B107.1 | |
| J4709 | Socket, 1/4" DR 9/32" 6 PT | ASME B107.1 | |
| J4710 | Socket, 1/4" DR 5/16" 6 PT | ASME B107.1 | |
| J4711 | Socket, 1/4" DR 11/32" 6 PT | ASME B107.1 | |
| J4712 | Socket, 1/4" DR 3/8" 6 PT | ASME B107.1 | |
| J4714 | Socket, 1/4" DR 7/16" 6 PT | ASME B107.1 | |
| J4716 | Socket, 1/4" DR 1/2" 6 PT | ASME B107.1 | |
| J4718 | Socket, 1/4" DR 9/16" 6 PT | ASME B107.1 | |
| J4708S | Socket, 1/4" DR 1/4" 8 PT | ASME B107.1 | |
| J4710S | Socket, 1/4" DR 5/16" 8 PT | ASME B107.1 | |
| J4712S | Socket, 1/4" DR 3/8" 8 PT | ASME B107.1 | |
| J4749 | Ratchet, 1/4" DR Standard Length Classic Pear Head 5" | ASME B107.500 | |
| J4759 | Extension, 1/4" DR 2" | ASME B107.500 | AS 4283 |
| J4761 | Extension, 1/4" DR 6" | ASME B107.500 | AS 4283 |
| J4766 | Handle, Hinge 1/4" DR 5-3/4" | ASME B107.500 | AS 4283 |
| J4769 | Driver, Socket 1/4" DR | ASME B107.500 | |
| J4770A | Universal Joint, 1/4" DR 1-11/32" | | |
| JBM1006 | Blow-Molded Case | | |

1/4" DRIVE 19 PIECE COMBINATION SOCKET SET - 6 POINT AND 8 POINT

Product #: J47114XL

- › 6 Point Standard: 3/16, 7/32, 1/4, 9/32, 5/16, 11/32, 3/8, 7/16, 1/2, 9/16 Inch.
- › 8 Point Standard: 1/4, 5/16, 3/8 Inch.
- › Accessories: Premium Ratchet, Socket Driver, 2 and 6 Inch Extensions, Universal Joint, Hinge Handle, and Blow-Molded Case.
- › Weight (lbs): 3.02



| Contents | Description | ASME Spec. | AS Spec. |
|----------|---|---------------|----------|
| J4706 | Socket, 1/4" DR 3/16" 6 PT | ASME B107.1 | |
| J4707 | Socket, 1/4" DR 7/32" 6 PT | ASME B107.1 | |
| J4708 | Socket, 1/4" DR 1/4" 6 PT | ASME B107.1 | |
| J4708S | Socket, 1/4" DR 1/4" 8 PT | ASME B107.1 | |
| J4709 | Socket, 1/4" DR 9/32" 6 PT | ASME B107.1 | |
| J4710 | Socket, 1/4" DR 5/16" 6 PT | ASME B107.1 | |
| J4710S | Socket, 1/4" DR 5/16" 8 PT | ASME B107.1 | |
| J4711 | Socket, 1/4" DR 11/32" 6 PT | ASME B107.1 | |
| J4712 | Socket, 1/4" DR 3/8" 6 PT | ASME B107.1 | |
| J4712S | Socket, 1/4" DR 3/8" 8 PT | ASME B107.1 | |
| J4714 | Socket, 1/4" DR 7/16" 6 PT | ASME B107.1 | |
| J4716 | Socket, 1/4" DR 1/2" 6 PT | ASME B107.1 | |
| J4718 | Socket, 1/4" DR 9/16" 6 PT | ASME B107.1 | |
| J4749XL | Ratchet, 1/4" DR Standard Length Premium Pear Head 5-45/64" | ASME B107.500 | |
| J4759 | Extension, 1/4" DR 2" | ASME B107.500 | AS 4283 |
| J4761 | Extension, 1/4" DR 6" | ASME B107.500 | AS 4283 |
| J4766 | Handle, Hinge 1/4" DR 5-3/4" | ASME B107.500 | AS 4283 |
| J4769 | Driver, Socket 1/4" DR | ASME B107.500 | |
| J4770A | Universal Joint, 1/4" DR 1-11/32" | | |
| JBM1006 | Blow-Molded Case | | |





1/4" DRIVE 17 PIECE METRIC COMBINATION SOCKET SET - 6 POINT

Product #: J47204

- › 6 Point Metric: 4, 5, 5.5, 6, 7, 8, 9, 10, 11, 12, 13, 14 mm.
- › Accessories: Pear Head Ratchet, Socket Driver, 2 and 6 Inch Extensions, Universal Joint, and Blow-Molded Case.
- › Weight (lbs): 2.58



METRIC



| Contents | Description | ASME Spec. | AS Spec. |
|----------|---|---------------|----------|
| J4704M | Socket, 1/4" DR 4 mm 6 PT | ASME B107.5M | |
| J4705M | Socket, 1/4" DR 5 mm 6 PT | ASME B107.5M | |
| J47055M | Socket, 1/4" DR 5.5 mm 6 PT | ASME B107.5M | |
| J4706M | Socket, 1/4" DR 6 mm 6 PT | ASME B107.5M | |
| J4707M | Socket, 1/4" DR 7 mm 6 PT | ASME B107.5M | |
| J4708M | Socket, 1/4" DR 8 mm 6 PT | ASME B107.5M | |
| J4709M | Socket, 1/4" DR 9 mm 6 PT | ASME B107.5M | |
| J4710M | Socket, 1/4" DR 10 mm 6 PT | ASME B107.5M | |
| J4711M | Socket, 1/4" DR 11 mm 6 PT | ASME B107.5M | |
| J4712M | Socket, 1/4" DR 12 mm 6 PT | ASME B107.5M | |
| J4713M | Socket, 1/4" DR 13 mm 6 PT | ASME B107.5M | |
| J4714M | Socket, 1/4" DR 14 mm 6 PT | ASME B107.5M | |
| J4749 | Ratchet, 1/4" DR Standard Length Classic Pear Head 5" | ASME B107.500 | |
| J4759 | Extension, 1/4" DR 2" | ASME B107.500 | AS 4283 |
| J4761 | Extension, 1/4" DR 6" | ASME B107.500 | AS 4283 |
| J4769 | Driver, Socket 1/4" DR | ASME B107.500 | |
| J4770A | Universal Joint, 1/4" DR 1-11/32" | ASME B107.500 | |
| JBM1007 | Blow-Molded Case | | |

1/4" DRIVE 17 PIECE METRIC COMBINATION SOCKET SET - 6 POINT

Product #: J47204XL

- › 6 Point Standard: 4, 5, 5.5, 6, 7, 8, 9, 10, 11, 12, 13, 14 mm.
- › Accessories: Premium Ratchet, Socket Driver, 2 and 6 Inch Extensions, Universal Joint, and Blow-Molded Case.
- › Weight (lbs): 2.72



| Contents | Description | ASME Spec. | AS Spec. |
|----------|---|---------------|----------|
| J4704M | Socket, 1/4" DR 4 mm 6 PT | ASME B107.5M | |
| J47055M | Socket, 1/4" DR 5.5 mm 6 PT | ASME B107.5M | |
| J4705M | Socket, 1/4" DR 5 mm 6 PT | ASME B107.5M | |
| J4706M | Socket, 1/4" DR 6 mm 6 PT | ASME B107.5M | |
| J4707M | Socket, 1/4" DR 7 mm 6 PT | ASME B107.5M | |
| J4708M | Socket, 1/4" DR 8 mm 6 PT | ASME B107.5M | |
| J4709M | Socket, 1/4" DR 9 mm 6 PT | ASME B107.5M | |
| J4710M | Socket, 1/4" DR 10 mm 6 PT | ASME B107.5M | |
| J4711M | Socket, 1/4" DR 11 mm 6 PT | ASME B107.5M | |
| J4712M | Socket, 1/4" DR 12 mm 6 PT | ASME B107.5M | |
| J4713M | Socket, 1/4" DR 13 mm 6 PT | ASME B107.5M | |
| J4714M | Socket, 1/4" DR 14 mm 6 PT | ASME B107.5M | |
| J4749XL | Ratchet, 1/4" DR Standard Length Premium Pear Head 5-45/64" | ASME B107.500 | |
| J4759 | Extension, 1/4" DR 2" | ASME B107.500 | AS 4283 |
| J4761 | Extension, 1/4" DR 6" | ASME B107.500 | AS 4283 |
| J4769 | Driver, Socket 1/4" DR | ASME B107.500 | |
| J4770A | Universal Joint, 1/4" DR 1-11/32" | | |
| JBM1007 | Blow-Molded Case | | |





1/4" DRIVE 15 PIECE COMBINATION SOCKET SET - 6 POINT

Product #: J47112

- › 6 Point Standard: 3/16, 7/32, 1/4, 9/32, 5/16, 11/32, 3/8, 7/16, 1/2, 9/16 Inch.
- › Accessories: Pear Head Ratchet, 2 and 6 Inch Extensions, Socket Driver, Universal Joint, and Blow-Molded Case.
- › Weight (lbs): 2.73



| Contents | Description | ASME Spec. | AS Spec. |
|----------|---|---------------|----------|
| J4706 | Socket, 1/4" DR 3/16" 6 PT | ASME B107.1 | |
| J4707 | Socket, 1/4" DR 7/32" 6 PT | ASME B107.1 | |
| J4708 | Socket, 1/4" DR 1/4" 6 PT | ASME B107.1 | |
| J4709 | Socket, 1/4" DR 9/32" 6 PT | ASME B107.1 | |
| J4710 | Socket, 1/4" DR 5/16" 6 PT | ASME B107.1 | |
| J4711 | Socket, 1/4" DR 11/32" 6 PT | ASME B107.1 | |
| J4712 | Socket, 1/4" DR 3/8" 6 PT | ASME B107.1 | |
| J4714 | Socket, 1/4" DR 7/16" 6 PT | ASME B107.1 | |
| J4716 | Socket, 1/4" DR 1/2" 6 PT | ASME B107.1 | |
| J4718 | Socket, 1/4" DR 9/16" 6 PT | ASME B107.1 | |
| J4749 | Ratchet, 1/4" DR Standard Length Classic Pear Head 5" | ASME B107.500 | |
| J4759 | Extension, 1/4" DR 2" | ASME B107.500 | AS 4283 |
| J4761 | Extension, 1/4" DR 6" | ASME B107.500 | AS 4283 |
| J4769 | Driver, Socket 1/4" DR | ASME B107.500 | |
| J4770A | Universal Joint, 1/4" DR 1-11/32" | ASME B107.500 | |
| JBM1005 | Blow-Molded Case | | |

1/4" DRIVE 15 PIECE COMBINATION SOCKET SET - 6 POINT

Product #: J47112XL

- › 6 Point Standard: 3/16, 7/32, 1/4, 9/32, 5/16, 11/32, 3/8, 7/16, 1/2, 9/16 Inch.
- › Accessories: Premium Ratchet, Socket Driver, 2 and 6 Inch Extensions, Universal Joint, and Blow-Molded Case.
- › Weight (lbs): 1.82



| Contents | Description | ASME Spec. | AS Spec. |
|----------|---|---------------|----------|
| J4706 | Socket, 1/4" DR 3/16" 6 PT | ASME B107.1 | |
| J4707 | Socket, 1/4" DR 7/32" 6 PT | ASME B107.1 | |
| J4708 | Socket, 1/4" DR 1/4" 6 PT | ASME B107.1 | |
| J4709 | Socket, 1/4" DR 9/32" 6 PT | ASME B107.1 | |
| J4710 | Socket, 1/4" DR 5/16" 6 PT | ASME B107.1 | |
| J4711 | Socket, 1/4" DR 11/32" 6 PT | ASME B107.1 | |
| J4712 | Socket, 1/4" DR 3/8" 6 PT | ASME B107.1 | |
| J4714 | Socket, 1/4" DR 7/16" 6 PT | ASME B107.1 | |
| J4716 | Socket, 1/4" DR 1/2" 6 PT | ASME B107.1 | |
| J4718 | Socket, 1/4" DR 9/16" 6 PT | ASME B107.1 | |
| J4749XL | Ratchet, 1/4" DR Standard Length Premium Pear Head 5-45/64" | ASME B107.500 | |
| J4759 | Extension, 1/4" DR 2" | ASME B107.500 | AS 4283 |
| J4761 | Extension, 1/4" DR 6" | ASME B107.500 | AS 4283 |
| J4769 | Driver, Socket 1/4" DR | ASME B107.500 | |
| J4770A | Universal Joint, 1/4" DR 1-11/32" | | |
| JBM1005 | Blow-Molded Case | | |



1/4" DRIVE 12 PIECE COMBINATION SOCKET SET - 6 POINT

Product #: J47108

- ▶ 6 Point Standard: 3/16, 7/32, 1/4, 9/32, 5/16, 11/32, 3/8, 7/16, 1/2, 9/16 Inch.
- ▶ Accessories: Pear Head Ratchet, Socket Driver, and Blow-Molded Case.
- ▶ Weight (lbs): 1.62



| Contents | Description | ASME Spec. |
|----------|---|---------------|
| J4706 | Socket, 1/4" DR 3/16" 6 PT | ASME B107.1 |
| J4707 | Socket, 1/4" DR 7/32" 6 PT | ASME B107.1 |
| J4708 | Socket, 1/4" DR 1/4" 6 PT | ASME B107.1 |
| J4709 | Socket, 1/4" DR 9/32" 6 PT | ASME B107.1 |
| J4710 | Socket, 1/4" DR 5/16" 6 PT | ASME B107.1 |
| J4711 | Socket, 1/4" DR 11/32" 6 PT | ASME B107.1 |
| J4712 | Socket, 1/4" DR 3/8" 6 PT | ASME B107.1 |
| J4714 | Socket, 1/4" DR 7/16" 6 PT | ASME B107.1 |
| J4716 | Socket, 1/4" DR 1/2" 6 PT | ASME B107.1 |
| J4718 | Socket, 1/4" DR 9/16" 6 PT | ASME B107.1 |
| J4749 | Ratchet, 1/4" DR Standard Length Classic Pear Head 5" | ASME B107.500 |
| J4769 | Driver, Socket 1/4" DR | ASME B107.500 |
| JBM1001 | Blow-Molded Case | |

1/4" DRIVE 12 PIECE COMBINATION SOCKET SET - 6 POINT

Product #: J47108XL

- ▶ 6 Point Standard: 3/16, 7/32, 1/4, 9/32, 5/16, 11/32, 3/8, 7/16, 1/2, 9/16 Inch.
- ▶ Accessories: Premium Ratchet, Socket Driver, and Blow-Molded Case.
- ▶ Weight (lbs): 1.57



| Contents | Description | ASME Spec. |
|----------|---|---------------|
| J4706 | Socket, 1/4" DR 3/16" 6 PT | ASME B107.1 |
| J4707 | Socket, 1/4" DR 7/32" 6 PT | ASME B107.1 |
| J4708 | Socket, 1/4" DR 1/4" 6 PT | ASME B107.1 |
| J4709 | Socket, 1/4" DR 9/32" 6 PT | ASME B107.1 |
| J4710 | Socket, 1/4" DR 5/16" 6 PT | ASME B107.1 |
| J4711 | Socket, 1/4" DR 11/32" 6 PT | ASME B107.1 |
| J4712 | Socket, 1/4" DR 3/8" 6 PT | ASME B107.1 |
| J4714 | Socket, 1/4" DR 7/16" 6 PT | ASME B107.1 |
| J4716 | Socket, 1/4" DR 1/2" 6 PT | ASME B107.1 |
| J4718 | Socket, 1/4" DR 9/16" 6 PT | ASME B107.1 |
| J4749XL | Ratchet, 1/4" DR Standard Length Premium Pear Head 5-45/64" | ASME B107.500 |
| J4769 | Driver, Socket 1/4" DR | ASME B107.500 |
| JBM1001 | Blow-Molded Case | |





1/4" DRIVE 12 PIECE COMBINATION SOCKET SET - 12 POINT

Product #: J47110

- › 12 Point Standard: 3/16, 7/32, 1/4, 9/32, 5/16, 11/32, 3/8, 7/16, 1/2 and 9/16 Inch.
- › Accessories: Pear Head Ratchet, Socket Driver, and Blow-Molded Case.
- › Weight (lbs): 1.64



| Contents | Description | ASME Spec. | AS Spec. |
|----------|---|---------------|---------------|
| J4706T | Socket, 1/4" DR 3/16" 12 PT | ASME B107.1 | AS954E S3.8.1 |
| J4707T | Socket, 1/4" DR 7/32" 12 PT | ASME B107.1 | AS954E S3.8.1 |
| J4708T | Socket, 1/4" DR 1/4" 12 PT | ASME B107.1 | AS954E S3.8.1 |
| J4709T | Socket, 1/4" DR 9/32" 12 PT | ASME B107.1 | AS954E S3.8.1 |
| J4710T | Socket, 1/4" DR 5/16" 12 PT | ASME B107.1 | AS954E S3.8.1 |
| J4711T | Socket, 1/4" DR 11/32" 12 PT | ASME B107.1 | AS954E S3.8.1 |
| J4712T | Socket, 1/4" DR 3/8" 12 PT | ASME B107.1 | AS954E S3.8.1 |
| J4714T | Socket, 1/4" DR 7/16" 12 PT | ASME B107.1 | AS954E S3.8.1 |
| J4716T | Socket, 1/4" DR 1/2" 12 PT | ASME B107.1 | AS954E S3.8.1 |
| J4718T | Socket, 1/4" DR 9/16" 12 PT | ASME B107.1 | AS954E S3.8.1 |
| J4749 | Ratchet, 1/4" DR Standard Length Classic Pear Head 5" | ASME B107.500 | |
| J4769 | Driver, Socket 1/4" DR | ASME B107.500 | |
| JBM1001 | Blow-Molded Case | | |

1/4" DRIVE 12 PIECE COMBINATION SOCKET SET - 12 POINT

Product #: J47110XL

- › 12 Point Standard: 3/16, 7/32, 1/4, 9/32, 5/16, 11/32, 3/8, 7/16, 1/2, 9/16 Inch.
- › Accessories: Premium Ratchet, Socket Driver, and Blow-Molded Case.
- › Weight (lbs): 1.55



| Contents | Description | ASME Spec. | AS Spec. |
|----------|---|---------------|---------------|
| J4706T | Socket, 1/4" DR 3/16" 12 PT | ASME B107.1 | AS954E S3.8.1 |
| J4707T | Socket, 1/4" DR 7/32" 12 PT | ASME B107.1 | AS954E S3.8.1 |
| J4708T | Socket, 1/4" DR 1/4" 12 PT | ASME B107.1 | AS954E S3.8.1 |
| J4709T | Socket, 1/4" DR 9/32" 12 PT | ASME B107.1 | AS954E S3.8.1 |
| J4710T | Socket, 1/4" DR 5/16" 12 PT | ASME B107.1 | AS954E S3.8.1 |
| J4711T | Socket, 1/4" DR 11/32" 12 PT | ASME B107.1 | AS954E S3.8.1 |
| J4712T | Socket, 1/4" DR 3/8" 12 PT | ASME B107.1 | AS954E S3.8.1 |
| J4714T | Socket, 1/4" DR 7/16" 12 PT | ASME B107.1 | AS954E S3.8.1 |
| J4716T | Socket, 1/4" DR 1/2" 12 PT | ASME B107.1 | AS954E S3.8.1 |
| J4718T | Socket, 1/4" DR 9/16" 12 PT | ASME B107.1 | AS954E S3.8.1 |
| J4749XL | Ratchet, 1/4" DR Standard Length Premium Pear Head 5-45/64" | ASME B107.500 | |
| J4769 | Driver, Socket 1/4" DR | ASME B107.500 | |
| JBM1001 | Blow-Molded Case | | |



1/4" DRIVE 10 PIECE SOCKET SET - 12 POINT

Product #: **J47104**



- ▶ 12 Point Standard: 3/16, 7/32, 1/4, 9/32, 5/16, 11/32, 3/8, 7/16, 1/2, 9/16 Inch.
- ▶ Accessories: 6-1/4 Inch Socket Bar, 10 Socket Clips.
- ▶ Weight (lbs): 0.42



| Contents | Description | ASME Spec. | AS Spec. |
|----------|------------------------------|-------------|---------------|
| J4706T | Socket, 1/4" DR 3/16" 12 PT | ASME B107.1 | AS954E S3.8.1 |
| J4707T | Socket, 1/4" DR 7/32" 12 PT | ASME B107.1 | AS954E S3.8.1 |
| J4708T | Socket, 1/4" DR 1/4" 12 PT | ASME B107.1 | AS954E S3.8.1 |
| J4709T | Socket, 1/4" DR 9/32" 12 PT | ASME B107.1 | AS954E S3.8.1 |
| J4710T | Socket, 1/4" DR 5/16" 12 PT | ASME B107.1 | AS954E S3.8.1 |
| J4711T | Socket, 1/4" DR 11/32" 12 PT | ASME B107.1 | AS954E S3.8.1 |
| J4712T | Socket, 1/4" DR 3/8" 12 PT | ASME B107.1 | AS954E S3.8.1 |
| J4714T | Socket, 1/4" DR 7/16" 12 PT | ASME B107.1 | AS954E S3.8.1 |
| J4716T | Socket, 1/4" DR 1/2" 12 PT | ASME B107.1 | AS954E S3.8.1 |
| J4718T | Socket, 1/4" DR 9/16" 12 PT | ASME B107.1 | AS954E S3.8.1 |
| J2584 | Socket, Bar 6-1/4" | | |
| J2590 | Socket, Clip 1/4" DR | | |

1/4" DRIVE 11 PIECE METRIC SOCKET SET - 12 POINT

METRIC

Product #: **J47201**



- ▶ 12 Point Metric: 5, 5.5, 6, 7, 8, 9, 10, 11, 12, 13, 14 mm.
- ▶ Accessories: 9 Inch Socket Bar with 11 Socket Clips.
- ▶ Weight (lbs): 0.56



| Contents | Description | ASME Spec. | AS Spec. |
|----------|------------------------------|--------------|---------------|
| J4705TM | Socket, 1/4" DR 5 mm 12 PT | ASME B107.5M | AS954E S3.8.1 |
| J47055TM | Socket, 1/4" DR 5.5 mm 12 PT | ASME B107.5M | AS954E S3.8.1 |
| J4706TM | Socket, 1/4" DR 6 mm 12 PT | ASME B107.5M | AS954E S3.8.1 |
| J4707TM | Socket, 1/4" DR 7 mm 12 PT | ASME B107.5M | AS954E S3.8.1 |
| J4708TM | Socket, 1/4" DR 8 mm 12 PT | ASME B107.5M | AS954E S3.8.1 |
| J4709TM | Socket, 1/4" DR 9 mm 12 PT | ASME B107.5M | AS954E S3.8.1 |
| J4710TM | Socket, 1/4" DR 10 mm 12 PT | ASME B107.5M | AS954E S3.8.1 |
| J4711TM | Socket, 1/4" DR 11 mm 12 PT | ASME B107.5M | AS954E S3.8.1 |
| J4712TM | Socket, 1/4" DR 12 mm 12 PT | ASME B107.5M | AS954E S3.8.1 |
| J4713TM | Socket, 1/4" DR 13 mm 12 PT | ASME B107.5M | AS954E S3.8.1 |
| J4714TM | Socket, 1/4" DR 14 mm 12 PT | ASME B107.5M | AS954E S3.8.1 |
| J2585 | Socket, Bar 9" | | |
| J2590 | Socket, Clip 1/4" DR | | |



1/4" DRIVE 10 PIECE DEEP SOCKET SET - 12 POINT

Product #: J47100



- ▶ 12 Point Deep: 3/16, 7/32, 1/4, 9/32, 5/16, 11/32, 3/8, 7/16, 1/2, 9/16 Inch.
- ▶ Accessories: 6-1/4 Inch Socket Bar with 10 Socket Clips.
- ▶ Weight (lbs): 0.79



| Contents | Description | ASME Spec. | AS Spec. |
|----------|-----------------------------------|-------------|---------------|
| J4706LT | Socket, 1/4" DR 3/16" 12 PT Deep | ASME B107.1 | AS954E S3.8.1 |
| J4707LT | Socket, 1/4" DR 7/32" 12 PT Deep | ASME B107.1 | AS954E S3.8.1 |
| J4708LT | Socket, 1/4" DR 1/4" 12 PT Deep | ASME B107.1 | AS954E S3.8.1 |
| J4709LT | Socket, 1/4" DR 9/32" 12 PT Deep | ASME B107.1 | AS954E S3.8.1 |
| J4710LT | Socket, 1/4" DR 5/16" 12 PT Deep | ASME B107.1 | AS954E S3.8.1 |
| J4711LT | Socket, 1/4" DR 11/32" 12 PT Deep | ASME B107.1 | AS954E S3.8.1 |
| J4712LT | Socket, 1/4" DR 3/8" 12 PT Deep | ASME B107.1 | AS954E S3.8.1 |
| J4714LT | Socket, 1/4" DR 7/16" 12 PT Deep | ASME B107.1 | AS954E S3.8.1 |
| J4716LT | Socket, 1/4" DR 1/2" 12 PT Deep | ASME B107.1 | AS954E S3.8.1 |
| J4718LT | Socket, 1/4" DR 9/16" 12 PT Deep | ASME B107.1 | AS954E S3.8.1 |
| J2584 | Socket, Bar 6-1/4" | | |
| J2590 | Socket, Clip 1/4" DR | | |

1/4" DRIVE 11 PIECE METRIC DEEP SOCKET SET - 12 POINT

METRIC

Product #: J47203



- ▶ 12 Point Deep: 5, 5.5, 6, 7, 8, 9, 10, 11, 12, 13, 14 mm.
- ▶ Accessories: 9 Inch Socket Bar with 11 Socket Clips.
- ▶ Weight (lbs): 1.03



| Contents | Description | ASME Spec. | AS Spec. |
|-----------|-----------------------------------|--------------|---------------|
| J4705LTM | Socket, 1/4" DR 5 mm 12 PT Deep | ASME B107.5M | AS954E S3.8.1 |
| J47055LTM | Socket, 1/4" DR 5.5 mm 12 PT Deep | ASME B107.5M | AS954E S3.8.1 |
| J4706LTM | Socket, 1/4" DR 6 mm 12 PT Deep | ASME B107.5M | AS954E S3.8.1 |
| J4707LTM | Socket, 1/4" DR 7 mm 12 PT Deep | ASME B107.5M | AS954E S3.8.1 |
| J4708LTM | Socket, 1/4" DR 8 mm 12 PT Deep | ASME B107.5M | AS954E S3.8.1 |
| J4709LTM | Socket, 1/4" DR 9 mm 12 PT Deep | ASME B107.5M | AS954E S3.8.1 |
| J4710LTM | Socket, 1/4" DR 10 mm 12 PT Deep | ASME B107.5M | AS954E S3.8.1 |
| J4711LTM | Socket, 1/4" DR 11 mm 12 PT Deep | ASME B107.5M | AS954E S3.8.1 |
| J4712LTM | Socket, 1/4" DR 12 mm 12 PT Deep | ASME B107.5M | AS954E S3.8.1 |
| J4713LTM | Socket, 1/4" DR 13 mm 12 PT Deep | ASME B107.5M | AS954E S3.8.1 |
| J4714LTM | Socket, 1/4" DR 14 mm 12 PT Deep | ASME B107.5M | AS954E S3.8.1 |
| J2585 | Socket, Bar 9" | | |
| J2590 | Socket, Clip 1/4" DR | | |



1/4" DRIVE 10 PIECE SOCKET SET - 6 POINT

Product #: J47106



- ▶ 6 Point: 3/16, 7/32, 1/4, 9/32, 5/16, 11/32, 3/8, 7/16, 1/2, 9/16 Inch.
- ▶ Accessories: 6-1/4 Inch Socket Bar with 10 Socket Clips.
- ▶ Weight (lbs): 0.48



| Contents | Description | ASME Spec. |
|----------|-----------------------------|-------------|
| J4706 | Socket, 1/4" DR 3/16" 6 PT | ASME B107.1 |
| J4707 | Socket, 1/4" DR 7/32" 6 PT | ASME B107.1 |
| J4708 | Socket, 1/4" DR 1/4" 6 PT | ASME B107.1 |
| J4709 | Socket, 1/4" DR 9/32" 6 PT | ASME B107.1 |
| J4710 | Socket, 1/4" DR 5/16" 6 PT | ASME B107.1 |
| J4711 | Socket, 1/4" DR 11/32" 6 PT | ASME B107.1 |
| J4712 | Socket, 1/4" DR 3/8" 6 PT | ASME B107.1 |
| J4714 | Socket, 1/4" DR 7/16" 6 PT | ASME B107.1 |
| J4716 | Socket, 1/4" DR 1/2" 6 PT | ASME B107.1 |
| J4718 | Socket, 1/4" DR 9/16" 6 PT | ASME B107.1 |
| J2584 | Socket, Bar 6-1/4" | |
| J2590 | Socket, Clip 1/4" DR | |

1/4" DRIVE 12 PIECE METRIC SOCKET SET - 6 POINT

METRIC

Product #: J47200



- ▶ 6 Point: 4, 5, 5.5, 6, 7, 8, 9, 10, 11, 12, 13, 14 mm.
- ▶ Accessories: 9 Inch Socket Bar with 12 Socket Clips.
- ▶ Weight (lbs): 0.58



| Contents | Description | ASME Spec. |
|----------|-----------------------------|--------------|
| J4704M | Socket, 1/4" DR 4 mm 6 PT | ASME B107.5M |
| J4705M | Socket, 1/4" DR 5 mm 6 PT | ASME B107.5M |
| J47055M | Socket, 1/4" DR 5.5 mm 6 PT | ASME B107.5M |
| J4706M | Socket, 1/4" DR 6 mm 6 PT | ASME B107.5M |
| J4707M | Socket, 1/4" DR 7 mm 6 PT | ASME B107.5M |
| J4708M | Socket, 1/4" DR 8 mm 6 PT | ASME B107.5M |
| J4709M | Socket, 1/4" DR 9 mm 6 PT | ASME B107.5M |
| J4710M | Socket, 1/4" DR 10 mm 6 PT | ASME B107.5M |
| J4711M | Socket, 1/4" DR 11 mm 6 PT | ASME B107.5M |
| J4712M | Socket, 1/4" DR 12 mm 6 PT | ASME B107.5M |
| J4713M | Socket, 1/4" DR 13 mm 6 PT | ASME B107.5M |
| J4714M | Socket, 1/4" DR 14 mm 6 PT | ASME B107.5M |
| J2585 | Socket, Bar 9" | |
| J2590 | Socket, Clip 1/4" DR | |





1/4" DRIVE 10 PIECE DEEP SOCKET SET - 6 POINT

Product #: J47102

- ▶ 6 Point Deep: 3/16, 7/32, 1/4, 9/32, 5/16, 11/32, 3/8, 7/16, 1/2, 9/16 Inch.
- ▶ Accessories: 6-1/4 Inch Socket Bar with 10 Socket Clips.
- ▶ Weight (lbs): 0.87



| Contents | Description | ASME Spec. |
|----------|----------------------------------|-------------|
| J4706L | Socket, 1/4" DR 3/16" 6 PT Deep | ASME B107.1 |
| J4707L | Socket, 1/4" DR 7/32" 6 PT Deep | ASME B107.1 |
| J4708L | Socket, 1/4" DR 1/4" 6 PT Deep | ASME B107.1 |
| J4709L | Socket, 1/4" DR 9/32" 6 PT Deep | ASME B107.1 |
| J4710L | Socket, 1/4" DR 5/16" 6 PT Deep | ASME B107.1 |
| J4711L | Socket, 1/4" DR 11/32" 6 PT Deep | ASME B107.1 |
| J4712L | Socket, 1/4" DR 3/8" 6 PT Deep | ASME B107.1 |
| J4714L | Socket, 1/4" DR 7/16" 6 PT Deep | ASME B107.1 |
| J4716L | Socket, 1/4" DR 1/2" 6 PT Deep | ASME B107.1 |
| J4718L | Socket, 1/4" DR 9/16" 6 PT Deep | ASME B107.1 |
| J2584 | Socket, Bar 6-1/4" | |
| J2590 | Socket, Clip 1/4" DR | |

1/4" DRIVE 12 PIECE METRIC DEEP SOCKET SET - 6 POINT

METRIC

Product #: J47202

- ▶ 6 Point Deep: 4, 5, 5.5, 6, 7, 8, 9, 10, 11, 12, 13, 14 mm.
- ▶ Accessories: 9 Inch Socket Bar with 12 Socket Clips.
- ▶ Weight (lbs): 1.10



| Contents | Description | ASME Spec. |
|----------|----------------------------------|--------------|
| J4704LM | Socket, 1/4" DR 4 mm 6 PT Deep | ASME B107.5M |
| J4705LM | Socket, 1/4" DR 5 mm 6 PT Deep | ASME B107.5M |
| J47055LM | Socket, 1/4" DR 5.5 mm 6 PT Deep | ASME B107.5M |
| J4706LM | Socket, 1/4" DR 6 mm 6 PT Deep | ASME B107.5M |
| J4707LM | Socket, 1/4" DR 7 mm 6 PT Deep | ASME B107.5M |
| J4708LM | Socket, 1/4" DR 8 mm 6 PT Deep | ASME B107.5M |
| J4709LM | Socket, 1/4" DR 9 mm 6 PT Deep | ASME B107.5M |
| J4710LM | Socket, 1/4" DR 10 mm 6 PT Deep | ASME B107.5M |
| J4711LM | Socket, 1/4" DR 11 mm 6 PT Deep | ASME B107.5M |
| J4712LM | Socket, 1/4" DR 12 mm 6 PT Deep | ASME B107.5M |
| J4713LM | Socket, 1/4" DR 13 mm 6 PT Deep | ASME B107.5M |
| J4714LM | Socket, 1/4" DR 14 mm 6 PT Deep | ASME B107.5M |
| J2585 | Socket, Bar 9" | |
| J2590 | Socket, Clip 1/4" DR | |



1/4" DRIVE 9 PIECE UNIVERSAL SOCKET SET - 12 POINT

Product #: **J47107**

- ▶ 12 Point: 7/32, 1/4, 9/32, 5/16, 11/32, 3/8, 7/16, 1/2, 9/16 Inch.
- ▶ Accessories: 6-1/4 Inch Socket Bar with 9 Socket Clips.
- ▶ Weight (lbs): 0.47



| Contents | Description | ASME Spec. | AS Spec. |
|----------|--|-------------|---------------|
| J4770TA | Socket, Universal 1/4" DR 7/32" 12 PT | ASME B107.1 | AS954E S3.8.1 |
| J4771TA | Socket, Universal 1/4" DR 1/4" 12 PT | ASME B107.1 | AS954E S3.8.1 |
| J4772TA | Socket, Universal 1/4" DR 5/16" 12 PT | ASME B107.1 | AS954E S3.8.1 |
| J4773TA | Socket, Universal 1/4" DR 3/8" 12 PT | ASME B107.1 | AS954E S3.8.1 |
| J4774TA | Socket, Universal 1/4" DR 7/16" 12 PT | ASME B107.1 | AS954E S3.8.1 |
| J4775TA | Socket, Universal 1/4" DR 1/2" 12 PT | ASME B107.1 | AS954E S3.8.1 |
| J4776TA | Socket, Universal 1/4" DR 9/16" 12 PT | ASME B107.1 | AS954E S3.8.1 |
| J4777TA | Socket, Universal 1/4" DR 9/32" 12 PT | ASME B107.1 | AS954E S3.8.1 |
| J4778TA | Socket, Universal 1/4" DR 11/32" 12 PT | ASME B107.1 | AS954E S3.8.1 |
| J2584 | Socket, Bar 6-1/4" | | |
| J2590 | Socket, Clip 1/4" DR | | |

1/4" DRIVE 5 PIECE UNIVERSAL SOCKET SET - 12 POINT

Product #: **J47105**

- ▶ 12 Point: 1/4, 5/16, 3/8, 7/16, 1/2 Inch.
- ▶ Accessories: 6-1/4 Inch Socket Bar with 5 Socket Clips.
- ▶ Weight (lbs): 0.32



| Contents | Description | ASME Spec. | AS Spec. |
|----------|---------------------------------------|-------------|---------------|
| J4771TA | Socket, Universal 1/4" DR 1/4" 12 PT | ASME B107.1 | AS954E S3.8.1 |
| J4772TA | Socket, Universal 1/4" DR 5/16" 12 PT | ASME B107.1 | AS954E S3.8.1 |
| J4773TA | Socket, Universal 1/4" DR 3/8" 12 PT | ASME B107.1 | AS954E S3.8.1 |
| J4774TA | Socket, Universal 1/4" DR 7/16" 12 PT | ASME B107.1 | AS954E S3.8.1 |
| J4775TA | Socket, Universal 1/4" DR 1/2" 12 PT | ASME B107.1 | AS954E S3.8.1 |
| J2584 | Socket, Bar 6-1/4" | | |
| J2590 | Socket, Clip 1/4" DR | | |

1/4" DRIVE 12 PIECE METRIC UNIVERSAL SOCKET SET - 6 POINT

METRIC

Product #: **J47205**

- ▶ 12 Point: 5, 5.5, 6, 7, 8, 9, 10, 11, 12, 13, 14, 15 mm.
- ▶ Accessories: 9 Inch Socket Bar with 12 Clips.
- ▶ Weight (lbs): 0.67



| Contents | Description | ASME Spec. |
|----------|---------------------------------------|--------------|
| J4805AM | Socket, 1/4" DR 5 mm 6 PT Universal | ASME B107.5M |
| J48055AM | Socket, 1/4" DR 5.5 mm 6 PT Universal | ASME B107.5M |
| J4806AM | Socket, 1/4" DR 6 mm 6 PT Universal | ASME B107.5M |
| J4807AM | Socket, 1/4" DR 7 mm 6 PT Universal | ASME B107.5M |
| J4808AM | Socket, 1/4" DR 8 mm 6 PT Universal | ASME B107.5M |
| J4809AM | Socket, 1/4" DR 9 mm 6 PT Universal | ASME B107.5M |
| J4810AM | Socket, 1/4" DR 10 mm 6 PT Universal | ASME B107.5M |
| J4811AM | Socket, 1/4" DR 11 mm 6 PT Universal | ASME B107.5M |
| J4812AM | Socket, 1/4" DR 12 mm 6 PT Universal | ASME B107.5M |
| J4813AM | Socket, 1/4" DR 13 mm 6 PT Universal | ASME B107.5M |
| J4814AM | Socket, 1/4" DR 14 mm 6 PT Universal | ASME B107.5M |
| J4815AM | Socket, 1/4" DR 15 mm 6 PT Universal | ASME B107.5M |
| J2585 | Socket, Bar 9" | |
| J2590 | Socket, Clip 1/4" DR | |



1/4" DRIVE 6 PIECE METRIC HEX BIT SET

METRIC

Product #: J4770-6

| Contents | Description |
|------------|--------------------------------|
| J4770-2M | Socket, Hex Bit 1/4" DR 2 mm |
| J4770-2.5M | Socket, Hex Bit 1/4" DR 2.5 mm |
| J4770-3M | Socket, Hex Bit 1/4" DR 3 mm |
| J4770-4M | Socket, Hex Bit 1/4" DR 4 mm |
| J4770-5M | Socket, Hex Bit 1/4" DR 5 mm |
| J4770-6M | Socket, Hex Bit 1/4" DR 6 mm |
| J2584 | Socket, Bar 6-1/4" |
| J2590 | Socket, Clip 1/4" DR |

Weight (lbs): 0.41



1/4" DRIVE 8 PIECE HEX BIT BALL END SOCKET SET

Product #: J4770-8B

| Contents | Description |
|------------|-------------------------------|
| J47701/4B | Socket, Hex Bit 1/4" DR 1/4" |
| J47701/8B | Socket, Hex Bit 1/4" DR 1/8" |
| J47703/16B | Socket, Hex Bit 1/4" DR 3/16" |
| J47703/32B | Socket, Hex Bit 1/4" DR 3/32" |
| J47705/32B | Socket, Hex Bit 1/4" DR 5/32" |
| J47707/32B | Socket, Hex Bit 1/4" DR 7/32" |
| J47707/64B | Socket, Hex Bit 1/4" DR 7/64" |
| J47709/64B | Socket, Hex Bit 1/4" DR 9/64" |
| J2584 | Socket, Bar 6-1/4" |
| J2590 | Socket, Clip 1/4" DR |

Weight (lbs): 0.49



1/4" DRIVE 11 PIECE HEX BIT SET

Product #: J4770-11

| Contents | Description |
|-----------|-------------------------------|
| J47701/16 | Socket, 1/4" DR Hex Bit 1/16" |
| J47705/64 | Socket, 1/4" DR Hex Bit 5/64" |
| J47707/64 | Socket, 1/4" DR Hex Bit 7/64" |
| J47703/32 | Socket, 1/4" DR Hex Bit 3/32" |
| J47701/8 | Socket, 1/4" DR Hex Bit 1/8" |
| J47709/64 | Socket, 1/4" DR Hex Bit 9/64" |
| J47705/32 | Socket, 1/4" DR Hex Bit 5/32" |
| J47703/16 | Socket, 1/4" DR Hex Bit 3/16" |
| J47707/32 | Socket, 1/4" DR Hex Bit 7/32" |
| J47701/4 | Socket, 1/4" DR Hex Bit 1/4" |
| J47705/16 | Socket, 1/4" DR Hex Bit 5/16" |
| J2584 | Socket, Bar 6-1/4" |
| J2590 | Socket, Clip 1/4" DR |

Weight (lbs): 0.64



1/4" DRIVE 6 PIECE TORX® BIT SET

Product #: J4739C

| Contents | Description |
|-----------|-------------------------------|
| J4739-10W | Socket, Bit 1/4" DR T10 Torx® |
| J4739-15W | Socket, Bit 1/4" DR T15 Torx® |
| J4739-20W | Socket, Bit 1/4" DR T20 Torx® |
| J4739-25W | Socket, Bit 1/4" DR T25 Torx® |
| J4739-27W | Socket, Bit 1/4" DR T27 Torx® |
| J4739-30W | Socket, Bit 1/4" DR T30 Torx® |
| J2584 | Socket, Bar 6-1/4" |
| J2590 | Socket, Clip 1/4" DR |

Weight (lbs): 0.38





1/4" DRIVE 6 PIECE CROWFOOT WRENCH SET

Product #: **J47000CF**



▶ Weight (lbs): 0.41

| Contents | Description |
|----------|---|
| J4708CF | Wrench, Crowfoot 1/4" DR 1/4" Open End |
| J4710CF | Wrench, Crowfoot 1/4" DR 5/16" Open End |
| J4712CF | Wrench, Crowfoot 1/4" DR 3/8" Open End |
| J4714CF | Wrench, Crowfoot 1/4" DR 7/16" Open End |
| J4716CF | Wrench, Crowfoot 1/4" DR 1/2" Open End |
| J4718CF | Wrench, Crowfoot 1/4" DR 9/16" Open End |



1/4" DRIVE 8 PIECE CROWFOOT WRENCH SET WITH LOCKING EXTENSIONS

Product #: **J47000CFL**



▶ Weight (lbs): 0.63

| Contents | Description | ASME Spec. |
|----------|---|---------------|
| J4708CF | Wrench, Crowfoot 1/4" DR 1/4" Open End | |
| J4710CF | Wrench, Crowfoot 1/4" DR 5/16" Open End | |
| J4712CF | Wrench, Crowfoot 1/4" DR 3/8" Open End | |
| J4714CF | Wrench, Crowfoot 1/4" DR 7/16" Open End | |
| J4716CF | Wrench, Crowfoot 1/4" DR 1/2" Open End | |
| J4718CF | Wrench, Crowfoot 1/4" DR 9/16" Open End | |
| J4761L | Extension, 1/4" DR Locking 6" | ASME B107.500 |
| J4759L | Extension, 1/4" DR Locking 2" | ASME B107.500 |



1/4" DRIVE 7 PIECE METRIC CROWFOOT WRENCH SET

METRIC

Product #: **J47000MCF**



▶ Weight (lbs): 0.47

| Contents | Description |
|----------|---|
| J4707MCF | Wrench, Crowfoot 1/4" DR 7 mm Open End |
| J4708MCF | Wrench, Crowfoot 1/4" DR 8 mm Open End |
| J4710MCF | Wrench, Crowfoot 1/4" DR 10 mm Open End |
| J4711MCF | Wrench, Crowfoot 1/4" DR 11 mm Open End |
| J4712MCF | Wrench, Crowfoot 1/4" DR 12 mm Open End |
| J4713MCF | Wrench, Crowfoot 1/4" DR 13 mm Open End |
| J4714MCF | Wrench, Crowfoot 1/4" DR 14 mm Open End |





1/4" DRIVE STANDARD LENGTH PREMIUM PEAR HEAD RATCHETS



- › Small pear head design for access in tight, hard to reach work areas.
- › 45-tooth gear provides balance between 8° articulation angle and high torque carrying capacity.
- › Sealed design helps prevent debris from entering the ratchet mechanism reducing wear. Also, helps to keep lubrication contained within the components. Patent pending design.
- › Low profile reversing lever design for quick, one-hand operation.
- › Contoured, ergonomically-designed handle for comfort. Knurled bands allow for increased grip and slip resistance.
- › Double nickel chrome plated for enhanced corrosion protection or black oxide finish.
- › Field repairable.



| Product # | Drive Size (in) | Finish | Overall Length (in) | Weight (lbs) | Repair Kit |
|------------------|-----------------|-------------|---------------------|--------------|------------|
| J4749XL | 1/4 | Full Polish | 5-45/64 | 0.25 | J4749XLRK |
| J4749XLBL | 1/4 | Black Oxide | 5-45/64 | 0.25 | J4749XLRK |



ASME B107.500

1/4" DRIVE QUICK RELEASE PREMIUM PEAR HEAD RATCHET



- › Small, pear head design for access in tight, hard to reach work areas.
- › 45-tooth gear, 8° swing articulation.
- › Low profile quick release button for access in restricted areas.
- › Low profile reversing lever design for quick, one-hand operation.
- › Patented sealed head design helps prevent debris from entering the ratchet mechanism reducing wear. Also, helps to keep lubrication contained within the components.
- › Contoured, ergonomically-designed handle for comfort. Knurled bands allow for increased grip and slip resistance.
- › Full polished handle, easy to clean.
- › Double nickel chrome plated for enhanced corrosion protection meeting aerospace requirements.
- › Field repairable.



| Product # | Drive Size (in) | Finish | Overall Length (in) | Weight (lbs) | Repair Kit |
|--------------------|-----------------|-------------|---------------------|--------------|-------------|
| J4749XLQR | 1/4 | Full Polish | 6-11/16 | 0.25 | J4749XLQRRK |
| J4749XLQRBL | 1/4 | Black | 6-11/16 | 0.25 | J4749XLQRRK |



ASME B107.10

1/4" DRIVE AEROSPACE PREMIUM PEAR HEAD RATCHETS



- › Vertical hole drilled in drive plug, designed for installation of frangible collars on threaded pins.
- › Robust 45-tooth gear pawl design provides 8° ratcheting angle while maximizing ultimate torque.
- › Thin head design for access into tight work areas.
- › Reversing lever designed for quick, one-hand operation.
- › Full polish nickel chrome plated.



| Product # | Drive Size (in) | Finish | Overall Length (in) | Weight (lbs) | Repair Kit |
|------------------|-----------------|-------------|---------------------|--------------|---------------|
| J4749XLHS | 1/4 | Full Polish | 5-45/64 | 0.25 | J4749XLHSRK |
| | | | | | ASME B107.500 |

1/4" DRIVE STANDARD LENGTH CLASSIC PEAR HEAD RATCHETS

- › Robust 24-tooth gear/floating pawl design provides 15° ratcheting angle while maximizing ultimate torque.
- › Thin head design for access into tight work areas.
- › Reversing lever designed for quick, one-hand operation.



| Product # | Drive Size (in) | Finish | Overall Length (in) | Weight (lbs) | Repair Kit |
|----------------|-----------------|-------------|---------------------|--------------|---------------|
| J4749 | 1/4 | Full Polish | 5 | 0.26 | J4749RK |
| J4749BL | 1/4 | Black Oxide | 5 | 0.24 | J4749RK |
| | | | | | ASME B107.500 |

1/4" DRIVE AEROSPACE CLASSIC PEAR HEAD RATCHET

- › Vertical hole drilled in drive plug, designed for installation of frangible collars on threaded pins.
- › Metal spring clip on drive plug for positive socket retention.
- › 24-tooth gear provides 15° articulation angle.
- › Thin head design for access into tight work areas.
- › Reversing lever designed for quick, one-hand operation.
- › Full polish double nickel chrome plated.



| Product # | Drive Size (in) | Finish | Overall Length (in) | Weight (lbs) | Repair Kit |
|----------------|-----------------|-------------|---------------------|--------------|---------------|
| J4749HS | 1/4 | Full Polish | 5 | 0.25 | J4749RK |
| | | | | | ASME B107.500 |





1/4" DRIVE STANDARD LENGTH ROUND HEAD RATCHET

- › Round head ratchet mechanism allows for a compact head.
- › 72-tooth = 5° swing arc.
- › Small head design and tight swing arc allow for fastener access in tight areas.
- › Full polish shaft with knurled grip for strong slip-resistant grip.



| Product # | Drive Size (in) | Finish | Overall Length (in) | Weight (lbs) | Repair Kit |
|---------------|-----------------|-------------|---------------------|--------------|---------------------------|
| J4752F | 1/4 | Full Polish | 4-1/2 | 0.26 | J4752FRK ASME B107.500 |

1/4" DRIVE FLEX-HEAD RATCHET

- › 180° flex.
- › 72-tooth gear.
- › 5° ratcheting angle.
- › Small head design and tight swing to allow access to fastener in a tight area.
- › Full polish shaft with knurled grip allows for a strong slip-resistant grip.



| Product # | Drive Size (in) | Finish | Overall Length (in) | Weight (lbs) | Repair Kit |
|---------------|-----------------|-------------|---------------------|--------------|---------------------------|
| J4757F | 1/4 | Full Polish | 6-37/64 | 0.32 | J4752FRK ASME B107.500 |

1/4" DRIVE SOCKET DRIVER

- › 1/4" square female drive in handle.

| Product # | Drive Size (in) | Finish | Overall Length (in) | Weight (lbs) |
|--------------|-----------------|-------------|---------------------|--------------|
| J4769 | 1/4 | Full Polish | 6 | 0.22 |

 ASME B107.500

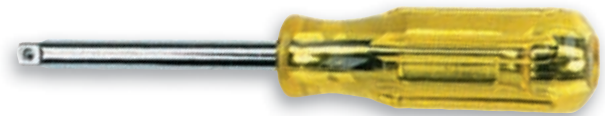

1/4" DRIVE FLEXIBLE DRIVER

- › Flexible shaft for bending around obstructions in low torque applications.

| Product # | Drive Size (in) | Finish | Overall Length (in) | Weight (lbs) |
|--------------|-----------------|--------|---------------------|--------------|
| J4764 | 1/4 | Chrome | 6-3/4 | 0.19 |





1/4" DRIVE SPEED HANDLE

- › Made from alloy steel.
- › Heat-treated for strength and durability.

| Product # | Drive Size (in) | Finish | Overall Length (in) | Weight (lbs) |
|---|-----------------|-------------|---------------------|--------------|
| J4780G | 1/4 | Full Polish | 15-1/2 | 0.52 |
|  ASME B107.500 | | | | |



1/4" DRIVE SLIDING T-HANDLE

- › Made from alloy steel.
- › Heat-treated for strength and durability.

| Product # | Drive Size (in) | Finish | Overall Length (in) | Weight (lbs) |
|---|-----------------|-------------|---------------------|--------------|
| J4785 | 1/4 | Full Polish | 4-1/2 | 0.08 |
|  ASME B107.500 | | | | |



1/4" DRIVE HINGE HANDLE

| Product # | Drive Size (in) | Finish | Overall Length (in) | Weight (lbs) |
|---|-----------------|-------------|---------------------|--------------|
| J4766 | 1/4 | Full Polish | 5-3/4 | 0.22 |
|  ASME B107.500 | | | | |



1/4" DRIVE STANDARD EXTENSIONS

- › Extensions help provide access to fasteners in areas that might otherwise be difficult to reach.

| Product # | Drive Size (in) | Finish | Overall Length (in) | Weight (lbs) |
|---|-----------------|-------------|---------------------|--------------|
| J4759 | 1/4 | Full Polish | 2 | 0.05 |
| J4760 | 1/4 | Full Polish | 3 | 0.08 |
| J4761 | 1/4 | Full Polish | 6 | 0.15 |
| J4762 | 1/4 | Full Polish | 10 | 0.24 |
| J4763 | 1/4 | Full Polish | 14-3/32 | 0.30 |
|  ASME B107.500 | | | | |



1/4" DRIVE LOCKING EXTENSIONS

- › One-piece extension design.
- › Provides positive socket retention.
- › Use where accidental socket disengagement may be a concern or safety hazard.

| Product # | Drive Size (in) | Finish | Overall Length (in) | Weight (lbs) |
|---|-----------------|-------------|---------------------|--------------|
| J4759L | 1/4 | Full Polish | 2 | 0.07 |
| J4761L | 1/4 | Full Polish | 6 | 0.15 |
| J4762L | 1/4 | Full Polish | 10 | 0.25 |
| J4763L | 1/4 | Full Polish | 14-3/32 | 0.33 |
|  ASME B107.500 | | | | |





1/4" DRIVE WOBBLE EXTENSIONS

- › Provides up to 17° angle of operation.
- › Socket can be pushed past the detent ball for straight driving.

| Product # | Drive Size (in) | Finish | Overall Length (in) | Weight (lbs) |
|-----------|-----------------|-------------|---------------------|--------------|
| J4759W | 1/4 | Full Polish | 2 | 0.06 |
| J4760W | 1/4 | Full Polish | 3 | 0.07 |
| J4764W | 1/4 | Full Polish | 4 | 0.10 |
| J4761W | 1/4 | Full Polish | 6 | 0.14 |
| J4762W | 1/4 | Full Polish | 10 | 0.20 |

ASME B107.500



1/4" DRIVE FLEXIBLE EXTENSION

- › Flexible shaft extensions help reach around obstructions in low torque applications.

| Product # | Drive Size (in) | Finish | Overall Length (in) | Weight (lbs) |
|-----------|-----------------|-------------|---------------------|--------------|
| J4765 | 1/4 | Full Polish | 6-1/4 | 0.11 |

ASME B107.500



1/4" DRIVE ADAPTERS

| Product # | Drive Size (in) | Finish | Overall Length (in) | Weight (lbs) |
|-----------|-----------------|-------------|---------------------|--------------|
| J5255 | 3/8" F x 1/4" M | Full Polish | 1 | 0.05 |
| J5256 | 1/4" F x 3/8" M | Full Polish | 1 | 0.04 |

ASME B107.500



1/4" DRIVE UNIVERSAL JOINT

| Product # | Drive Size (in) | Finish | Overall Length (in) | Weight (lbs) |
|-----------|-----------------|-------------|---------------------|--------------|
| J4770A | 1/4 | Full Polish | 1-11/32 | 0.04 |

ASME B107.500



1/4" DRIVE LOCKING ADAPTERS

- › Includes hex key for easy locking into drive tool.
- › Knurl locking ring.

| Product # | Drive Size (in) | Finish | Overall Length (in) | Weight (lbs) |
|-----------|-----------------|-------------|---------------------|--------------|
| J4759BLS | 1/4 | Black Oxide | 1-11/16 | 0.06 |

ASME B107.500





1/4" DRIVE SOCKETS - 6 POINT

- ▶ Proto® 6 Point Sockets are ideal for use on stubborn or damaged fasteners, and also on fasteners made from soft materials.
- ▶ TorquePlus™ features apply.



| Product # | Nut End Outside Dia. (in) (B) | Drive End Outside Dia. (in) (C) | Nut Depth (in) (D) | Bolt Clearance Depth (in) (E) | Overall Length (in) (L) | Weight (lbs) |
|-----------|----------------------------------|------------------------------------|-----------------------|----------------------------------|----------------------------|--------------|
| J4704 | 1/4 | 5/32 | 15/32 | 11/32 | 7/8 | 0.02 |
| J4705 | 17/64 | 31/64 | 11/64 | 11/32 | 7/8 | 0.03 |
| J4706 | 5/16 | 31/64 | 13/64 | 11/32 | 7/8 | 0.03 |
| J4707 | 11/32 | 31/64 | 13/64 | 11/32 | 7/8 | 0.02 |
| J4708 | 11/32 | 31/64 | 7/32 | 11/32 | 7/8 | 0.02 |
| J4709 | 27/64 | 31/64 | 1/4 | 11/32 | 7/8 | 0.02 |
| J4710 | 31/64 | 31/64 | 19/64 | 9/16 | 7/8 | 0.03 |
| J4711 | 33/64 | 33/64 | 11/32 | 17/32 | 7/8 | 0.03 |
| J4712 | 9/16 | 11/32 | 17/32 | 17/32 | 7/8 | 0.03 |
| J4714 | 5/8 | 5/8 | 23/64 | 17/32 | 7/8 | 0.05 |
| J4716 | 11/16 | 11/16 | 23/64 | 17/32 | 7/8 | 0.06 |
| J4718 | 47/64 | 47/64 | 23/64 | 9/16 | 7/8 | 0.07 |
| J4720A | 5/8 | 3/8 | 7/8 | 9/16 | 7/8 | 0.09 |



ASME B107.1

1/4" DRIVE METRIC SOCKETS - 6 POINT

- ▶ Proto® 6 Point Sockets are ideal for use on stubborn or damaged fasteners, and also on fasteners made from soft materials.
- ▶ TorquePlus™ features apply.



METRIC

| Product # | Size (mm) (A) | Nut End Outside Dia. (in) (B) | Drive End Outside Dia. (in) (C) | Nut Depth (in) (D) | Bolt Clearance Depth (in) (E) | Overall Length (in) (L) | Weight (lbs) |
|-----------|------------------|----------------------------------|------------------------------------|-----------------------|----------------------------------|----------------------------|-----------------|
| J4704M | 4 | 17/64 | 15/32 | 11/64 | 13/32 | 7/8 | 0.01 |
| J47045M | 4.5 | 5/16 | 15/32 | 11/64 | 13/32 | 7/8 | 0.01 |
| J4705M | 5 | 5/16 | 15/32 | 11/64 | 13/32 | 7/8 | 0.02 |
| J47055M | 5.5 | 21/64 | 15/32 | 11/64 | 13/32 | 7/8 | 0.02 |
| J4706M | 6 | 3/8 | 15/32 | 7/32 | 13/32 | 7/8 | 0.02 |
| J4707M | 7 | 27/64 | 15/32 | 1/4 | 15/32 | 7/8 | 0.02 |
| J4708M | 8 | 15/32 | 15/32 | 19/64 | 35/64 | 7/8 | 0.04 |
| J4709M | 9 | 33/64 | 33/64 | 23/64 | 35/64 | 7/8 | 0.03 |
| J4710M | 10 | 37/64 | 37/64 | 23/64 | 35/64 | 7/8 | 0.04 |
| J4711M | 11 | 5/8 | 5/8 | 23/64 | 35/64 | 7/8 | 0.05 |
| J4712M | 12 | 21/32 | 21/32 | 23/64 | 35/64 | 7/8 | 0.05 |
| J4713M | 13 | 11/16 | 11/16 | 23/64 | 35/64 | 7/8 | 0.05 |
| J4714M | 14 | 3/4 | 3/4 | 23/64 | 9/16 | 7/8 | 0.06 |
| J4715M | 15 | 51/64 | 51/64 | 23/64 | 9/16 | 7/8 | 0.08 |
| J4716M | 16 | 7/8 | 7/8 | 3/8 | 9/16 | 7/8 | 0.09 |



ASME B107.5M

FEATURES AND BENEFITS —



- ▶ High performance drive configuration allows for quick and easy socket engagement to the fastener flats, not the corners.
- ▶ Employs a radius-corner design, shifting contact area and stress away from the fastener corners and distributing contact stresses over a large area of the socket, minimizing slippage.
- ▶ The internal design minimizes fastener rounding, helps to extend fastener life, and allows the user to more easily turn worn, rounded, or rusted fasteners.

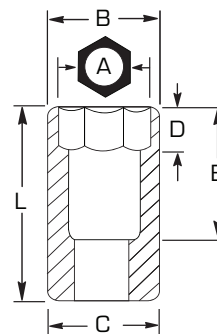



1/4" DRIVE DEEP SOCKETS - 6 POINT

- › Proto® 6 Point Sockets are ideal for use on stubborn or damaged fasteners, and also on fasteners made from soft materials.
- › TorquePlus™ features apply.



| Product # | Size (in) (A) | Nut End Outside Dia. (in) (B) | Drive End Outside Dia. (in) (C) | Nut Depth (in) (D) | Bolt Clearance Depth (in) (E) | Overall Length (in) (L) | Weight (lbs) |
|---------------|---------------|-------------------------------|---------------------------------|--------------------|-------------------------------|-------------------------|--------------|
| J4706L | 3/16 | 5/16 | 15/32 | 9/32 | 1-21/32 | 2 | 0.05 |
| J4707L | 7/32 | 11/32 | 15/32 | 3/8 | 1-21/32 | 2 | 0.05 |
| J4708L | 1/4 | 25/64 | 15/32 | 3/8 | 1-1/2 | 2 | 0.05 |
| J4709L | 9/32 | 7/16 | 15/32 | 3/8 | 1-1/2 | 2 | 0.05 |
| J4710L | 5/16 | 15/32 | 15/32 | 3/8 | 1-1/2 | 2 | 0.06 |
| J4711L | 11/32 | 1/2 | 1/2 | 5/8 | 1-1/2 | 2 | 0.06 |
| J4712L | 3/8 | 9/16 | 9/16 | 5/8 | 1-27/64 | 2 | 0.08 |
| J4714L | 7/16 | 37/64 | 39/64 | 5/8 | 1-27/64 | 2 | 0.09 |
| J4716L | 1/2 | 11/16 | 11/16 | 5/8 | 1-27/64 | 2 | 0.13 |
| J4718L | 9/16 | 3/4 | 3/4 | 5/8 | 1-27/64 | 2 | 0.14 |



ASME B107.1

1/4" DRIVE METRIC DEEP SOCKETS - 6 POINT

- › Proto® 6 Point Sockets are ideal for use on stubborn or damaged fasteners, and also on fasteners made from soft materials.
- › TorquePlus™ features apply.



| Product # | Size (mm) (A) | Nut End Outside Dia. (in) (B) | Drive End Outside Dia. (in) (C) | Nut Depth (in) (D) | Bolt Clearance Depth (in) (E) | Overall Length (in) (L) | Weight (lbs) |
|-----------------|---------------|-------------------------------|---------------------------------|--------------------|-------------------------------|-------------------------|--------------|
| J4704LM | 4 | 9/32 | 29/64 | 13/64 | 55/64 | 1-63/64 | 0.04 |
| J4705LM | 5 | 5/16 | 29/64 | 9/32 | 55/64 | 1-63/64 | 0.04 |
| J47055LM | 5.5 | 11/32 | 29/64 | 9/32 | 55/64 | 1-63/64 | 0.04 |
| J4706LM | 6 | 3/8 | 29/64 | 3/8 | 55/64 | 1-63/64 | 0.04 |
| J4707LM | 7 | 27/64 | 29/64 | 3/8 | 55/64 | 1-63/64 | 0.04 |
| J4708LM | 8 | 29/64 | 29/64 | 13/32 | 1-5/32 | 1-63/64 | 0.06 |
| J4709LM | 9 | 1/2 | 1/2 | 39/64 | 1-5/32 | 1-63/64 | 0.06 |
| J4710LM | 10 | 9/16 | 9/16 | 5/8 | 1-27/64 | 1-63/64 | 0.07 |
| J4711LM | 11 | 39/64 | 39/64 | 5/8 | 1-27/64 | 1-63/64 | 0.09 |
| J4712LM | 12 | 21/32 | 21/32 | 5/8 | 1-27/64 | 1-63/64 | 0.11 |
| J4713LM | 13 | 11/16 | 11/16 | 5/8 | 1-27/64 | 1-63/64 | 0.15 |
| J4714LM | 14 | 49/64 | 49/64 | 5/8 | 1-27/64 | 1-63/64 | 0.15 |
| J4715LM | 15 | 53/64 | 53/64 | 5/8 | 1-27/64 | 2 | 0.20 |



ASME B107.5M

1/4" DRIVE SOCKETS - 8 POINT

- › Proto® 8 Point Sockets are ideal for use on stubborn or damaged fasteners, and also on fasteners made from soft materials.
- › TorquePlus™ features apply.



| Product # | Size (in) (A) | Nut End Outside Dia. (in) (B) | Drive End Outside Dia. (in) (C) | Nut Depth (in) (D) | Bolt Clearance Depth (in) (E) | Overall Length (in) (L) | Weight (lbs) |
|---------------|---------------|-------------------------------|---------------------------------|--------------------|-------------------------------|-------------------------|--------------|
| J4708S | 1/4 | 31/64 | 31/64 | 1/4 | 17/32 | 7/8 | 0.03 |
| J4710S | 5/16 | 9/16 | 9/16 | 1/4 | 17/32 | 7/8 | 0.05 |
| J4712S | 3/8 | 11/16 | 11/16 | 1/4 | 17/32 | 7/8 | 0.06 |



ASME B107.1

1/4" DRIVE SOCKETS - 12 POINT

- › Proto® 12 Point Sockets are ideal for use on stubborn or damaged fasteners, and also on fasteners made from soft materials.
- › TorquePlus™ features apply.



| Product # | Size (in) (A) | Nut End Outside Dia. (in) (B) | Drive End Outside Dia. (in) (C) | Nut Depth (in) (D) | Bolt Clearance Depth (in) (E) | Overall Length (in) (L) | Weight (lbs) |
|---------------|---------------|-------------------------------|---------------------------------|--------------------|-------------------------------|-------------------------|--------------|
| J4705T | 5/32 | 3/8 | 3/8 | 13/64 | 5/16 | 7/8 | 0.02 |
| J4706T | 3/16 | 5/16 | 7/16 | 13/64 | 5/16 | 7/8 | 0.02 |
| J4707T | 7/32 | 11/32 | 7/16 | 13/64 | 5/16 | 7/8 | 0.02 |
| J4708T | 1/4 | 3/8 | 7/16 | 7/32 | 5/16 | 7/8 | 0.02 |
| J4709T | 9/32 | 27/64 | 27/64 | 17/64 | 9/16 | 7/8 | 0.02 |
| J4710T | 5/16 | 15/32 | 15/32 | 19/64 | 9/16 | 7/8 | 0.02 |
| J4711T | 11/32 | 1/2 | 1/2 | 11/32 | 9/16 | 7/8 | 0.03 |
| J4712T | 3/8 | 35/64 | 35/64 | 23/64 | 17/32 | 7/8 | 0.04 |
| J4714T | 7/16 | 5/8 | 5/8 | 3/8 | 17/32 | 7/8 | 0.05 |
| J4716T | 1/2 | 11/16 | 11/16 | 23/64 | 17/32 | 7/8 | 0.05 |
| J4718T | 9/16 | 47/64 | 47/64 | 23/64 | 17/32 | 7/8 | 0.07 |



AS954E S3.8.1

ASME B107.1

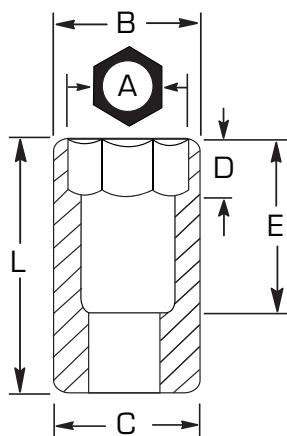

1/4" DRIVE METRIC SOCKETS - 12 POINT

METRIC

- ▶ Proto® 12 Point Sockets are ideal for use on stubborn or damaged fasteners, and also on fasteners made from soft materials.
- ▶ TorquePlus™ features apply.



| Product # | Size (mm) (A) | Nut End Outside Dia. (in) (B) | Drive End Outside Dia. (in) (C) | Nut Depth (in) (D) | Bolt Clearance Depth (in) (E) | Overall Length (in) (L) | Weight (lbs) |
|-----------|---------------|-------------------------------|---------------------------------|--------------------|-------------------------------|-------------------------|--------------|
| J4704TM | 4 | 5/16 | 15/32 | 11/64 | 1/2 | 7/8 | 0.02 |
| J47045TM | 4.5 | 5/16 | 15/32 | 11/64 | 1/2 | 7/8 | 0.02 |
| J4705TM | 5 | 5/16 | 15/32 | 11/64 | 1/2 | 7/8 | 0.03 |
| J47055TM | 5.5 | 21/64 | 15/32 | 11/64 | 1/2 | 7/8 | 0.02 |
| J4706TM | 6 | 3/8 | 15/32 | 7/32 | 1/2 | 7/8 | 0.02 |
| J4707TM | 7 | 27/64 | 15/32 | 1/4 | 9/16 | 7/8 | 0.04 |
| J4708TM | 8 | 15/32 | 15/32 | 19/64 | 35/64 | 7/8 | 0.03 |
| J4709TM | 9 | 33/64 | 33/64 | 23/64 | 35/64 | 7/8 | 0.03 |
| J4710TM | 10 | 37/64 | 37/64 | 23/64 | 35/64 | 7/8 | 0.04 |
| J4711TM | 11 | 5/8 | 5/8 | 23/64 | 35/64 | 7/8 | 0.05 |
| J4712TM | 12 | 21/32 | 21/32 | 23/64 | 35/64 | 7/8 | 0.05 |
| J4713TM | 13 | 11/16 | 11/16 | 23/64 | 35/64 | 7/8 | 0.05 |
| J4714TM | 14 | 3/4 | 3/4 | 23/64 | 9/16 | 7/8 | 0.06 |
| J4715TM | 15 | 13/16 | 13/16 | 23/64 | 17/32 | 7/8 | 0.07 |



AS954E S3.8.1

ASME B107.5M

1/4" DRIVE DEEP SOCKETS - 12 POINT

- ▶ Proto® 12 Point Sockets are ideal for use on stubborn or damaged fasteners, and also on fasteners made from soft materials.
- ▶ TorquePlus™ features apply.



| Product # | Size (in) (A) | Nut End Outside Dia. (in) (B) | Drive End Outside Dia. (in) (C) | Nut Depth (in) (D) | Bolt Clearance Depth (in) (E) | Overall Length (in) (L) | Weight (lbs) |
|-----------|---------------|-------------------------------|---------------------------------|--------------------|-------------------------------|-------------------------|--------------|
| J4706LT | 3/16 | 5/16 | 27/64 | 9/32 | 1-5/32 | 2 | 0.05 |
| J4707LT | 7/32 | 11/32 | 27/64 | 3/8 | 1-5/32 | 2 | 0.05 |
| J4708LT | 1/4 | 3/8 | 27/64 | 3/8 | 1-5/32 | 2 | 0.05 |
| J4709LT | 9/32 | 27/64 | 27/64 | 3/8 | 1-5/32 | 2 | 0.05 |
| J4710LT | 5/16 | 29/64 | 29/64 | 3/8 | 1-5/32 | 2 | 0.06 |
| J4711LT | 11/32 | 1/2 | 1/2 | 5/8 | 1-5/32 | 2 | 0.07 |
| J4712LT | 3/8 | 35/64 | 35/64 | 5/8 | 1-5/32 | 2 | 0.07 |
| J4714LT | 7/16 | 39/64 | 39/64 | 5/8 | 1-5/32 | 2 | 0.10 |
| J4716LT | 1/2 | 11/16 | 11/16 | 5/8 | 1-5/32 | 2 | 0.12 |
| J4718LT | 9/16 | 3/4 | 3/4 | 5/8 | 1-5/32 | 2 | 0.13 |



AS954E S3.8.1

ASME B107.1





1/4" DRIVE METRIC DEEP SOCKETS - 12 POINT



- › Proto® 12 Point Sockets are ideal for use on stubborn or damaged fasteners, and also on fasteners made from soft materials.
- › TorquePlus™ features apply.



| Product # | Size (mm) (A) | Nut End Outside Dia. (in) (B) | Drive End Outside Dia. (in) (C) | Nut Depth (in) (D) | Bolt Clearance Depth (in) (E) | Overall Length (in) (L) | Weight (lbs) |
|-----------|---------------|-------------------------------|---------------------------------|--------------------|-------------------------------|-------------------------|--------------|
| J4705LTM | 5 | 5/16 | 29/64 | 9/32 | 49/64 | 1-63/64 | 0.05 |
| J47055LTM | 5.5 | 11/32 | 29/64 | 9/32 | 49/64 | 1-63/64 | 0.05 |
| J4706LTM | 6 | 3/8 | 29/64 | 3/8 | 49/64 | 1-63/64 | 0.05 |
| J4707LTM | 7 | 27/64 | 29/64 | 3/8 | 49/64 | 1-63/64 | 0.07 |
| J4708LTM | 8 | 29/64 | 29/64 | 3/8 | 49/64 | 1-63/64 | 0.06 |
| J4709LTM | 9 | 1/2 | 1/2 | 5/8 | 1-7/16 | 1-63/64 | 0.06 |
| J4710LTM | 10 | 9/16 | 9/16 | 5/8 | 1-7/16 | 1-63/64 | 0.08 |
| J4711LTM | 11 | 39/64 | 39/64 | 5/8 | 1-7/16 | 1-63/64 | 0.09 |
| J4712LTM | 12 | 21/32 | 21/32 | 5/8 | 1-7/16 | 1-63/64 | 0.10 |
| J4713LTM | 13 | 11/16 | 11/16 | 5/8 | 1-7/16 | 1-63/64 | 0.11 |
| J4714LTM | 14 | 49/64 | 49/64 | 5/8 | 1-7/16 | 1-63/64 | 0.13 |
| J4715LTM | 15 | 27/32 | 27/32 | 5/8 | 1-7/16 | 1-63/64 | 0.20 |

AS954E S3.8.1 ASME B107.5M

1/4" DRIVE SOCKETS - SPLINE

- › Proto® Spline tools are designed to service high tensile strength fasteners used widely on military and commercial aircraft and in heavy machinery applications where vibration is prevalent. They are also used in automotive and industrial areas where high performance torque needs to be achieved.
- › Spline sockets help tighten high strength bolts to high torque loads. They help lower the force required to turn standard fasteners by allowing the torque load to be moved away from the corners to help prevent fastener rounding. They also turn fasteners with damaged corners.
- › Spline sockets on spline fasteners help deliver twice the torque of 12 Point wrenches on double box fasteners, and more torque than hex wrenches on hex fasteners.
- › Spline helps reduce foreign object debris (FOD) by having a precise fit between the fastening tool and its fastener.



| Product # | Size (in) (A) | Spline Size | Nut End Outside Dia. (in) (B) | Drive End Outside Dia. (in) (C) | Nut Depth (in) (D) | Bolt Clearance Depth (in) (E) | Overall Length (in) (L) | Weight (lbs) |
|-----------|---------------|-------------|-------------------------------|---------------------------------|--------------------|-------------------------------|-------------------------|--------------|
| J4706SPL | 3/16 | #6 | 5/16 | 7/16 | 3/16 | 9/16 | 59/64 | 0.02 |
| J4707SPL | 7/32 | #7 | 11/32 | 7/16 | 13/64 | 9/16 | 59/64 | 0.02 |
| J4708SPL | 1/4 | #8 | 3/8 | 7/16 | 1/4 | 9/16 | 59/64 | 0.02 |
| J4709SPL | 9/32 | #9 | 7/16 | 7/16 | 9/32 | 9/16 | 59/64 | 0.02 |
| J4710SPL | 5/16 | #10 | 29/64 | 29/64 | 5/16 | 9/16 | 59/64 | 0.03 |
| J4712SPL | 3/8 | #12 | 35/64 | 35/64 | 11/32 | 9/16 | 59/64 | 0.04 |
| J4714SPL | 7/16 | #14 | 5/8 | 5/8 | 27/64 | 11/16 | 1-1/32 | 0.05 |

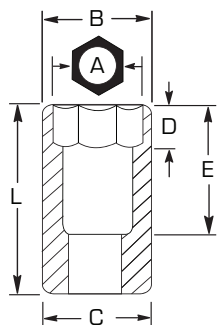



1/4" DRIVE DEEP SOCKETS - SPLINE

- › Proto® Spline tools are designed to service high tensile strength fasteners used widely on military and commercial aircraft and in heavy machinery applications where vibration is prevalent. They are also used in automotive and industrial areas where high performance torque needs to be achieved.
- › Spline sockets help tighten high strength bolts to high torque loads. They help lower the force required to turn standard fasteners by allowing the torque load to be moved away from the corners to help prevent fastener rounding. They also turn fasteners with damaged corners.
- › Spline sockets on spline fasteners help deliver twice the torque of 12 Point wrenches on double box fasteners, and more torque than hex wrenches on hex fasteners.
- › Spline helps reduce foreign object debris (FOD) by having a precise fit between the fastening tool and its fastener.



| Product # | Size (in) (A) | Spline Size | Nut End Outside Dia. (in) (B) | Drive End Outside Dia. (in) (C) | Nut Depth (in) (D) | Bolt Clearance Depth (in) (E) | Overall Length (in) (L) | Weight (lbs) |
|-----------------|---------------|-------------|-------------------------------|---------------------------------|--------------------|-------------------------------|-------------------------|--------------|
| J4706DPL | 3/16 | #6 | 5/16 | 7/16 | 3/16 | 1-21/32 | 2 | 0.03 |
| J4707DPL | 7/32 | #7 | 11/32 | 7/16 | 13/64 | 1-21/32 | 2 | 0.04 |
| J4708DPL | 1/4 | #8 | 3/8 | 7/16 | 1/4 | 1-21/32 | 2 | 0.04 |
| J4709DPL | 9/32 | #9 | 7/16 | 7/16 | 9/32 | 1-21/32 | 2 | 0.05 |
| J4710DPL | 5/16 | #10 | 29/64 | 29/64 | 5/16 | 1-21/32 | 2 | 0.06 |
| J4712DPL | 3/8 | #12 | 35/64 | 35/64 | 11/32 | 1-21/32 | 2 | 0.08 |
| J4714DPL | 7/16 | #14 | 5/8 | 5/8 | 27/64 | 1-21/32 | 2 | 0.09 |

FEATURES AND BENEFITS — SPLINE SOCKETS

- › High strength in a compact profile.
- › Standard depth and deep sockets are available in the three smaller drive sizes - 1/4", 3/8", and 1/2".
- › Can be used on spline fasteners, as well as on 4, 6, 8 or 12 point fasteners.

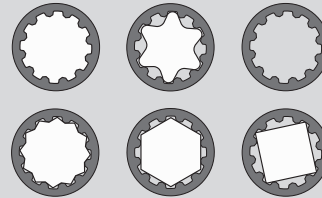

1/4" DRIVE UNIVERSAL JOINTS - 6 POINT

- › Proto® 6 Point Sockets are ideal for use on stubborn or damaged fasteners, and also on fasteners made from soft materials.
- › TorquePlus™ features apply.



| Product # | Size (in) | Nut End Outside Dia. (in) (B) | Drive End Outside Dia. (in) (C) | Nut Depth (in) (D) | Bolt Clearance Depth (in) (E) | Overall Length (in) (L) | Weight (lbs) |
|---------------|-----------|-------------------------------|---------------------------------|--------------------|-------------------------------|-------------------------|--------------|
| J4771A | 1/4 | 3/8 | 1/2 | 9/32 | 11/32 | 1-1/4 | 0.04 |
| J4772A | 5/16 | 15/32 | 1/2 | 9/32 | 11/32 | 1-1/4 | 0.04 |
| J4773A | 3/8 | 9/16 | 1/2 | 9/32 | 11/32 | 1-1/4 | 0.05 |
| J4774A | 7/16 | 5/8 | 1/2 | 9/32 | 3/8 | 1-1/4 | 0.04 |



ASME B107.1



1/4" DRIVE METRIC UNIVERSAL JOINTS - 6 POINT

METRIC

- › Proto® 6 Point Sockets are ideal for use on stubborn or damaged fasteners, and also on fasteners made from soft materials.
- › TorquePlus™ features apply.



| Product # | Size (mm) | Nut End Outside Dia. (in) (B) | Drive End Outside Dia. (in) (C) | Nut Depth (in) (D) | Bolt Clearance Depth (in) (E) | Overall Length (in) (L) | Weight (lbs) |
|-----------|-----------|-------------------------------|---------------------------------|--------------------|-------------------------------|-------------------------|--------------|
| J4805AM | 5 | 5/16 | 31/64 | 9/32 | 11/32 | 1-1/4 | 0.03 |
| J48055AM | 5.5 | 21/64 | 31/64 | 9/32 | 11/32 | 1-1/4 | 0.04 |
| J4806AM | 6 | 11/32 | 31/64 | 9/32 | 11/32 | 1-1/4 | 0.04 |
| J4807AM | 7 | 13/32 | 31/64 | 9/32 | 11/32 | 1-1/4 | 0.04 |
| J4808AM | 8 | 29/64 | 31/64 | 9/32 | 11/32 | 1-1/4 | 0.03 |
| J4809AM | 9 | 1/2 | 31/64 | 9/32 | 11/32 | 1-1/4 | 0.04 |
| J4810AM | 10 | 35/64 | 31/64 | 9/32 | 11/32 | 1-1/4 | 0.04 |
| J4811AM | 11 | 19/32 | 31/64 | 9/32 | 11/32 | 1-1/4 | 0.05 |
| J4812AM | 12 | 21/32 | 31/64 | 9/32 | 11/32 | 1-1/4 | 0.04 |
| J4813AM | 13 | 45/64 | 31/64 | 19/64 | 11/32 | 1-1/4 | 0.05 |
| J4814AM | 14 | 47/64 | 31/64 | 23/64 | 27/64 | 1-21/64 | 0.05 |
| J4815AM | 15 | 51/64 | 31/64 | 23/64 | 27/64 | 1-21/64 | 0.05 |

ASME B107.5M

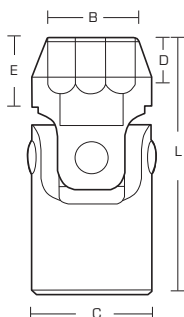

1/4" DRIVE UNIVERSAL JOINTS - 12 POINT

- › Proto® Sockets are ideal for use on stubborn or damaged fasteners, and also on fasteners made from soft materials.
- › TorquePlus™ features apply.



| Product # | Size (in) | Nut End Outside Dia. (in) (B) | Drive End Outside Dia. (in) (C) | Nut Depth (in) (D) | Bolt Clearance Depth (in) (E) | Overall Length (in) (L) | Weight (lbs) |
|-----------|-----------|-------------------------------|---------------------------------|--------------------|-------------------------------|-------------------------|--------------|
| J4770TA | 7/32 | 11/32 | 1/2 | 9/32 | 3/8 | 1-1/4 | 0.05 |
| J4771TA | 1/4 | 3/8 | 1/2 | 9/32 | 3/8 | 1-1/4 | 0.05 |
| J4777TA | 9/32 | 7/16 | 1/2 | 9/32 | 3/8 | 1-1/4 | 0.06 |
| J4772TA | 5/16 | 15/32 | 1/2 | 9/32 | 3/8 | 1-1/4 | 0.04 |
| J4778TA | 11/32 | 1/2 | 1/2 | 9/32 | 3/8 | 1-1/4 | 0.05 |
| J4773TA | 3/8 | 9/16 | 1/2 | 9/32 | 3/8 | 1-1/4 | 0.04 |
| J4774TA | 7/16 | 5/8 | 1/2 | 9/32 | 3/8 | 1-1/4 | 0.05 |
| J4775TA | 1/2 | 11/16 | 1/2 | 9/32 | 3/8 | 1-1/4 | 0.05 |
| J4776TA | 9/16 | 3/4 | 1/2 | 23/64 | 29/64 | 1-21/64 | 0.07 |

AS954E S3.8.1 ASME B107.1





1/4" DRIVE SLOTTED SCREWDRIVER BIT SOCKETS

| Product # | Tip W. (in) | Tip Thick. (in) | Overall Length (in) | Weight (lbs) |
|--------------|----------------|--------------------|------------------------|-----------------|
| J4743 | 1/4 | 3/64 | 1-13/64 | 0.05 |
| J4744 | 3/16 | 1/32 | 1-53/64 | 0.05 |
| J4745 | 1/4 | 3/64 | 1-53/64 | 0.06 |



1/4" DRIVE PHILLIPS® SCREWDRIVER BIT SOCKETS

| Product # | Tip Size | Overall Length (in) | Weight (lbs) |
|--------------|----------|------------------------|-----------------|
| J4737 | #1 | 1-13/64 | 0.04 |
| J4738 | #2 | 1-13/64 | 0.05 |



1/4" DRIVE TORX® SCREWDRIVER BIT SOCKETS

| Product # | Torx® Size | Bit Length (in) | Overall Length (in) | Weight (lbs) |
|------------------|------------|--------------------|------------------------|-----------------|
| J4739-10W | T10 | 5/8 | 1-1/2 | 0.06 |
| J4739-15W | T15 | 5/8 | 1-1/2 | 0.05 |
| J4739-20W | T20 | 5/8 | 1-1/2 | 0.05 |
| J4739-25W | T25 | 5/8 | 1-1/2 | 0.05 |
| J4739-27W | T27 | 5/8 | 1-1/2 | 0.06 |
| J4739-30W | T30 | 7/8 | 1-3/4 | 0.05 |



1/4" DRIVE HEX BIT SOCKETS

| Product # | Size (in) | Bit Length (in) | Overall Length (in) | Weight (lbs) |
|------------------|--------------|--------------------|------------------------|-----------------|
| J47701/16 | 1/16 | 1 | 1-7/8 | 0.05 |
| J47705/64 | 5/64 | 1 | 1-7/8 | 0.05 |
| J47703/32 | 3/32 | 1 | 1-7/8 | 0.05 |
| J47707/64 | 7/64 | 1 | 1-7/8 | 0.06 |
| J47701/8 | 1/8 | 1 | 1-7/8 | 0.05 |
| J47709/64 | 9/64 | 1 | 1-7/8 | 0.05 |
| J47705/32 | 5/32 | 1 | 1-7/8 | 0.05 |
| J47703/16 | 3/16 | 1 | 1-7/8 | 0.05 |
| J47707/32 | 7/32 | 1 | 1-7/8 | 0.05 |
| J47701/4 | 1/4 | 1 | 1-7/8 | 0.06 |
| J47705/16 | 5/16 | 1 | 1-7/8 | 0.06 |



1/4" DRIVE METRIC HEX BIT SOCKETS

| Product # | Size (mm) | Bit Length (in) | Overall Length (in) | Weight (lbs) |
|-------------------|--------------|--------------------|------------------------|-----------------|
| J4770-2M | 2 | 1 | 1-7/8 | 0.04 |
| J4770-2.5M | 2.5 | 1 | 1-7/8 | 0.05 |
| J4770-3M | 3 | 1 | 1-7/8 | 0.05 |
| J4770-4M | 4 | 1 | 1-7/8 | 0.05 |
| J4770-5M | 5 | 1 | 1-7/8 | 0.05 |
| J4770-6M | 6 | 1 | 1-7/8 | 0.05 |



METRIC



1/4" DRIVE BALL END HEX BIT SOCKETS

| Product # | Size (in) | Overall Length (in) | Weight (lbs) |
|------------|-----------|---------------------|--------------|
| J47701/4B | 1/4 | 1-1/2 | 0.05 |
| J47701/8B | 1/8 | 1-1/2 | 0.05 |
| J47703/16B | 3/16 | 1-1/2 | 0.05 |
| J47703/32B | 3/32 | 1-1/2 | 0.05 |
| J47705/32B | 5/32 | 1-1/2 | 0.05 |
| J47707/32B | 7/32 | 1-1/2 | 0.05 |
| J47707/64B | 7/64 | 1-1/2 | 0.05 |
| J47709/64B | 9/64 | 1-1/2 | 0.05 |



1/4" DRIVE CROWFOOT WRENCHES

- › Crowfoot wrenches are used in hard to reach, restricted access situations where a standard wrench or ratchet cannot reach.
- › Anti-Slip Design Open End (ASD).
- › The arched surfaces are designed to spread the contact forces over a greater area and they keep the loads off the corners of the fastener which helps prevent fastener rounding.
- › Broad size range ensures the right tool for the application will be available.
- › Typically used in lower torque applications.
- › Full Polish finish provides corrosion resistance and easy to clean surfaces.

| Product # | Size (in) | Overall Length (in) | Weight (lbs) |
|-----------|-----------|---------------------|--------------|
| J4708CF | 1/4 | 15/16 | 0.02 |
| J4710CF | 5/16 | 1 | 0.03 |
| J4712CF | 3/8 | 1-1/16 | 0.03 |
| J4714CF | 7/16 | 1-5/32 | 0.04 |
| J4716CF | 1/2 | 1-3/16 | 0.05 |
| J4718CF | 9/16 | 1-9/32 | 0.05 |



1/4" DRIVE METRIC CROWFOOT WRENCHES

METRIC

- › Crowfoot wrenches are used in hard to reach, restricted access situations where a standard wrench or ratchet cannot reach.
- › Anti-Slip Design Open End (ASD).
- › The arched surfaces are designed to spread the contact forces over a greater area and they keep the loads off the corners of the fastener which helps prevent fastener rounding.
- › Broad size range ensures the right tool for the application will be available.
- › Typically used in lower torque applications.
- › Full Polish finish provides corrosion resistance and easy to clean surfaces.

| Product # | Size (mm) | Overall Length (in) | Weight (lbs) |
|-----------|-----------|---------------------|--------------|
| J4707MCF | 7 | 15/16 | 0.02 |
| J4708MCF | 8 | 31/32 | 0.02 |
| J4710MCF | 10 | 1-1/16 | 0.03 |
| J4711MCF | 11 | 1-1/8 | 0.04 |
| J4712MCF | 12 | 1-5/32 | 0.04 |
| J4713MCF | 13 | 1-3/16 | 0.05 |
| J4714MCF | 14 | 1-1/4 | 0.05 |



3/8" DRIVE 58 PIECE COMBINATION SOCKET SET - 12 POINT

Product #: J52140

- ▶ 12 Point Standard: 1/4, 5/16, 3/8, 7/16, 1/2, 9/16, 5/8, 11/16, 3/4, 13/16, 7/8, 15/16, 1 Inch.
- ▶ 12 Point Deep: 1/4, 5/16, 3/8, 7/16, 1/2, 9/16, 5/8, 11/16, 3/4, 13/16, 7/8, 15/16, 1 Inch.
- ▶ 12 Point Universal: 3/8, 7/16, 1/2, 9/16, 5/8, 11/16, 3/4 Inch.
- ▶ 8 Point Standard: 1/4, 5/16, 3/8, 7/16, 1/2 Inch.
- ▶ Hex: 1/8, 1/4, 5/32, 3/16, 5/16, 7/32, 3/8 Inch.
- ▶ Phillips®: #2, 3, 4 and 1/4 Slotted.
- ▶ Accessories: Pear Head Ratchet and Adapter, 3, 6, and 12 Inch Extensions, Universal Joint, Hinge, Speed, Sliding T-Handle, and Metal Box.
- ▶ Weight (lbs): 22.67



| Contents | Description | ASME Spec. | AS Spec. |
|----------|----------------------------------|-------------|---------------|
| J5208 | Socket, 3/8" DR 1/4" 12 PT | ASME B107.1 | AS954E S3.8.1 |
| J5210 | Socket, 3/8" DR 5/16" 12 PT | ASME B107.1 | AS954E S3.8.1 |
| J5212 | Socket, 3/8" DR 3/8" 12 PT | ASME B107.1 | AS954E S3.8.1 |
| J5214 | Socket, 3/8" DR 7/16" 12 PT | ASME B107.1 | AS954E S3.8.1 |
| J5216 | Socket, 3/8" DR 1/2" 12 PT | ASME B107.1 | AS954E S3.8.1 |
| J5218 | Socket, 3/8" DR 9/16" 12 PT | ASME B107.1 | AS954E S3.8.1 |
| J5220 | Socket, 3/8" DR 5/8" 12 PT | ASME B107.1 | AS954E S3.8.1 |
| J5222 | Socket, 3/8" DR 11/16" 12 PT | ASME B107.1 | AS954E S3.8.1 |
| J5224 | Socket, 3/8" DR 3/4" 12 PT | ASME B107.1 | AS954E S3.8.1 |
| J5226 | Socket, 3/8" DR 13/16" 12 PT | ASME B107.1 | AS954E S3.8.1 |
| J5228 | Socket, 3/8" DR 7/8" 12 PT | ASME B107.1 | AS954E S3.8.1 |
| J5230 | Socket, 3/8" DR 15/16" 12 PT | ASME B107.1 | AS954E S3.8.1 |
| J5232 | Socket, 3/8" DR 1" 12 PT | ASME B107.1 | AS954E S3.8.1 |
| J5008 | Socket, 3/8" DR 1/4" 12 PT Deep | ASME B107.1 | AS954E S3.8.1 |
| J5010 | Socket, 3/8" DR 5/16" 12 PT Deep | ASME B107.1 | AS954E S3.8.1 |
| J5012 | Socket, 3/8" DR 3/8" 12 PT Deep | ASME B107.1 | AS954E S3.8.1 |
| J5014 | Socket, 3/8" DR 7/16" 12 PT Deep | ASME B107.1 | AS954E S3.8.1 |





| Contents | Description | ASME Spec. | AS Spec. |
|-----------------|---|-------------------|-----------------|
| J5016 | Socket, 3/8" DR 1/2" 12 PT Deep | ASME B107.1 | AS954E S3.8.1 |
| J5018 | Socket, 3/8" DR 9/16" 12 PT Deep | ASME B107.1 | AS954E S3.8.1 |
| J5020 | Socket, 3/8" DR 5/8" 12 PT Deep | ASME B107.1 | AS954E S3.8.1 |
| J5022 | Socket, 3/8" DR 11/16" 12 PT Deep | ASME B107.1 | AS954E S3.8.1 |
| J5024 | Socket, 3/8" DR 3/4" 12 PT Deep | ASME B107.1 | AS954E S3.8.1 |
| J5026 | Socket, 3/8" DR 13/16" 12 PT Deep | ASME B107.1 | AS954E S3.8.1 |
| J5028 | Socket, 3/8" DR 7/8" 12 PT Deep | ASME B107.1 | AS954E S3.8.1 |
| J5030 | Socket, 3/8" DR 15/16" 12 PT Deep | ASME B107.1 | AS954E S3.8.1 |
| J5032 | Socket, 3/8" DR 1" 12 PT Deep | ASME B107.1 | AS954E S3.8.1 |
| J5273 | Socket, 3/8" DR Universal 3/8" 12 PT | ASME B107.1 | AS954E S3.8.1 |
| J5274 | Socket, 3/8" DR Universal 7/16" 12 PT | ASME B107.1 | AS954E S3.8.1 |
| J5275 | Socket, 3/8" DR Universal 1/2" 12 PT | ASME B107.1 | AS954E S3.8.1 |
| J5276 | Socket, 3/8" DR Universal 9/16" 12 PT | ASME B107.1 | AS954E S3.8.1 |
| J5277 | Socket, 3/8" DR Universal 5/8" 12 PT | ASME B107.1 | AS954E S3.8.1 |
| J5278 | Socket, 3/8" DR Universal 11/16" 12 PT | ASME B107.1 | AS954E S3.8.1 |
| J5279 | Socket, 3/8" DR Universal 3/4" 12 PT | ASME B107.1 | AS954E S3.8.1 |
| J5208S | Socket, 3/8" DR 1/4" 8 PT | ASME B107.1 | |
| J5210S | Socket, 3/8" DR 5/16" 8 PT | ASME B107.1 | |
| J5212S | Socket, 3/8" DR 3/8" 8 PT | ASME B107.1 | |
| J5214S | Socket, 3/8" DR 7/16" 8 PT | ASME B107.1 | |
| J5216S | Socket, 3/8" DR 1/2" 8 PT | ASME B107.1 | |
| J5241 | Socket, Bit 3/8" DR #2 Phillips® | | |
| J49901/4 | Socket, Hex Bit 3/8" DR 1/4" | | |
| J5242 | Socket, Bit 3/8" DR #3 Phillips® | | |
| J49905/32 | Socket, Hex Bit 3/8" DR 5/32" | | |
| J5243 | Socket, Bit 3/8" DR #4 Phillips® | | |
| J49903/16 | Socket, Hex Bit 3/8" DR 3/16" | | |
| J5246 | Socket, Bit 3/8" DR Slotted | | |
| J49905/16 | Socket, Hex Bit 3/8" DR 5/16" | | |
| J5247 | Ratchet, Adapter 3/8" DR 2-1/16" | ASME B107.500 | |
| J5249 | Ratchet, 3/8" DR Standard Length Classic Pear Head 7" | ASME B107.500 | |
| J49907/32 | Socket, Hex Bit 3/8" DR 7/32" | | |
| J49901/8 | Socket, Hex Bit 3/8" DR 1/8" | | |
| J49903/8 | Socket, Hex Bit 3/8" DR 3/8" | | |
| J5260 | Extension, 3/8" DR 3" | ASME B107.500 | AS 4283 |
| J5260-06 | Extension, 3/8" DR 6" | ASME B107.500 | AS 4283 |
| J5262 | Extension, 3/8" DR 12" | ASME B107.500 | AS 4283 |
| J5265 | Handle, Hinge 3/8" DR 8-1/2" | ASME B107.500 | AS 4283 |
| J5270A | Joint, Universal 3/8" DR 2" | ASME B107.500 | |
| J5280G | Handle, Speed 3/8" DR 17-1/2" | ASME B107.500 | |
| J5285 | Handle, Sliding T 3/8" DR 8" | ASME B107.500 | |
| J9977 | General Purpose Box with Tray | | |



3/8" DRIVE 58 PIECE COMBINATION SOCKET SET - 12 POINT

Product #: J52142

- ▶ 12 Point Standard: 1/4, 5/16, 3/8, 7/16, 1/2, 9/16, 5/8, 11/16, 3/4, 13/16, 7/8, 15/16, 1 Inch.
- ▶ 12 Point Deep: 1/4, 5/16, 3/8, 7/16, 1/2, 9/16, 5/8, 11/16, 3/4, 13/16, 7/8, 15/16, 1 Inch.
- ▶ 12 Point Universal: 3/8, 7/16, 1/2, 9/16, 5/8, 11/16, 3/4 Inch.
- ▶ 8 Point Standard: 1/4, 5/16, 3/8, 7/16, 1/2 Inch.
- ▶ Hex: 1/8, 1/4, 5/32, 3/16, 5/16, 7/32, 3/8 Inch.
- ▶ Phillips® Bits #2, #3, #4, and 1/4 Slotted.
- ▶ Accessories: Pear Head Ratchet and Adapter, 3, 6, and 12 Inch Extensions, Hinge, Speed, and Sliding T-Handle, Universal Joint.
- ▶ Weight (lbs): 12.10



| Contents | Description | ASME Spec. | AS Spec. |
|-----------|--|-------------|---------------|
| J5208 | Socket, 3/8" DR 1/4" 12 PT | ASME B107.1 | AS954E S3.8.1 |
| J5210 | Socket, 3/8" DR 5/16" 12 PT | ASME B107.1 | AS954E S3.8.1 |
| J5212 | Socket, 3/8" DR 3/8" 12 PT | ASME B107.1 | AS954E S3.8.1 |
| J5214 | Socket, 3/8" DR 7/16" 12 PT | ASME B107.1 | AS954E S3.8.1 |
| J5216 | Socket, 3/8" DR 1/2" 12 PT | ASME B107.1 | AS954E S3.8.1 |
| J5218 | Socket, 3/8" DR 9/16" 12 PT | ASME B107.1 | AS954E S3.8.1 |
| J5220 | Socket, 3/8" DR 5/8" 12 PT | ASME B107.1 | AS954E S3.8.1 |
| J5222 | Socket, 3/8" DR 11/16" 12 PT | ASME B107.1 | AS954E S3.8.1 |
| J5224 | Socket, 3/8" DR 3/4" 12 PT | ASME B107.1 | AS954E S3.8.1 |
| J5226 | Socket, 3/8" DR 13/16" 12 PT | ASME B107.1 | AS954E S3.8.1 |
| J5228 | Socket, 3/8" DR 7/8" 12 PT | ASME B107.1 | AS954E S3.8.1 |
| J5230 | Socket, 3/8" DR 15/16" 12 PT | ASME B107.1 | AS954E S3.8.1 |
| J5232 | Socket, 3/8" DR 1" 12 PT | ASME B107.1 | AS954E S3.8.1 |
| J5008 | Socket, 3/8" DR 1/4" 12 PT Deep | ASME B107.1 | AS954E S3.8.1 |
| J5010 | Socket, 3/8" DR 5/16" 12 PT Deep | ASME B107.1 | AS954E S3.8.1 |
| J5012 | Socket, 3/8" DR 3/8" 12 PT Deep | ASME B107.1 | AS954E S3.8.1 |
| J5014 | Socket, 3/8" DR 7/16" 12 PT Deep | ASME B107.1 | AS954E S3.8.1 |
| J5016 | Socket, 3/8" DR 1/2" 12 PT Deep | ASME B107.1 | AS954E S3.8.1 |
| J5018 | Socket, 3/8" DR 9/16" 12 PT Deep | ASME B107.1 | AS954E S3.8.1 |
| J5020 | Socket, 3/8" DR 5/8" 12 PT Deep | ASME B107.1 | AS954E S3.8.1 |
| J5022 | Socket, 3/8" DR 11/16" 12 PT Deep | ASME B107.1 | AS954E S3.8.1 |
| J5024 | Socket, 3/8" DR 3/4" 12 PT Deep | ASME B107.1 | AS954E S3.8.1 |
| J5026 | Socket, 3/8" DR 13/16" 12 PT Deep | ASME B107.1 | AS954E S3.8.1 |
| J5028 | Socket, 3/8" DR 7/8" 12 PT Deep | ASME B107.1 | AS954E S3.8.1 |
| J5030 | Socket, 3/8" DR 15/16" 12 PT Deep | ASME B107.1 | AS954E S3.8.1 |
| J5032 | Socket, 3/8" DR 1" 12 PT Deep | ASME B107.1 | AS954E S3.8.1 |
| J5273 | Socket, 3/8" DR Universal 3/8" 12 PT | ASME B107.1 | AS954E S3.8.1 |
| J5274 | Socket, 3/8" DR Universal 7/16" 12 PT | ASME B107.1 | AS954E S3.8.1 |
| J5275 | Socket, 3/8" DR Universal 1/2" 12 PT | ASME B107.1 | AS954E S3.8.1 |
| J5276 | Socket, 3/8" DR Universal 9/16" 12 PT | ASME B107.1 | AS954E S3.8.1 |
| J5277 | Socket, 3/8" DR Universal 5/8" 12 PT | ASME B107.1 | AS954E S3.8.1 |
| J5278 | Socket, 3/8" DR Universal 11/16" 12 PT | ASME B107.1 | AS954E S3.8.1 |
| J5279 | Socket, 3/8" DR Universal 3/4" 12 PT | ASME B107.1 | AS954E S3.8.1 |
| J5208S | Socket, 3/8" DR 1/4" 8 PT | ASME B107.1 | |
| J5210S | Socket, 3/8" DR 5/16" 8 PT | ASME B107.1 | |
| J5212S | Socket, 3/8" DR 3/8" 8 PT | ASME B107.1 | |
| J5214S | Socket, 3/8" DR 7/16" 8 PT | ASME B107.1 | |
| J5216S | Socket, 3/8" DR 1/2" 8 PT | ASME B107.1 | |
| J49901/8 | Socket, Hex Bit 3/8" DR 1/8" | | |
| J49901/4 | Socket, Hex Bit 3/8" DR 1/4" | | |
| J49905/32 | Socket, Hex Bit 3/8" DR 5/32" | | |
| J49903/16 | Socket, Hex Bit 3/8" DR 3/16" | | |
| J49905/16 | Socket, Hex Bit 3/8" DR 5/16" | | |
| J49907/32 | Socket, Hex Bit 3/8" DR 7/32" | | |
| J49903/8 | Socket, Hex Bit 3/8" DR 3/8" | | |
| J5242 | Socket, Bit 3/8" DR #3 Phillips® | | |



| Contents | Description | ASME Spec. | AS Spec. |
|----------|---|---------------|----------|
| J5241 | Socket, Bit 3/8" DR #2 Phillips® | | |
| J5243 | Socket, Bit 3/8" DR #4 Phillips® | | |
| J5246 | Socket, Bit 3/8" DR Slotted | | |
| J5247 | Ratchet, Adapter 3/8" DR 2-1/16" | ASME B107.500 | |
| J5249 | Ratchet, 3/8" DR Standard Length Classic Pear Head 7" | ASME B107.500 | |
| J5260 | Extension, 3/8" DR 3" | ASME B107.500 | AS 4283 |
| J5260-06 | Extension, 3/8" DR 6" | ASME B107.500 | AS 4283 |
| J5262 | Extension, 3/8" DR 12" | ASME B107.500 | AS 4283 |
| J5265 | Handle, Hinge 3/8" DR 8-1/2" | ASME B107.500 | AS 4283 |
| J5270A | Joint, Universal 3/8" DR 2" | ASME B107.500 | |
| J5285 | Handle, Sliding T 3/8" DR 8" | ASME B107.500 | |
| J5280G | Handle, Speed 3/8" DR 17-1/2" | ASME B107.500 | AS4283 |

3/8" DRIVE 33 PIECE COMBINATION SOCKET SET - 12 AND 8 POINT

Product #: J52138

- › 8 Point Standard: 1/4, 5/16, 3/8 Inch.
- › 12 Point Standard: 3/8, 7/16, 1/2, 9/16, 5/8, 11/16, 3/4, 13/16, 7/8 Inch.
- › 12 Point Deep: 3/8, 7/16, 1/2, 9/16, 5/8, 11/16, 3/4, 13/16, 7/8 Inch.
- › 12 Point Universal: 7/16, 1/2, 9/16, 5/8, 3/4 Inch.
- › Accessories: Pear Head Ratchet, 3, 6, and 12 Inch Extensions, 7-7/8 Inch Hinge Handle, Universal Joint, Speed Handle, and Blow-Molded Case.
- › Weight (lbs): 12.68



| Contents | Description | ASME Spec. | AS Spec. |
|----------|---|---------------|---------------|
| J5212 | Socket, 3/8" DR 3/8" 12 PT | ASME B107.1 | AS954E S3.8.1 |
| J5214 | Socket, 3/8" DR 7/16" 12 PT | ASME B107.1 | AS954E S3.8.1 |
| J5216 | Socket, 3/8" DR 1/2" 12 PT | ASME B107.1 | AS954E S3.8.1 |
| J5218 | Socket, 3/8" DR 9/16" 12 PT | ASME B107.1 | AS954E S3.8.1 |
| J5220 | Socket, 3/8" DR 5/8" 12 PT | ASME B107.1 | AS954E S3.8.1 |
| J5222 | Socket, 3/8" DR 11/16" 12 PT | ASME B107.1 | AS954E S3.8.1 |
| J5224 | Socket, 3/8" DR 3/4" 12 PT | ASME B107.1 | AS954E S3.8.1 |
| J5226 | Socket, 3/8" DR 13/16" 12 PT | ASME B107.1 | AS954E S3.8.1 |
| J5228 | Socket, 3/8" DR 7/8" 12 PT | ASME B107.1 | AS954E S3.8.1 |
| J5012 | Socket, 3/8" DR 3/8" 12 PT Deep | ASME B107.1 | AS954E S3.8.1 |
| J5014 | Socket, 3/8" DR 7/16" 12 PT Deep | ASME B107.1 | AS954E S3.8.1 |
| J5016 | Socket, 3/8" DR 1/2" 12 PT Deep | ASME B107.1 | AS954E S3.8.1 |
| J5018 | Socket, 3/8" DR 9/16" 12 PT Deep | ASME B107.1 | AS954E S3.8.1 |
| J5020 | Socket, 3/8" DR 5/8" 12 PT Deep | ASME B107.1 | AS954E S3.8.1 |
| J5022 | Socket, 3/8" DR 11/16" 12 PT Deep | ASME B107.1 | AS954E S3.8.1 |
| J5024 | Socket, 3/8" DR 3/4" 12 PT Deep | ASME B107.1 | AS954E S3.8.1 |
| J5026 | Socket, 3/8" DR 13/16" 12 PT Deep | ASME B107.1 | AS954E S3.8.1 |
| J5028 | Socket, 3/8" DR 7/8" 12 PT Deep | ASME B107.1 | AS954E S3.8.1 |
| J5208S | Socket, 3/8" DR 1/4" 8 PT | ASME B107.1 | |
| J5210S | Socket, 3/8" DR 5/16" 8 PT | ASME B107.1 | |
| J5212S | Socket, 3/8" DR 3/8" 8 PT | ASME B107.1 | |
| J5274 | Socket, 3/8" DR Universal 7/16" 12 PT | ASME B107.1 | AS954E S3.8.1 |
| J5275 | Socket, 3/8" DR Universal 1/2" 12 PT | ASME B107.1 | AS954E S3.8.1 |
| J5276 | Socket, 3/8" DR Universal 9/16" 12 PT | ASME B107.1 | AS954E S3.8.1 |
| J5277 | Socket, 3/8" DR Universal 5/8" 12 PT | ASME B107.1 | AS954E S3.8.1 |
| J5279 | Socket, 3/8" DR Universal 3/4" 12 PT | ASME B107.1 | AS954E S3.8.1 |
| J5249 | Ratchet, 3/8" DR Standard Length Classic Pear Head 7" | ASME B107.500 | |
| J5260 | Extension, 3/8" DR 3" | ASME B107.500 | AS 4283 |
| J5260-06 | Extension, 3/8" DR 6" | ASME B107.500 | AS 4283 |
| J5262 | Extension, 3/8" DR 12" | ASME B107.500 | AS 4283 |
| J5265 | Handle, Hinge 3/8" DR 8-1/2" | ASME B107.500 | AS 4283 |
| J5270A | Joint, Universal 3/8" DR 2" | ASME B107.500 | |
| J5280G | Handle, Speed 3/8" DR 17-1/2" | ASME B107.500 | |
| JBM1104 | Blow-Molded Case | | |



3/8" DRIVE 33 PIECE COMBINATION SOCKET SET - 12 AND 8 POINT

Product #: **J52138XL**

- ▶ 12 Point Standard: 3/8, 7/16, 1/2, 9/16, 5/8, 11/16, 3/4, 13/16, 7/8 Inch.
- ▶ 12 Point Deep: 3/8, 7/16, 1/2, 9/16, 5/8, 11/16, 3/4, 13/16, 7/8 Inch.
- ▶ 8 Point Standard: 7/16, 1/2, 9/16, 5/8, 3/4 Inch.
- ▶ Accessories: Premium Ratchet, 3 and 12 Inch Extensions, Hinge handle, Universal Joint, Speed Handle, and Blow-Molded Case.
- ▶ Weight (lbs): 13.27



| Contents | Description | ASME Spec. | AS Spec. |
|----------|---|---------------|---------------|
| J5012 | Socket, 3/8" DR 3/8" 12 PT Deep | | |
| J5014 | Socket, 3/8" DR 7/16" 12 PT Deep | ASME B107.1 | AS954E S3.8.1 |
| J5016 | Socket, 3/8" DR 1/2" 12 PT Deep | | |
| J5018 | Socket, 3/8" DR 9/16" 12 PT Deep | | |
| J5020 | Socket, 3/8" DR 5/8" 12 PT Deep | ASME B107.1 | AS954E S3.8.1 |
| J5022 | Socket, 3/8" DR 11/16" 12 PT Deep | | |
| J5024 | Socket, 3/8" DR 3/4" 12 PT Deep | ASME B107.1 | AS954E S3.8.1 |
| J5026 | Socket, 3/8" DR 13/16" 12 PT Deep | ASME B107.1 | AS954E S3.8.1 |
| J5028 | Socket, 3/8" DR 7/8" 12 PT Deep | ASME B107.1 | AS954E S3.8.1 |
| J5208S | Socket, 3/8" DR 1/4" 8 PT | ASME B107.1 | |
| J5210S | Socket, 3/8" DR 5/16" 8 PT | ASME B107.1 | |
| J5212 | Socket, 3/8" DR 3/8" 12 PT | ASME B107.1 | AS954E S3.8.1 |
| J5212S | Socket, 3/8" DR 3/8" 8 PT | ASME B107.1 | |
| J5214 | Socket, 3/8" DR 7/16" 12 PT | ASME B107.1 | AS954E S3.8.1 |
| J5216 | Socket, 3/8" DR 1/2" 12 PT | ASME B107.1 | AS954E S3.8.1 |
| J5218 | Socket, 3/8" DR 9/16" 12 PT | ASME B107.1 | AS954E S3.8.1 |
| J5220 | Socket, 3/8" DR 5/8" 12 PT | ASME B107.1 | AS954E S3.8.1 |
| J5222 | Socket, 3/8" DR 11/16" 12 PT | ASME B107.1 | AS954E S3.8.1 |
| J5224 | Socket, 3/8" DR 3/4" 12 PT | ASME B107.1 | AS954E S3.8.1 |
| J5226 | Socket, 3/8" DR 13/16" 12 PT | ASME B107.1 | AS954E S3.8.1 |
| J5228 | Socket, 3/8" DR 7/8" 12 PT | ASME B107.1 | AS954E S3.8.1 |
| J5249XL | Ratchet, 3/8" DR Standard Length Premium Pear Head 8-1/2" | ASME B107.500 | |
| J5260 | Extension, 3/8" DR 3" | ASME B107.500 | AS 4283 |
| J5260-06 | Extension, 3/8" DR 6" | ASME B107.500 | AS 4283 |
| J5262 | Extension, 3/8" DR 12" | ASME B107.500 | AS 4283 |
| J5265 | Handle, Hinge 3/8" DR 8-1/2" | ASME B107.500 | AS 4283 |
| J5270A | Joint, Universal 3/8" DR 2" | ASME B107.500 | |
| J5274A | Socket, 3/8" DR Universal 7/16" 12 PT | ASME B107.1 | AS954E S3.8.1 |
| J5275A | Socket, 3/8" DR Universal 1/2" 12 PT | ASME B107.1 | AS954E S3.8.1 |
| J5276A | Socket, 3/8" DR Universal 9/16" 12 PT | ASME B107.1 | AS954E S3.8.1 |
| J5277A | Socket, 3/8" DR Universal 5/8" 12 PT | ASME B107.1 | AS954E S3.8.1 |
| J5279A | Socket, 3/8" DR Universal 3/4" 12 PT | ASME B107.1 | AS954E S3.8.1 |
| J5280G | Handle, Speed 3/8" DR 17-1/2" | ASME B107.500 | |
| JBM1104 | Blow-Molded Case | | |



3/8" DRIVE 29 PIECE METRIC COMBINATION SOCKET SET - 6 POINT

METRIC

Product #: J52220

- › 6 Point Standard: 8, 9, 10, 11, 12, 13, 14, 15, 16, 17, 18, 19 mm.
- › 6 Point Deep: 8, 9, 10, 11, 12, 13, 14, 15, 16, 17, 18, 19 mm.
- › Accessories: Pear Head Ratchet, 3 and 6 Inch Extensions, Hinge Handle, Universal Joint, and Blow-Molded Case.
- › Weight (lbs): 9.18



| Contents | Description | ASME Spec. | AS Spec. |
|----------|---|---------------|----------|
| J5208MH | Socket, 3/8" DR 8 mm 6 PT | ASME B107.5M | |
| J5209MH | Socket, 3/8" DR 9 mm 6 PT | ASME B107.5M | |
| J5210MH | Socket, 3/8" DR 10 mm 6 PT | ASME B107.5M | |
| J5211MH | Socket, 3/8" DR 11 mm 6 PT | ASME B107.5M | |
| J5212MH | Socket, 3/8" DR 12 mm 6 PT | ASME B107.5M | |
| J5213MH | Socket, 3/8" DR 13 mm 6 PT | ASME B107.5M | |
| J5214MH | Socket, 3/8" DR 14 mm 6 PT | ASME B107.5M | |
| J5215MH | Socket, 3/8" DR 15 mm 6 PT | ASME B107.5M | |
| J5216MH | Socket, 3/8" DR 16 mm 6 PT | ASME B107.5M | |
| J5217MH | Socket, 3/8" DR 17 mm 6 PT | ASME B107.5M | |
| J5218MH | Socket, 3/8" DR 18 mm 6 PT | ASME B107.5M | |
| J5219MH | Socket, 3/8" DR 19 mm 6 PT | ASME B107.5M | |
| J5008MH | Socket, 3/8" DR 8 mm 6 PT Deep | ASME B107.5M | |
| J5009MH | Socket, 3/8" DR 9 mm 6 PT Deep | ASME B107.5M | |
| J5010MH | Socket, 3/8" DR 10 mm 6 PT Deep | ASME B107.5M | |
| J5011MH | Socket, 3/8" DR 11 mm 6 PT Deep | ASME B107.5M | |
| J5012MH | Socket, 3/8" DR 12 mm 6 PT Deep | ASME B107.5M | |
| J5013MH | Socket, 3/8" DR 13 mm 6 PT Deep | ASME B107.5M | |
| J5014MH | Socket, 3/8" DR 14 mm 6 PT Deep | ASME B107.5M | |
| J5015MH | Socket, 3/8" DR 15 mm 6 PT Deep | ASME B107.5M | |
| J5016MH | Socket, 3/8" DR 16 mm 6 PT Deep | ASME B107.5M | |
| J5017MH | Socket, 3/8" DR 17 mm 6 PT Deep | ASME B107.5M | |
| J5018MH | Socket, 3/8" DR 18 mm 6 PT Deep | ASME B107.5M | |
| J5019MH | Socket, 3/8" DR 19 mm 6 PT Deep | ASME B107.5M | |
| J5249 | Ratchet, 3/8" DR Standard Length Classic Pear Head 7" | ASME B107.500 | |
| J5260 | Extension, 3/8" DR 3" | ASME B107.500 | AS 4283 |
| J5260-06 | Extension, 3/8" DR 6" | ASME B107.500 | AS 4283 |
| J5265 | Handle, Hinge 3/8" DR 8-1/2" | ASME B107.500 | AS 4283 |
| J5270A | Joint, Universal 3/8" DR 2" | ASME B107.500 | |
| JBM1106 | Blow-Molded Case | | |



3/8" DRIVE 29 PIECE METRIC COMBINATION SOCKET SET - 6 POINT

METRIC

Product #: J5220XL



- › 6 Point Standard: 8, 9, 10, 11, 12, 13, 14, 15, 16, 17, 18, 19 mm.
- › 6 Point Deep: 8, 9, 10, 11, 12, 13, 14, 15, 16, 17, 18, 19 mm.
- › Accessories: Premium Ratchet, 3 and 6 Inch Extensions, Universal Joint, Hinge Handle, and Blow-Molded Case.
- › Weight (lbs): 9.51



| Contents | Description | ASME Spec. | AS Spec. |
|----------|---|---------------|----------|
| J5008MH | Socket, 3/8" DR 8 mm 6 PT Deep | ASME B107.5M | |
| J5009MH | Socket, 3/8" DR 9 mm 6 PT Deep | ASME B107.5M | |
| J5010MH | Socket, 3/8" DR 10 mm 6 PT Deep | ASME B107.5M | |
| J5011MH | Socket, 3/8" DR 11 mm 6 PT Deep | ASME B107.5M | |
| J5012MH | Socket, 3/8" DR 12 mm 6 PT Deep | ASME B107.5M | |
| J5013MH | Socket, 3/8" DR 13 mm 6 PT Deep | ASME B107.5M | |
| J5014MH | Socket, 3/8" DR 14 mm 6 PT Deep | ASME B107.5M | |
| J5015MH | Socket, 3/8" DR 15 mm 6 PT Deep | ASME B107.5M | |
| J5016MH | Socket, 3/8" DR 16 mm 6 PT Deep | ASME B107.5M | |
| J5017MH | Socket, 3/8" DR 17 mm 6 PT Deep | ASME B107.5M | |
| J5018MH | Socket, 3/8" DR 18 mm 6 PT Deep | ASME B107.5M | |
| J5019MH | Socket, 3/8" DR 19 mm 6 PT Deep | ASME B107.5M | |
| J5208MH | Socket, 3/8" DR 8 mm 6 PT | ASME B107.5M | |
| J5209MH | Socket, 3/8" DR 9 mm 6 PT | ASME B107.5M | |
| J5210MH | Socket, 3/8" DR 10 mm 6 PT | ASME B107.5M | |
| J5211MH | Socket, 3/8" DR 11 mm 6 PT | ASME B107.5M | |
| J5212MH | Socket, 3/8" DR 12 mm 6 PT | ASME B107.5M | |
| J5213MH | Socket, 3/8" DR 13 mm 6 PT | ASME B107.5M | |
| J5214MH | Socket, 3/8" DR 14 mm 6 PT | ASME B107.5M | |
| J5215MH | Socket, 3/8" DR 15 mm 6 PT | ASME B107.5M | |
| J5216MH | Socket, 3/8" DR 16 mm 6 PT | ASME B107.5M | |
| J5217MH | Socket, 3/8" DR 17 mm 6 PT | ASME B107.5M | |
| J5218MH | Socket, 3/8" DR 18 mm 6 PT | ASME B107.5M | |
| J5219MH | Socket, 3/8" DR 19 mm 6 PT | ASME B107.5M | |
| J5249XL | Ratchet, 3/8" DR Standard Length Premium Pear Head 8-1/2" | ASME B107.500 | |
| J5260 | Extension, 3/8" DR 3" | ASME B107.500 | AS 4283 |
| J5260-06 | Extension, 3/8" DR 6" | ASME B107.500 | AS 4283 |
| J5265 | Handle, Hinge 3/8" DR 8-1/2" | ASME B107.500 | AS 4283 |
| J5270A | Joint, Universal 3/8" DR 2" | ASME B107.500 | |
| JBM1106 | Blow-Molded Case | | |



3/8" DRIVE 29 PIECE METRIC COMBINATION SOCKET SET - 12 POINT

METRIC

Product #: J52222

- › 12 Point Standard: 8, 9, 10, 11, 12, 13, 14, 15, 16, 17, 18, 19 mm.
- › 12 Point Deep: 8, 9, 10, 11, 12, 13, 14, 15, 16, 17, 18, 19 mm.
- › Accessories: Pear Head Ratchet, 3 and 6 Inch Extensions, Hinge Handle, Universal Joint, and Blow-Molded Case.
- › Weight (lbs): 9.14



| Contents | Description | ASME Spec. | AS Spec. |
|----------|---|---------------|---------------|
| J5208M | Socket, 3/8" DR 8 mm 12 PT | ASME B107.5M | AS954E S3.8.1 |
| J5209M | Socket, 3/8" DR 9 mm 12 PT | ASME B107.5M | AS954E S3.8.1 |
| J5210M | Socket, 3/8" DR 10 mm 12 PT | ASME B107.5M | AS954E S3.8.1 |
| J5211M | Socket, 3/8" DR 11 mm 12 PT | ASME B107.5M | AS954E S3.8.1 |
| J5212M | Socket, 3/8" DR 12 mm 12 PT | ASME B107.5M | AS954E S3.8.1 |
| J5213M | Socket, 3/8" DR 13 mm 12 PT | ASME B107.5M | AS954E S3.8.1 |
| J5214M | Socket, 3/8" DR 14 mm 12 PT | ASME B107.5M | AS954E S3.8.1 |
| J5215M | Socket, 3/8" DR 15 mm 12 PT | ASME B107.5M | AS954E S3.8.1 |
| J5216M | Socket, 3/8" DR 16 mm 12 PT | ASME B107.5M | AS954E S3.8.1 |
| J5217M | Socket, 3/8" DR 17 mm 12 PT | ASME B107.5M | AS954E S3.8.1 |
| J5218M | Socket, 3/8" DR 18 mm 12 PT | ASME B107.5M | AS954E S3.8.1 |
| J5219M | Socket, 3/8" DR 19 mm 12 PT | ASME B107.5M | AS954E S3.8.1 |
| J5008M | Socket, 3/8" DR 8 mm 12 PT Deep | ASME B107.5M | AS954E S3.8.1 |
| J5009M | Socket, 3/8" DR 9 mm 12 PT Deep | ASME B107.5M | AS954E S3.8.1 |
| J5010M | Socket, 3/8" DR 10 mm 12 PT Deep | ASME B107.5M | AS954E S3.8.1 |
| J5011M | Socket, 3/8" DR 11 mm 12 PT Deep | ASME B107.5M | AS954E S3.8.1 |
| J5012M | Socket, 3/8" DR 12 mm 12 PT Deep | ASME B107.5M | AS954E S3.8.1 |
| J5013M | Socket, 3/8" DR 13 mm 12 PT Deep | ASME B107.5M | AS954E S3.8.1 |
| J5014M | Socket, 3/8" DR 14 mm 12 PT Deep | ASME B107.5M | AS954E S3.8.1 |
| J5015M | Socket, 3/8" DR 15 mm 12 PT Deep | ASME B107.5M | AS954E S3.8.1 |
| J5016M | Socket, 3/8" DR 16 mm 12 PT Deep | ASME B107.5M | AS954E S3.8.1 |
| J5017M | Socket, 3/8" DR 17 mm 12 PT Deep | ASME B107.5M | AS954E S3.8.1 |
| J5018M | Socket, 3/8" DR 18 mm 12 PT Deep | ASME B107.5M | AS954E S3.8.1 |
| J5019M | Socket, 3/8" DR 19 mm 12 PT Deep | ASME B107.5M | AS954E S3.8.1 |
| J5249 | Ratchet, 3/8" DR Standard Length Classic Pear Head 7" | ASME B107.500 | |
| J5260 | Extension, 3/8" DR 3" | ASME B107.500 | AS 4283 |
| J5260-06 | Extension, 3/8" DR 6" | ASME B107.500 | AS 4283 |
| J5265 | Handle, Hinge 3/8" DR 8-1/2" | ASME B107.500 | AS 4283 |
| J5270A | Joint, Universal 3/8" DR 2" | ASME B107.500 | |
| JBM1106 | Blow-Molded Case | | |



3/8" DRIVE 29 PIECE METRIC COMBINATION SOCKET SET - 12 POINT

METRIC

Product #: J5222XL



- ▶ 12 Point Standard: 8, 9, 10, 11, 12, 13, 14, 15, 16, 17, 18, 19 mm.
- ▶ 12 Point Deep: 8, 9, 10, 11, 12, 13, 14, 15, 16, 17, 18, 19 mm.
- ▶ Accessories: Premium Ratchet, 3 and 6 Inch Extensions, Universal Joint, Hinge Handle, and Blow-Molded Case.
- ▶ Weight (lbs): 9.36



| Contents | Description | ASME Spec. | AS Spec. |
|----------|---|---------------|---------------|
| J5008M | Socket, 3/8" DR 8 mm 12 PT Deep | ASME B107.5M | AS954E S3.8.1 |
| J5009M | Socket, 3/8" DR 9 mm 12 PT Deep | ASME B107.5M | AS954E S3.8.1 |
| J5010M | Socket, 3/8" DR 10 mm 12 PT Deep | ASME B107.5M | AS954E S3.8.1 |
| J5011M | Socket, 3/8" DR 11 mm 12 PT Deep | ASME B107.5M | AS954E S3.8.1 |
| J5012M | Socket, 3/8" DR 12 mm 12 PT Deep | ASME B107.5M | AS954E S3.8.1 |
| J5013M | Socket, 3/8" DR 13 mm 12 PT Deep | ASME B107.5M | AS954E S3.8.1 |
| J5014M | Socket, 3/8" DR 14 mm 12 PT Deep | ASME B107.5M | AS954E S3.8.1 |
| J5015M | Socket, 3/8" DR 15 mm 12 PT Deep | ASME B107.5M | AS954E S3.8.1 |
| J5016M | Socket, 3/8" DR 16 mm 12 PT Deep | ASME B107.5M | AS954E S3.8.1 |
| J5017M | Socket, 3/8" DR 17 mm 12 PT Deep | ASME B107.5M | AS954E S3.8.1 |
| J5018M | Socket, 3/8" DR 18 mm 12 PT Deep | ASME B107.5M | AS954E S3.8.1 |
| J5019M | Socket, 3/8" DR 19 mm 12 PT Deep | ASME B107.5M | AS954E S3.8.1 |
| J5208M | Socket, 3/8" DR 8 mm 12 PT | ASME B107.5M | AS954E S3.8.1 |
| J5209M | Socket, 3/8" DR 9 mm 12 PT | ASME B107.5M | AS954E S3.8.1 |
| J5210M | Socket, 3/8" DR 10 mm 12 PT | ASME B107.5M | AS954E S3.8.1 |
| J5211M | Socket, 3/8" DR 11 mm 12 PT | ASME B107.5M | AS954E S3.8.1 |
| J5212M | Socket, 3/8" DR 12 mm 12 PT | ASME B107.5M | AS954E S3.8.1 |
| J5213M | Socket, 3/8" DR 13 mm 12 PT | ASME B107.5M | AS954E S3.8.1 |
| J5214M | Socket, 3/8" DR 14 mm 12 PT | ASME B107.5M | AS954E S3.8.1 |
| J5215M | Socket, 3/8" DR 15 mm 12 PT | ASME B107.5M | AS954E S3.8.1 |
| J5216M | Socket, 3/8" DR 16 mm 12 PT | ASME B107.5M | AS954E S3.8.1 |
| J5217M | Socket, 3/8" DR 17 mm 12 PT | ASME B107.5M | AS954E S3.8.1 |
| J5218M | Socket, 3/8" DR 18 mm 12 PT | ASME B107.5M | AS954E S3.8.1 |
| J5219M | Socket, 3/8" DR 19 mm 12 PT | ASME B107.5M | AS954E S3.8.1 |
| J5249XL | Ratchet, 3/8" DR Standard Length Premium Pear Head 8-1/2" | ASME B107.500 | |
| J5260 | Extension, 3/8" DR 3" | ASME B107.500 | AS 4283 |
| J5260-06 | Extension, 3/8" DR 6" | ASME B107.500 | AS 4283 |
| J5265 | Handle, Hinge 3/8" DR 8-1/2" | ASME B107.500 | AS 4283 |
| J5270A | Joint, Universal 3/8" DR 2" | ASME B107.500 | |
| JBM1106 | Blow-Molded Case | | |





3/8" DRIVE 20 PIECE METRIC SOCKET SET - 12 POINT



Product #: J52224

- › 12 Point Standard: 6, 7, 8, 9, 10, 11, 12, 13, 14, 15, 16, 17, 18, 19 mm.
- › Accessories: Ratchet, 3 and 12 Inch Extensions, Hinge Handle, Universal Joint, Speed Handle, and Blow-Molded Case.
- › Weight (lbs): 7.97



| Contents | Description | ASME Spec. | AS Spec. |
|----------|---|---------------|---------------|
| J5206M | Socket, 3/8" DR 6 mm 12 PT | ASME B107.5M | AS954E S3.8.1 |
| J5207M | Socket, 3/8" DR 7 mm 12 PT | ASME B107.5M | AS954E S3.8.1 |
| J5208M | Socket, 3/8" DR 8 mm 12 PT | ASME B107.5M | AS954E S3.8.1 |
| J5209M | Socket, 3/8" DR 9 mm 12 PT | ASME B107.5M | AS954E S3.8.1 |
| J5210M | Socket, 3/8" DR 10 mm 12 PT | ASME B107.5M | AS954E S3.8.1 |
| J5211M | Socket, 3/8" DR 11 mm 12 PT | ASME B107.5M | AS954E S3.8.1 |
| J5212M | Socket, 3/8" DR 12 mm 12 PT | ASME B107.5M | AS954E S3.8.1 |
| J5213M | Socket, 3/8" DR 13 mm 12 PT | ASME B107.5M | AS954E S3.8.1 |
| J5214M | Socket, 3/8" DR 14 mm 12 PT | ASME B107.5M | AS954E S3.8.1 |
| J5215M | Socket, 3/8" DR 15 mm 12 PT | ASME B107.5M | AS954E S3.8.1 |
| J5216M | Socket, 3/8" DR 16 mm 12 PT | ASME B107.5M | AS954E S3.8.1 |
| J5217M | Socket, 3/8" DR 17 mm 12 PT | ASME B107.5M | AS954E S3.8.1 |
| J5218M | Socket, 3/8" DR 18 mm 12 PT | ASME B107.5M | AS954E S3.8.1 |
| J5219M | Socket, 3/8" DR 19 mm 12 PT | ASME B107.5M | AS954E S3.8.1 |
| J5249 | Ratchet, 3/8" DR Standard Length Classic Pear Head 7" | ASME B107.500 | |
| J5260 | Extension, 3/8" DR 3" | ASME B107.500 | AS 4283 |
| J5262 | Extension, 3/8" DR 12" | ASME B107.500 | AS 4283 |
| J5265 | Handle, Hinge 3/8" DR 8-1/2" | ASME B107.500 | AS 4283 |
| J5270A | Universal Joint, 3/8" DR 2" | ASME B107.500 | |
| J5280G | Handle, Speed 3/8" DR 17-1/2" | ASME B107.500 | |
| JBM1104 | Blow-Molded Case | | |

3/8" DRIVE 20 PIECE METRIC SOCKET SET - 12 POINT



Product #: J52224XL

- › 12 Point Standard: 6, 7, 8, 9, 10, 11, 12, 13, 14, 15, 16, 17, 18, 19 mm.
- › Accessories: Premium Ratchet, 3 and 12 Inch Extensions, Hinge handle, Universal Joint, Speed Handle, and Blow-Molded Case.
- › Weight (lbs): 8.39



| Contents | Description | ASME Spec. | AS Spec. |
|----------|---|---------------|---------------|
| J5206M | Socket, 3/8" DR 6 mm 12 PT | ASME B107.5M | AS954E S3.8.1 |
| J5207M | Socket, 3/8" DR 7 mm 12 PT | ASME B107.5M | AS954E S3.8.1 |
| J5208M | Socket, 3/8" DR 8 mm 12 PT | ASME B107.5M | AS954E S3.8.1 |
| J5209M | Socket, 3/8" DR 9 mm 12 PT | ASME B107.5M | AS954E S3.8.1 |
| J5210M | Socket, 3/8" DR 10 mm 12 PT | ASME B107.5M | AS954E S3.8.1 |
| J5211M | Socket, 3/8" DR 11 mm 12 PT | ASME B107.5M | AS954E S3.8.1 |
| J5212M | Socket, 3/8" DR 12 mm 12 PT | ASME B107.5M | AS954E S3.8.1 |
| J5213M | Socket, 3/8" DR 13 mm 12 PT | ASME B107.5M | AS954E S3.8.1 |
| J5214M | Socket, 3/8" DR 14 mm 12 PT | ASME B107.5M | AS954E S3.8.1 |
| J5215M | Socket, 3/8" DR 15 mm 12 PT | ASME B107.5M | AS954E S3.8.1 |
| J5216M | Socket, 3/8" DR 16 mm 12 PT | ASME B107.5M | AS954E S3.8.1 |
| J5217M | Socket, 3/8" DR 17 mm 12 PT | ASME B107.5M | AS954E S3.8.1 |
| J5218M | Socket, 3/8" DR 18 mm 12 PT | ASME B107.5M | AS954E S3.8.1 |
| J5219M | Socket, 3/8" DR 19 mm 12 PT | ASME B107.5M | AS954E S3.8.1 |
| J5249XL | Ratchet, 3/8" DR Standard Length Premium Pear Head 8-1/2" | ASME B107.500 | |
| J5260 | Extension, 3/8" DR 3" | ASME B107.500 | AS 4283 |
| J5262 | Extension, 3/8" DR 12" | ASME B107.500 | AS 4283 |
| J5265 | Handle, Hinge 3/8" DR 8-1/2" | ASME B107.500 | AS 4283 |
| J5270A | Joint, Universal 3/8" DR 2" | ASME B107.500 | |
| J5280G | Handle, Speed 3/8" DR 17-1/2" | ASME B107.500 | |
| JBM1107 | Blow-Molded Case | | |



3/8" DRIVE 57 PIECE METRIC SOCKET SET - 12 POINT

METRIC

Product #: J52226

- › 12 Point Standard: 6, 7, 8, 9, 10, 11, 12, 13, 14, 15, 17, 18, 19, 20, 21, 22 mm.
- › 12 Point Deep: 6, 7, 8, 9, 10, 11, 12, 13, 14, 15, 17, 18, 19 mm.
- › 12 Point Universal: 9, 10, 11, 12, 13, 14, 15 mm.
- › Hex: 4, 5, 6, 7, 8, 10 mm.
- › Bits: #2, 3, 4 Phillips®, 1/4 Inch Slotted.
- › Accessories: Pear Head Ratchet and Adapter, 3, 6, and 12 Inch Extensions, Hinge Handle, Universal Joint, Speed Handle, Sliding T-Handle, and Metal Box.
- › Weight (lbs): 22.50



| Contents | Description | ASME Spec. | AS Spec. |
|----------|---------------------------------|--------------|---------------|
| J5206M | Socket, 3/8" DR 6 mm 12 PT | ASME B107.5M | AS954E S3.8.1 |
| J5207M | Socket, 3/8" DR 7 mm 12 PT | ASME B107.5M | AS954E S3.8.1 |
| J5208M | Socket, 3/8" DR 8 mm 12 PT | ASME B107.5M | AS954E S3.8.1 |
| J5209M | Socket, 3/8" DR 9 mm 12 PT | ASME B107.5M | AS954E S3.8.1 |
| J5210M | Socket, 3/8" DR 10 mm 12 PT | ASME B107.5M | AS954E S3.8.1 |
| J5211M | Socket, 3/8" DR 11 mm 12 PT | ASME B107.5M | AS954E S3.8.1 |
| J5212M | Socket, 3/8" DR 12 mm 12 PT | ASME B107.5M | AS954E S3.8.1 |
| J5213M | Socket, 3/8" DR 13 mm 12 PT | ASME B107.5M | AS954E S3.8.1 |
| J5214M | Socket, 3/8" DR 14 mm 12 PT | ASME B107.5M | AS954E S3.8.1 |
| J5215M | Socket, 3/8" DR 15 mm 12 PT | ASME B107.5M | AS954E S3.8.1 |
| J5216M | Socket, 3/8" DR 16 mm 12 PT | ASME B107.5M | AS954E S3.8.1 |
| J5217M | Socket, 3/8" DR 17 mm 12 PT | ASME B107.5M | AS954E S3.8.1 |
| J5218M | Socket, 3/8" DR 18 mm 12 PT | ASME B107.5M | AS954E S3.8.1 |
| J5219M | Socket, 3/8" DR 19 mm 12 PT | ASME B107.5M | AS954E S3.8.1 |
| J5220M | Socket, 3/8" DR 20 mm 12 PT | ASME B107.5M | AS954E S3.8.1 |
| J5221M | Socket, 3/8" DR 21 mm 12 PT | ASME B107.5M | AS954E S3.8.1 |
| J5222M | Socket, 3/8" DR 22 mm 12 PT | ASME B107.5M | AS954E S3.8.1 |
| J5006M | Socket, 3/8" DR 6 mm 12 PT Deep | ASME B107.5M | AS954E S3.8.1 |
| J5007M | Socket, 3/8" DR 7 mm 12 PT Deep | ASME B107.5M | AS954E S3.8.1 |





| Contents | Description | ASME Spec. | AS Spec. |
|-----------|---|---------------|---------------|
| J5008M | Socket, 3/8" DR 8 mm 12 PT Deep | ASME B107.5M | AS954E S3.8.1 |
| J5009M | Socket, 3/8" DR 9 mm 12 PT Deep | ASME B107.5M | AS954E S3.8.1 |
| J5010M | Socket, 3/8" DR 10 mm 12 PT Deep | ASME B107.5M | AS954E S3.8.1 |
| J5011M | Socket, 3/8" DR 11 mm 12 PT Deep | ASME B107.5M | AS954E S3.8.1 |
| J5012M | Socket, 3/8" DR 12 mm 12 PT Deep | ASME B107.5M | AS954E S3.8.1 |
| J5013M | Socket, 3/8" DR 13 mm 12 PT Deep | ASME B107.5M | AS954E S3.8.1 |
| J5014M | Socket, 3/8" DR 14 mm 12 PT Deep | ASME B107.5M | AS954E S3.8.1 |
| J5015M | Socket, 3/8" DR 15 mm 12 PT Deep | ASME B107.5M | AS954E S3.8.1 |
| J5016M | Socket, 3/8" DR 16 mm 12 PT Deep | ASME B107.5M | AS954E S3.8.1 |
| J5017M | Socket, 3/8" DR 17 mm 12 PT Deep | ASME B107.5M | AS954E S3.8.1 |
| J5018M | Socket, 3/8" DR 18 mm 12 PT Deep | ASME B107.5M | AS954E S3.8.1 |
| J5019M | Socket, 3/8" DR 19 mm 12 PT Deep | ASME B107.5M | AS954E S3.8.1 |
| J5272M | Socket, 3/8" DR Universal 9 mm 12 PT | ASME B107.5M | |
| J5273M | Socket, 3/8" DR Universal 10 mm 12 PT | ASME B107.5M | |
| J5274M | Socket, 3/8" DR Universal 11 mm 12 PT | ASME B107.5M | |
| J5275M | Socket, 3/8" DR Universal 12 mm 12 PT | ASME B107.5M | |
| J5276M | Socket, 3/8" DR Universal 13 mm 12 PT | ASME B107.5M | |
| J5277M | Socket, 3/8" DR Universal 14 mm 12 PT | ASME B107.5M | |
| J5278M | Socket, 3/8" DR Universal 15 mm 12 PT | ASME B107.5M | |
| J4990-4M | Socket, Hex Bit 3/8" DR 4 mm | | |
| J4990-5M | Socket, Hex Bit 3/8" DR 5 mm | | |
| J4990-6M | Socket, Hex Bit 3/8" DR 6 mm | | |
| J4990-7M | Socket, Hex Bit 3/8" DR 7 mm | | |
| J4990-8M | Socket, Hex Bit 3/8" DR 8 mm | | |
| J4990-10M | Socket, Hex Bit 3/8" DR 10 mm | | |
| J5241 | Socket, Bit 3/8" DR #2 Phillips® | | |
| J5242 | Socket, Bit 3/8" DR #3 Phillips® | | |
| J5243 | Socket, Bit 3/8" DR #4 Phillips® | | |
| J5246 | Socket, Bit 3/8" DR Slotted | | |
| J5247 | Ratchet, Adapter 3/8" DR 2-1/16" | ASME B107.500 | |
| J5249 | Ratchet, 3/8" DR Standard Length Classic Pear Head 7" | ASME B107.500 | |
| J5260 | Extension, 3/8" DR 3" | ASME B107.500 | AS 4283 |
| J5260-06 | Extension, 3/8" DR 6" | ASME B107.500 | AS 4283 |
| J5262 | Extension, 3/8" DR 12" | ASME B107.500 | AS 4283 |
| J5265 | Handle, Hinge 3/8" DR 8-1/2" | ASME B107.500 | AS 4283 |
| J5270A | Universal Joint, 3/8" DR 2" | ASME B107.500 | |
| J5280G | Handle, Speed 3/8" DR 17-1/2" | ASME B107.500 | AS4283 |
| J5285 | Handle, Sliding T 3/8" DR 8" | ASME B107.500 | |
| J9977-NA | General Purpose Box with Tray | | |



3/8" DRIVE 57 PIECE METRIC SOCKET SET - 12 POINT - TOOLS ONLY

Product #: J52228



- ▶ 12 Point Standard: 6, 7, 8, 9, 10, 11, 12, 13, 14, 15, 16, 17, 18, 19, 20, 21, 22 mm.
- ▶ 12 Point Deep: 6, 7, 8, 9, 10, 11, 12, 13, 14, 15, 16, 17, 18, 19 mm.
- ▶ Universal: 9, 10, 11, 12, 13, 14, 15 mm.
- ▶ Hex: 4, 5, 6, 7, 8, 10 mm.
- ▶ Screwdriver Bit: #2, #3, #4 Phillips®, and 1/4 Inch Slotted.
- ▶ Accessories: Pear Head Ratchet and Adapter, 3, 6, and 12 Inch Extensions, Hinge Handle, Universal Joint, Speed Handle, and Sliding T-Handle.
- ▶ Weight (lbs): 10.76



| Contents | Description | ASME Spec. | AS Spec. |
|----------|---------------------------------------|--------------|---------------|
| J5206M | Socket, 3/8" DR 6 mm 12 PT | ASME B107.5M | AS954E S3.8.1 |
| J5207M | Socket, 3/8" DR 7 mm 12 PT | ASME B107.5M | AS954E S3.8.1 |
| J5208M | Socket, 3/8" DR 8 mm 12 PT | ASME B107.5M | AS954E S3.8.1 |
| J5209M | Socket, 3/8" DR 9 mm 12 PT | ASME B107.5M | AS954E S3.8.1 |
| J5210M | Socket, 3/8" DR 10 mm 12 PT | ASME B107.5M | AS954E S3.8.1 |
| J5211M | Socket, 3/8" DR 11 mm 12 PT | ASME B107.5M | AS954E S3.8.1 |
| J5212M | Socket, 3/8" DR 12 mm 12 PT | ASME B107.5M | AS954E S3.8.1 |
| J5213M | Socket, 3/8" DR 13 mm 12 PT | ASME B107.5M | AS954E S3.8.1 |
| J5214M | Socket, 3/8" DR 14 mm 12 PT | ASME B107.5M | AS954E S3.8.1 |
| J5215M | Socket, 3/8" DR 15 mm 12 PT | ASME B107.5M | AS954E S3.8.1 |
| J5216M | Socket, 3/8" DR 16 mm 12 PT | ASME B107.5M | AS954E S3.8.1 |
| J5217M | Socket, 3/8" DR 17 mm 12 PT | ASME B107.5M | AS954E S3.8.1 |
| J5218M | Socket, 3/8" DR 18 mm 12 PT | ASME B107.5M | AS954E S3.8.1 |
| J5219M | Socket, 3/8" DR 19 mm 12 PT | ASME B107.5M | AS954E S3.8.1 |
| J5220M | Socket, 3/8" DR 20 mm 12 PT | ASME B107.5M | AS954E S3.8.1 |
| J5221M | Socket, 3/8" DR 21 mm 12 PT | ASME B107.5M | AS954E S3.8.1 |
| J5222M | Socket, 3/8" DR 22 mm 12 PT | ASME B107.5M | AS954E S3.8.1 |
| J5006M | Socket, 3/8" DR 6 mm 12 PT Deep | ASME B107.5M | AS954E S3.8.1 |
| J5007M | Socket, 3/8" DR 7 mm 12 PT Deep | ASME B107.5M | AS954E S3.8.1 |
| J5008M | Socket, 3/8" DR 8 mm 12 PT Deep | ASME B107.5M | AS954E S3.8.1 |
| J5009M | Socket, 3/8" DR 9 mm 12 PT Deep | ASME B107.5M | AS954E S3.8.1 |
| J5010M | Socket, 3/8" DR 10 mm 12 PT Deep | ASME B107.5M | AS954E S3.8.1 |
| J5011M | Socket, 3/8" DR 11 mm 12 PT Deep | ASME B107.5M | AS954E S3.8.1 |
| J5012M | Socket, 3/8" DR 12 mm 12 PT Deep | ASME B107.5M | AS954E S3.8.1 |
| J5013M | Socket, 3/8" DR 13 mm 12 PT Deep | ASME B107.5M | AS954E S3.8.1 |
| J5014M | Socket, 3/8" DR 14 mm 12 PT Deep | ASME B107.5M | AS954E S3.8.1 |
| J5015M | Socket, 3/8" DR 15 mm 12 PT Deep | ASME B107.5M | AS954E S3.8.1 |
| J5016M | Socket, 3/8" DR 16 mm 12 PT Deep | ASME B107.5M | AS954E S3.8.1 |
| J5017M | Socket, 3/8" DR 17 mm 12 PT Deep | ASME B107.5M | AS954E S3.8.1 |
| J5018M | Socket, 3/8" DR 18 mm 12 PT Deep | ASME B107.5M | AS954E S3.8.1 |
| J5019M | Socket, 3/8" DR 19 mm 12 PT Deep | ASME B107.5M | AS954E S3.8.1 |
| J5272M | Socket, 3/8" DR Universal 9 mm 12 PT | ASME B107.5M | |
| J5273M | Socket, 3/8" DR Universal 10 mm 12 PT | ASME B107.5M | |
| J5274M | Socket, 3/8" DR Universal 11 mm 12 PT | ASME B107.5M | |
| J5275M | Socket, 3/8" DR Universal 12 mm 12 PT | ASME B107.5M | |
| J5276M | Socket, 3/8" DR Universal 13 mm 12 PT | ASME B107.5M | |
| J5277M | Socket, 3/8" DR Universal 14 mm 12 PT | ASME B107.5M | |
| J5278M | Socket, 3/8" DR Universal 15 mm 12 PT | ASME B107.5M | |
| J4990-4M | Socket, Hex Bit 3/8" DR 4 mm | | |
| J4990-5M | Socket, Hex Bit 3/8" DR 5 mm | | |
| J4990-6M | Socket, Hex Bit 3/8" DR 6 mm | | |





| Contents | Description | ASME Spec. | AS Spec. |
|-----------|---|---------------|----------|
| J4990-7M | Socket, Hex Bit 3/8" DR 7 mm | | |
| J4990-8M | Socket, Hex Bit 3/8" DR 8 mm | | |
| J4990-10M | Socket, Hex Bit 3/8" DR 10 mm | | |
| J5241 | Socket, Bit 3/8" DR #2 Phillips® | | |
| J5242 | Socket, Bit 3/8" DR #3 Phillips® | | |
| J5243 | Socket, Bit 3/8" DR #4 Phillips® | | |
| J5246 | Socket, Bit 3/8" DR Slotted | | |
| J5247 | Ratchet, Adapter 3/8" DR 2-1/16" | ASME B107.500 | |
| J5249 | Ratchet, 3/8" DR Standard Length Classic Pear Head 7" | ASME B107.500 | |
| J5260 | Extension, 3/8" DR 3" | ASME B107.500 | AS 4283 |
| J5260-06 | Extension, 3/8" DR 6" | ASME B107.500 | AS 4283 |
| J5262 | Extension, 3/8" DR 12" | ASME B107.500 | AS 4283 |
| J5265 | Handle, Hinge 3/8" DR 8-1/2" | ASME B107.500 | AS 4283 |
| J5270A | Universal Joint, 3/8" DR 2" | ASME B107.500 | |
| J5280G | Handle, Speed 3/8" DR 17-1/2" | ASME B107.500 | |
| J5285 | Handle, Sliding T 3/8" DR 8" | ASME B107.500 | |

3/8" DRIVE 22 PIECE SOCKET SET - 6 POINT

Product #: J52134

- › 6 Point Standard: 3/8, 7/16, 1/2, 9/16, 5/8, 11/16, 3/4, 13/16, 7/8 Inch.
- › 6 Point Deep: 3/8, 7/16, 1/2, 9/16, 5/8, 11/16, 3/4, 13/16, 7/8 Inch.
- › Accessories: Pear Head Ratchet, 3 and 6 Inch Extensions, Universal Joint, and Blow-Molded Case.
- › Weight (lbs): 7.63



| Contents | Description | ASME Spec. | AS Spec. |
|----------|---|---------------|----------|
| J5212H | Socket, 3/8" DR 3/8" 6 PT | ASME B107.1 | |
| J5214H | Socket, 3/8" DR 7/16" 6 PT | ASME B107.1 | |
| J5216H | Socket, 3/8" DR 1/2" 6 PT | ASME B107.1 | |
| J5218H | Socket, 3/8" DR 9/16" 6 PT | ASME B107.1 | |
| J5220H | Socket, 3/8" DR 5/8" 6 PT | ASME B107.1 | |
| J5222H | Socket, 3/8" DR 11/16" 6 PT | ASME B107.1 | |
| J5224H | Socket, 3/8" DR 3/4" 6 PT | ASME B107.1 | |
| J5226H | Socket, 3/8" DR 13/16" 6 PT | ASME B107.1 | |
| J5228H | Socket, 3/8" DR 7/8" 6 PT | ASME B107.1 | |
| J5012H | Socket, 3/8" DR 3/8" 6 PT Deep | ASME B107.1 | |
| J5014H | Socket, 3/8" DR 7/16" 6 PT Deep | ASME B107.1 | |
| J5016H | Socket, 3/8" DR 1/2" 6 PT Deep | ASME B107.1 | |
| J5018H | Socket, 3/8" DR 9/16" 6 PT Deep | ASME B107.1 | |
| J5020H | Socket, 3/8" DR 5/8" 6 PT Deep | ASME B107.1 | |
| J5022H | Socket, 3/8" DR 11/16" 6 PT Deep | ASME B107.1 | |
| J5024H | Socket, 3/8" DR 3/4" 6 PT Deep | ASME B107.1 | |
| J5026H | Socket, 3/8" DR 13/16" 6 PT Deep | ASME B107.1 | |
| J5028H | Socket, 3/8" DR 7/8" 6 PT Deep | ASME B107.1 | |
| J5249 | Ratchet, 3/8" DR Standard Length Classic Pear Head 7" | ASME B107.500 | |
| J5260 | Extension, 3/8" DR 3" | ASME B107.500 | AS 4283 |
| J5260-06 | Extension, 3/8" DR 6" | ASME B107.500 | AS 4283 |
| J5270A | Joint, Universal 3/8" DR 2" | ASME B107.500 | |
| JBM1102 | Blow-Molded Case | | |



3/8" DRIVE 22 PIECE SOCKET SET - 6 POINT

Product #: **J52134XL**

- › 6 Point Standard: 3/8, 7/16, 1/2, 9/16, 5/8, 11/16, 3/4, 13/16, 7/8 Inch.
- › 6 Point Deep: 3/8, 7/16, 1/2, 9/16, 5/8, 11/16, 3/4, 13/16, 7/8 Inch.
- › Accessories: Premium Ratchet, 3 and 6 Inch Extensions, Universal Joint, and Blow-Molded Case.
- › Weight (lbs): 7.84



| Contents | Description | ASME Spec. | AS Spec. |
|----------|---|---------------|----------|
| J5012H | Socket, 3/8" DR 3/8" 6 PT Deep | ASME B107.1 | |
| J5014H | Socket, 3/8" DR 7/16" 6 PT Deep | ASME B107.1 | |
| J5016H | Socket, 3/8" DR 1/2" 6 PT Deep | ASME B107.1 | |
| J5018H | Socket, 3/8" DR 9/16" 6 PT Deep | ASME B107.1 | |
| J5020H | Socket, 3/8" DR 5/8" 6 PT Deep | ASME B107.1 | |
| J5022H | Socket, 3/8" DR 11/16" 6 PT Deep | ASME B107.1 | |
| J5024H | Socket, 3/8" DR 3/4" 6 PT Deep | ASME B107.1 | |
| J5026H | Socket, 3/8" DR 13/16" 6 PT Deep | ASME B107.1 | |
| J5028H | Socket, 3/8" DR 7/8" 6 PT Deep | ASME B107.1 | |
| J5212H | Socket, 3/8" DR 3/8" 6 PT | ASME B107.1 | |
| J5214H | Socket, 3/8" DR 7/16" 6 PT | ASME B107.1 | |
| J5216H | Socket, 3/8" DR 1/2" 6 PT | ASME B107.1 | |
| J5218H | Socket, 3/8" DR 9/16" 6 PT | ASME B107.1 | |
| J5220H | Socket, 3/8" DR 5/8" 6 PT | ASME B107.1 | |
| J5222H | Socket, 3/8" DR 11/16" 6 PT | ASME B107.1 | |
| J5224H | Socket, 3/8" DR 3/4" 6 PT | ASME B107.1 | |
| J5226H | Socket, 3/8" DR 13/16" 6 PT | ASME B107.1 | |
| J5228H | Socket, 3/8" DR 7/8" 6 PT | ASME B107.1 | |
| J5249XL | Ratchet, 3/8" DR Standard Length Premium Pear Head 8-1/2" | ASME B107.500 | |
| J5260 | Extension, 3/8" DR 3" | ASME B107.500 | AS 4283 |
| J5260-06 | Extension, 3/8" DR 6" | ASME B107.500 | AS 4283 |
| J5270A | Joint, Universal 3/8" DR 2" | ASME B107.500 | |
| JBM1102 | Blow-Molded Case | | |





3/8" DRIVE 22 PIECE SOCKET SET- 12 POINT

Product #: J52136

- › 12 Point Standard: 3/8, 7/16, 1/2, 9/16, 5/8, 11/16, 3/4, 13/16, 7/8 Inch.
- › 12 Point Deep: 3/8, 7/16, 1/2, 9/16, 5/8, 11/16, 3/4, 13/16, 7/8 Inch.
- › Accessories: Pear Head Ratchet, 3 and 6 Inch Extensions, Universal Joint, and Blow-Molded Case.
- › Weight (lbs): 7.70



| Contents | Description | ASME Spec. | AS Spec. |
|----------|---|---------------|---------------|
| J5212 | Socket, 3/8" DR 3/8" 12 PT | ASME B107.1 | AS954E S3.8.1 |
| J5214 | Socket, 3/8" DR 7/16" 12 PT | ASME B107.1 | AS954E S3.8.1 |
| J5216 | Socket, 3/8" DR 1/2" 12 PT | ASME B107.1 | AS954E S3.8.1 |
| J5218 | Socket, 3/8" DR 9/16" 12 PT | ASME B107.1 | AS954E S3.8.1 |
| J5220 | Socket, 3/8" DR 5/8" 12 PT | ASME B107.1 | AS954E S3.8.1 |
| J5222 | Socket, 3/8" DR 11/16" 12 PT | ASME B107.1 | AS954E S3.8.1 |
| J5224 | Socket, 3/8" DR 3/4" 12 PT | ASME B107.1 | AS954E S3.8.1 |
| J5226 | Socket, 3/8" DR 13/16" 12 PT | ASME B107.1 | AS954E S3.8.1 |
| J5228 | Socket, 3/8" DR 7/8" 12 PT | ASME B107.1 | AS954E S3.8.1 |
| J5012 | Socket, 3/8" DR 3/8" 12 PT Deep | ASME B107.1 | AS954E S3.8.1 |
| J5014 | Socket, 3/8" DR 7/16" 12 PT Deep | ASME B107.1 | AS954E S3.8.1 |
| J5016 | Socket, 3/8" DR 1/2" 12 PT Deep | ASME B107.1 | AS954E S3.8.1 |
| J5018 | Socket, 3/8" DR 9/16" 12 PT Deep | ASME B107.1 | AS954E S3.8.1 |
| J5020 | Socket, 3/8" DR 5/8" 12 PT Deep | ASME B107.1 | AS954E S3.8.1 |
| J5022 | Socket, 3/8" DR 11/16" 12 PT Deep | ASME B107.1 | AS954E S3.8.1 |
| J5024 | Socket, 3/8" DR 3/4" 12 PT Deep | ASME B107.1 | AS954E S3.8.1 |
| J5026 | Socket, 3/8" DR 13/16" 12 PT Deep | ASME B107.1 | AS954E S3.8.1 |
| J5028 | Socket, 3/8" DR 7/8" 12 PT Deep | ASME B107.1 | AS954E S3.8.1 |
| J5249 | Ratchet, 3/8" DR Standard Length Classic Pear Head 7" | ASME B107.500 | |
| J5260 | Extension, 3/8" DR 3" | ASME B107.500 | AS 4283 |
| J5260-06 | Extension, 3/8" DR 6" | ASME B107.500 | AS 4283 |
| J5270A | Joint, Universal 3/8" DR 2" | ASME B107.500 | |
| JBM1102 | Blow-Molded Case | | |



3/8" DRIVE 22 PIECE SOCKET SET- 12 POINT

Product #: **J52136XL**

- ▶ 12 Point Standard: 3/8, 7/16, 1/2, 9/16, 5/8, 11/16, 3/4, 13/16, 7/8 Inch.
- ▶ 12 Point Deep: 3/8, 7/16, 1/2, 9/16, 5/8, 11/16, 3/4, 13/16, 7/8 Inch.
- ▶ Accessories: Premium Ratchet, 3 and 6 Inch Extensions, Universal Joint, and Blow-Molded Case.
- ▶ Weight (lbs): 6.60



| Contents | Description | ASME Spec. | AS Spec. |
|----------|---|---------------|---------------|
| J5012 | Socket, 3/8" DR 3/8" 12 PT Deep | | |
| J5014 | Socket, 3/8" DR 7/16" 12 PT Deep | ASME B107.1 | AS954E S3.8.1 |
| J5016 | Socket, 3/8" DR 1/2" 12 PT Deep | | |
| J5018 | Socket, 3/8" DR 9/16" 12 PT Deep | | |
| J5020 | Socket, 3/8" DR 5/8" 12 PT Deep | ASME B107.1 | AS954E S3.8.1 |
| J5022 | Socket, 3/8" DR 11/16" 12 PT Deep | | |
| J5024 | Socket, 3/8" DR 3/4" 12 PT Deep | ASME B107.1 | AS954E S3.8.1 |
| J5026 | Socket, 3/8" DR 13/16" 12 PT Deep | ASME B107.1 | AS954E S3.8.1 |
| J5028 | Socket, 3/8" DR 7/8" 12 PT Deep | ASME B107.1 | AS954E S3.8.1 |
| J5212 | Socket, 3/8" DR 3/8" 12 PT | ASME B107.1 | AS954E S3.8.1 |
| J5214 | Socket, 3/8" DR 7/16" 12 PT | ASME B107.1 | AS954E S3.8.1 |
| J5216 | Socket, 3/8" DR 1/2" 12 PT | ASME B107.1 | AS954E S3.8.1 |
| J5218 | Socket, 3/8" DR 9/16" 12 PT | ASME B107.1 | AS954E S3.8.1 |
| J5220 | Socket, 3/8" DR 5/8" 12 PT | ASME B107.1 | AS954E S3.8.1 |
| J5222 | Socket, 3/8" DR 11/16" 12 PT | ASME B107.1 | AS954E S3.8.1 |
| J5224 | Socket, 3/8" DR 3/4" 12 PT | ASME B107.1 | AS954E S3.8.1 |
| J5226 | Socket, 3/8" DR 13/16" 12 PT | ASME B107.1 | AS954E S3.8.1 |
| J5228 | Socket, 3/8" DR 7/8" 12 PT | ASME B107.1 | AS954E S3.8.1 |
| J5249XL | Ratchet, 3/8" DR Standard Length Premium Pear Head 8-1/2" | ASME B107.500 | |
| J5260 | Extension, 3/8" DR 3" | ASME B107.500 | AS 4283 |
| J5260-06 | Extension, 3/8" DR 6" | ASME B107.500 | AS 4283 |
| J5270A | Joint, Universal 3/8" DR 2" | ASME B107.500 | |
| JBM1102 | Blow-Molded Case | | |

3/8" DRIVE 16 PIECE METRIC SOCKET SET - 12 POINT

Product #: **J52218**

- ▶ 12 Point Standard: 6, 7, 8, 9, 10, 11, 12, 13, 14, 15, 16, 17, 18, 19 mm.
- ▶ Accessories: Pear Head Ratchet, 6 Inch Extension, and Blow-Molded Case.
- ▶ Weight (lbs): 4.07



METRIC



| Contents | Description | ASME Spec. | AS Spec. |
|----------|---|---------------|---------------|
| J5206M | Socket, 3/8" DR 6 mm 12 PT | ASME B107.5M | AS954E S3.8.1 |
| J5207M | Socket, 3/8" DR 7 mm 12 PT | ASME B107.5M | AS954E S3.8.1 |
| J5208M | Socket, 3/8" DR 8 mm 12 PT | ASME B107.5M | AS954E S3.8.1 |
| J5209M | Socket, 3/8" DR 9 mm 12 PT | ASME B107.5M | AS954E S3.8.1 |
| J5210M | Socket, 3/8" DR 10 mm 12 PT | ASME B107.5M | AS954E S3.8.1 |
| J5211M | Socket, 3/8" DR 11 mm 12 PT | ASME B107.5M | AS954E S3.8.1 |
| J5212M | Socket, 3/8" DR 12 mm 12 PT | ASME B107.5M | AS954E S3.8.1 |
| J5213M | Socket, 3/8" DR 13 mm 12 PT | ASME B107.5M | AS954E S3.8.1 |
| J5214M | Socket, 3/8" DR 14 mm 12 PT | ASME B107.5M | AS954E S3.8.1 |
| J5215M | Socket, 3/8" DR 15 mm 12 PT | ASME B107.5M | AS954E S3.8.1 |
| J5216M | Socket, 3/8" DR 16 mm 12 PT | ASME B107.5M | AS954E S3.8.1 |
| J5217M | Socket, 3/8" DR 17 mm 12 PT | ASME B107.5M | AS954E S3.8.1 |
| J5218M | Socket, 3/8" DR 18 mm 12 PT | ASME B107.5M | AS954E S3.8.1 |
| J5219M | Socket, 3/8" DR 19 mm 12 PT | ASME B107.5M | AS954E S3.8.1 |
| J5249 | Ratchet, 3/8" DR Standard Length Classic Pear Head 7" | ASME B107.500 | |
| J5260-06 | Extension, 3/8" DR 6" | ASME B107.500 | AS 4283 |
| JBM1101 | Blow-Molded Case | | |





3/8" DRIVE 16 PIECE METRIC SOCKET SET - 12 POINT

Product #: J52218XL

- › 12 Point Standard: 6, 7, 8, 9, 10, 11, 12, 13, 14, 15, 16, 17, 18, 19 mm.
- › Accessories: Premium Ratchet, 6 Inch Extension, and Blow-Molded Case.
- › Weight (lbs): 4.48



| Contents | Description | ASME Spec. | AS Spec. |
|----------|---|---------------|---------------|
| J5206M | Socket, 3/8" DR 6 mm 12 PT | ASME B107.5M | AS954E S3.8.1 |
| J5207M | Socket, 3/8" DR 7 mm 12 PT | ASME B107.5M | AS954E S3.8.1 |
| J5208M | Socket, 3/8" DR 8 mm 12 PT | ASME B107.5M | AS954E S3.8.1 |
| J5209M | Socket, 3/8" DR 9 mm 12 PT | ASME B107.5M | AS954E S3.8.1 |
| J5210M | Socket, 3/8" DR 10 mm 12 PT | ASME B107.5M | AS954E S3.8.1 |
| J5211M | Socket, 3/8" DR 11 mm 12 PT | ASME B107.5M | AS954E S3.8.1 |
| J5212M | Socket, 3/8" DR 12 mm 12 PT | ASME B107.5M | AS954E S3.8.1 |
| J5213M | Socket, 3/8" DR 13 mm 12 PT | ASME B107.5M | AS954E S3.8.1 |
| J5214M | Socket, 3/8" DR 14 mm 12 PT | ASME B107.5M | AS954E S3.8.1 |
| J5215M | Socket, 3/8" DR 15 mm 12 PT | ASME B107.5M | AS954E S3.8.1 |
| J5216M | Socket, 3/8" DR 16 mm 12 PT | ASME B107.5M | AS954E S3.8.1 |
| J5217M | Socket, 3/8" DR 17 mm 12 PT | ASME B107.5M | AS954E S3.8.1 |
| J5218M | Socket, 3/8" DR 18 mm 12 PT | ASME B107.5M | AS954E S3.8.1 |
| J5219M | Socket, 3/8" DR 19 mm 12 PT | ASME B107.5M | AS954E S3.8.1 |
| J5249XL | Ratchet, 3/8" DR Standard Length Premium Pear Head 8-1/2" | ASME B107.500 | |
| J5260-06 | Extension, 3/8" DR 6" | ASME B107.500 | AS 4283 |
| JBM1101 | Blow-Molded Case | | |

3/8" DRIVE 15 PIECE SOCKET SET - 12 POINT

Product #: J52132

- › 12 Point Standard: 3/8, 7/16, 1/2, 9/16, 5/8, 11/16, 3/4, 13/16, 7/8 Inch.
- › Accessories: Pear Head Ratchet, 3 and 12 Inch Extensions, Hinge Handle, Universal Joint, Speed Handle, and Blow-Molded Case.
- › Weight (lbs): 8.18



| Contents | Description | ASME Spec. | AS Spec. |
|----------|---|---------------|---------------|
| J5212 | Socket, 3/8" DR 3/8" 12 PT | ASME B107.1 | AS954E S3.8.1 |
| J5214 | Socket, 3/8" DR 7/16" 12 PT | ASME B107.1 | AS954E S3.8.1 |
| J5216 | Socket, 3/8" DR 1/2" 12 PT | ASME B107.1 | AS954E S3.8.1 |
| J5218 | Socket, 3/8" DR 9/16" 12 PT | ASME B107.1 | AS954E S3.8.1 |
| J5220 | Socket, 3/8" DR 5/8" 12 PT | ASME B107.1 | AS954E S3.8.1 |
| J5222 | Socket, 3/8" DR 11/16" 12 PT | ASME B107.1 | AS954E S3.8.1 |
| J5224 | Socket, 3/8" DR 3/4" 12 PT | ASME B107.1 | AS954E S3.8.1 |
| J5226 | Socket, 3/8" DR 13/16" 12 PT | ASME B107.1 | AS954E S3.8.1 |
| J5228 | Socket, 3/8" DR 7/8" 12 PT | ASME B107.1 | AS954E S3.8.1 |
| J5249 | Ratchet, 3/8" DR Standard Length Classic Pear Head 7" | ASME B107.500 | |
| J5260 | Extension, 3/8" DR 3" | ASME B107.500 | AS 4283 |
| J5262 | Extension, 3/8" DR 12" | ASME B107.500 | AS 4283 |
| J5265 | Handle, Hinge 3/8" DR 8-1/2" | ASME B107.500 | AS 4283 |
| J5270A | Joint, Universal 3/8" DR 2" | ASME B107.500 | |
| J5280G | Handle, Speed 3/8" DR 17-1/2" | ASME B107.500 | |
| JBM1105 | Blow-Molded Case | | |



3/8" DRIVE 15 PIECE SOCKET SET - 12 POINT

Product #: **J52132XL**

- ▶ 12 Point Standard: 3/8, 7/16, 1/2, 9/16, 5/8, 11/16, 3/4, 13/16, 7/8 Inch.
- ▶ Accessories: Premium Ratchet, 3 and 6 Inch Extensions, Hinge handle, Universal Joint, Speed Handle, and Blow-Molded Case.
- ▶ Weight (lbs): 8.34



| Contents | Description | ASME Spec. | AS Spec. |
|----------|---|---------------|---------------|
| J5212 | Socket, 3/8" DR 3/8" 12 PT | ASME B107.1 | AS954E S3.8.1 |
| J5214 | Socket, 3/8" DR 7/16" 12 PT | ASME B107.1 | AS954E S3.8.1 |
| J5216 | Socket, 3/8" DR 1/2" 12 PT | ASME B107.1 | AS954E S3.8.1 |
| J5218 | Socket, 3/8" DR 9/16" 12 PT | ASME B107.1 | AS954E S3.8.1 |
| J5220 | Socket, 3/8" DR 5/8" 12 PT | ASME B107.1 | AS954E S3.8.1 |
| J5222 | Socket, 3/8" DR 11/16" 12 PT | ASME B107.1 | AS954E S3.8.1 |
| J5224 | Socket, 3/8" DR 3/4" 12 PT | ASME B107.1 | AS954E S3.8.1 |
| J5226 | Socket, 3/8" DR 13/16" 12 PT | ASME B107.1 | AS954E S3.8.1 |
| J5228 | Socket, 3/8" DR 7/8" 12 PT | ASME B107.1 | AS954E S3.8.1 |
| J5249XL | Ratchet, 3/8" DR Standard Length Premium Pear Head 8-1/2" | ASME B107.500 | |
| J5260 | Extension, 3/8" DR 3" | ASME B107.500 | AS 4283 |
| J5262 | Extension, 3/8" DR 12" | ASME B107.500 | AS 4283 |
| J5265 | Handle, Hinge 3/8" DR 8-1/2" | ASME B107.500 | AS 4283 |
| J5270A | Joint, Universal 3/8" DR 2" | ASME B107.500 | |
| J5280G | Handle, Speed 3/8" DR 17-1/2" | ASME B107.500 | |
| JBM1105 | Blow-Molded Case | | |

3/8" DRIVE 12 PIECE SOCKET SET - 6 POINT

Product #: **J52128**

- ▶ 6 Point Standard: 3/8, 7/16, 1/2, 9/16, 5/8, 11/16, 3/4, 13/16, 7/8 Inch.
- ▶ Accessories: Pear Head Ratchet, 3 and 6 Inch Extensions, and Blow-Molded Case.
- ▶ Weight (lbs): 3.67



| Contents | Description | ASME Spec. | AS Spec. |
|----------|---|---------------|----------|
| J5212H | Socket, 3/8" DR 3/8" 6 PT | ASME B107.1 | |
| J5214H | Socket, 3/8" DR 7/16" 6 PT | ASME B107.1 | |
| J5216H | Socket, 3/8" DR 1/2" 6 PT | ASME B107.1 | |
| J5218H | Socket, 3/8" DR 9/16" 6 PT | ASME B107.1 | |
| J5220H | Socket, 3/8" DR 5/8" 6 PT | ASME B107.1 | |
| J5222H | Socket, 3/8" DR 11/16" 6 PT | ASME B107.1 | |
| J5224H | Socket, 3/8" DR 3/4" 6 PT | ASME B107.1 | |
| J5226H | Socket, 3/8" DR 13/16" 6 PT | ASME B107.1 | |
| J5228H | Socket, 3/8" DR 7/8" 6 PT | ASME B107.1 | |
| J5249 | Ratchet, 3/8" DR Standard Length Classic Pear Head 7" | ASME B107.500 | |
| J5260 | Extension, 3/8" DR 3" | ASME B107.500 | AS 4283 |
| J5260-06 | Extension, 3/8" DR 6" | ASME B107.500 | AS 4283 |
| JBM1103 | Blow-Molded Case | | |



3/8" DRIVE 12 PIECE SOCKET SET - 6 POINT

Product #: **J52128XL**

- › 6 Point Standard: 3/8, 7/16, 1/2, 9/16, 5/8, 11/16, 3/4, 13/16, 7/8 Inch.
- › Accessories: Premium Ratchet, 3 and 6 Inch Extensions, and Blow-Molded Case.
- › Weight (lbs): 4.03



| Contents | Description | ASME Spec. | AS Spec. |
|----------|---|---------------|----------|
| J5212H | Socket, 3/8" DR 3/8" 6 PT | ASME B107.1 | |
| J5214H | Socket, 3/8" DR 7/16" 6 PT | ASME B107.1 | |
| J5216H | Socket, 3/8" DR 1/2" 6 PT | ASME B107.1 | |
| J5218H | Socket, 3/8" DR 9/16" 6 PT | ASME B107.1 | |
| J5220H | Socket, 3/8" DR 5/8" 6 PT | ASME B107.1 | |
| J5222H | Socket, 3/8" DR 11/16" 6 PT | ASME B107.1 | |
| J5224H | Socket, 3/8" DR 3/4" 6 PT | ASME B107.1 | |
| J5226H | Socket, 3/8" DR 13/16" 6 PT | ASME B107.1 | |
| J5228H | Socket, 3/8" DR 7/8" 6 PT | ASME B107.1 | |
| J5249XL | Ratchet, 3/8" DR Standard Length Premium Pear Head 8-1/2" | ASME B107.500 | |
| J5260 | Extension, 3/8" DR 3" | ASME B107.500 | AS 4283 |
| J5260-06 | Extension, 3/8" DR 6" | ASME B107.500 | AS 4283 |
| JBM1103 | Blow-Molded Case | | |

1/4" & 3/8" DRIVE 22 PIECE SOCKET SET - 6 POINT

Product #: **J47152**

- › 1/4 Inch Drive 6 Point Standard: 3/16, 7/32, 1/4, 9/32, 5/16, 11/32, 3/8 Inch.
- › 3/8 Inch Drive 6 Point Standard: 7/16, 1/2, 9/16, 5/8, 11/16, 3/4, 13/16, 7/8, 15/16, 1 Inch.
- › Accessories: 1/4 Inch Drive Socket Driver, 3/8 Inch Drive Pear Head Ratchet, 3 and 6 Inch Extensions, 3/8 Inch Female x 1/4 Inch Male Adapter, and Blow-Molded Case.
- › Weight (lbs): 5.41



| Contents | Description | ASME Spec. | AS Spec. |
|----------|---|---------------|----------|
| J4706 | Socket, 1/4" DR 3/16" 6 PT | ASME B107.1 | |
| J4707 | Socket, 1/4" DR 7/32" 6 PT | ASME B107.1 | |
| J4708 | Socket, 1/4" DR 1/4" 6 PT | ASME B107.1 | |
| J4709 | Socket, 1/4" DR 9/32" 6 PT | ASME B107.1 | |
| J4710 | Socket, 1/4" DR 5/16" 6 PT | ASME B107.1 | |
| J4711 | Socket, 1/4" DR 11/32" 6 PT | ASME B107.1 | |
| J4712 | Socket, 1/4" DR 3/8" 6 PT | ASME B107.1 | |
| J4769 | Socket, Driver 1/4" DR | ASME B107.500 | |
| J5214H | Socket, 3/8" DR 7/16" 6 PT | ASME B107.1 | |
| J5216H | Socket, 3/8" DR 1/2" 6 PT | ASME B107.1 | |
| J5218H | Socket, 3/8" DR 9/16" 6 PT | ASME B107.1 | |
| J5220H | Socket, 3/8" DR 5/8" 6 PT | ASME B107.1 | |
| J5222H | Socket, 3/8" DR 11/16" 6 PT | ASME B107.1 | |
| J5224H | Socket, 3/8" DR 3/4" 6 PT | ASME B107.1 | |
| J5226H | Socket, 3/8" DR 13/16" 6 PT | ASME B107.1 | |
| J5228H | Socket, 3/8" DR 7/8" 6 PT | ASME B107.1 | |
| J5230H | Socket, 3/8" DR 15/16" 6 PT | ASME B107.1 | |
| J5232H | Socket, 3/8" DR 1" 6 PT | ASME B107.1 | |
| J5249 | Ratchet, 3/8" DR Standard Length Classic Pear Head 7" | ASME B107.500 | |
| J5255 | Adaper 3/8" F x 1/4" M | ASME B107.500 | |
| J5260 | Extension, 3/8" DR 3" | ASME B107.500 | AS 4283 |
| J5260-06 | Extension, 3/8" DR 6" | ASME B107.500 | AS 4283 |
| JBM1003 | Blow-Molded Case | | |



1/4" & 3/8" DRIVE 22 PIECE SOCKET SET - 6 POINT

Product #: **J47152XL**

- ▶ 1/4 Inch Drive 6 Point Standard: 3/16, 7/32, 1/4, 9/32, 5/16, 11/32, 3/8, 7/16, 1/2, 9/16 Inch.
- ▶ 3/8 Inch Drive 6 Point Standard: 7/16, 1/2, 9/16, 5/8, 11/16, 3/4, 13/16, 7/8, 15/16, and 1 Inch.
- ▶ Accessories: Premium Ratchet, Female x Male Adapter, 3 and 6 Inch Extensions, and Blow-Molded Case.
- ▶ Weight (lbs): 5.57



| Contents | Description | ASME Spec. | AS Spec. |
|----------|---|---------------|----------|
| J4706 | Socket, 1/4" DR 3/16" 6 PT | ASME B107.1 | |
| J4707 | Socket, 1/4" DR 7/32" 6 PT | ASME B107.1 | |
| J4708 | Socket, 1/4" DR 1/4" 6 PT | ASME B107.1 | |
| J4709 | Socket, 1/4" DR 9/32" 6 PT | ASME B107.1 | |
| J4710 | Socket, 1/4" DR 5/16" 6 PT | ASME B107.1 | |
| J4711 | Socket, 1/4" DR 11/32" 6 PT | ASME B107.1 | |
| J4712 | Socket, 1/4" DR 3/8" 6 PT | ASME B107.1 | |
| J4769 | Socket, Driver 1/4" DR | ASME B107.500 | |
| J5214H | Socket, 3/8" DR 7/16" 6 PT | ASME B107.1 | |
| J5216H | Socket, 3/8" DR 1/2" 6 PT | ASME B107.1 | |
| J5218H | Socket, 3/8" DR 9/16" 6 PT | ASME B107.1 | |
| J5220H | Socket, 3/8" DR 5/8" 6 PT | ASME B107.1 | |
| J5222H | Socket, 3/8" DR 11/16" 6 PT | ASME B107.1 | |
| J5224H | Socket, 3/8" DR 3/4" 6 PT | ASME B107.1 | |
| J5226H | Socket, 3/8" DR 13/16" 6 PT | ASME B107.1 | |
| J5228H | Socket, 3/8" DR 7/8" 6 PT | ASME B107.1 | |
| J5230H | Socket, 3/8" DR 15/16" 6 PT | ASME B107.1 | |
| J5232H | Socket, 3/8" DR 1" 6 PT | ASME B107.1 | |
| J5249XL | Ratchet, 3/8" DR Standard Length Premium Pear Head 8-1/2" | ASME B107.500 | |
| J5255 | Adaper 3/8" F x 1/4" M | ASME B107.500 | |
| J5260 | Extension, 3/8" DR 3" | ASME B107.500 | AS 4283 |
| J5260-06 | Extension, 3/8" DR 6" | ASME B107.500 | AS 4283 |
| JBM1003 | Blow-Molded Case | | |

3/8" DRIVE 12 PIECE SOCKET SET - 12 POINT

Product #: **J52130**

- ▶ 12 Point Standard: 3/8, 7/16, 1/2, 9/16, 5/8, 11/16, 3/4, 13/16, 7/8 Inch.
- ▶ Accessories: Pear Head Ratchet, 3 and 6 Inch Extensions, and Blow-Molded Case.
- ▶ Weight (lbs): 3.70



| Contents | Description | ASME Spec. | AS Spec. |
|----------|---|---------------|---------------|
| J5212 | Socket, 3/8" DR 3/8" 12 PT | ASME B107.1 | AS954E S3.8.1 |
| J5214 | Socket, 3/8" DR 7/16" 12 PT | ASME B107.1 | AS954E S3.8.1 |
| J5216 | Socket, 3/8" DR 1/2" 12 PT | ASME B107.1 | AS954E S3.8.1 |
| J5218 | Socket, 3/8" DR 9/16" 12 PT | ASME B107.1 | AS954E S3.8.1 |
| J5220 | Socket, 3/8" DR 5/8" 12 PT | ASME B107.1 | AS954E S3.8.1 |
| J5222 | Socket, 3/8" DR 11/16" 12 PT | ASME B107.1 | AS954E S3.8.1 |
| J5224 | Socket, 3/8" DR 3/4" 12 PT | ASME B107.1 | AS954E S3.8.1 |
| J5226 | Socket, 3/8" DR 13/16" 12 PT | ASME B107.1 | AS954E S3.8.1 |
| J5228 | Socket, 3/8" DR 7/8" 12 PT | ASME B107.1 | AS954E S3.8.1 |
| J5249 | Ratchet, 3/8" DR Standard Length Classic Pear Head 7" | ASME B107.500 | |
| J5260 | Extension, 3/8" DR 3" | ASME B107.500 | AS 4283 |
| J5260-06 | Extension, 3/8" DR 6" | ASME B107.500 | AS 4283 |
| JBM1103 | Blow-Molded Case | | |





3/8" DRIVE 12 PIECE SOCKET SET - 12 POINT

Product #: J52130XL

- › 12 Point Standard: 3/8, 7/16, 1/2, 9/16, 5/8, 11/16, 3/4, 13/16, 7/8 Inch.
- › Accessories: Premium Ratchet, 3 and 6 Inch Extensions, and Blow-Molded Case.
- › Weight (lbs): 4.00



| Contents | Description | ASME Spec. | AS Spec. |
|----------|---|---------------|---------------|
| J5212 | Socket, 3/8" DR 3/8" 12 PT | ASME B107.1 | AS954E S3.8.1 |
| J5214 | Socket, 3/8" DR 7/16" 12 PT | ASME B107.1 | AS954E S3.8.1 |
| J5216 | Socket, 3/8" DR 1/2" 12 PT | ASME B107.1 | AS954E S3.8.1 |
| J5218 | Socket, 3/8" DR 9/16" 12 PT | ASME B107.1 | AS954E S3.8.1 |
| J5220 | Socket, 3/8" DR 5/8" 12 PT | ASME B107.1 | AS954E S3.8.1 |
| J5222 | Socket, 3/8" DR 11/16" 12 PT | ASME B107.1 | AS954E S3.8.1 |
| J5224 | Socket, 3/8" DR 3/4" 12 PT | ASME B107.1 | AS954E S3.8.1 |
| J5226 | Socket, 3/8" DR 13/16" 12 PT | ASME B107.1 | AS954E S3.8.1 |
| J5228 | Socket, 3/8" DR 7/8" 12 PT | ASME B107.1 | AS954E S3.8.1 |
| J5249XL | Ratchet, 3/8" DR Standard Length Premium Pear Head 8-1/2" | ASME B107.500 | |
| J5260 | Extension, 3/8" DR 3" | ASME B107.500 | AS 4283 |
| J5260-06 | Extension, 3/8" DR 6" | ASME B107.500 | AS 4283 |
| JBM1103 | Blow-Molded Case | | |

3/8" DRIVE 21 PIECE METRIC SOCKET SET - 6 POINT

METRIC

Product #: J52211

- › 6 Point Standard: 6, 7, 8, 9, 10, 11, 12, 13, 14, 15, 16, 17, 18, 19, 20, 21, 22, 23, 24, 25, 26 mm.
- › Accessories: 9 and 11 Inch Socket Bars, and 21 Socket Clips.
- › Weight (lbs): 3.36



| Contents | Description | ASME Spec. |
|----------|----------------------------|--------------|
| J5206MH | Socket, 3/8" DR 6 mm 6 PT | ASME B107.5M |
| J5207MH | Socket, 3/8" DR 7 mm 6 PT | ASME B107.5M |
| J5208MH | Socket, 3/8" DR 8 mm 6 PT | ASME B107.5M |
| J5209MH | Socket, 3/8" DR 9 mm 6 PT | ASME B107.5M |
| J5210MH | Socket, 3/8" DR 10 mm 6 PT | ASME B107.5M |
| J5211MH | Socket, 3/8" DR 11 mm 6 PT | ASME B107.5M |
| J5212MH | Socket, 3/8" DR 12 mm 6 PT | ASME B107.5M |
| J5213MH | Socket, 3/8" DR 13 mm 6 PT | ASME B107.5M |
| J5214MH | Socket, 3/8" DR 14 mm 6 PT | ASME B107.5M |
| J5215MH | Socket, 3/8" DR 15 mm 6 PT | ASME B107.5M |
| J5216MH | Socket, 3/8" DR 16 mm 6 PT | ASME B107.5M |
| J5217MH | Socket, 3/8" DR 17 mm 6 PT | ASME B107.5M |
| J5218MH | Socket, 3/8" DR 18 mm 6 PT | ASME B107.5M |
| J5219MH | Socket, 3/8" DR 19 mm 6 PT | ASME B107.5M |
| J5220MH | Socket, 3/8" DR 20 mm 6 PT | ASME B107.5M |
| J5221MH | Socket, 3/8" DR 21 mm 6 PT | ASME B107.5M |
| J5222MH | Socket, 3/8" DR 22 mm 6 PT | ASME B107.5M |
| J5223MH | Socket, 3/8" DR 23 mm 6 PT | ASME B107.5M |
| J5224MH | Socket, 3/8" DR 24 mm 6 PT | ASME B107.5M |
| J5225MH | Socket, 3/8" DR 25 mm 6 PT | ASME B107.5M |
| J5226MH | Socket, 3/8" DR 26 mm 6 PT | ASME B107.5M |
| J2585 | Socket, Bar 9" | |
| J2588 | Socket, Bar 11" | |
| J2591 | Socket, Clip 3/8" DR | |



3/8" DRIVE 21 PIECE METRIC SOCKET SET - 12 POINT

METRIC



Product #: J52215

- ▶ 12 Point Standard: 6, 7, 8, 9, 10, 11, 12, 13, 14, 15, 16, 17, 18, 19, 20, 21, 22, 23, 24, 25, 26 mm.
- ▶ Accessories: 9 and 11 Inch Socket Bars, and 21 Socket Clips.
- ▶ Weight (lbs): 2.98



| Contents | Description | ASME Spec. | AS Spec. |
|----------|-----------------------------|--------------|---------------|
| J5206M | Socket, 3/8" DR 6 mm 12 PT | ASME B107.5M | AS954E S3.8.1 |
| J5207M | Socket, 3/8" DR 7 mm 12 PT | ASME B107.5M | AS954E S3.8.1 |
| J5208M | Socket, 3/8" DR 8 mm 12 PT | ASME B107.5M | AS954E S3.8.1 |
| J5209M | Socket, 3/8" DR 9 mm 12 PT | ASME B107.5M | AS954E S3.8.1 |
| J5210M | Socket, 3/8" DR 10 mm 12 PT | ASME B107.5M | AS954E S3.8.1 |
| J5211M | Socket, 3/8" DR 11 mm 12 PT | ASME B107.5M | AS954E S3.8.1 |
| J5212M | Socket, 3/8" DR 12 mm 12 PT | ASME B107.5M | AS954E S3.8.1 |
| J5213M | Socket, 3/8" DR 13 mm 12 PT | ASME B107.5M | AS954E S3.8.1 |
| J5214M | Socket, 3/8" DR 14 mm 12 PT | ASME B107.5M | AS954E S3.8.1 |
| J5215M | Socket, 3/8" DR 15 mm 12 PT | ASME B107.5M | AS954E S3.8.1 |
| J5216M | Socket, 3/8" DR 16 mm 12 PT | ASME B107.5M | AS954E S3.8.1 |
| J5217M | Socket, 3/8" DR 17 mm 12 PT | ASME B107.5M | AS954E S3.8.1 |
| J5218M | Socket, 3/8" DR 18 mm 12 PT | ASME B107.5M | AS954E S3.8.1 |
| J5219M | Socket, 3/8" DR 19 mm 12 PT | ASME B107.5M | AS954E S3.8.1 |
| J5220M | Socket, 3/8" DR 20 mm 12 PT | ASME B107.5M | AS954E S3.8.1 |
| J5221M | Socket, 3/8" DR 21 mm 12 PT | ASME B107.5M | AS954E S3.8.1 |
| J5222M | Socket, 3/8" DR 22 mm 12 PT | ASME B107.5M | AS954E S3.8.1 |
| J5223M | Socket, 3/8" DR 23 mm 12 PT | ASME B107.5M | AS954E S3.8.1 |
| J5224M | Socket, 3/8" DR 24 mm 12 PT | ASME B107.5M | AS954E S3.8.1 |
| J5225M | Socket, 3/8" DR 25 mm 12 PT | ASME B107.5M | AS954E S3.8.1 |
| J5226M | Socket, 3/8" DR 26 mm 12 PT | ASME B107.5M | AS954E S3.8.1 |
| J2585 | Socket, Bar 9" | | |
| J2588 | Socket, Bar 11" | | |
| J2591 | Socket, Clip 3/8" DR | | |





3/8" DRIVE 18 PIECE METRIC DEEP SOCKET SET - 12 POINT



Product #: J52207



- › 12 Point Deep: 6, 7, 8, 9, 10, 11, 12, 13, 14, 15, 16, 17, 18, 19, 20, 21, 22, 23 mm
- › Accessories: 17 Inch Socket Bar with 18 Socket Clips.
- › Weight (lbs): 4.55



| Contents | Description | ASME Spec. | AS Spec. |
|----------|----------------------------------|--------------|---------------|
| J5006M | Socket, 3/8" DR 6 mm 12 PT Deep | ASME B107.5M | AS954E S3.8.1 |
| J5007M | Socket, 3/8" DR 7 mm 12 PT Deep | ASME B107.5M | AS954E S3.8.1 |
| J5008M | Socket, 3/8" DR 8 mm 12 PT Deep | ASME B107.5M | AS954E S3.8.1 |
| J5009M | Socket, 3/8" DR 9 mm 12 PT Deep | ASME B107.5M | AS954E S3.8.1 |
| J5010M | Socket, 3/8" DR 10 mm 12 PT Deep | ASME B107.5M | AS954E S3.8.1 |
| J5011M | Socket, 3/8" DR 11 mm 12 PT Deep | ASME B107.5M | AS954E S3.8.1 |
| J5012M | Socket, 3/8" DR 12 mm 12 PT Deep | ASME B107.5M | AS954E S3.8.1 |
| J5013M | Socket, 3/8" DR 13 mm 12 PT Deep | ASME B107.5M | AS954E S3.8.1 |
| J5014M | Socket, 3/8" DR 14 mm 12 PT Deep | ASME B107.5M | AS954E S3.8.1 |
| J5015M | Socket, 3/8" DR 15 mm 12 PT Deep | ASME B107.5M | AS954E S3.8.1 |
| J5016M | Socket, 3/8" DR 16 mm 12 PT Deep | ASME B107.5M | AS954E S3.8.1 |
| J5017M | Socket, 3/8" DR 17 mm 12 PT Deep | ASME B107.5M | AS954E S3.8.1 |
| J5018M | Socket, 3/8" DR 18 mm 12 PT Deep | ASME B107.5M | AS954E S3.8.1 |
| J5019M | Socket, 3/8" DR 19 mm 12 PT Deep | ASME B107.5M | AS954E S3.8.1 |
| J5020M | Socket, 3/8" DR 20 mm 12 PT Deep | ASME B107.5M | AS954E S3.8.1 |
| J5021M | Socket, 3/8" DR 21 mm 12 PT Deep | ASME B107.5M | AS954E S3.8.1 |
| J5022M | Socket, 3/8" DR 22 mm 12 PT Deep | ASME B107.5M | AS954E S3.8.1 |
| J5023M | Socket, 3/8" DR 23 mm 12 PT Deep | ASME B107.5M | AS954E S3.8.1 |
| J2587 | Socket, Bar 17" | | |
| J2591 | Socket, Clip 3/8" DR | | |

3/8" DRIVE 18 PIECE METRIC DEEP SOCKET SET - 6 POINT



Product #: J52203



- › 6 Point Deep: 6, 7, 8, 9, 10, 11, 12, 13, 14, 15, 16, 17, 18, 19, 20, 21, 22, 23 mm
- › Accessories: 17 Inch Socket Bar with 18 Socket Clips.
- › Weight (lbs): 4.78



| Contents | Description | ASME Spec. |
|----------|---------------------------------|--------------|
| J5006MH | Socket, 3/8" DR 6 mm 6 PT Deep | ASME B107.5M |
| J5007MH | Socket, 3/8" DR 7 mm 6 PT Deep | ASME B107.5M |
| J5008MH | Socket, 3/8" DR 8 mm 6 PT Deep | ASME B107.5M |
| J5009MH | Socket, 3/8" DR 9 mm 6 PT Deep | ASME B107.5M |
| J5010MH | Socket, 3/8" DR 10 mm 6 PT Deep | ASME B107.5M |
| J5011MH | Socket, 3/8" DR 11 mm 6 PT Deep | ASME B107.5M |
| J5012MH | Socket, 3/8" DR 12 mm 6 PT Deep | ASME B107.5M |
| J5013MH | Socket, 3/8" DR 13 mm 6 PT Deep | ASME B107.5M |
| J5014MH | Socket, 3/8" DR 14 mm 6 PT Deep | ASME B107.5M |
| J5015MH | Socket, 3/8" DR 15 mm 6 PT Deep | ASME B107.5M |
| J5016MH | Socket, 3/8" DR 16 mm 6 PT Deep | ASME B107.5M |
| J5017MH | Socket, 3/8" DR 17 mm 6 PT Deep | ASME B107.5M |
| J5018MH | Socket, 3/8" DR 18 mm 6 PT Deep | ASME B107.5M |
| J5019MH | Socket, 3/8" DR 19 mm 6 PT Deep | ASME B107.5M |
| J5020MH | Socket, 3/8" DR 20 mm 6 PT Deep | ASME B107.5M |
| J5021MH | Socket, 3/8" DR 11 mm 6 PT Deep | ASME B107.5M |
| J5022MH | Socket, 3/8" DR 22 mm 6 PT Deep | ASME B107.5M |
| J5023MH | Socket, 3/8" DR 23 mm 6 PT Deep | ASME B107.5M |
| J2587 | Socket, Bar 17" | |
| J2591 | Socket, Clip 3/8" DR | |





3/8" DRIVE 13 PIECE SOCKET SET - 12 POINT

Product #: J52124



- ▶ 12 Point Standard: 1/4, 5/16, 3/8, 7/16, 1/2, 9/16, 5/8, 11/16, 3/4, 13/16, 7/8, 15/16, 1 Inch
- ▶ Accessories: 13 Inch Socket Bar with 13 Socket Clips.
- ▶ Weight (lbs): 1.96



| Contents | Description | ASME Spec. | AS Spec. |
|----------|------------------------------|-------------|---------------|
| J5208 | Socket, 3/8" DR 1/4" 12 PT | ASME B107.1 | AS954E S3.8.1 |
| J5210 | Socket, 3/8" DR 5/16" 12 PT | ASME B107.1 | AS954E S3.8.1 |
| J5212 | Socket, 3/8" DR 3/8" 12 PT | ASME B107.1 | AS954E S3.8.1 |
| J5214 | Socket, 3/8" DR 7/16" 12 PT | ASME B107.1 | AS954E S3.8.1 |
| J5216 | Socket, 3/8" DR 1/2" 12 PT | ASME B107.1 | AS954E S3.8.1 |
| J5218 | Socket, 3/8" DR 9/16" 12 PT | ASME B107.1 | AS954E S3.8.1 |
| J5220 | Socket, 3/8" DR 5/8" 12 PT | ASME B107.1 | AS954E S3.8.1 |
| J5222 | Socket, 3/8" DR 11/16" 12 PT | ASME B107.1 | AS954E S3.8.1 |
| J5224 | Socket, 3/8" DR 3/4" 12 PT | ASME B107.1 | AS954E S3.8.1 |
| J5226 | Socket, 3/8" DR 13/16" 12 PT | ASME B107.1 | AS954E S3.8.1 |
| J5228 | Socket, 3/8" DR 7/8" 12 PT | ASME B107.1 | AS954E S3.8.1 |
| J5230 | Socket, 3/8" DR 15/16" 12 PT | ASME B107.1 | AS954E S3.8.1 |
| J5232 | Socket, 3/8" DR 1" 12 PT | ASME B107.1 | AS954E S3.8.1 |
| J2586 | Socket, Bar 13" | | |
| J2591 | Socket, Clip 3/8" DR | | |

3/8" DRIVE 13 PIECE SOCKET SET - 6 POINT

Product #: J52126



- ▶ 6 Point Standard: 1/4, 5/16, 3/8, 7/16, 1/2, 9/16, 5/8, 11/16, 3/4, 13/16, 7/8, 15/16, 1 Inch
- ▶ Accessories: 13 Inch Socket Bar with 13 Socket Clips.
- ▶ Weight (lbs): 2.10



| Contents | Description | ASME Spec. |
|----------|-----------------------------|-------------|
| J5208H | Socket, 3/8" DR 1/4" 6 PT | ASME B107.1 |
| J5210H | Socket, 3/8" DR 5/16" 6 PT | ASME B107.1 |
| J5212H | Socket, 3/8" DR 3/8" 6 PT | ASME B107.1 |
| J5214H | Socket, 3/8" DR 7/16" 6 PT | ASME B107.1 |
| J5216H | Socket, 3/8" DR 1/2" 6 PT | ASME B107.1 |
| J5218H | Socket, 3/8" DR 9/16" 6 PT | ASME B107.1 |
| J5220H | Socket, 3/8" DR 5/8" 6 PT | ASME B107.1 |
| J5222H | Socket, 3/8" DR 11/16" 6 PT | ASME B107.1 |
| J5224H | Socket, 3/8" DR 3/4" 6 PT | ASME B107.1 |
| J5226H | Socket, 3/8" DR 13/16" 6 PT | ASME B107.1 |
| J5228H | Socket, 3/8" DR 7/8" 6 PT | ASME B107.1 |
| J5230H | Socket, 3/8" DR 15/16" 6 PT | ASME B107.1 |
| J5232H | Socket, 3/8" DR 1" 6 PT | ASME B107.1 |
| J2586 | Socket, Bar 13" | |
| J2591 | Socket, Clip 3/8" DR | |



3/8" DRIVE 13 PIECE DEEP SOCKET SET - 6 POINT

Product #: J52114

- › 6 Point Deep: 1/4, 5/16, 3/8, 7/16, 1/2, 9/16, 5/8, 11/16, 3/4, 13/16, 7/8, 15/16, 1 Inch.
- › Accessories: 13 Inch Socket Bar with 13 Socket Clips.
- › Weight (lbs): 3.73



| Contents | Description | ASME Spec. |
|----------|----------------------------------|-------------|
| J5008H | Socket, 3/8" DR 1/4" 6 PT Deep | ASME B107.1 |
| J5010H | Socket, 3/8" DR 5/16" 6 PT Deep | ASME B107.1 |
| J5012H | Socket, 3/8" DR 3/8" 6 PT Deep | ASME B107.1 |
| J5014H | Socket, 3/8" DR 7/16" 6 PT Deep | ASME B107.1 |
| J5016H | Socket, 3/8" DR 1/2" 6 PT Deep | ASME B107.1 |
| J5018H | Socket, 3/8" DR 9/16" 6 PT Deep | ASME B107.1 |
| J5020H | Socket, 3/8" DR 5/8" 6 PT Deep | ASME B107.1 |
| J5022H | Socket, 3/8" DR 11/16" 6 PT Deep | ASME B107.1 |
| J5024H | Socket, 3/8" DR 3/4" 6 PT Deep | ASME B107.1 |
| J5026H | Socket, 3/8" DR 13/16" 6 PT Deep | ASME B107.1 |
| J5028H | Socket, 3/8" DR 7/8" 6 PT Deep | ASME B107.1 |
| J5030H | Socket, 3/8" DR 15/16" 6 PT Deep | ASME B107.1 |
| J5032H | Socket, 3/8" DR 1" 6 PT Deep | ASME B107.1 |
| J2586 | Socket, Bar 13" | |
| J2591 | Socket, Clip 3/8" DR | |

3/8" DRIVE 13 PIECE DEEP SOCKET SET - 12 POINT

Product #: J52112

- › 12 Point Deep: 1/4, 5/16, 3/8, 7/16, 1/2, 9/16, 5/8, 11/16, 3/4, 13/16, 7/8, 15/16, 1 Inch.
- › Accessories: 13 Inch Socket Bar with 13 Socket Clips.
- › Weight (lbs): 3.64



| Contents | Description | ASME Spec. | AS Spec. |
|----------|-----------------------------------|-------------|---------------|
| J5008 | Socket, 3/8" DR 1/4" 12 PT Deep | ASME B107.1 | AS954E S3.8.1 |
| J5010 | Socket, 3/8" DR 5/16" 12 PT Deep | ASME B107.1 | AS954E S3.8.1 |
| J5012 | Socket, 3/8" DR 3/8" 12 PT Deep | ASME B107.1 | AS954E S3.8.1 |
| J5014 | Socket, 3/8" DR 7/16" 12 PT Deep | ASME B107.1 | AS954E S3.8.1 |
| J5016 | Socket, 3/8" DR 1/2" 12 PT Deep | ASME B107.1 | AS954E S3.8.1 |
| J5018 | Socket, 3/8" DR 9/16" 12 PT Deep | ASME B107.1 | AS954E S3.8.1 |
| J5020 | Socket, 3/8" DR 5/8" 12 PT Deep | ASME B107.1 | AS954E S3.8.1 |
| J5022 | Socket, 3/8" DR 11/16" 12 PT Deep | ASME B107.1 | AS954E S3.8.1 |
| J5024 | Socket, 3/8" DR 3/4" 12 PT Deep | ASME B107.1 | AS954E S3.8.1 |
| J5026 | Socket, 3/8" DR 13/16" 12 PT Deep | ASME B107.1 | AS954E S3.8.1 |
| J5028 | Socket, 3/8" DR 7/8" 12 PT Deep | ASME B107.1 | AS954E S3.8.1 |
| J5030 | Socket, 3/8" DR 15/16" 12 PT Deep | ASME B107.1 | AS954E S3.8.1 |
| J5032 | Socket, 3/8" DR 1" 12 PT Deep | ASME B107.1 | AS954E S3.8.1 |
| J2586 | Socket, Bar 13" | | |
| J2591 | Socket, Clip 3/8" DR | | |



3/8" DRIVE 12 PIECE METRIC SOCKET SET - 6 POINT

METRIC

Product #: J52212

- ▶ 6 Point Standard: 8, 9, 10, 11, 12, 13, 14, 15, 16, 17, 18, 19 mm.
- ▶ Accessories: 13 Inch Socket Bar with 12 Socket Clips.
- ▶ Weight (lbs): 1.35



| Contents | Description | ASME Spec. |
|----------|----------------------------|--------------|
| J5208MH | Socket, 3/8" DR 8 mm 6 PT | ASME B107.5M |
| J5209MH | Socket, 3/8" DR 9 mm 6 PT | ASME B107.5M |
| J5210MH | Socket, 3/8" DR 10 mm 6 PT | ASME B107.5M |
| J5211MH | Socket, 3/8" DR 11 mm 6 PT | ASME B107.5M |
| J5212MH | Socket, 3/8" DR 12 mm 6 PT | ASME B107.5M |
| J5213MH | Socket, 3/8" DR 13 mm 6 PT | ASME B107.5M |
| J5214MH | Socket, 3/8" DR 14 mm 6 PT | ASME B107.5M |
| J5215MH | Socket, 3/8" DR 15 mm 6 PT | ASME B107.5M |
| J5216MH | Socket, 3/8" DR 16 mm 6 PT | ASME B107.5M |
| J5217MH | Socket, 3/8" DR 17 mm 6 PT | ASME B107.5M |
| J5218MH | Socket, 3/8" DR 18 mm 6 PT | ASME B107.5M |
| J5219MH | Socket, 3/8" DR 19 mm 6 PT | ASME B107.5M |
| J2586 | Socket, Bar 13" | |
| J2591 | Socket, Clip 3/8" DR | |

3/8" DRIVE 12 PIECE METRIC SOCKET SET - 12 POINT

METRIC

Product #: J52216

- ▶ 12 Point Standard: 8, 9, 10, 11, 12, 13, 14, 15, 16, 17, 18, 19 mm.
- ▶ Accessories: 13 Inch Socket Bar with 12 Socket Clips.
- ▶ Weight (lbs): 1.32



| Contents | Description | ASME Spec. | AS Spec. |
|----------|-----------------------------|--------------|---------------|
| J5208M | Socket, 3/8" DR 8 mm 12 PT | ASME B107.5M | AS954E S3.8.1 |
| J5209M | Socket, 3/8" DR 9 mm 12 PT | ASME B107.5M | AS954E S3.8.1 |
| J5210M | Socket, 3/8" DR 10 mm 12 PT | ASME B107.5M | AS954E S3.8.1 |
| J5211M | Socket, 3/8" DR 11 mm 12 PT | ASME B107.5M | AS954E S3.8.1 |
| J5212M | Socket, 3/8" DR 12 mm 12 PT | ASME B107.5M | AS954E S3.8.1 |
| J5213M | Socket, 3/8" DR 13 mm 12 PT | ASME B107.5M | AS954E S3.8.1 |
| J5214M | Socket, 3/8" DR 14 mm 12 PT | ASME B107.5M | AS954E S3.8.1 |
| J5215M | Socket, 3/8" DR 15 mm 12 PT | ASME B107.5M | AS954E S3.8.1 |
| J5216M | Socket, 3/8" DR 16 mm 12 PT | ASME B107.5M | AS954E S3.8.1 |
| J5217M | Socket, 3/8" DR 17 mm 12 PT | ASME B107.5M | AS954E S3.8.1 |
| J5218M | Socket, 3/8" DR 18 mm 12 PT | ASME B107.5M | AS954E S3.8.1 |
| J5219M | Socket, 3/8" DR 19 mm 12 PT | ASME B107.5M | AS954E S3.8.1 |
| J2586 | Socket, Bar 13" | | |
| J2591 | Socket, Clip 3/8" DR | | |





3/8" DRIVE 12 PIECE METRIC DEEP SOCKET SET - 12 POINT

METRIC

Product #: J52209

- › 12 Point Deep: 8, 9, 10, 11, 12, 13, 14, 15, 16, 17, 18, 19 mm.
- › Accessories: 13 Inch Socket Bar with 12 Socket Clips.
- › Weight (lbs): 2.52



| Contents | Description | ASME Spec. | AS Spec. |
|----------|----------------------------------|--------------|---------------|
| J5008M | Socket, 3/8" DR 8 mm 12 PT Deep | ASME B107.5M | AS954E S3.8.1 |
| J5009M | Socket, 3/8" DR 9 mm 12 PT Deep | ASME B107.5M | AS954E S3.8.1 |
| J5010M | Socket, 3/8" DR 10 mm 12 PT Deep | ASME B107.5M | AS954E S3.8.1 |
| J5011M | Socket, 3/8" DR 11 mm 12 PT Deep | ASME B107.5M | AS954E S3.8.1 |
| J5012M | Socket, 3/8" DR 12 mm 12 PT Deep | ASME B107.5M | AS954E S3.8.1 |
| J5013M | Socket, 3/8" DR 13 mm 12 PT Deep | ASME B107.5M | AS954E S3.8.1 |
| J5014M | Socket, 3/8" DR 14 mm 12 PT Deep | ASME B107.5M | AS954E S3.8.1 |
| J5015M | Socket, 3/8" DR 15 mm 12 PT Deep | ASME B107.5M | AS954E S3.8.1 |
| J5016M | Socket, 3/8" DR 16 mm 12 PT Deep | ASME B107.5M | AS954E S3.8.1 |
| J5017M | Socket, 3/8" DR 17 mm 12 PT Deep | ASME B107.5M | AS954E S3.8.1 |
| J5018M | Socket, 3/8" DR 18 mm 12 PT Deep | ASME B107.5M | AS954E S3.8.1 |
| J5019M | Socket, 3/8" DR 19 mm 12 PT Deep | ASME B107.5M | AS954E S3.8.1 |
| J2586 | Socket, Bar 13" | | |
| J2591 | Socket, Clip 3/8" DR | | |

3/8" DRIVE 12 PIECE METRIC DEEP SOCKET SET - 6 POINT

METRIC

Product #: J52205

- › 6 Point Deep: 8, 9, 10, 11, 12, 13, 14, 15, 16, 17, 18, 19 mm.
- › Accessories: 13 Inch Socket Bar with 12 Socket Clips.
- › Weight (lbs): 2.62



| Contents | Description | ASME Spec. |
|----------|---------------------------------|--------------|
| J5008MH | Socket, 3/8" DR 8 mm 6 PT Deep | ASME B107.5M |
| J5009MH | Socket, 3/8" DR 9 mm 6 PT Deep | ASME B107.5M |
| J5010MH | Socket, 3/8" DR 10 mm 6 PT Deep | ASME B107.5M |
| J5011MH | Socket, 3/8" DR 11 mm 6 PT Deep | ASME B107.5M |
| J5012MH | Socket, 3/8" DR 12 mm 6 PT Deep | ASME B107.5M |
| J5013MH | Socket, 3/8" DR 13 mm 6 PT Deep | ASME B107.5M |
| J5014MH | Socket, 3/8" DR 14 mm 6 PT Deep | ASME B107.5M |
| J5015MH | Socket, 3/8" DR 15 mm 6 PT Deep | ASME B107.5M |
| J5016MH | Socket, 3/8" DR 16 mm 6 PT Deep | ASME B107.5M |
| J5017MH | Socket, 3/8" DR 17 mm 6 PT Deep | ASME B107.5M |
| J5018MH | Socket, 3/8" DR 18 mm 6 PT Deep | ASME B107.5M |
| J5019MH | Socket, 3/8" DR 19 mm 6 PT Deep | ASME B107.5M |
| J2586 | Socket, Bar 13" | |
| J2591 | Socket, Clip 3/8" DR | |





3/8" DRIVE 10 PIECE SOCKET SET - 6 POINT

Product #: J52122

- ▶ 6 Point Standard: 5/16, 3/8, 7/16, 1/2, 9/16, 5/8, 11/16, 3/4, 13/16, 7/8 Inch.
- ▶ Accessories: 9 Inch Socket Bar, 10 Socket Clips.
- ▶ Weight (lbs): 1.34



| Contents | Description | ASME Spec. |
|----------|-----------------------------|-------------|
| J5210H | Socket, 3/8" DR 5/16" 6 PT | ASME B107.1 |
| J5212H | Socket, 3/8" DR 3/8" 6 PT | ASME B107.1 |
| J5214H | Socket, 3/8" DR 7/16" 6 PT | ASME B107.1 |
| J5216H | Socket, 3/8" DR 1/2" 6 PT | ASME B107.1 |
| J5218H | Socket, 3/8" DR 9/16" 6 PT | ASME B107.1 |
| J5220H | Socket, 3/8" DR 5/8" 6 PT | ASME B107.1 |
| J5222H | Socket, 3/8" DR 11/16" 6 PT | ASME B107.1 |
| J5224H | Socket, 3/8" DR 3/4" 6 PT | ASME B107.1 |
| J5226H | Socket, 3/8" DR 13/16" 6 PT | ASME B107.1 |
| J5228H | Socket, 3/8" DR 7/8" 6 PT | ASME B107.1 |
| J2585 | Socket, Bar 9" | |
| J2591 | Socket, Clip 3/8" DR | |

3/8" DRIVE 10 PIECE SOCKET SET - 12 POINT

Product #: J52118

- ▶ 12 Point Standard: 5/16, 3/8, 7/16, 1/2, 9/16, 5/8, 11/16, 3/4, 13/16, 7/8 Inch.
- ▶ Accessories: 9 Inch Socket Bar, 10 Socket Clips.
- ▶ Weight (lbs): 1.30



| Contents | Description | ASME Spec. | AS Spec. |
|----------|------------------------------|-------------|---------------|
| J5210 | Socket, 3/8" DR 5/16" 12 PT | ASME B107.1 | AS954E S3.8.1 |
| J5212 | Socket, 3/8" DR 3/8" 12 PT | ASME B107.1 | AS954E S3.8.1 |
| J5214 | Socket, 3/8" DR 7/16" 12 PT | ASME B107.1 | AS954E S3.8.1 |
| J5216 | Socket, 3/8" DR 1/2" 12 PT | ASME B107.1 | AS954E S3.8.1 |
| J5218 | Socket, 3/8" DR 9/16" 12 PT | ASME B107.1 | AS954E S3.8.1 |
| J5220 | Socket, 3/8" DR 5/8" 12 PT | ASME B107.1 | AS954E S3.8.1 |
| J5222 | Socket, 3/8" DR 11/16" 12 PT | ASME B107.1 | AS954E S3.8.1 |
| J5224 | Socket, 3/8" DR 3/4" 12 PT | ASME B107.1 | AS954E S3.8.1 |
| J5226 | Socket, 3/8" DR 13/16" 12 PT | ASME B107.1 | AS954E S3.8.1 |
| J5228 | Socket, 3/8" DR 7/8" 12 PT | ASME B107.1 | AS954E S3.8.1 |
| J2585 | Socket, Bar 9" | | |
| J2591 | Socket, Clip 3/8" DR | | |



3/8" DRIVE 10 PIECE DEEP SOCKET SET - 6 POINT

Product #: J52111

- › 6 Point Deep: 5/16, 3/8, 7/16, 1/2, 9/16, 5/8, 11/16, 3/4, 13/16, 7/8 Inch.
- › Accessories: 9 Inch Socket Bar with 10 Socket Clips.
- › Weight (lbs): 2.51



| Contents | Description | ASME Spec. |
|----------|----------------------------------|-------------|
| J5010H | Socket, 3/8" DR 5/16" 6 PT Deep | ASME B107.1 |
| J5012H | Socket, 3/8" DR 3/8" 6 PT Deep | ASME B107.1 |
| J5014H | Socket, 3/8" DR 7/16" 6 PT Deep | ASME B107.1 |
| J5016H | Socket, 3/8" DR 1/2" 6 PT Deep | ASME B107.1 |
| J5018H | Socket, 3/8" DR 9/16" 6 PT Deep | ASME B107.1 |
| J5020H | Socket, 3/8" DR 5/8" 6 PT Deep | ASME B107.1 |
| J5022H | Socket, 3/8" DR 11/16" 6 PT Deep | ASME B107.1 |
| J5024H | Socket, 3/8" DR 3/4" 6 PT Deep | ASME B107.1 |
| J5026H | Socket, 3/8" DR 13/16" 6 PT Deep | ASME B107.1 |
| J5028H | Socket, 3/8" DR 7/8" 6 PT Deep | ASME B107.1 |
| J2585 | Socket, Bar 9" | |
| J2591 | Socket, Clip 3/8" DR | |

3/8" DRIVE 10 PIECE DEEP SOCKET SET - 12 POINT

Product #: J52107

- › 12 Point Deep: 5/16, 3/8, 7/16, 1/2, 9/16, 5/8, 11/16, 3/4, 13/16, 7/8 Inch.
- › Accessories: 9 Inch Socket Bar with 10 Socket Clips.
- › Weight (lbs): 2.43



| Contents | Description | ASME Spec. | AS Spec. |
|----------|-----------------------------------|-------------|---------------|
| J5010 | Socket, 3/8" DR 5/16" 12 PT Deep | ASME B107.1 | AS954E S3.8.1 |
| J5012 | Socket, 3/8" DR 3/8" 12 PT Deep | ASME B107.1 | AS954E S3.8.1 |
| J5014 | Socket, 3/8" DR 7/16" 12 PT Deep | ASME B107.1 | AS954E S3.8.1 |
| J5016 | Socket, 3/8" DR 1/2" 12 PT Deep | ASME B107.1 | AS954E S3.8.1 |
| J5018 | Socket, 3/8" DR 9/16" 12 PT Deep | ASME B107.1 | AS954E S3.8.1 |
| J5020 | Socket, 3/8" DR 5/8" 12 PT Deep | ASME B107.1 | AS954E S3.8.1 |
| J5022 | Socket, 3/8" DR 11/16" 12 PT Deep | ASME B107.1 | AS954E S3.8.1 |
| J5024 | Socket, 3/8" DR 3/4" 12 PT Deep | ASME B107.1 | AS954E S3.8.1 |
| J5026 | Socket, 3/8" DR 13/16" 12 PT Deep | ASME B107.1 | AS954E S3.8.1 |
| J5028 | Socket, 3/8" DR 7/8" 12 PT Deep | ASME B107.1 | AS954E S3.8.1 |
| J2585 | Socket, Bar 9" | | |
| J2591 | Socket, Clip 3/8" DR | | |





3/8" DRIVE 10 PIECE SUPER SHORT SOCKET SET - 6 POINT

Product #: J52123



| Contents | Description |
|----------|---|
| J5206HS | Socket, 3/8" DR 3/16" 6 PT Super Short |
| J5208HS | Socket, 3/8" DR 1/4" 6 PT Super Short |
| J5210HS | Socket, 3/8" DR 5/16" 6 PT Super Short |
| J5212HS | Socket, 3/8" DR 3/8" 6 PT Super Short |
| J5214HS | Socket, 3/8" DR 7/16" 6 PT Super Short |
| J5216HS | Socket, 3/8" DR 1/2" 6 PT Super Short |
| J5218HS | Socket, 3/8" DR 9/16" 6 PT Super Short |
| J5220HS | Socket, 3/8" DR 5/8" 6 PT Super Short |
| J5222HS | Socket, 3/8" DR 11/16" 6 PT Super Short |
| J5224HS | Socket, 3/8" DR 3/4" 6 PT Super Short |
| J2585 | Socket, Bar 9" |
| J2591 | Socket, Clip 3/8" DR |



- › 6 Point Super Short: 3/16, 1/4, 5/16, 3/8, 7/16, 1/2, 9/16, 5/8, 11/16, 3/4 Inch.
- › Accessories: 9 Inch Socket Bar with 10 Socket Clips.
- › Weight (lbs): 0.82

3/8" DRIVE 13 PIECE BLACK OXIDE SOCKET SET - 12 POINT

Product #: J52304



- › 12 Point: 1/4, 5/16, 3/8, 7/16, 1/2, 9/16, 5/8, 11/16, 3/4, 13/16, 7/8, 15/16, 1 Inch.
- › Weight (lbs): 1.93



| Contents | Description | ASME Spec. | AS Spec. |
|----------|--|-------------|---------------|
| J5208B | Socket, 3/8" DR 1/4" 12 PT Black Oxide | ASME B107.1 | AS954E S3.8.1 |
| J5210B | Socket, 3/8" DR 5/16" 12 PT Black Oxide | ASME B107.1 | AS954E S3.8.1 |
| J5212B | Socket, 3/8" DR 3/8" 12 PT Black Oxide | ASME B107.1 | AS954E S3.8.1 |
| J5214B | Socket, 3/8" DR 7/16" 12 PT Black Oxide | ASME B107.1 | AS954E S3.8.1 |
| J5216B | Socket, 3/8" DR 1/2" 12 PT Black Oxide | ASME B107.1 | AS954E S3.8.1 |
| J5218B | Socket, 3/8" DR 9/16" 12 PT Black Oxide | ASME B107.1 | AS954E S3.8.1 |
| J5220B | Socket, 3/8" DR 5/8" 12 PT Black Oxide | ASME B107.1 | AS954E S3.8.1 |
| J5222B | Socket, 3/8" DR 11/16" 12 PT Black Oxide | ASME B107.1 | AS954E S3.8.1 |
| J5224B | Socket, 3/8" DR 3/4" 12 PT Black Oxide | ASME B107.1 | AS954E S3.8.1 |
| J5226B | Socket, 3/8" DR 13/16" 12 PT Black Oxide | ASME B107.1 | AS954E S3.8.1 |
| J5228B | Socket, 3/8" DR 7/8" 12 PT Black Oxide | ASME B107.1 | AS954E S3.8.1 |
| J5230B | Socket, 3/8" DR 15/16" 12 PT Black Oxide | ASME B107.1 | AS954E S3.8.1 |
| J5232B | Socket, 3/8" DR 1" 12 PT Black Oxide | ASME B107.1 | AS954E S3.8.1 |
| J2586 | Socket, Bar 13" | | |
| J2591 | Socket, Clip 3/8" DR | | |



3/8" DRIVE 10 PIECE METRIC UNIVERSAL SOCKET SET - 6 POINT

METRIC

Product #: J52201

- › 6 Point Universal: 10, 11, 12, 13, 14, 15, 16, 17, 18, 19 mm.
- › Accessories: 9 Inch Socket Bar with 10 Socket Clips.
- › Weight (lbs): 1.36



| Contents | Description | ASME Spec. |
|----------|--------------------------------------|--------------|
| J5273HAM | Socket, 3/8" DR Universal 10 mm 6 PT | ASME B107.5M |
| J5274HAM | Socket, 3/8" DR Universal 11 mm 6 PT | ASME B107.5M |
| J5275HAM | Socket, 3/8" DR Universal 12 mm 6 PT | ASME B107.5M |
| J5276HAM | Socket, 3/8" DR Universal 13 mm 6 PT | ASME B107.5M |
| J5277HAM | Socket, 3/8" DR Universal 14 mm 6 PT | ASME B107.5M |
| J5278HAM | Socket, 3/8" DR Universal 15 mm 6 PT | ASME B107.5M |
| J5279HAM | Socket, 3/8" DR Universal 16 mm 6 PT | ASME B107.5M |
| J5280HAM | Socket, 3/8" DR Universal 17 mm 6 PT | ASME B107.5M |
| J5281HAM | Socket, 3/8" DR Universal 18 mm 6 PT | ASME B107.5M |
| J5282HAM | Socket, 3/8" DR Universal 19 mm 6 PT | ASME B107.5M |
| J2585 | Socket, Bar 9" | |
| J2591 | Socket, Clip 3/8" DR | |

3/8" DRIVE 7 PIECE UNIVERSAL SOCKET SET - 12 POINT

Product #: J52102

- › 12 Point Universal 3/8, 7/16, 1/2, 9/16, 5/8, 11/16, 3/4 Inch.
- › Accessories: 6-1/4 Inch Socket Bar with 7 Socket Clips.
- › Weight (lbs): 0.94



| Contents | Description | ASME Spec. | AS Spec. |
|----------|--|-------------|---------------|
| J5273A | Socket, 3/8" DR Universal 3/8" 12 PT | ASME B107.1 | AS954E S3.8.1 |
| J5274A | Socket, 3/8" DR Universal 7/16" 12 PT | ASME B107.1 | AS954E S3.8.1 |
| J5275A | Socket, 3/8" DR Universal 1/2" 12 PT | ASME B107.1 | AS954E S3.8.1 |
| J5276A | Socket, 3/8" DR Universal 9/16" 12 PT | ASME B107.1 | AS954E S3.8.1 |
| J5277A | Socket, 3/8" DR Universal 5/8" 12 PT | ASME B107.1 | AS954E S3.8.1 |
| J5278A | Socket, 3/8" DR Universal 11/16" 12 PT | ASME B107.1 | AS954E S3.8.1 |
| J5279A | Socket, 3/8" DR Universal 3/4" 12 PT | ASME B107.1 | AS954E S3.8.1 |
| J2584 | Socket, Bar 6-1/4" | | |
| J2591 | Socket, Clip 3/8" DR | | |

3/8" DRIVE 7 PIECE METRIC UNIVERSAL SOCKET SET - 12 POINT

METRIC

Product #: J52200

- › 12 Point Standard: 9, 10, 11, 12, 13, 14, 15 mm.
- › Accessories: 6-1/4 Inch Socket Bar, 7 Socket Clips.
- › Weight (lbs): 0.92



| Contents | Description | ASME Spec. |
|----------|---------------------------------------|--------------|
| J5272AM | Socket, 3/8" DR Universal 9 mm 12 PT | ASME B107.5M |
| J5273AM | Socket, 3/8" DR Universal 10 mm 12 PT | ASME B107.5M |
| J5274AM | Socket, 3/8" DR Universal 11 mm 12 PT | ASME B107.5M |
| J5275AM | Socket, 3/8" DR Universal 12 mm 12 PT | ASME B107.5M |
| J5276AM | Socket, 3/8" DR Universal 13 mm 12 PT | ASME B107.5M |
| J5277AM | Socket, 3/8" DR Universal 14 mm 12 PT | ASME B107.5M |
| J5278AM | Socket, 3/8" DR Universal 15 mm 12 PT | ASME B107.5M |
| J2584 | Socket, Bar 6-1/4" | |
| J2591 | Socket, Clip 3/8" DR | |





3/8" DRIVE 7 PIECE UNIVERSAL SOCKET SET - 6 POINT

Product #: J52100

- › 6 Point Standard: 3/8, 7/16, 1/2, 9/16, 5/8, 11/16, 3/4 Inch.
- › Accessories: 6-1/4 Inch Socket Bar with 7 Socket Clips.
- › Weight (lbs): 0.97



| Contents | Description | ASME Spec. |
|----------|---------------------------------------|-------------|
| J5273HA | Socket, 3/8" DR Universal 3/8" 6 PT | ASME B107.1 |
| J5274HA | Socket, 3/8" DR Universal 7/16" 6 PT | ASME B107.1 |
| J5275HA | Socket, 3/8" DR Universal 1/2" 6 PT | ASME B107.1 |
| J5276HA | Socket, 3/8" DR Universal 9/16" 6 PT | ASME B107.1 |
| J5277HA | Socket, 3/8" DR Universal 5/8" 6 PT | ASME B107.1 |
| J5278HA | Socket, 3/8" DR Universal 11/16" 6 PT | ASME B107.1 |
| J5279HA | Socket, 3/8" DR Universal 3/4" 6 PT | ASME B107.1 |
| J2584 | Socket, Bar 6-1/4" | |
| J2591 | Socket, Clip 3/8" DR | |

3/8" & 1/2" DRIVE 10 PIECE HEX BIT SET

Product #: J4900A

| Contents | Description |
|-----------|-------------------------------|
| J49901/8 | Socket, Hex Bit 3/8" DR 1/8" |
| J49905/32 | Socket, Hex Bit 3/8" DR 5/32" |
| J49903/16 | Socket, Hex Bit 3/8" DR 3/16" |
| J49907/32 | Socket, Hex Bit 3/8" DR 7/32" |
| J49901/4 | Socket, Hex Bit 3/8" DR 1/4" |
| J49905/16 | Socket, Hex Bit 3/8" DR 5/16" |
| J49903/8 | Socket, Hex Bit 3/8" DR 3/8" |
| J54411/2 | Socket, Hex Bit 1/2" DR 1/2" |
| J54419/16 | Socket, Hex Bit 1/2" DR 9/16" |
| J54415/8 | Socket, Hex Bit 1/2" DR 5/8" |
| J4968PB | Blow-Molded Case |



- › 3/8 Inch Drive: 1/8, 5/32, 3/16, 7/32, 1/4, 5/16, 3/8 Inch.
- › 1/2 Inch Drive: 1/2, 9/16, 5/8 Inch.
- › Blow-Molded Case.
- › Weight (lbs): 3.15

3/8" & 1/2" DRIVE 10 PIECE METRIC HEX BIT SET

Product #: J4900MA

| Contents | Description |
|-----------|-------------------------------|
| J4990-4M | Socket, Hex Bit 3/8" DR 4 mm |
| J4990-5M | Socket, Hex Bit 3/8" DR 5 mm |
| J4990-6M | Socket, Hex Bit 3/8" DR 6 mm |
| J4990-7M | Socket, Hex Bit 3/8" DR 7 mm |
| J4990-8M | Socket, Hex Bit 3/8" DR 8 mm |
| J4990-9M | Socket, Hex Bit 3/8" DR 9 mm |
| J4990-10M | Socket, Hex Bit 3/8" DR 10 mm |
| J5441-12M | Socket, Hex Bit 1/2" DR 12 mm |
| J5441-14M | Socket, Hex Bit 1/2" DR 14 mm |
| J5441-17M | Socket, Hex Bit 3/8" DR 17 mm |
| J4968PB | Blow-Molded Case |

METRIC



- › 3/8 Inch Drive: 4, 5, 6, 7, 8, 9, 10.
- › 1/2 Inch Drive: 12, 14, 17 mm.
- › Blow-Molded Case.
- › Weight (lbs): 3.11



3/8" & 1/2" DRIVE 10 PIECE HEX BIT SET

Product #: J4900AC



| Contents | Description |
|-----------|-------------------------------|
| J49901/8 | Socket, Hex Bit 3/8" DR 1/8" |
| J49905/32 | Socket, Hex Bit 3/8" DR 5/32" |
| J49903/16 | Socket, Hex Bit 3/8" DR 3/16" |
| J49907/32 | Socket, Hex Bit 3/8" DR 7/32" |
| J49901/4 | Socket, Hex Bit 3/8" DR 1/4" |
| J49905/16 | Socket, Hex Bit 3/8" DR 5/16" |
| J49903/8 | Socket, Hex Bit 3/8" DR 3/8" |
| J54411/2 | Socket, Hex Bit 1/2" DR 1/2" |
| J54419/16 | Socket, Hex Bit 1/2" DR 9/16" |
| J54415/8 | Socket, Hex Bit 1/2" DR 5/8" |
| J2585 | Socket, Bar 9" |
| J2591 | Socket, Clip 3/8" DR |
| J2592 | Socket, Clip |



- ▶ 3/8 Inch Drive: 1/8, 5/32, 3/16, 7/32, 1/4, 5/16, 3/8 Inch.
- ▶ 1/2 Inch Drive: 1/2, 9/16, 5/8 Inch.
- ▶ Accessories 9 Inch Socket Bar with 10 Socket Clips.
- ▶ Weight (lbs): 2.91

3/8" DRIVE 7 PIECE HEX BIT SET

Product #: J4900-7C



| Contents | Description |
|-----------|-------------------------------|
| J49901/8 | Socket, Hex Bit 3/8" DR 1/8" |
| J49905/32 | Socket, Hex Bit 3/8" DR 5/32" |
| J49903/16 | Socket, Hex Bit 3/8" DR 3/16" |
| J49907/32 | Socket, Hex Bit 3/8" DR 7/32" |
| J49901/4 | Socket, Hex Bit 3/8" DR 1/4" |
| J49905/16 | Socket, Hex Bit 3/8" DR 5/16" |
| J49903/8 | Socket, Hex Bit 3/8" DR 3/8" |
| J2584 | Socket, Bar 6-1/4" |
| J2591 | Socket, Clip 3/8" DR |



- ▶ 1/8, 5/32, 3/16, 7/32, 1/4, 5/16, 3/8 Inch.
- ▶ Accessories: 6-1/4 Inch Socket Bar with 7 Socket Clips.
- ▶ Weight (lbs): 0.99

3/8" DRIVE 7 PIECE BALL STYLE EXTRA-LONG HEX BIT SET

Product #: J4900BD



| Contents | Description |
|----------|--|
| J4904BD | Socket, 3/8" DR 1/8" Ball Style Hex Bit |
| J4905BD | Socket, 3/8" DR 5/32" Ball Style Hex Bit |
| J4906BD | Socket, 3/8" DR 3/16" Ball Style Hex Bit |
| J4907BD | Socket, 3/8" DR 7/32" Ball Style Hex Bit |
| J4908BD | Socket, 3/8" DR 1/4" Ball Style Hex Bit |
| J4910BD | Socket, 3/8" DR 5/16" Ball Style Hex Bit |
| J4912BD | Socket, 3/8" DR 3/8" Ball Style Hex Bit |
| J2584 | Socket, Bar 6-1/4" |
| J2591 | Socket, Clip 3/8" DR |



- ▶ 1/8, 5/32, 3/16, 7/32, 1/4, 3/8 Inch.
- ▶ Accessories: 6-1/4 Inch Socket Bar and 7 Socket Clips.
- ▶ Weight (lbs): 1.46



3/8" DRIVE 7 PIECE EXTRA-LONG HEX BIT SET

Product #: J4990-7XL

| Contents | Description |
|-------------|--|
| J49901/8XL | Socket, 3/8" DR 1/8" Hex Bit Extra-Long |
| J49905/32XL | Socket, 3/8" DR 5/32" Hex Bit Extra-Long |
| J49903/16XL | Socket, 3/8" DR 3/16" Hex Bit Extra-Long |
| J49907/32XL | Socket, 3/8" DR 7/32" Hex Bit Extra-Long |
| J49901/4XL | Socket, 3/8" DR 1/4" Hex Bit Extra-Long |
| J49905/16XL | Socket, 3/8" DR 5/16" Hex Bit Extra-Long |
| J49903/8XL | Socket, 3/8" DR 3/8" Hex Bit Extra-Long |
| J2584 | Socket, Bar 6-1/4" |
| J2591 | Socket, Clip 3/8" DR |



- › 1/8, 5/32, 3/16, 7/32, 1/4, 5/16, 3/8 Inch.
- › Accessories: 6-1/4 Inch Socket Bar with 7 Socket Clips.
- › Weight (lbs): 1.21

3/8" DRIVE 7 PIECE SHORT HEX BIT SET

Product #: J4990-7ST

| Contents | Description |
|-------------|-------------------------------------|
| J49901/8ST | Socket, 3/8" DR 1/8" Hex Bit Short |
| J49905/32ST | Socket, 3/8" DR 5/32" Hex Bit Short |
| J49903/16ST | Socket, 3/8" DR 3/16" Hex Bit Short |
| J49907/32ST | Socket, 3/8" DR 7/32" Hex Bit Short |
| J49901/4ST | Socket, 3/8" DR 1/4" Hex Bit Short |
| J49905/16ST | Socket, 3/8" DR 5/16" Hex Bit Short |
| J49903/8ST | Socket, 3/8" DR 3/8" Hex Bit Short |
| J2584 | Socket, Bar 6-1/4" |
| J2591 | Socket, Clip 3/8" DR |



- › 1/4, 1/8, 3/16, 3/8, 5/16, 5/32, 7/32 Inch.
- › Accessories: 6-1/4 Inch Socket Bar, 7 Socket Clips.
- › Weight (lbs): 0.84

3/8" DRIVE 7 PIECE METRIC SHORT HEX BIT SET

Product #: J4990-MST

| Contents | Description |
|-------------|-------------------------------------|
| J4990-4MST | Socket, Hex Bit 3/8" DR 4 mm Short |
| J4990-5MST | Socket, Hex Bit 3/8" DR 5 mm Short |
| J4990-6MST | Socket, Hex Bit 3/8" DR 6 mm Short |
| J4990-7MST | Socket, Hex Bit 3/8" DR 7 mm Short |
| J4990-8MST | Socket, Hex Bit 3/8" DR 8 mm Short |
| J4990-9MST | Socket, Hex Bit 3/8" DR 9 mm Short |
| J4990-10MST | Socket, Hex Bit 3/8" DR 10 mm Short |
| J2584 | Socket, Bar 6-1/4" |
| J2591 | Socket, Clip 3/8" DR |



- › 4, 5, 6, 7, 8, 9, 10 mm.
- › Accessories: 6-1/4 Inch Socket Bar, 7 Socket Clips.
- › Weight (lbs): 0.83

3/8" DRIVE 7 PIECE METRIC HEX BIT SET

Product #: J4990-SMA

| Contents | Description |
|-----------|-------------------------------|
| J4990-4M | Socket, Hex Bit 3/8" DR 4 mm |
| J4990-5M | Socket, Hex Bit 3/8" DR 5 mm |
| J4990-6M | Socket, Hex Bit 3/8" DR 6 mm |
| J4990-7M | Socket, Hex Bit 3/8" DR 7 mm |
| J4990-8M | Socket, Hex Bit 3/8" DR 8 mm |
| J4990-9M | Socket, Hex Bit 3/8" DR 9 mm |
| J4990-10M | Socket, Hex Bit 3/8" DR 10 mm |
| J2584 | Socket, Bar 6-1/4" |
| J2591 | Socket, Clip 3/8" DR |



- › 4, 5, 6, 7, 8, 9, 10 mm.
- › Accessories: 6-1/4 Inch Socket Bar with 7 Socket Clips.
- › Weight (lbs): 1.04

3/8" DRIVE 6 PIECE METRIC EXTRA-LONG HEX BIT SET

Product #: J4990-SMXL

| Contents | Description |
|-------------|--------------------------------------|
| J4990-4MXL | Socket, Hex Bit 3/8" DR 4 mm X-Long |
| J4990-5MXL | Socket, Hex Bit 3/8" DR 5 mm X-Long |
| J4990-6MXL | Socket, Hex Bit 3/8" DR 6 mm X-Long |
| J4990-7MXL | Socket, Hex Bit 3/8" DR 7 mm X-Long |
| J4990-8MXL | Socket, Hex Bit 3/8" DR 8 mm X-Long |
| J4990-10MXL | Socket, Hex Bit 3/8" DR 10 mm X-Long |
| J2584 | Socket, Bar 6-1/4" |
| J2591 | Socket, Clip 3/8" DR |



- › 4, 5, 6, 7, 8, 10 mm
- › Accessories: 6-1/4 Inch Socket Bar with 6 Socket Clips.
- › Weight (lbs): 1.23



1/4" & 3/8" DRIVE 11 PIECE TORX® BIT SET

Product #: J5239P

| Contents | Description |
|----------|-------------------------------------|
| J60508 | Bit, Insert T10 Torx® 1/4" Hex |
| J60510 | Bit, Insert T15 Torx® 1/4" Hex |
| J60512 | Bit, Insert T20 Torx® 1/4" Hex |
| J60514 | Bit, Insert T25 Torx® 1/4" Hex |
| J60516 | Bit, Insert T27 Torx® 1/4" Hex |
| J60518 | Bit, Insert T30 Torx® 1/4" Hex |
| J60562 | Bit, Insert T40 Torx® 1/4" Hex |
| J60564 | Bit, Insert T45 Torx® 1/4" Hex |
| J60566 | Bit, Insert T50 Torx® 1/4" Hex |
| J6930 | Bit, Holder Power 3/8" DR 5/16" Hex |
| J6931 | Bit, Holder Power 3/8" DR 1/4" Hex |
| J25TR50C | Pouch |



- › T10 - T50, 2 Bit Holders, with Pouch.
- › Weight (lbs): 0.36



3/8" DRIVE 6 PIECE TORX® BIT SET

Product #: J5238C

| Contents | Description |
|-----------|-------------------------------|
| J5239-15W | Socket, Bit 3/8" DR T15 Torx® |
| J5239-20W | Socket, Bit 3/8" DR T20 Torx® |
| J5239-25W | Socket, Bit 3/8" DR T25 Torx® |
| J5239-27W | Socket, Bit 3/8" DR T27 Torx® |
| J5239-30W | Socket, Bit 3/8" DR T30 Torx® |
| J5239-40W | Socket, Bit 3/8" DR T40 Torx® |
| J2584 | Socket, Bar 6-1/4" |
| J2591 | Socket, Clip 3/8" DR |



- › T15, T20, T25, T27, T30, T40.
- › Accessories: 6-1/4 Inch Socket Bar with 6 Socket Clips.
- › Weight (lbs): 0.78



3/8" DRIVE 8 PIECE TORX® BIT SET

Product #: J5239C

| Contents | Description |
|-----------|-------------------------------|
| J5239-15W | Socket, Bit 3/8" DR T15 Torx® |
| J5239-20W | Socket, Bit 3/8" DR T20 Torx® |
| J5239-25W | Socket, Bit 3/8" DR T25 Torx® |
| J5239-27W | Socket, Bit 3/8" DR T27 Torx® |
| J5239-30W | Socket, Bit 3/8" DR T30 Torx® |
| J5239-40W | Socket, Bit 3/8" DR T40 Torx® |
| J5239-45W | Socket, Bit 3/8" DR T45 Torx® |
| J5239-50W | Socket, Bit 3/8" DR T50 Torx® |
| J2585 | Socket, Bar 9" |
| J2591 | Socket, Clip 3/8" DR |



- › T15, T20, T25, T27, T30, T40, T45, T50.
- › Accessories: 9 Inch Socket Bar with 8 Socket Clips.
- › Weight (lbs): 1.04



9 PIECE 3/8" DRIVE TORQUE ADAPTER SOCKET SET - 12 POINT

Product #: **J5100**



| Contents | Description | AS Spec. |
|----------|--------------------------------|---------------|
| J5112 | Torque Adapter, 3/8" DR 3/8" | AS954E S3.8.1 |
| J5114 | Torque Adapter, 3/8" DR 7/16" | AS954E S3.8.1 |
| J5116 | Torque Adapter, 3/8" DR 1/2" | AS954E S3.8.1 |
| J5118 | Torque Adapter, 3/8" DR 9/16" | AS954E S3.8.1 |
| J5120 | Torque Adapter, 3/8" DR 5/8" | AS954E S3.8.1 |
| J5122 | Torque Adapter, 3/8" DR 11/16" | AS954E S3.8.1 |
| J5124 | Torque Adapter, 3/8" DR 3/4" | AS954E S3.8.1 |
| J5126 | Torque Adapter, 3/8" DR 13/16" | AS954E S3.8.1 |
| J5128 | Torque Adapter, 3/8" DR 7/8" | AS954E S3.8.1 |
| J2599 | Socket Bar For Torque Adapters | |

- ▶ 12 Point Standard with Torque Adapter: 3/8, 7/16, 1/2, 9/16, 5/8, 11/16, 3/4, 13/16, 7/8 Inch.
- ▶ Accessories: Steel Holder.
- ▶ Weight (lbs): 1.32

3/8" DRIVE 6 PIECE ADAPTER SET

Product #: **J52006**



| Contents | Description | ASME Spec. |
|----------|--|---------------|
| J5255 | Adapter, 3/8" F x 1/4" M | ASME B107.500 |
| J5256 | Adapter, 1/4" F x 3/8" M | ASME B107.500 |
| J5253 | Adapter, 3/8" F x 1/2" M | ASME B107.500 |
| J7651 | Socket, Impact 1/2" DR Adapter 1/2" F x 3/8" M | ASME B107.2 |
| J7652 | Socket, Impact 1/2" DR Adapter 1/2" F x 3/4" M | ASME B107.2 |
| J7653 | Socket, Impact 1/2" DR Adapter 3/4" F x 1/2" M | ASME B107.2 |
| J2584 | Socket, Bar 6-1/4" | |
| J2590 | Socket, Clip 1/4" DR | |
| J2592 | Socket, Clip 1/2" DR | |

- ▶ Hand Impact: 3/8F x 1/4"M, 1/4F x 3/8"M, 3/8F x 1/2"M.
- ▶ Impact: 1/2F x 3/8"M, 1/2F x 3/4"M, 3/4F x 1/2"M.
- ▶ Accessories: 6-1/4" Socket Bar, 6 Socket Clips, Drive Size 1/4, 3/8, 1/2, and 3/4 Inch, Full Polish/Black Oxide Finish.
- ▶ Weight (lbs): 1.33

3/8" DRIVE 53 PIECE CROWFOOT WRENCH SET

Product #: **J49000CF**

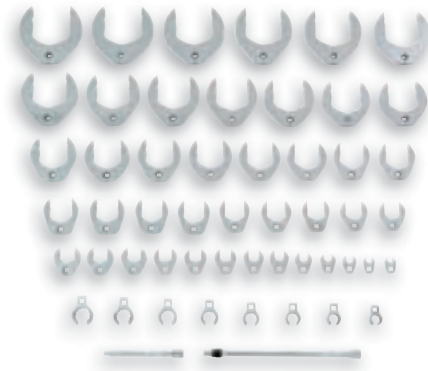

- ▶ Wrenches Included 3/8 Inch Drive: 3/8, 7/16, 1/2, 9/16, 5/8, 11/16, 3/4, 13/16, 7/8, 15/16, 1, 1-1/16, 1-1/8, 1-3/16, 1-1/4, 1-5/16, 1-3/8, 1-7/16, 1-1/2, 1-9/16, 1-5/8, 1-11/16, 1-3/4, 1-13/16, 1-7/8, 1-15/16, 2, 2-1/16, 2-1/8, 2-3/16, 2-1/4, 2-5/16, 2-3/8, 2-7/16, 2-1/2, 2-9/16, 2-5/8, 2-11/16, 2-3/4, 2-13/16, 2-7/8, 2-15/16, 3 Inch.
- ▶ Flare Nut: 5/8, 11/16, 3/4, 13/16, 7/8, 15/16, 1, 1-1/16, 3/8 Inch.
- ▶ Drive Locking Extensions: 3/8" Drive Locking Extensions: 6, 12" L.
- ▶ Full Polish Chrome Finish.
- ▶ Weight (lbs): 26.14

| Contents | Description | ASME Spec. |
|----------|--|--------------|
| J4912CF | Wrench, Crowfoot Open End 3/8" DR 3/8" | ASME B107.21 |
| J4914CF | Wrench, Crowfoot Open End 3/8" DR 7/16" | ASME B107.21 |
| J4916CF | Wrench, Crowfoot Open End 3/8" DR 1/2" | ASME B107.21 |
| J4918CF | Wrench, Crowfoot Open End 3/8" DR 9/16" | ASME B107.21 |
| J4920CF | Wrench, Crowfoot Open End 3/8" DR 5/8" | ASME B107.21 |
| J4922CF | Wrench, Crowfoot Open End 3/8" DR 11/16" | ASME B107.21 |
| J4924CF | Wrench, Crowfoot Open End 3/8" DR 3/4" | ASME B107.21 |
| J4926CF | Wrench, Crowfoot Open End 3/8" DR 13/16" | ASME B107.21 |
| J4928CF | Wrench, Crowfoot Open End 3/8" DR 7/8" | ASME B107.21 |
| J4930CF | Wrench, Crowfoot Open End 3/8" DR 15/16" | ASME B107.21 |
| J4932CF | Wrench, Crowfoot Open End 3/8" DR 1" | ASME B107.21 |



| Contents | Description | ASME Spec. |
|-----------------|--|-------------------|
| J4934CF | Wrench, Crowfoot Open End 3/8" DR 1-1/16" | ASME B107.21 |
| J4936CF | Wrench, Crowfoot Open End 3/8" DR 1-1/8" | ASME B107.21 |
| J4938CF | Wrench, Crowfoot Open End 3/8" DR 1-3/16" | ASME B107.21 |
| J4940CF | Wrench, Crowfoot Open End 3/8" DR 1-1/4" | ASME B107.21 |
| J4942CF | Wrench, Crowfoot Open End 3/8" DR 1-5/16" | ASME B107.21 |
| J4944CF | Wrench, Crowfoot Open End 3/8" DR 1-3/8" | ASME B107.21 |
| J4946CF | Wrench, Crowfoot Open End 3/8" DR 1-7/16" | ASME B107.21 |
| J4948CF | Wrench, Crowfoot Open End 3/8" DR 1-1/2" | ASME B107.21 |
| J4950CF | Wrench, Crowfoot Open End 3/8" DR 1-9/16" | ASME B107.21 |
| J4952CF | Wrench, Crowfoot Open End 3/8" DR 1-5/8" | ASME B107.21 |
| J4954CF | Wrench, Crowfoot Open End 3/8" DR 1-11/16" | ASME B107.21 |
| J4956CF | Wrench, Crowfoot Open End 3/8" DR 1-3/4" | ASME B107.21 |
| J4958CF | Wrench, Crowfoot Open End 3/8" DR 1-13/16" | ASME B107.21 |
| J4960CF | Wrench, Crowfoot Open End 3/8" DR 1-7/8" | ASME B107.21 |
| J4962CF | Wrench, Crowfoot Open End 3/8" DR 1-15/16" | ASME B107.21 |
| J4964CF | Wrench, Crowfoot Open End 3/8" DR 2" | ASME B107.21 |
| J4966CF | Wrench, Crowfoot Open End 3/8" DR 2-1/16" | ASME B107.21 |
| J4968CF | Wrench, Crowfoot Open End 3/8" DR 2-1/8" | ASME B107.21 |
| J4970CF | Wrench, Crowfoot Open End 3/8" DR 2-3/16" | ASME B107.21 |
| J4972CF | Wrench, Crowfoot Open End 3/8" DR 2-1/4" | ASME B107.21 |
| J4974CF | Wrench, Crowfoot Open End 3/8" DR 2-5/16" | ASME B107.21 |
| J4976CF | Wrench, Crowfoot Open End 3/8" DR 2-3/8" | ASME B107.21 |
| J4978CF | Wrench, Crowfoot Open End 3/8" DR 2-7/16" | ASME B107.21 |
| J4980CF | Wrench, Crowfoot Open End 3/8" DR 2-1/2" | ASME B107.21 |
| J4982CF | Wrench, Crowfoot Open End 3/8" DR 2-9/16" | ASME B107.21 |
| J4984CF | Wrench, Crowfoot Open End 3/8" DR 2-5/8" | ASME B107.21 |
| J4986CF | Wrench, Crowfoot Open End 3/8" DR 2-11/16" | ASME B107.21 |
| J4988CF | Wrench, Crowfoot Open End 3/8" DR 2-3/4" | ASME B107.21 |
| J4990CF | Wrench, Crowfoot Open End 3/8" DR 2-13/16" | ASME B107.21 |
| J4992CF | Wrench, Crowfoot Open End 3/8" DR 2-7/8" | ASME B107.21 |
| J4994CF | Wrench, Crowfoot Open End 3/8" DR 2-15/16" | ASME B107.21 |
| J4996CF | Wrench, Crowfoot Open End 3/8" DR 3" | ASME B107.21 |
| J4920FL | Wrench, Crowfoot Flare Nut 3/8" DR 5/8" | ASME B107.21 |
| J4922FL | Wrench, Crowfoot Flare Nut 3/8" DR 11/16" | ASME B107.21 |
| J4924FL | Wrench, Crowfoot Flare Nut 3/8" DR 3/4" | ASME B107.21 |
| J4926FL | Wrench, Crowfoot Flare Nut 3/8" DR 13/16" | ASME B107.21 |
| J4928FL | Wrench, Crowfoot Flare Nut 3/8" DR 7/8" | ASME B107.21 |
| J4930FL | Wrench, Crowfoot Flare Nut 3/8" DR 15/16" | ASME B107.21 |
| J4932FL | Wrench, Crowfoot Flare Nut 3/8" DR 1" | ASME B107.21 |
| J4934FL | Wrench, Crowfoot Flare Nut 3/8" DR 1-1/16" | ASME B107.21 |
| J5262L | Extension, 3/8" DR Locking 12" | ASME B107.500 |
| J5260-06L | Extension, 3/8" DR Locking 6" | ASME B107.500 |



3/8" DRIVE 43 PIECE CROWFOOT WRENCH SET

Product #: **J49001CF**

- ▶ Wrenches Included 3/8 Inch Drive: 3/8, 7/16, 1/2, 9/16, 5/8, 11/16, 3/4, 13/16, 7/8, 15/16, 1, 1-1/16, 1-1/8, 1-3/16, 1-1/4, 1-5/16.
- ▶ Full Polish Chrome Finish.
- ▶ Weight (lbs): 23.92



| Contents | Description | ASME Spec. |
|----------|--|--------------|
| J4912CF | Wrench, Crowfoot Open End 3/8" DR 3/8" | ASME B107.21 |
| J4914CF | Wrench, Crowfoot Open End 3/8" DR 7/16" | ASME B107.21 |
| J4916CF | Wrench, Crowfoot Open End 3/8" DR 1/2" | ASME B107.21 |
| J4918CF | Wrench, Crowfoot Open End 3/8" DR 9/16" | ASME B107.21 |
| J4920CF | Wrench, Crowfoot Open End 3/8" DR 5/8" | ASME B107.21 |
| J4922CF | Wrench, Crowfoot Open End 3/8" DR 11/16" | ASME B107.21 |
| J4924CF | Wrench, Crowfoot Open End 3/8" DR 3/4" | ASME B107.21 |
| J4926CF | Wrench, Crowfoot Open End 3/8" DR 13/16" | ASME B107.21 |
| J4928CF | Wrench, Crowfoot Open End 3/8" DR 7/8" | ASME B107.21 |
| J4930CF | Wrench, Crowfoot Open End 3/8" DR 15/16" | ASME B107.21 |
| J4932CF | Wrench, Crowfoot Open End 3/8" DR 1" | ASME B107.21 |
| J4934CF | Wrench, Crowfoot Open End 3/8" DR 1-1/16" | ASME B107.21 |
| J4936CF | Wrench, Crowfoot Open End 3/8" DR 1-1/8" | ASME B107.21 |
| J4938CF | Wrench, Crowfoot Open End 3/8" DR 1-3/16" | ASME B107.21 |
| J4940CF | Wrench, Crowfoot Open End 3/8" DR 1-1/4" | ASME B107.21 |
| J4942CF | Wrench, Crowfoot Open End 3/8" DR 1-5/16" | ASME B107.21 |
| J4944CF | Wrench, Crowfoot Open End 3/8" DR 1-3/8" | ASME B107.21 |
| J4946CF | Wrench, Crowfoot Open End 3/8" DR 1-7/16" | ASME B107.21 |
| J4948CF | Wrench, Crowfoot Open End 3/8" DR 1-1/2" | ASME B107.21 |
| J4950CF | Wrench, Crowfoot Open End 3/8" DR 1-9/16" | ASME B107.21 |
| J4952CF | Wrench, Crowfoot Open End 3/8" DR 1-5/8" | ASME B107.21 |
| J4954CF | Wrench, Crowfoot Open End 3/8" DR 1-11/16" | ASME B107.21 |
| J4956CF | Wrench, Crowfoot Open End 3/8" DR 1-3/4" | ASME B107.21 |
| J4958CF | Wrench, Crowfoot Open End 3/8" DR 1-13/16" | ASME B107.21 |
| J4960CF | Wrench, Crowfoot Open End 3/8" DR 1-7/8" | ASME B107.21 |
| J4962CF | Wrench, Crowfoot Open End 3/8" DR 1-15/16" | ASME B107.21 |
| J4964CF | Wrench, Crowfoot Open End 3/8" DR 2" | ASME B107.21 |
| J4966CF | Wrench, Crowfoot Open End 3/8" DR 2-1/16" | ASME B107.21 |
| J4968CF | Wrench, Crowfoot Open End 3/8" DR 2-1/8" | ASME B107.21 |
| J4970CF | Wrench, Crowfoot Open End 3/8" DR 2-3/16" | ASME B107.21 |
| J4972CF | Wrench, Crowfoot Open End 3/8" DR 2-1/4" | ASME B107.21 |
| J4974CF | Wrench, Crowfoot Open End 3/8" DR 2-5/16" | ASME B107.21 |
| J4976CF | Wrench, Crowfoot Open End 3/8" DR 2-3/8" | ASME B107.21 |
| J4978CF | Wrench, Crowfoot Open End 3/8" DR 2-7/16" | ASME B107.21 |
| J4980CF | Wrench, Crowfoot Open End 3/8" DR 2-1/2" | ASME B107.21 |
| J4982CF | Wrench, Crowfoot Open End 3/8" DR 2-9/16" | ASME B107.21 |
| J4984CF | Wrench, Crowfoot Open End 3/8" DR 2-5/8" | ASME B107.21 |
| J4986CF | Wrench, Crowfoot Open End 3/8" DR 2-11/16" | ASME B107.21 |
| J4988CF | Wrench, Crowfoot Open End 3/8" DR 2-3/4" | ASME B107.21 |
| J4990CF | Wrench, Crowfoot Open End 3/8" DR 2-13/16" | ASME B107.21 |
| J4992CF | Wrench, Crowfoot Open End 3/8" DR 2-7/8" | ASME B107.21 |
| J4994CF | Wrench, Crowfoot Open End 3/8" DR 2-15/16" | ASME B107.21 |
| J4996CF | Wrench, Crowfoot Open End 3/8" DR 3" | ASME B107.21 |





3/8" DRIVE 27 PIECE CROWFOOT WRENCH SET

Product #: **J49002CF**



- ▶ Wrenches Included 3/8 Inch Drive: 3/8, 7/16, 1/2, 9/16, 5/8, 11/16, 3/4, 13/16, 7/8, 15/16, 1, 1-1/16, 1-1/8, 1-3/16, 1-1/4, 1-5/16, 1-3/8, 1-7/16, 1-1/2, 1-9/16, 1-5/8, 1-11/16, 1-3/4, 1-13/16, 1-7/8, 1-15/16, 2 Inch.
- ▶ Full Polish Chrome Finish.
- ▶ Weight (lbs): 6.74



| Contents | Description | ASME Spec. |
|----------|--|--------------|
| J4912CF | Wrench, Crowfoot Open End 3/8" DR 3/8" | ASME B107.21 |
| J4914CF | Wrench, Crowfoot Open End 3/8" DR 7/16" | ASME B107.21 |
| J4916CF | Wrench, Crowfoot Open End 3/8" DR 1/2" | ASME B107.21 |
| J4918CF | Wrench, Crowfoot Open End 3/8" DR 9/16" | ASME B107.21 |
| J4920CF | Wrench, Crowfoot Open End 3/8" DR 5/8" | ASME B107.21 |
| J4922CF | Wrench, Crowfoot Open End 3/8" DR 11/16" | ASME B107.21 |
| J4924CF | Wrench, Crowfoot Open End 3/8" DR 3/4" | ASME B107.21 |
| J4926CF | Wrench, Crowfoot Open End 3/8" DR 13/16" | ASME B107.21 |
| J4928CF | Wrench, Crowfoot Open End 3/8" DR 7/8" | ASME B107.21 |
| J4930CF | Wrench, Crowfoot Open End 3/8" DR 15/16" | ASME B107.21 |
| J4932CF | Wrench, Crowfoot Open End 3/8" DR 1" | ASME B107.21 |
| J4934CF | Wrench, Crowfoot Open End 3/8" DR 1-1/16" | ASME B107.21 |
| J4936CF | Wrench, Crowfoot Open End 3/8" DR 1-1/8" | ASME B107.21 |
| J4938CF | Wrench, Crowfoot Open End 3/8" DR 1-3/16" | ASME B107.21 |
| J4940CF | Wrench, Crowfoot Open End 3/8" DR 1-1/4" | ASME B107.21 |
| J4942CF | Wrench, Crowfoot Open End 3/8" DR 1-5/16" | ASME B107.21 |
| J4944CF | Wrench, Crowfoot Open End 3/8" DR 1-3/8" | ASME B107.21 |
| J4946CF | Wrench, Crowfoot Open End 3/8" DR 1-7/16" | ASME B107.21 |
| J4948CF | Wrench, Crowfoot Open End 3/8" DR 1-1/2" | ASME B107.21 |
| J4950CF | Wrench, Crowfoot Open End 3/8" DR 1-9/16" | ASME B107.21 |
| J4952CF | Wrench, Crowfoot Open End 3/8" DR 1-5/8" | ASME B107.21 |
| J4954CF | Wrench, Crowfoot Open End 3/8" DR 1-11/16" | ASME B107.21 |
| J4956CF | Wrench, Crowfoot Open End 3/8" DR 1-3/4" | ASME B107.21 |
| J4958CF | Wrench, Crowfoot Open End 3/8" DR 1-13/16" | ASME B107.21 |
| J4960CF | Wrench, Crowfoot Open End 3/8" DR 1-7/8" | ASME B107.21 |
| J4962CF | Wrench, Crowfoot Open End 3/8" DR 1-15/16" | ASME B107.21 |
| J4964CF | Wrench, Crowfoot Open End 3/8" DR 2" | ASME B107.21 |



3/8" DRIVE 16 PIECE METRIC CROWFOOT WRENCH SET

METRIC

Product #: J4900MCF

- › Wrenches Included 3/8 Inch Drive: 9, 10, 11, 12, 13, 14, 15, 16, 17, 18, 19, 20, 21, 22, 23, 24 mm.
- › Full Polish Chrome Finish.
- › Weight (lbs): 2.59



| Contents | Description | ASME Spec. |
|----------|---|--------------|
| J4909MCF | Wrench, Crowfoot Open End 3/8" DR 9 mm | ASME B107.21 |
| J4910MCF | Wrench, Crowfoot Open End 3/8" DR 10 mm | ASME B107.21 |
| J4911MCF | Wrench, Crowfoot Open End 3/8" DR 11 mm | ASME B107.21 |
| J4912MCF | Wrench, Crowfoot Open End 3/8" DR 12 mm | ASME B107.21 |
| J4913MCF | Wrench, Crowfoot Open End 3/8" DR 13 mm | ASME B107.21 |
| J4914MCF | Wrench, Crowfoot Open End 3/8" DR 14 mm | ASME B107.21 |
| J4915MCF | Wrench, Crowfoot Open End 3/8" DR 15 mm | ASME B107.21 |
| J4916MCF | Wrench, Crowfoot Open End 3/8" DR 16 mm | ASME B107.21 |
| J4917MCF | Wrench, Crowfoot Open End 3/8" DR 17 mm | ASME B107.21 |
| J4918MCF | Wrench, Crowfoot Open End 3/8" DR 18 mm | ASME B107.21 |
| J4919MCF | Wrench, Crowfoot Open End 3/8" DR 19 mm | ASME B107.21 |
| J4920MCF | Wrench, Crowfoot Open End 3/8" DR 20 mm | ASME B107.21 |
| J4921MCF | Wrench, Crowfoot Open End 3/8" DR 21 mm | ASME B107.21 |
| J4922MCF | Wrench, Crowfoot Open End 3/8" DR 22 mm | ASME B107.21 |
| J4923MCF | Wrench, Crowfoot Open End 3/8" DR 23 mm | ASME B107.21 |
| J4924MCF | Wrench, Crowfoot Open End 3/8" DR 24 mm | ASME B107.21 |

3/8" DRIVE 15 PIECE CROWFOOT WRENCH SET

Product #: J49003CF

- › Wrenches Included 3/8 Inch Drive: 3/8, 7/16, 1/2, 9/16, 5/8, 11/16, 3/4, 13/16, 7/8, 15/16, 1, 1-1/16, 1-1/8, 1-3/16, 1-1/4 Inch.
- › Accessories: Socket Clips and Bar.
- › Full Polish Chrome Finish.
- › Weight (lbs): 2.07



| Contents | Description | ASME Spec. |
|----------|---|--------------|
| J4912CF | Wrench, Crowfoot Open End 3/8" DR 3/8" | ASME B107.21 |
| J4914CF | Wrench, Crowfoot Open End 3/8" DR 7/16" | ASME B107.21 |
| J4916CF | Wrench, Crowfoot Open End 3/8" DR 1/2" | ASME B107.21 |
| J4918CF | Wrench, Crowfoot Open End 3/8" DR 9/16" | ASME B107.21 |
| J4920CF | Wrench, Crowfoot Open End 3/8" DR 5/8" | ASME B107.21 |
| J4922CF | Wrench, Crowfoot Open End 3/8" DR 11/16" | ASME B107.21 |
| J4924CF | Wrench, Crowfoot Open End 3/8" DR 3/4" | ASME B107.21 |
| J4926CF | Wrench, Crowfoot Open End 3/8" DR 13/16" | ASME B107.21 |
| J4928CF | Wrench, Crowfoot Open End 3/8" DR 7/8" | ASME B107.21 |
| J4930CF | Wrench, Crowfoot Open End 3/8" DR 15/16" | ASME B107.21 |
| J4932CF | Wrench, Crowfoot Open End 3/8" DR 1" | ASME B107.21 |
| J4934CF | Wrench, Crowfoot Open End 3/8" DR 1-1/16" | ASME B107.21 |
| J4936CF | Wrench, Crowfoot Open End 3/8" DR 1-1/8" | ASME B107.21 |
| J4938CF | Wrench, Crowfoot Open End 3/8" DR 1-3/16" | ASME B107.21 |
| J4940CF | Wrench, Crowfoot Open End 3/8" DR 1-1/4" | ASME B107.21 |





3/8" DRIVE 9 PIECE CROWFOOT WRENCH SET

Product #: J49004CF

- › Wrenches Included 3/8 Inch Drive: 3/8, 7/16, 1/2, 9/16, 5/8, 11/16, 3/4, 13/16, 7/8 Inch.
- › Accessories: 13 Inch Socket Bar with 9 Socket Clips.
- › Full Polish Chrome Finish.
- › Weight (lbs): 0.83



| Contents | Description | ASME Spec. |
|----------|--|--------------|
| J4912CF | Wrench, Crowfoot Open End 3/8" DR 3/8" | ASME B107.21 |
| J4914CF | Wrench, Crowfoot Open End 3/8" DR 7/16" | ASME B107.21 |
| J4916CF | Wrench, Crowfoot Open End 3/8" DR 1/2" | ASME B107.21 |
| J4918CF | Wrench, Crowfoot Open End 3/8" DR 9/16" | ASME B107.21 |
| J4920CF | Wrench, Crowfoot Open End 3/8" DR 5/8" | ASME B107.21 |
| J4922CF | Wrench, Crowfoot Open End 3/8" DR 11/16" | ASME B107.21 |
| J4924CF | Wrench, Crowfoot Open End 3/8" DR 3/4" | ASME B107.21 |
| J4926CF | Wrench, Crowfoot Open End 3/8" DR 13/16" | ASME B107.21 |
| J4928CF | Wrench, Crowfoot Open End 3/8" DR 7/8" | ASME B107.21 |

3/8" DRIVE 8 PIECE CROWFOOT FLARE NUT WRENCH SET

Product #: J4900FL

- › Weight (lbs): 0.80

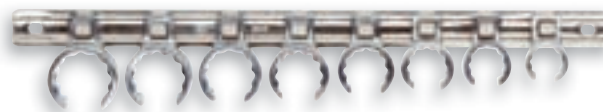

| Contents | Description | ASME Spec. |
|----------|--|--------------|
| J4920FL | Wrench, Crowfoot 3/8" DR 5/8" Flare Nut | ASME B107.21 |
| J4922FL | Wrench, Crowfoot 3/8" DR 11/16" Flare Nut | ASME B107.21 |
| J4924FL | Wrench, Crowfoot 3/8" DR 3/4" Flare Nut | ASME B107.21 |
| J4926FL | Wrench, Crowfoot 3/8" DR 13/16" Flare Nut | ASME B107.21 |
| J4928FL | Wrench, Crowfoot 3/8" DR 7/8" Flare Nut | ASME B107.21 |
| J4930FL | Wrench, Crowfoot 3/8" DR 15/16" Flare Nut | ASME B107.21 |
| J4932FL | Wrench, Crowfoot 3/8" DR 1" Flare Nut | ASME B107.21 |
| J4934FL | Wrench, Crowfoot 3/8" DR 1-1/16" Flare Nut | ASME B107.21 |
| J2586 | Socket, Bar 13" | |
| J2591 | Socket, Clip 3/8" DR | |

3/8" DRIVE 8 PIECE CROWFOOT FLARE NUT WRENCH SET

Product #: J49000CFN

- › Wrenches Included Flare Nut 3/8 Inch Drive: 5/8, 11/16, 3/4, 13/16, 7/8, 15/16, 1, 1-1/16 Inch.
- › Full Polish Chrome Finish.
- › Weight (lbs): 1.15



| Contents | Description | ASME Spec. |
|----------|--|--------------|
| J4920FL | Wrench, Crowfoot Flare Nut 3/8" DR 5/8" | ASME B107.21 |
| J4922FL | Wrench, Crowfoot Flare Nut 3/8" DR 11/16" | ASME B107.21 |
| J4924FL | Wrench, Crowfoot Flare Nut 3/8" DR 3/4" | ASME B107.21 |
| J4926FL | Wrench, Crowfoot Flare Nut 3/8" DR 13/16" | ASME B107.21 |
| J4928FL | Wrench, Crowfoot Flare Nut 3/8" DR 7/8" | ASME B107.21 |
| J4930FL | Wrench, Crowfoot Flare Nut 3/8" DR 15/16" | ASME B107.21 |
| J4932FL | Wrench, Crowfoot Flare Nut 3/8" DR 1" | ASME B107.21 |
| J4934FL | Wrench, Crowfoot Flare Nut 3/8" DR 1-1/16" | ASME B107.21 |





3/8" DRIVE STANDARD LENGTH PREMIUM PEAR HEAD RATCHETS

- › Small pear head design for access in tight, hard to reach work areas.
- › 45-tooth gear provides balance between 8° articulation angle and high torque carrying capacity.
- › Sealed design helps prevent debris from entering the ratchet mechanism reducing wear. Also, helps to keep lubrication contained within the components. Patent pending design.
- › Low profile reversing lever design for quick, one-hand operation.
- › Contoured, ergonomically-designed handle for comfort. Knurled bands allow for increased grip and slip resistance.
- › Double nickel chrome plated for enhanced corrosion protection or Black oxide finish.
- › Field repairable.



| Product # | Drive Size (in) | Finish | Overall Length (in) | Weight (lbs) | Repair Kit |
|-----------|-----------------|-------------|---------------------|--------------|------------|
| J5249XL | 3/8 | Full Polish | 8-1/2 | 0.86 | J5249XLRK |
| J5249XLBL | 3/8 | Black Oxide | 8-1/2 | 0.87 | J5249XLRK |

ASME B107.500

3/8" DRIVE QUICK RELEASE PREMIUM PEAR HEAD RATCHET

- › Small, pear head design for access in tight, hard to reach work areas.
- › 45-tooth gear, 8° swing articulation.
- › Low profile quick release button for access in restricted areas.
- › Low profile reversing lever design for quick, one-hand operation.
- › Patented sealed head design helps prevent debris from entering the ratchet mechanism reducing wear. Also, helps to keep lubrication contained within the components.
- › Contoured, ergonomically-designed handle for comfort. Knurled bands allow for increased grip and slip resistance.
- › Full polished handle, easy to clean.
- › Double nickel chrome plated for enhanced corrosion protection meeting aerospace requirements.
- › Field repairable.



| Product # | Drive Size (in) | Finish | Overall Length (in) | Weight (lbs) | Repair Kit |
|-------------|-----------------|-------------|---------------------|--------------|-------------|
| J5249XLQR | 3/8 | Full Polish | 8-1/2 | 0.86 | J5249XLQRRK |
| J5249XLQRBL | 3/8 | Black Oxide | 8-1/2 | 0.86 | J5249XLQRRK |

ASME B107.10

3/8" DRIVE LONG HANDLE PREMIUM PEAR HEAD RATCHETS

- › Small pear head design for access in tight, hard to reach work areas.
- › 45-tooth gear provides balance between 8° articulation angle and high torque carrying capacity.
- › Sealed design helps prevent debris from entering the ratchet mechanism reducing wear. Also, helps to keep lubrication contained within the components. Patent pending design.
- › Low profile reversing lever design for quick, one-hand operation.
- › Contoured, ergonomically-designed handle for comfort. Knurled bands allow for increased grip and slip resistance.
- › Double nickel chrome plated for enhanced corrosion protection or Black oxide finish.
- › Field repairable.



| Product # | Drive Size (in) | Finish | Overall Length (in) | Weight (lbs) | Repair Kit |
|-----------|-----------------|-------------|---------------------|--------------|------------|
| J5250XL | 3/8 | Full Polish | 11 | 1.03 | J5249XLRK |
| J5250XLBL | 3/8 | Black Oxide | 11 | 0.98 | J5249XLRK |

ASME B107.500

3/8" DRIVE AEROSPACE PREMIUM PEAR HEAD RATCHET



- › Vertical hole drilled in drive plug, designed for installation of frangible collars on threaded pins.
- › Unique 45-tooth gear pawl design provides 8° ratcheting angle while maximizing ultimate torque.
- › Thin head design for access into tight work areas.
- › Reversing lever designed for quick, one-hand operation.
- › Full polish nickel chrome plated.



| Product # | Drive Size (in) | Finish | Overall Length (in) | Weight (lbs) | Repair Kit |
|------------------|-----------------|-------------|---------------------|--------------|-------------|
| J5249XLHS | 3/8 | Full Polish | 8-1/2 | 0.86 | J5249XLHSRK |

ASME B107.500

3/8" DRIVE STUBBY CLASSIC PEAR HEAD RATCHET

- › Robust 24-tooth design with 15° arc swing.
- › Alloy steel drive gear for strength and durability.
- › Low profile head for access in constricted areas.
- › Reversing lever design for quick, one-hand operation.
- › Knurled slip-resistant grip.



| Product # | Drive Size (in) | Finish | Overall Length (in) | Weight (lbs) | Repair Kit |
|---------------|-----------------|-------------|---------------------|--------------|------------|
| J5248S | 3/8 | Full Polish | 5 | 0.28 | J5249RK |

ASME B107.500

3/8" DRIVE STANDARD LENGTH CLASSIC PEAR HEAD RATCHETS

- › Tough, replaceable, molded plastic head.
- › Robust 24-tooth design with 15° arc swing.
- › Alloy steel drive gear for strength and durability.
- › Low profile head for access in constricted areas.
- › Reversing lever design for quick, one-hand operation.
- › Knurled slip-resistant grip.



| Product # | Drive Size (in) | Finish | Overall Length (in) | Weight (lbs) | Repair Kit |
|----------------|-----------------|-------------|---------------------|--------------|------------|
| J5249 | 3/8 | Full Polish | 7 | 0.61 | J5249RK |
| J5249BL | 3/8 | Black Oxide | 7 | 0.62 | J5249RK |

ASME B107.500

3/8" DRIVE LONG HANDLE CLASSIC PEAR HEAD RATCHETS

- › Robust 24-tooth design with 15° arc swing.
- › Alloy steel drive gear for strength and durability.
- › Low profile head for access in constricted areas.
- › Reversing lever design for quick, one-hand operation.
- › Knurled slip-resistant grip.



| Product # | Drive Size (in) | Finish | Overall Length (in) | Weight (lbs) | Repair Kit |
|----------------|-----------------|-------------|---------------------|--------------|------------|
| J5250 | 3/8 | Full Polish | 11 | 0.89 | J5249RK |
| J5250BL | 3/8 | Black Oxide | 11 | 0.81 | J5249RK |

ASME B107.500





3/8" DRIVE AEROSPACE CLASSIC PEAR HEAD RATCHET

- › Vertical hole drilled in drive plug, designed for installation of frangible collars on threaded pins.
- › Metal spring clip on drive plug for positive socket retention.
- › Unique 24-tooth gear pawl design provides 15° ratcheting angle while maximizing ultimate torque.
- › Thin head design for access into tight work areas.
- › Reversing lever designed for quick, one-hand operation.



| Product # | Drive Size (in) | Finish | Overall Length (in) | Weight (lbs) | Repair Kit |
|----------------|-----------------|-------------|---------------------|--------------|------------|
| J5249HS | 3/8 | Full Polish | 7 | 0.62 | J5249HSRK |

 ASME B107.500

3/8" DRIVE STANDARD LENGTH ROUND HEAD RATCHET

- › Small head design and tight swing arc allows fastener to access tight areas.
- › Full polished shaft with knurled grip for slip-resistant and strong grip.
- › 5° ratcheting angle.



| Product # | Drive Size (in) | Finish | Overall Length (in) | Weight (lbs) | Repair Kit |
|---------------|-----------------|-------------|---------------------|--------------|------------|
| J5252F | 3/8 | Full Polish | 7-3/8 | 0.57 | J5252FRK |

ASME B107.500

3/8" DRIVE FLEX-HEAD RATCHET

- › 180° flex.
- › 72-tooth gear.
- › 5° ratcheting angle.
- › Small head design and tight swing to allow access to fastener in a tight area.
- › Full polish shaft with knurled grip allows for a strong slip-resistant grip.



| Product # | Drive Size (in) | Finish | Overall Length (in) | Weight (lbs) | Repair Kit |
|---------------|-----------------|-------------|---------------------|--------------|------------|
| J5257F | 3/8 | Full Polish | 8-1/2 | 0.86 | J5252FRK |

ASME B107.500

3/8" DRIVE FEMALE DRIVE RATCHET

- › Robust 24-tooth design with 15° arc swing.
- › Alloy steel drive gear for strength and durability.
- › Low profile head for access in constricted areas.
- › Reversing lever design for quick, one-hand operation.
- › Knurled slip-resistant grip.
- › Made of heat-treated alloy steel.



| Product # | Drive Size (in) | Finish | Overall Length (in) | Weight (lbs) | Repair Kit |
|----------------|-----------------|-------------|---------------------|--------------|------------|
| J5249FW | 3/8 | Full Polish | 7 | 0.56 | J5249FWRK |

 ASME B107.500

3/8" DRIVE SPINNER RATCHET

- › Made from alloy steel.
- › Heat-treated for strength and durability.
- › Fits on the drive end of the ratchet for quickly running down the fastener before final tightening with the ratchet.



| Product # | Drive Size (in) | Finish | Overall Length (in) | Weight (lbs) |
|--------------|-----------------|-------------|---------------------|--------------|
| J5251 | 3/8 | Full Polish | 1-1/2 | 0.56 |

 ASME B107.500



3/8" DRIVE FLEXIBLE DRIVER

- › Made of heat-treated alloy steel.

| Product # | Drive Size (in) | Overall Length (in) | Weight (lbs) |
|---|-----------------|---------------------|---------------|
| J5267 | 3/8 | 9 | 0.35 |
|  | | | ASME B107.500 |



3/8" DRIVE RATCHET ADAPTERS

- › Converts standard handles to ratcheting handles.

| Product # | Drive Size (in) | Finish | Overall Length (in) | Weight (lbs) |
|---|-----------------|-------------|---------------------|--------------|
| J5247 | 3/8 | Full Polish | 2-1/16 | 0.34 |
|  | | | ASME B107.500 | |



3/8" DRIVE HINGE HANDLES

- › Made of heat-treated alloy steel
- › Head flexes 90° from horizontal.

| Product # | Drive Size (in) | Finish | Overall Length (in) | Weight (lbs) |
|---|-----------------|-------------|---------------------|--------------|
| J5265 | 3/8 | Full Polish | 8-1/2 | 0.58 |
| J5265BL | 3/8 | Black Oxide | 8-1/2 | 0.58 |
| J5266 | 3/8 | Full Polish | 12 | 0.80 |
|  | | | ASME B107.500 | |



3/8" DRIVE SPEED HANDLE

- › Made from alloy steel.
- › Heat-treated for strength and durability.

| Product # | Drive Size (in) | Finish | Overall Length (in) | Weight (lbs) |
|---|-----------------|-------------|---------------------|--------------|
| J5280G | 3/8 | Full Polish | 17-1/2 | 0.86 |
|  | | | ASME B107.500 | |



3/8" DRIVE SLIDING T-HANDLE

- › Made from alloy steel.
- › Heat-treated for strength and durability.

| Product # | Drive Size (in) | Finish | Overall Length (in) | Weight (lbs) |
|---|-----------------|-------------|---------------------|--------------|
| J5285 | 3/8 | Full Polish | 8 | 0.41 |
|  | | | ASME B107.500 | |





3/8" DRIVE STANDARD EXTENSIONS

- › Made from alloy steel.
- › Heat-treated for strength and durability.

| Product # | Drive Size (in) | Finish | Overall Length (in) | Weight (lbs) |
|------------------|-----------------|-------------|---------------------|--------------|
| J5259 | 3/8 | Full Polish | 1-3/4 | 0.11 |
| J5259B | 3/8 | Black Oxide | 1-3/4 | 0.11 |
| J5260 | 3/8 | Full Polish | 3 | 0.16 |
| J5260B | 3/8 | Black Oxide | 3 | 0.16 |
| J5260-06 | 3/8 | Full Polish | 6 | 0.31 |
| J5260-06B | 3/8 | Black Oxide | 6 | 0.30 |
| J5261 | 3/8 | Full Polish | 8 | 0.40 |
| J5261B | 3/8 | Black Oxide | 8 | 0.46 |
| J5262 | 3/8 | Full Polish | 12 | 0.61 |
| J5262B | 3/8 | Black Oxide | 12 | 0.62 |
| J5263 | 3/8 | Full Polish | 17-3/16 | 0.94 |

 ASME B107.500



3/8" DRIVE LOCKING EXTENSIONS

- › One-piece extension design.
- › Provides positive socket retention.
- › Use where accidental socket disengagement may be a concern or safety hazard.

| Product # | Drive Size (in) | Finish | Overall Length (in) | Weight (lbs) |
|------------------|-----------------|-------------|---------------------|--------------|
| J5260-03L | 3/8 | Full Polish | 3 | 0.21 |
| J5260-06L | 3/8 | Full Polish | 6 | 0.37 |
| J5261L | 3/8 | Full Polish | 8 | 0.49 |
| J5262L | 3/8 | Full Polish | 12 | 0.71 |

 ASME B107.500



3/8" DRIVE WOBBLE EXTENSIONS

- › Provides up to a 17° angle of operation.
- › Made from alloy steel.
- › Heat-treated for strength and durability.
- › Rigid wobble extension.

| Product # | Drive Size (in) | Finish | Overall Length (in) | Weight (lbs) |
|------------------|-----------------|-------------|---------------------|--------------|
| J5259W | 3/8 | Full Polish | 1-3/4 | 0.11 |
| J5260W | 3/8 | Full Polish | 3 | 0.17 |
| J5260-06W | 3/8 | Full Polish | 6 | 0.29 |
| J5261W | 3/8 | Full Polish | 8 | 0.42 |
| J5262W | 3/8 | Full Polish | 12 | 0.65 |
| J5263W | 3/8 | Full Polish | 17-3/16 | 0.92 |

 ASME B107.500



3/8" DRIVE FLEXIBLE EXTENSIONS

- › Made of heat-treated alloy steel.

| Product # | Drive Size (in) | Finish | Overall Length (in) | Weight (lbs) |
|--------------|-----------------|-------------|---------------------|--------------|
| J5268 | 3/8 | Black Oxide | 8 | 0.25 |

 ASME B107.500



3/8" DRIVE DRIVE ADAPTERS

| Product # | Size (in) | Finish | Overall Length (in) | Weight (lbs) |
|-----------|-----------------|-------------|---------------------|--------------|
| J5256 | 1/4" F x 3/8" M | Full Polish | 1 | 0.04 |
| J5253 | 3/8" F x 1/2" M | Full Polish | 1-7/16 | 0.11 |
| J5255 | 3/8" F x 1/4" M | Full Polish | 1 | 0.05 |
| J5254 | 1/2" F x 3/8" M | Full Polish | 1-3/8 | 0.13 |

ASME B107.500



3/8" DRIVE LOCKING ADAPTER

- › Includes hex key for easy locking into drive tool.
- › Knurl locking ring.

| Product # | Finish | Overall Length (in) | Weight (lbs) |
|-------------|-------------|---------------------|--------------|
| J5260-02BLS | Black Oxide | 2-1/8 | 0.12 |

ASME



3/8" DRIVE UNIVERSAL JOINTS

| Product # | Drive Size (in) | Finish | Overall Length (in) | Weight (lbs) |
|-----------|-----------------|-------------|---------------------|--------------|
| J5270A | 3/8 | Full Polish | 1-7/8 | 0.13 |

ASME B107.500



3/8" DRIVE SOCKETS - 6 POINT

- › Proto® 6 Point Sockets are ideal for use on stubborn or damaged fasteners, and also on fasteners made from soft materials.
- › TorquePlus™ features apply.



| Product # | Size (in) (A) | Nut End Outside Dia. (in) (B) | Drive End Outside Dia. (in) (C) | Nut Depth (in) (D) | Bolt Clearance Depth (in) (E) | Overall Length (in) (L) | Weight (lbs) |
|-----------|---------------|-------------------------------|---------------------------------|--------------------|-------------------------------|-------------------------|--------------|
| J5206H | 3/16 | 5/16 | 43/64 | 23/64 | 21/32 | 1-3/32 | 0.07 |
| J5208H | 1/4 | 13/32 | 43/64 | 23/64 | 21/32 | 1-3/32 | 0.05 |
| J5209H | 9/32 | 27/64 | 43/64 | 23/64 | 21/32 | 1-3/32 | 0.05 |
| J5210H | 5/16 | 15/32 | 43/64 | 23/64 | 21/32 | 1-3/32 | 0.06 |
| J5211H | 11/32 | 1/2 | 43/64 | 23/64 | 21/32 | 1-3/32 | 0.06 |
| J5212H | 3/8 | 9/16 | 43/64 | 23/64 | 21/32 | 1-3/32 | 0.07 |
| J5214H | 7/16 | 41/64 | 43/64 | 23/64 | 21/32 | 1-3/32 | 0.06 |
| J5216H | 1/2 | 47/64 | 47/64 | 23/64 | 11/16 | 1-1/8 | 0.08 |
| J5218H | 9/16 | 13/16 | 13/16 | 1/2 | 11/16 | 1-1/8 | 0.09 |
| J5220H | 5/8 | 7/8 | 7/8 | 33/64 | 11/16 | 1-1/8 | 0.11 |
| J5222H | 11/16 | 61/64 | 61/64 | 17/32 | 11/16 | 1-1/8 | 0.13 |
| J5224H | 3/4 | 1-1/64 | 1-1/64 | 39/64 | 3/4 | 1-3/16 | 0.15 |
| J5226H | 13/16 | 1-3/32 | 1-3/32 | 39/64 | 3/4 | 1-3/16 | 0.18 |
| J5228H | 7/8 | 1-3/16 | 1-3/16 | 43/64 | 7/8 | 1-5/16 | 0.24 |
| J5230H | 15/16 | 1-1/4 | 1-1/4 | 49/64 | 7/8 | 1-5/16 | 0.26 |
| J5232H | 1 | 1-5/16 | 1-5/16 | 13/16 | 15/16 | 1-3/8 | 0.30 |

ASME

B107.1



3/8" DRIVE METRIC SOCKETS - 6 POINT

METRIC

- › Proto® 6 Point Sockets are ideal for use on stubborn or damaged fasteners, and also on fasteners made from soft materials.
- › TorquePlus™ features apply.



| Product # | Size (mm) (A) | Nut End Outside Dia. (in) (B) | Drive End Outside Dia. (in) (C) | Nut Depth (in) (D) | Bolt Clearance Depth (in) (E) | Overall Length (in) (L) | Weight (lbs) |
|-----------|---------------|-------------------------------|---------------------------------|--------------------|-------------------------------|-------------------------|--------------|
| J52055MH | 5.5 | 23/64 | 43/64 | 1/4 | 21/32 | 1-3/32 | 0.04 |
| J5206MH | 6 | 25/64 | 43/64 | 1/4 | 39/64 | 1-3/32 | 0.04 |
| J5207MH | 7 | 27/64 | 43/64 | 1/4 | 39/64 | 1-3/32 | 0.05 |
| J5208MH | 8 | 15/32 | 43/64 | 1/4 | 39/64 | 1-3/32 | 0.04 |
| J5209MH | 9 | 33/64 | 43/64 | 9/32 | 39/64 | 1-3/32 | 0.04 |
| J5210MH | 10 | 19/32 | 43/64 | 9/32 | 1-3/32 | 1-3/32 | 0.04 |
| J5211MH | 11 | 41/64 | 43/64 | 9/32 | 39/64 | 1-3/32 | 0.04 |
| J5212MH | 12 | 45/64 | 45/64 | 9/32 | 11/16 | 1-1/8 | 0.05 |
| J5213MH | 13 | 47/64 | 47/64 | 9/32 | 11/16 | 1-1/8 | 0.08 |
| J5214MH | 14 | 25/32 | 25/32 | 15/32 | 11/16 | 1-1/8 | 0.08 |
| J5215MH | 15 | 27/32 | 27/32 | 17/32 | 11/16 | 1-1/8 | 0.09 |
| J5216MH | 16 | 55/64 | 55/64 | 17/32 | 11/16 | 1-1/8 | 0.09 |
| J5217MH | 17 | 15/16 | 15/16 | 17/32 | 11/16 | 1-1/8 | 0.13 |
| J5218MH | 18 | 61/64 | 61/64 | 17/32 | 3/4 | 1-3/16 | 0.13 |
| J5219MH | 19 | 1 | 1 | 17/32 | 3/4 | 1-3/16 | 0.14 |
| J5220MH | 20 | 1-3/32 | 1-3/32 | 5/8 | 3/4 | 1-3/16 | 0.16 |
| J5221MH | 21 | 1-3/32 | 1-3/32 | 5/8 | 51/64 | 1-15/64 | 0.18 |
| J5222MH | 22 | 1-11/64 | 1-11/64 | 43/64 | 57/64 | 1-5/16 | 0.24 |
| J5223MH | 23 | 1-3/16 | 1-3/16 | 57/64 | 57/64 | 1-5/16 | 0.23 |
| J5224MH | 24 | 1-1/4 | 1-1/4 | 49/64 | 57/64 | 1-5/16 | 0.26 |
| J5225MH | 25 | 9/64 | 1-21/64 | 49/64 | 15/16 | 1-3/8 | 0.32 |
| J5226MH | 26 | 1-21/64 | 1-21/64 | 49/64 | 15/16 | 1-3/8 | 0.30 |



ASME B107.5M



THE STORY BEHIND



TorquePlus™ is a fresh look at an old problem in sockets: worn, stripped and stubborn fasteners.

Conventional sockets contact the fasteners near the points of both the fastener and the socket, where they are the weakest.

Excessive force on this combination of fastener and socket can cause fastener rounding, or cut through the socket wall.

The TorquePlus™ design enables sockets to grip the fastener flats, away from the points.

- › Allows up to 15% more torque to be applied safely to the fastener.
- › Reduces the risk of fastener rounding.
- › Improves the ability to turn worn or rounded fasteners.

The TorquePlus™ design also meets aerospace specifications.

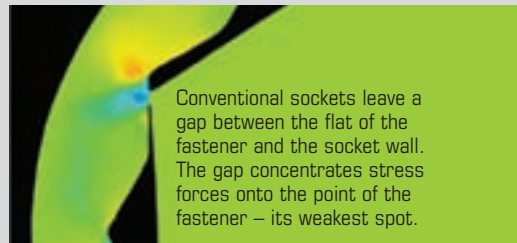

STRESS MAP of a conventional socket.

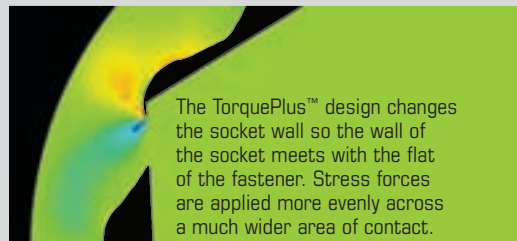

STRESS MAP of a TorquePlus™ socket.

3/8" DRIVE DEEP SOCKETS - 6 POINT

- ▶ Proto® 6 Point Sockets are ideal for use on stubborn or damaged fasteners, and also on fasteners made from soft materials.
- ▶ TorquePlus™ features apply.



| Product # | Size (in) (A) | Nut End Outside Dia. (in) (B) | Drive End Outside Dia. (in) (C) | Nut Depth (in) (D) | Bolt Clearance Depth (in) (E) | Overall Length (in) (L) | Weight (lbs) |
|-----------|---------------|-------------------------------|---------------------------------|--------------------|-------------------------------|-------------------------|--------------|
| J5008H | 1/4 | 25/64 | 41/64 | 21/64 | 1-11/16 | 2-1/8 | 0.12 |
| J5010H | 5/16 | 11/32 | 41/64 | 11/32 | 1-11/16 | 2-1/8 | 0.10 |
| J5011H | 11/32 | 1/2 | 41/64 | 21/32 | 1-11/16 | 2-1/8 | 0.10 |
| J5012H | 3/8 | 9/16 | 41/64 | 11/32 | 1-11/16 | 2-1/8 | 0.11 |
| J5014H | 7/16 | 41/64 | 41/64 | 7/16 | 1-11/16 | 2-1/8 | 0.12 |
| J5016H | 1/2 | 23/32 | 23/32 | 33/64 | 1-11/16 | 2-1/8 | 0.14 |
| J5018H | 9/16 | 51/64 | 51/64 | 19/32 | 1-11/16 | 2-1/8 | 0.17 |
| J5020H | 5/8 | 7/8 | 7/8 | 21/32 | 1-11/16 | 2-3/4 | 0.25 |
| J5022H | 11/16 | 61/64 | 61/64 | 21/32 | 1-23/32 | 2-3/4 | 0.29 |
| J5024H | 3/4 | 1-1/64 | 1-1/64 | 11/16 | 1-23/32 | 2-3/4 | 0.32 |
| J5026H | 13/16 | 1-5/64 | 1-5/64 | 11/16 | 2-5/64 | 2-3/4 | 0.35 |
| J5028H | 7/8 | 1-11/64 | 1-11/64 | 11/16 | 2-5/64 | 2-3/4 | 0.40 |
| J5030H | 15/16 | 1-15/64 | 1-15/64 | 1-3/16 | 2-5/64 | 2-3/4 | 0.52 |
| J5032H | 1 | 1-21/64 | 1-21/64 | 1-3/16 | 2-5/64 | 2-3/4 | 0.58 |



ASME B107.1

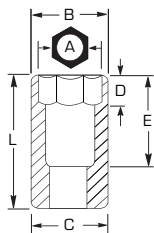

3/8" DRIVE METRIC DEEP SOCKETS - 6 POINT

- ▶ Proto® 6 Point Sockets are ideal for use on stubborn or damaged fasteners, and also on fasteners made from soft materials.
- ▶ TorquePlus™ features apply.



| Product # | Size (mm) (A) | Nut End Outside Dia. (in) (B) | Drive End Outside Dia. (in) (C) | Nut Depth (in) (D) | Bolt Clearance Depth (in) (E) | Overall Length (in) (L) | Weight (lbs) |
|-----------|---------------|-------------------------------|---------------------------------|--------------------|-------------------------------|-------------------------|--------------|
| J5006MH | 6 | 25/64 | 21/32 | 5/16 | 1-11/16 | 2-1/8 | 0.10 |
| J5007MH | 7 | 27/64 | 21/32 | 5/16 | 1-11/16 | 2-1/8 | 0.09 |
| J5008MH | 8 | 15/32 | 21/32 | 5/16 | 1-15/16 | 2-1/8 | 0.10 |
| J5009MH | 9 | 33/64 | 21/32 | 25/64 | 1-11/16 | 2-1/8 | 0.10 |
| J5010MH | 10 | 37/64 | 21/32 | 25/64 | 1-11/16 | 2-1/8 | 0.11 |
| J5011MH | 11 | 21/32 | 21/32 | 7/16 | 1-11/16 | 2-1/8 | 0.12 |
| J5012MH | 12 | 45/64 | 45/64 | 33/64 | 1-1/2 | 2-1/8 | 0.14 |
| J5013MH | 13 | 23/32 | 23/32 | 33/64 | 1-1/2 | 2-1/8 | 0.15 |
| J5014MH | 14 | 25/32 | 25/32 | 19/32 | 1-1/2 | 2-1/8 | 0.16 |
| J5015MH | 15 | 55/64 | 55/64 | 21/32 | 2-5/16 | 2-3/4 | 0.24 |
| J5016MH | 16 | 55/64 | 55/64 | 21/32 | 2-5/16 | 2-3/4 | 0.24 |
| J5017MH | 17 | 15/16 | 15/16 | 21/32 | 2-5/16 | 2-3/4 | 0.28 |
| J5018MH | 18 | 15/16 | 15/16 | 21/32 | 2-5/16 | 2-3/4 | 0.28 |
| J5019MH | 19 | 1-1/64 | 1-1/64 | 11/16 | 2-5/16 | 2-3/4 | 0.33 |
| J5020MH | 20 | 1-5/64 | 1-5/64 | 11/16 | 2-5/16 | 2-3/4 | 0.35 |
| J5021MH | 21 | 1-5/64 | 1-5/64 | 11/16 | 2-5/16 | 2-3/4 | 0.35 |
| J5022MH | 22 | 1-11/64 | 1-11/64 | 11/16 | 2-5/16 | 2-3/4 | 0.46 |
| J5023MH | 23 | 1-15/64 | 1-15/64 | 1-3/16 | 2-5/16 | 2-3/4 | 0.55 |
| J5024MH | 24 | 1-9/32 | 1-9/32 | 1-3/16 | 2-5/16 | 2-3/4 | 0.56 |
| J5025MH | 25 | 1-9/32 | 1-9/32 | 1-3/16 | 2-5/16 | 2-3/4 | 0.56 |
| J5026MH | 26 | 1-9/32 | 1-9/32 | 1-3/16 | 2-5/16 | 2-3/4 | 0.65 |



ASME B107.5M



3/8" DRIVE SUPER SHORT SOCKETS - 6 POINT

- › Proto® 6 Point Sockets can be used on stubborn hex bolts or bolts made from softer materials.
- › TorquePlus™ features apply.
- › Contact stresses are dispersed over a larger area.
- › Risk of rounding the fastener is reduced.
- › Enables users to turn worn, rounded fasteners.



| Product # | Size (in) (A) | Nut End Outside Dia. (in) (B) | Overall Length (in) (L) | Weight (lbs) |
|-----------|---------------|-------------------------------|-------------------------|--------------|
| J5206HS | 3/16 | 5/8 | 3/4 | 0.04 |
| J5208HS | 1/4 | 5/8 | 13/16 | 0.03 |
| J5210HS | 5/16 | 5/8 | 3/4 | 0.03 |
| J5212HS | 3/8 | 5/8 | 3/4 | 0.04 |
| J5214HS | 7/16 | 3/4 | 7/8 | 0.04 |
| J5216HS | 1/2 | 3/4 | 7/8 | 0.05 |
| J5218HS | 9/16 | 3/4 | 7/8 | 0.17 |
| J5220HS | 5/8 | 7/8 | 15/16 | 0.09 |
| J5222HS | 11/16 | 15/16 | 15/16 | 0.09 |
| J5224HS | 3/4 | 15/16 | 15/16 | 0.11 |

3/8" DRIVE SOCKETS - 8 POINT

- › For square fasteners.



| Product # | Size (in) (A) | Nut End Outside Dia. (in) (B) | Drive End Outside Dia. (in) (C) | Nut Depth (in) (D) | Bolt Clearance Depth (in) (E) | Overall Length (in) (L) | Weight (lbs) |
|-----------|---------------|-------------------------------|---------------------------------|--------------------|-------------------------------|-------------------------|--------------|
| J5208S | 1/4 | 35/34 | 5/8 | 1/4 | 39/64 | 1-5/64 | 0.04 |
| J5210S | 5/16 | 9/16 | 5/8 | 1/4 | 39/64 | 1-5/64 | 0.05 |
| J5212S | 3/8 | 11/16 | 11/16 | 1/4 | 39/64 | 1-5/64 | 0.07 |
| J5214S | 7/16 | 3/4 | 3/4 | 17/64 | 39/64 | 1-5/64 | 0.08 |
| J5216S | 1/2 | 7/8 | 7/8 | 5/16 | 21/32 | 1-1/8 | 0.12 |



ASME B107.1

3/8" DRIVE SOCKETS - 12 POINT

- › Proto® 12 Point Sockets are ideal for use on stubborn or damaged fasteners, and also on fasteners made from soft materials.
- › TorquePlus™ features apply.



| Product # | Size (in) (A) | Nut End Outside Dia. (in) (B) | Drive End Outside Dia. (in) (C) | Nut Depth (in) (D) | Bolt Clearance Depth (in) (E) | Overall Length (in) (L) | Weight (lbs) |
|-----------|---------------|-------------------------------|---------------------------------|--------------------|-------------------------------|-------------------------|--------------|
| J5208 | 1/4 | 25/64 | 43/64 | 23/64 | 21/32 | 1-3/32 | 0.05 |
| J5209 | 9/32 | 27/64 | 43/64 | 21/32 | 21/32 | 1-3/32 | 0.05 |
| J5210 | 5/16 | 15/32 | 43/64 | 23/64 | 21/32 | 1-3/32 | 0.05 |
| J5211 | 11/32 | 1/2 | 43/64 | 23/64 | 21/32 | 1-3/32 | 0.05 |
| J5212 | 3/8 | 35/64 | 43/64 | 23/64 | 21/32 | 1-3/32 | 0.06 |
| J5214 | 7/16 | 41/64 | 43/64 | 23/64 | 21/32 | 1-3/32 | 0.06 |
| J5216 | 1/2 | 47/64 | 47/64 | 23/64 | 21/64 | 1-1/8 | 0.08 |
| J5217 | 17/32 | 49/64 | 49/64 | 23/64 | 11/16 | 1-1/8 | 0.08 |
| J5218 | 9/16 | 13/16 | 13/16 | 1/2 | 11/16 | 1-1/8 | 0.09 |
| J5219 | 19/32 | 33/64 | 27/32 | 1/2 | 11/16 | 1-1/8 | 0.09 |
| J5220 | 5/8 | 7/8 | 7/8 | 33/64 | 11/16 | 1-1/8 | 0.10 |
| J5222 | 11/16 | 61/64 | 61/64 | 17/32 | 11/16 | 1-1/8 | 0.13 |
| J5224 | 3/4 | 1-1/32 | 1-1/32 | 39/64 | 3/4 | 1-3/16 | 0.15 |
| J5225 | 25/32 | 1-1/16 | 1-1/16 | 39/64 | 3/4 | 1-3/16 | 0.16 |
| J5226 | 13/16 | 1-3/32 | 1-3/32 | 39/64 | 3/4 | 1-3/16 | 0.17 |
| J5228 | 7/8 | 1-3/16 | 1-3/16 | 41/64 | 7/8 | 1-5/16 | 0.24 |
| J5230 | 15/16 | 1-1/4 | 1-1/4 | 49/64 | 7/8 | 1-5/16 | 0.25 |
| J5232 | 1 | 1-5/16 | 1-5/16 | 13/16 | 59/64 | 1-3/8 | 0.27 |



AS954E S3.8.1

ASME B107.1

3/8" DRIVE METRIC SOCKETS - 12 POINT

- ▶ Proto® 12 Point Sockets are ideal for use on stubborn or damaged fasteners, and also on fasteners made from soft materials.
- ▶ TorquePlus™ features apply.



| Product # | Size (mm) (A) | Nut End Outside Dia. (in) (B) | Drive End Outside Dia. (in) (C) | Nut Depth (in) (D) | Bolt Clearance Depth (in) (E) | Overall Length (in) (L) | Weight (lbs) |
|-----------|---------------|-------------------------------|---------------------------------|--------------------|-------------------------------|-------------------------|--------------|
| J5206M | 6 | 25/64 | 43/64 | 1/4 | 45/64 | 1-3/32 | 0.05 |
| J5207M | 7 | 27/64 | 43/64 | 1/4 | 45/64 | 1-3/32 | 0.05 |
| J5208M | 8 | 15/32 | 43/64 | 1/4 | 45/64 | 1-3/32 | 0.06 |
| J5209M | 9 | 33/64 | 43/64 | 9/32 | 45/64 | 1-3/32 | 0.05 |
| J5210M | 10 | 19/32 | 43/64 | 5/16 | 45/64 | 1-3/32 | 0.06 |
| J5211M | 11 | 41/64 | 43/64 | 21/64 | 45/64 | 1-3/32 | 0.07 |
| J5212M | 12 | 45/64 | 45/64 | 9/32 | 1/2 | 1-1/8 | 0.05 |
| J5213M | 13 | 47/64 | 47/64 | 9/32 | 1/2 | 1-1/8 | 0.07 |
| J5214M | 14 | 25/32 | 25/32 | 15/32 | 7/16 | 1-1/8 | 0.08 |
| J5215M | 15 | 27/32 | 27/32 | 17/32 | 7/16 | 1-1/8 | 0.10 |
| J5216M | 16 | 55/64 | 55/64 | 17/32 | 7/16 | 1-1/8 | 0.10 |
| J5217M | 17 | 15/16 | 15/16 | 17/32 | 7/16 | 1-1/8 | 0.12 |
| J5218M | 18 | 61/64 | 61/64 | 17/32 | 1/2 | 1-3/16 | 0.12 |
| J5219M | 19 | 1 | 1 | 17/32 | 1/2 | 1-3/16 | 0.14 |
| J5220M | 20 | 1-3/32 | 1-3/32 | 5/8 | 1/2 | 1-3/16 | 0.17 |
| J5221M | 21 | 1-3/32 | 1-3/32 | 9/16 | 41/64 | 1-9/32 | 0.18 |
| J5222M | 22 | 1-11/64 | 1-11/64 | 43/64 | 5/8 | 1-5/16 | 0.22 |
| J5223M | 23 | 1-3/16 | 1-3/16 | 47/64 | 5/8 | 1-5/16 | 0.21 |
| J5224M | 24 | 1-1/4 | 1-1/4 | 49/64 | 37/64 | 1-5/16 | 0.23 |
| J5225M | 25 | 1-21/64 | 1-21/64 | 49/64 | 5/8 | 1-3/8 | 0.29 |
| J5226M | 26 | 1-21/64 | 1-21/64 | 49/64 | 59/64 | 1-3/8 | 0.26 |



AS954E S3.8.1

ASME B107.5M

3/8" DRIVE BLACK OXIDE SOCKETS - 12 POINT

- ▶ Proto® 12 Point Sockets are ideal for use on stubborn or damaged fasteners, and also on fasteners made from soft materials.
- ▶ TorquePlus™ features apply.



| Product # | Size (in) (A) | Nut End Outside Dia. (in) (B) | Drive End Outside Dia. (in) (C) | Nut Depth (in) (D) | Bolt Clearance Depth (in) (E) | Overall Length (in) (L) | Weight (lbs) |
|-----------|---------------|-------------------------------|---------------------------------|--------------------|-------------------------------|-------------------------|--------------|
| J5208B | 1/4 | 25/64 | 43/64 | 23/64 | 21/32 | 1-3/32 | 0.05 |
| J5210B | 5/16 | 29/64 | 43/64 | 11/32" | 39/64 | 1-3/32 | 0.06 |
| J5212B | 3/8 | 35/64 | 43/64 | 11/32 | 39/64 | 1-3/32 | 0.05 |
| J5214B | 7/16 | 21/32 | 43/64 | 11/32 | 39/64 | 1-3/32 | 0.06 |
| J5216B | 1/2 | 47/64 | 47/64 | 11/32 | 11/16 | 1-1/8 | 0.08 |
| J5218B | 9/16 | 51/64 | 51/64 | 33/64 | 11/16 | 1-1/8 | 0.09 |
| J5220B | 5/8 | 7/8 | 7/8 | 1/2 | 11/16 | 1-1/8 | 0.10 |
| J5222B | 11/16 | 61/64 | 61/64 | 9/16 | 5/8 | 1-1/8 | 0.13 |
| J5224B | 3/4 | 1-1/64 | 1-1/64 | 19/32 | 5/8 | 1-3/16 | 0.15 |
| J5226B | 13/16 | 1-5/64 | 1-5/64 | 5/8 | 5/8 | 1-7/16 | 0.17 |
| J5228B | 7/8 | 1-9/64 | 1-9/64 | 21/32 | 11/16 | 1-7/16 | 0.22 |
| J5230B | 15/16 | 1-15/64 | 1-9/64 | 23/32 | 11/16 | 1-9/16 | 0.23 |
| J5232B | 1 | 1-21/64 | 1-15/64 | 3/4 | 3/4 | 1-11/16 | 0.27 |



AS954E S3.8.1

ASME B107.1

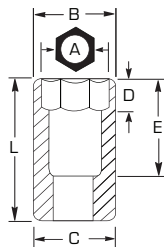



3/8" DRIVE DEEP SOCKETS - 12 POINT

- ▶ Proto® 12 Point Sockets are ideal for use on stubborn or damaged fasteners, and also on fasteners made from soft materials.
- ▶ TorquePlus™ features apply.



| Product # | Size (in) (A) | Nut End Outside Dia. (in) (B) | Drive End Outside Dia. (in) (C) | Nut Depth (in) (D) | Bolt Clearance Depth (in) (E) | Overall Length (in) (L) | Weight (lbs) |
|-----------|---------------|-------------------------------|---------------------------------|--------------------|-------------------------------|-------------------------|--------------|
| J5008 | 1/4 | 13/32 | 21/32 | 5/16 | 1-11/16 | 2-1/8 | 0.10 |
| J5010 | 5/16 | 15/32 | 21/32 | 13/32 | 1-11/16 | 2-1/8 | 0.10 |
| J5011 | 11/32 | 1/2 | 21/32 | 25/64 | 1-11/16 | 2-1/8 | 0.09 |
| J5012 | 1/4 | 35/64 | 21/32 | 13/32 | 1-11/16 | 2-1/8 | 0.10 |
| J5014 | 3/32 | 21/32 | 21/32 | 7/16 | 1-11/16 | 2-1/8 | 0.12 |
| J5016 | 1/2 | 23/32 | 23/32 | 33/64 | 1-11/16 | 2-1/8 | 0.14 |
| J5018 | 9/16 | 51/64 | 51/64 | 19/32 | 1-11/16 | 2-1/8 | 0.18 |
| J5020 | 5/8 | 7/8 | 7/8 | 43/64 | 2-5/16 | 2-3/4 | 0.24 |
| J5022 | 11/16 | 15/16 | 15/16 | 43/64 | 2-5/16 | 2-3/4 | 0.30 |
| J5024 | 3/4 | 1-1/64 | 1-1/64 | 43/64 | 2-5/16 | 2-3/4 | 0.33 |
| J5026 | 13/16 | 1-5/64 | 1-5/64 | 43/64 | 2-5/16 | 2-3/4 | 0.36 |
| J5028 | 7/8 | 1-15/64 | 1-15/64 | 1-3/16 | 2-5/16 | 2-3/4 | 0.43 |
| J5030 | 15/16 | 1-15/64 | 1-15/64 | 1-3/16 | 2-5/16 | 2-3/4 | 0.46 |
| J5032 | 1 | 1-5/16 | 1-5/16 | 1-3/16 | 2-5/16 | 2-3/4 | 0.54 |



AS954E S3.8.1

ASME B107.1

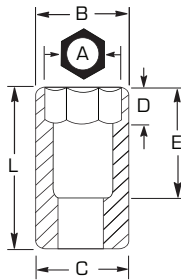

3/8" DRIVE METRIC DEEP SOCKETS - 12 POINT

METRIC

- ▶ Proto® 12 Point Sockets are ideal for use on stubborn or damaged fasteners, and also on fasteners made from soft materials.
- ▶ TorquePlus™ features apply.



| Product # | Size (mm) (A) | Nut End Outside Dia. (in) (B) | Drive End Outside Dia. (in) (C) | Nut Depth (in) (D) | Bolt Clearance Depth (in) (E) | Overall Length (in) (L) | Weight (lbs) |
|-----------|---------------|-------------------------------|---------------------------------|--------------------|-------------------------------|-------------------------|--------------|
| J5006M | 6 | 25/64 | 21/32 | 5/16 | 1-13/16 | 2-1/8 | 0.11 |
| J5007M | 7 | 25/64 | 21/32 | 25/64 | 1-47/64 | 2-1/8 | 0.09 |
| J5008M | 8 | 15/32 | 21/32 | 25/64 | 1-47/64 | 2-1/8 | 0.10 |
| J5009M | 9 | 33/64 | 21/32 | 25/64 | 1-47/64 | 2-1/8 | 0.11 |
| J5010M | 10 | 37/64 | 21/32 | 25/64 | 1-47/64 | 2-1/8 | 0.12 |
| J5011M | 11 | 21/32 | 7/16 | 1-11/16 | 1-47/64 | 2-1/8 | 0.13 |
| J5012M | 12 | 45/64 | 45/64 | 33/64 | 1-39/64 | 2-1/8 | 0.13 |
| J5013M | 13 | 23/32 | 23/32 | 33/64 | 1-39/64 | 2-1/8 | 0.13 |
| J5014M | 14 | 25/32 | 25/32 | 19/32 | 1-17/32 | 2-1/8 | 0.15 |
| J5015M | 15 | 55/64 | 55/64 | 21/32 | 2-7/64 | 2-3/4 | 0.15 |
| J5016M | 16 | 55/64 | 55/64 | 21/32 | 2-7/64 | 2-3/4 | 0.24 |
| J5017M | 17 | 15/16 | 15/16 | 21/32 | 2-7/64 | 2-3/4 | 0.27 |
| J5018M | 18 | 15/16 | 15/16 | 21/32 | 2-7/64 | 2-3/4 | 0.28 |
| J5019M | 19 | 1-1/64 | 1-1/64 | 11/16 | 2-1/16 | 2-3/4 | 0.30 |
| J5020M | 20 | 1-5/64 | 1-5/64 | 11/16 | 2-1/16 | 2-3/4 | 0.33 |
| J5021M | 21 | 1-5/64 | 1-5/64 | 11/16 | 2-1/16 | 2-3/4 | 0.34 |
| J5022M | 22 | 1-11/64 | 1-11/64 | 11/16 | 2-1/16 | 2-3/4 | 0.45 |
| J5023M | 23 | 1-7/32 | 1-11/64 | 1-3/16 | 1-37/64 | 2-3/4 | 0.54 |
| J5026M | 26 | 1-5/64 | 1-5/64 | 43/64 | 2-5/16 | 2-3/4 | 0.28 |



AS954E S3.8.1

ASME B107.5M



3/8" DRIVE DEEP BLACK OXIDE SOCKETS - 12 POINT

- › Black oxide finish - hand use only.
- › Proto® 12 Point Sockets are ideal for use on stubborn or damaged fasteners, and also on fasteners made from soft materials.
- › TorquePlus™ features apply.



| Product # | Size (in) (A) | Nut End Outside Dia. (in) (B) | Drive End Outside Dia. (in) (C) | Nut Depth (in) (D) | Bolt Clearance Depth (in) (E) | Overall Length (in) (L) | Weight (lbs) |
|-----------|---------------|-------------------------------|---------------------------------|--------------------|-------------------------------|-------------------------|--------------|
| J5012B | 3/8 | 35/64 | 21/32 | 25/64 | 1-3/8 | 2-1/8 | 0.10 |
| J5014B | 7/16 | 41/64 | 41/64 | 7/16 | 1-3/8 | 2-1/8 | 0.11 |
| J5016B | 1/2 | 23/32 | 23/32 | 33/64 | 1-3/8 | 2-1/8 | 0.13 |
| J5018B | 9/16 | 51/64 | 51/64 | 19/32 | 1-3/8 | 2-1/8 | 0.16 |
| J5020B | 5/8 | 7/8 | 7/8 | 43/64 | 2 | 2-3/4 | 0.26 |
| J5022B | 11/16 | 15/16 | 15/16 | 43/64 | 2 | 2-3/4 | 0.27 |
| J5024B | 3/4 | 1-1/64 | 1-1/64 | 43/64 | 2 | 2-3/4 | 0.33 |
| J5028B | 7/8 | 1-3/16 | 1-3/16 | 11/16 | 1-11/16 | 2-3/4 | 0.39 |
| J5026B | 13/16 | 1-5/64 | 1-5/64 | 43/64 | 2-5/64 | 2-3/4 | 0.25 |
| J5030B | 15/16 | 1-15/16 | 1-15/16 | 11/16 | 2-5/16 | 2-3/4 | 0.42 |
| J5032B | 1 | 1-5/16 | 1-5/16 | 11/16 | 2-5/16 | 2-3/4 | 0.47 |



AS954E S3.8.1

ASME B107.1

3/8" DRIVE SOCKETS - SPLINE

- › Proto® Spline tools are designed to service high tensile strength fasteners used widely on military and commercial aircraft and in heavy machinery applications where vibration is prevalent. They are also used in automotive and industrial areas where high performance torque needs to be achieved.
- › Spline sockets help tighten high-strength bolts to high torque loads. They help lower the force required to turn standard fasteners by allowing the torque load to be moved away from the corners to help prevent fastener rounding. They also turn fasteners with damaged corners.
- › Spline sockets on spline fasteners help deliver twice the torque of 12 point wrenches on double-box fasteners, and more torque than hex wrenches on hex fasteners.
- › Spline helps reduce foreign object debris (FOD) by having a precise fit between the fastening tool and its fastener.



| Product # | Size (in) (A) | Spline Size | Nut End Outside Dia. (in) (B) | Drive End Outside Dia. (in) (C) | Nut Depth (in) (D) | Bolt Clearance Depth (in) (E) | Overall Length (in) (L) | Weight (lbs) |
|-----------|---------------|-------------|-------------------------------|---------------------------------|--------------------|-------------------------------|-------------------------|--------------|
| J5212SPL | 3/8 | #12 | 9/16 | 21/32 | 3/8 | 11/16 | 1 | 0.06 |
| J5214SPL | 7/16 | #14 | 5/8 | 11/16 | 7/16 | 3/4 | 1-1/16 | 0.06 |
| J5216SPL | 1/2 | #16 | 3/4 | 23/32 | 7/16 | 3/4 | 1-1/16 | 0.07 |
| J5218SPL | 9/16 | #18 | 13/16 | 13/16 | 15/32 | 3/4 | 1-1/16 | 0.01 |
| J5220SPL | 5/8 | #20 | 7/8 | 7/8 | 17/32 | 7/8 | 1-3/16 | 0.13 |



3/8" DRIVE DEEP SOCKETS - SPLINE

- › Proto® Spline tools are designed to service high tensile strength fasteners used widely on military and commercial aircraft and in heavy machinery applications where vibration is prevalent. They are also used in automotive and industrial areas where high performance torque needs to be achieved.
- › Spline sockets help tighten high-strength bolts to high torque loads. They help lower the force required to turn standard fasteners by allowing the torque load to be moved away from the corners to help prevent fastener rounding. They also turn fasteners with damaged corners.
- › Spline sockets on spline fasteners help deliver twice the torque of 12 point wrenches on double-box fasteners, and more torque than hex wrenches on hex fasteners.
- › Spline helps reduce foreign object debris (FOD) by having a precise fit between the fastening tool and its fastener.



| Product # | Size (in) (A) | Spline Size | Nut End Outside Dia. (in) (B) | Drive End Outside Dia. (in) (C) | Nut Depth (in) (D) | Bolt Clearance Depth (in) (E) | Overall Length (in) (L) | Weight (lbs) |
|-----------|---------------|-------------|-------------------------------|---------------------------------|--------------------|-------------------------------|-------------------------|--------------|
| J5012DPL | 3/8 | #12 | 9/16 | 21/32 | 3/8 | 1-5/8 | 2-1/8 | 0.08 |
| J5014DPL | 7/16 | #14 | 5/8 | 11/16 | 7/16 | 1-5/8 | 2-1/8 | 0.10 |
| J5016DPL | 1/2 | #16 | 3/4 | 23/32 | 7/16 | 1-5/8 | 2-1/8 | 0.12 |
| J5018DPL | 9/16 | #18 | 13/16 | 13/16 | 15/32 | 1-7/8 | 2-3/8 | 0.19 |
| J5020DPL | 5/8 | #22 | 7/8 | 7/8 | 17/32 | 1-7/8 | 2-3/8 | 0.22 |



3/8" DRIVE UNIVERSAL SOCKETS - 6 POINT

- › Proto® 6 Point Sockets are ideal for use on stubborn or damaged fasteners, and also on fasteners made from soft materials.
- › TorquePlus™ features apply.



| Product # | Size (in) (A) | Nut End Outside Dia. (in) (B) | Drive End Outside Dia. (in) (C) | Nut Depth (in) (D) | Bolt Clearance Depth (in) (E) | Overall Length (in) (L) | Weight (lbs) |
|-----------|---------------|-------------------------------|---------------------------------|--------------------|-------------------------------|-------------------------|--------------|
| J5272HA | 5/16 | 15/32 | 23/32 | 5/16 | 27/64 | 1-3/4 | 0.10 |
| J5273HA | 3/8 | 35/64 | 23/32 | 5/16 | 27/64 | 1-3/4 | 0.11 |
| J5274HA | 7/16 | 41/64 | 23/32 | 3/8 | 27/64 | 1-3/4 | 0.10 |
| J5275HA | 1/2 | 23/32 | 23/32 | 11/32 | 33/64 | 1-3/4 | 0.10 |
| J5276HA | 9/16 | 25/32 | 23/32 | 3/8 | 17/32 | 1-27/32 | 0.11 |
| J5277HA | 5/8 | 7/8 | 23/32 | 3/8 | 39/64 | 1-27/32 | 0.15 |
| J5278HA | 11/16 | 31/32 | 23/32 | 7/16 | 5/8 | 1-7/8 | 0.15 |
| J5279HA | 3/4 | 1 | 23/32 | 7/16 | 43/64 | 1-7/8 | 0.14 |



ASME B107.1

3/8" DRIVE METRIC UNIVERSAL SOCKETS - 6 POINT

- › Proto® 6 Point Sockets are ideal for use on stubborn or damaged fasteners, and also on fasteners made from soft materials.
- › TorquePlus™ features apply.



METRIC



| Product # | Size (mm) (A) | Nut End Outside Dia. (in) (B) | Drive End Outside Dia. (in) (C) | Nut Depth (in) (D) | Bolt Clearance Depth (in) (E) | Overall Length (in) (L) | Weight (lbs) |
|-----------|---------------|-------------------------------|---------------------------------|--------------------|-------------------------------|-------------------------|--------------|
| J5270HAM | 7 | 27/64 | 23/32 | 5/16 | 7/16 | 1-49/64 | 0.11 |
| J5271HAM | 8 | 29/64 | 23/32 | 5/16 | 7/16 | 1-49/64 | 0.04 |
| J5273HAM | 10 | 35/64 | 23/32 | 11/32 | 7/16 | 1-49/64 | 0.11 |
| J5274HAM | 11 | 19/32 | 23/32 | 11/32 | 7/16 | 1-49/64 | 0.11 |
| J5275HAM | 12 | 21/32 | 23/32 | 11/32 | 7/16 | 1-49/64 | 0.10 |
| J5276HAM | 13 | 23/32 | 23/32 | 11/32 | 7/16 | 1-49/64 | 0.10 |
| J5277HAM | 14 | 25/32 | 23/32 | 3/8 | 31/64 | 1-7/8 | 0.11 |
| J5278HAM | 15 | 51/64 | 23/32 | 3/8 | 31/64 | 1-7/8 | 0.12 |
| J5279HAM | 16 | 55/64 | 23/32 | 13/32 | 33/64 | 1-57/64 | 0.15 |
| J5280HAM | 17 | 15/16 | 23/32 | 13/32 | 33/64 | 1-57/64 | 0.15 |
| J5281HAM | 18 | 63/64 | 23/32 | 7/16 | 33/64 | 1-57/64 | 0.15 |
| J5282HAM | 19 | 1-1/64 | 23/32 | 15/32 | 17/32 | 1-59/64 | 0.16 |



ASME B107.5M

3/8" DRIVE DEEP UNIVERSAL SOCKETS - 6 POINT

- › Universal sockets permit turning at an angle up to 65° where obstructions may prevent a straight application.
- › Proto® 6 Point Sockets are ideal for use on stubborn or damaged fasteners, and also on fasteners made from soft materials.



| Product # | Size (in) (A) | Nut End Outside Dia. (in) (B) | Drive End Outside Dia. (in) (C) | Nut Depth (in) (D) | Bolt Clearance Depth (in) (E) | Overall Length (in) (L) | Weight (lbs) |
|-----------|---------------|-------------------------------|---------------------------------|--------------------|-------------------------------|-------------------------|--------------|
| J5274LHA | 7/16 | 5/8 | 23/32 | 11/32 | 1-1/8 | 1-3/8 | 0.16 |
| J5275LHA | 1/2 | 23/32 | 23/32 | 3/4 | 1-1/8 | 1-3/8 | 0.16 |
| J5276LHA | 9/16 | 25/32 | 23/32 | 3/4 | 1-31/32 | 2-3/8 | 0.18 |
| J5277LHA | 5/8 | 7/8 | 23/32 | 3/4 | 1-31/32 | 2-3/8 | 0.19 |





3/8" DRIVE UNIVERSAL SOCKETS - 12 POINT

- › Proto® 12 Point Sockets are ideal for use on stubborn or damaged fasteners, and also on fasteners made from soft materials.
- › TorquePlus™ features apply.



| Product # | Size (in) (A) | Nut End Outside Dia. (in) (B) | Drive End Outside Dia. (in) (C) | Nut Depth (in) (D) | Bolt Clearance Depth (in) (E) | Overall Length (in) (L) | Weight (lbs) |
|-----------|---------------|-------------------------------|---------------------------------|--------------------|-------------------------------|-------------------------|--------------|
| J5272A | 5/16 | 15/32 | 23/32 | 5/16 | 27/64 | 1-3/4 | 0.10 |
| J5273A | 3/8 | 35/64 | 23/32 | 11/32" | 27/64 | 1-3/4 | 0.11 |
| J5274A | 7/16 | 41/64 | 23/32 | 3/8 | 27/64 | 1-3/4 | 0.11 |
| J5275A | 1/2 | 23/32 | 23/32 | 11/32 | 33/64 | 1-3/4 | 0.11 |
| J5276A | 9/16 | 25/32 | 25/32 | 3/8 | 17/32 | 1-27/32 | 0.15 |
| J5277A | 5/8 | 7/8 | 7/8 | 3/8 | 39/64 | 1-27/32 | 0.17 |
| J5278A | 11/16 | 31/32 | 7/8 | 7/16 | 5/8 | 1-7/8 | 0.19 |
| J5279A | 3/4 | 1 | 7/8 | 7/16 | 43/64 | 1-7/8 | 0.23 |
| J5280A | 13/16 | 1-3/32 | 25/32 | 13/32 | 9/16 | 1-7/8 | 0.27 |
| J5281A | 7/8 | 1-3/16 | 25/32 | 17/32 | 5/8 | 1-61/64 | 0.31 |
| J5282A | 15/16 | 1-1/4 | 25/32 | 17/32 | 5/8 | 1-61/64 | 0.35 |
| J5283A | 1 | 1-11/32 | 25/32 | 9/16 | 45/64 | 2 | 0.39 |



AS954E S3.8.1

ASME B107.1

3/8" DRIVE METRIC UNIVERSAL SOCKETS - 12 POINT

METRIC

- › Proto® 12 Point Sockets are ideal for use on stubborn or damaged fasteners, and also on fasteners made from soft materials.
- › TorquePlus™ features apply.



| Product # | Size (mm) (A) | Nut End Outside Dia. (in) (B) | Drive End Outside Dia. (in) (C) | Nut Depth (in) (D) | Bolt Clearance Depth (in) (E) | Overall Length (in) (L) | Weight (lbs) |
|-----------|---------------|-------------------------------|---------------------------------|--------------------|-------------------------------|-------------------------|--------------|
| J5272AM | 9 | 33/64 | 23/32 | 5/16 | 25/64 | 1-3/4 | 0.10 |
| J5273AM | 10 | 35/64 | 23/32 | 11/32 | 25/64 | 1-3/4 | 0.10 |
| J5274AM | 11 | 19/32 | 23/32 | 11/32 | 25/64 | 1-3/4 | 0.12 |
| J5275AM | 12 | 21/32 | 23/32 | 11/32 | 1/2 | 1-3/4 | 0.10 |
| J5276AM | 13 | 23/32 | 23/32 | 11/32 | 1/2 | 1-3/4 | 0.11 |
| J5277AM | 14 | 25/32 | 23/32 | 3/8 | 33/64 | 1-7/8 | 0.13 |
| J5278AM | 15 | 13/16 | 23/32 | 3/8 | 41/64 | 1-7/8 | 0.12 |
| J5279AM | 16 | 55/64 | 23/32 | 13/32 | 33/64 | 1-57/64 | 0.12 |
| J5280AM | 17 | 15/16 | 23/32 | 7/16 | 33/64 | 1-57/64 | 0.15 |
| J5281AM | 18 | 63/64 | 23/32 | 7/16 | 33/64 | 1-57/64 | 0.16 |
| J5282AM | 19 | 63/64 | 23/32 | 15/32 | 17/32 | 1-59/64 | 0.15 |



ASME B107.5M

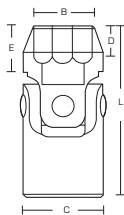
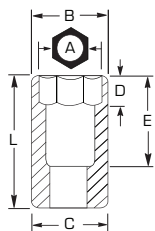

3/8" DRIVE SPARK PLUG SOCKETS - 6 POINT

- › With rubber insert.



| Product # | Size (in) (A) | Nut End Outside Dia. (in) (B) | Overall Length (in) (L) | Weight (lbs) |
|-----------|---------------|-------------------------------|-------------------------|--------------|
| J5020-50 | 5/8 | 3/16 | 2-1/2 | 0.21 |
| J5026HPA | 13/16 | 19/64 | 2-3/4 | 0.35 |



3/8" DRIVE UNIVERSAL SPARK PLUG SOCKETS - 6 POINT

- ▶ With rubber insert.



| Product # | Size (in) (A) | Nut End Outside Dia. (in) (B) | Drive End Outside Dia. (in) (C) | Nut Depth (in) (D) | Overall Length (in) (L) | Weight (lbs) |
|------------------|---------------|-------------------------------|---------------------------------|--------------------|-------------------------|--------------|
| J5020-70A | 5/8 | 27/32 | 23/32 | 5/16 | 3-19/64 | 0.26 |
| J5026-50A | 13/16 | 1-1/16 | 23/32 | 5/16 | 3-3/8 | 0.34 |

3/8" DRIVE DRAG LINK SOCKET

| Product # | Size (in) | Tip Width (in) | Overall Length (in) | Weight (lbs) |
|--------------|-----------|----------------|---------------------|--------------|
| J5244 | 11/16 | 1/8 | 1-1/8 | 0.06 |



3/8" DRIVE SLOTTED SCREWDRIVER BIT SOCKETS

| Product # | Tip Size | Tip Width (in) | Overall Length (in) | Weight (lbs) |
|---------------|----------|----------------|---------------------|--------------|
| J5246 | 1/4 | 1/32 | 1-13/16 | 0.01 |
| J5240A | 5/16 | 3/64 | 3 | 0.13 |



3/8" DRIVE PHILLIPS® SCREWDRIVER BIT SOCKETS

- ▶ Two piece design allows replacement of worn bits.
- ▶ Bit holders have a hex opening to hold the bit allowing the bit holder to take the full load of torque.

| Product # | Tip Size | Overall Length (in) | Weight (lbs) |
|--------------|----------|---------------------|--------------|
| J5241 | #2 | 1-31/32 | 0.11 |
| J5242 | #3 | 1-31/32 | 0.12 |
| J5243 | #4 | 1-31/32 | 0.12 |



3/8" DRIVE TORX® SCREWDRIVER BIT SOCKETS

| Product # | Torx® Size | Bit Length (in) | Overall Length (in) | Weight (lbs) |
|------------------|------------|-----------------|---------------------|--------------|
| J5239-10W | T10 | 5/8 | 1-23/32 | 0.10 |
| J5239-15W | T15 | 5/8 | 1-23/32 | 0.10 |
| J5239-20W | T20 | 5/8 | 1-23/32 | 0.10 |
| J5239-25W | T25 | 5/8 | 1-23/32 | 0.10 |
| J5239-27W | T27 | 5/8 | 1-23/32 | 0.10 |
| J5239-30W | T30 | 7/8 | 1-23/32 | 0.12 |
| J5239-40W | T40 | 7/8 | 1-23/32 | 0.11 |
| J5239-45W | T45 | 7/8 | 1-23/32 | 0.12 |
| J5239-50W | T50 | 7/8 | 1-23/32 | 0.12 |
| J5239-55W | T55 | 7/8 | 1-23/32 | 0.13 |



3/8" DRIVE HEX BIT SOCKETS

- › Made using a heat-treated alloy for wear-resistance which helps minimize distortion for a long life.
- › Hex opening holds the bit allowing the bit holder to take the torque load.

| Product # | Size (in) | Bit Length (in) | Overall Length (in) | Weight (lbs) |
|-----------|-----------|-----------------|---------------------|--------------|
| J49901/8 | 1/8 | 1-5/8 | 2-23/32 | 0.12 |
| J49905/32 | 5/32 | 1-5/8 | 2-23/32 | 0.12 |
| J49903/16 | 3/16 | 1-5/8 | 2-23/32 | 0.12 |
| J49907/32 | 7/32 | 1-5/8 | 2-23/32 | 0.12 |
| J49901/4 | 1/4 | 1-5/8 | 2-23/32 | 0.12 |
| J49905/16 | 5/16 | 1-5/8 | 2-23/32 | 0.13 |
| J49903/8 | 3/8 | 1-5/8 | 2-23/32 | 0.15 |



3/8" DRIVE SHORT HEX BIT SOCKETS

- › Made using a heat-treated alloy for wear-resistance which helps minimize distortion for a long life.
- › Hex opening holds the bit allowing the bit holder to take the torque load.

| Product # | Size (in) | Bit Length (in) | Overall Length (in) | Weight (lbs) |
|-------------|-----------|-----------------|---------------------|--------------|
| J49901/8ST | 1/8 | 3/4 | 1-13/16 | 0.10 |
| J49905/32ST | 5/32 | 3/4 | 1-13/16 | 0.11 |
| J49903/16ST | 3/16 | 3/4 | 1-13/16 | 0.10 |
| J49907/32ST | 7/32 | 3/4 | 1-13/16 | 0.10 |
| J49901/4ST | 1/4 | 3/4 | 1-13/16 | 0.11 |
| J49905/16ST | 5/16 | 3/4 | 1-13/16 | 0.11 |
| J49903/8ST | 3/8 | 3/4 | 1-13/16 | 0.12 |



3/8" DRIVE EXTRA-LONG HEX BIT SOCKETS

- › Made using a heat-treated alloy for wear-resistance which helps minimize distortion for a long life.

| Product # | Size (in) | Bit Length (in) | Overall Length (in) | Weight (lbs) |
|-------------|-----------|-----------------|---------------------|--------------|
| J49901/8XL | 1/8 | 5 | 6-3/32 | 0.08 |
| J49905/32XL | 5/32 | 5 | 6-3/32 | 0.12 |
| J49903/16XL | 3/16 | 5 | 6-3/32 | 0.12 |
| J49907/32XL | 7/32 | 5 | 6-3/32 | 0.13 |
| J49901/4XL | 1/4 | 5 | 6-3/32 | 0.17 |
| J49905/16XL | 5/16 | 5 | 6-3/32 | 0.21 |
| J49903/8XL | 3/8 | 5 | 6-3/32 | 0.26 |



3/8" DRIVE BALL END EXTRA-LONG HEX BIT SOCKETS

- › Ball style head to turn a hex fastener at different angles in hard to reach places.
- › Made of alloy steel.
- › Polished chrome finish socket.

| Product # | Size (in) | Bit Length (in) | Overall Length (in) | Weight (lbs) |
|-----------|-----------|-----------------|---------------------|--------------|
| J4904BD | 1/8 | 5 | 6-3/32 | 0.19 |
| J4905BD | 5/32 | 5 | 6-3/32 | 0.17 |
| J4906BD | 3/16 | 5 | 6-3/32 | 0.17 |
| J4907BD | 7/32 | 5 | 6-3/32 | 0.16 |
| J4908BD | 1/4 | 5 | 6-3/32 | 0.17 |
| J4910BD | 5/16 | 5 | 6-3/32 | 0.22 |
| J4912BD | 3/8 | 5 | 6-3/32 | 0.28 |





3/8" DRIVE METRIC HEX BIT SOCKETS



- › Made using a heat-treated alloy for wear-resistance which helps minimize distortion for a long life.
- › Hex opening holds the bit allowing the bit holder to take the torque load.

| Product # | Size (mm) | Bit Length (in) | Overall Length (in) | Weight (lbs) |
|-----------|-----------|-----------------|---------------------|--------------|
| J4990-4M | 4 | 1-5/8 | 2-23/32 | 0.12 |
| J4990-5M | 5 | 1-5/8 | 2-23/32 | 0.12 |
| J4990-6M | 6 | 1-5/8 | 2-23/32 | 0.12 |
| J4990-7M | 7 | 1-5/8 | 2-23/32 | 0.12 |
| J4990-8M | 8 | 1-5/8 | 2-23/32 | 0.13 |
| J4990-9M | 9 | 1-5/8 | 2-23/32 | 0.15 |
| J4990-10M | 10 | 1-5/8 | 2-23/32 | 0.16 |



3/8" DRIVE METRIC SHORT HEX BIT SOCKETS



- › Made of alloy steel. Polished chrome finish.
- › Made using a heat-treated alloy for wear-resistance which helps minimize distortion for a long life.
- › Hex opening holds the bit allowing the bit holder to take the torque load.

| Product # | Size (mm) | Bit Length (in) | Overall Length (in) | Weight (lbs) |
|-------------|-----------|-----------------|---------------------|--------------|
| J4990-4MST | 4 | 11/16 | 1-25/32 | 0.08 |
| J4990-5MST | 5 | 11/16 | 1-25/32 | 0.10 |
| J4990-6MST | 6 | 11/16 | 1-25/32 | 0.10 |
| J4990-7MST | 7 | 11/16 | 1-25/32 | 0.11 |
| J4990-8MST | 8 | 11/16 | 1-25/32 | 0.10 |
| J4990-9MST | 9 | 11/16 | 1-25/32 | 0.11 |
| J4990-10MST | 10 | 11/16 | 1-25/32 | 0.12 |



3/8" DRIVE METRIC EXTRA-LONG HEX BIT SOCKETS



- › Made using a heat-treated alloy for wear-resistance which helps minimize distortion for a long life.

| Product # | Size (mm) | Bit Length (in) | Overall Length (in) | Weight (lbs) |
|-------------|-----------|-----------------|---------------------|--------------|
| J4990-4MXL | 4 | 13/64 | 6-3/32 | 0.10 |
| J4990-5MXL | 5 | 13/64 | 6-3/32 | 0.17 |
| J4990-6MXL | 6 | 13/64 | 6-3/32 | 0.17 |
| J4990-7MXL | 7 | 13/64 | 6-3/32 | 0.17 |
| J4990-8MXL | 8 | 13/64 | 6-3/32 | 0.21 |
| J4990-10MXL | 10 | 13/64 | 6-3/32 | 0.28 |



3/8" DRIVE CROWFOOT WRENCHES

| Product # | Size (in) | Overall Length (in) | Weight (lbs) |
|-----------|-----------|---------------------|--------------|
| J4912CF | 3/8 | 1-13/64 | 0.06 |
| J4914CF | 7/16 | 1-3/16 | 0.06 |
| J4916CF | 1/2 | 1-5/16 | 0.07 |
| J4918CF | 9/16 | 1-9/32 | 0.07 |
| J4920CF | 5/8 | 1-1/2 | 0.09 |
| J4922CF | 11/16 | 1-31/64 | 0.09 |
| J4924CF | 3/4 | 1-41/64 | 0.11 |
| J4926CF | 13/16 | 1-5/8 | 0.11 |
| J4928CF | 7/8 | 1-19/32 | 0.12 |
| J4930CF | 15/16 | 1-5/8 | 0.13 |
| J4932CF | 1 | 1-49/64 | 0.13 |
| J4934CF | 1-1/16 | 2-3/16 | 0.24 |
| J4936CF | 1-1/8 | 2-7/32 | 0.24 |
| J4938CF | 1-3/16 | 2-9/32 | 0.24 |
| J4940CF | 1-1/4 | 2-5/32 | 0.21 |
| J4942CF | 1-5/16 | 2-1/2 | 0.25 |
| J4944CF | 1-3/8 | 2-1/2 | 0.29 |
| J4946CF | 1-7/16 | 2-5/8 | 0.29 |
| J4948CF | 1-1/2 | 2-11/16 | 0.33 |
| J4950CF | 1-9/16 | 2-3/4 | 0.34 |
| J4952CF | 1-5/8 | 2-13/16 | 0.38 |
| J4954CF | 1-11/16 | 2-15/16 | 0.36 |
| J4956CF | 1-3/4 | 2-15/16 | 0.39 |
| J4958CF | 1-13/16 | 3-1/16 | 0.40 |
| J4960CF | 1-7/8 | 3-1/8 | 0.45 |
| J4962CF | 1-15/16 | 3-1/4 | 0.49 |
| J4964CF | 2 | 3-3/8 | 0.73 |
| J4966CF | 2-1/16 | 3-7/16 | 0.71 |
| J4968CF | 2-1/8 | 3-7/16 | 0.74 |
| J4970CF | 2-3/16 | 3-5/8 | 0.78 |
| J4972CF | 2-1/4 | 3-11/16 | 0.89 |
| J4974CF | 2-5/16 | 3-3/4 | 0.90 |
| J4976CF | 2-3/8 | 3-15/16 | 1.01 |
| J4978CF | 2-7/16 | 4-1/4 | 1.03 |
| J4980CF | 2-1/2 | 4-1/4 | 1.10 |
| J4982CF | 2-9/16 | 4-5/16 | 1.11 |
| J4984CF | 2-5/8 | 4-1/2 | 1.27 |
| J4986CF | 2-11/16 | 4-9/16 | 1.34 |
| J4988CF | 2-3/4 | 4-11/16 | 1.37 |
| J4990CF | 2-13/16 | 4-13/16 | 1.38 |
| J4992CF | 2-7/8 | 4-15/16 | 1.52 |
| J4994CF | 2-15/16 | 4-15/16 | 1.58 |
| J4996CF | 3 | 5 | 1.55 |



- Crowfoot wrenches are used in hard to reach, restricted access situations where a standard wrench or ratchet cannot reach.
- Anti-Slip Design Open End (ASD).
- The arched surfaces are designed to spread the contact forces over a greater area and they keep the loads off the corners of the fastener which helps prevent fastener rounding.
- Broad size range ensures the right tool for the application will be available.
- Typically used in lower torque applications.
- Full Polish finish provides corrosion resistance and easy to clean surfaces.
- Locking hole on 3/8" drive crowfoot wrenches available on fractional openings 1" and larger.

 ASME B107.21

FEATURES AND BENEFITS — ANTI-SLIP DESIGN (ASD)

Crowfoot Wrenches may feel somewhat loose going onto the fastener.

However, when it turns and the groove engages with the corner of the fastener, the fit will be very precise.

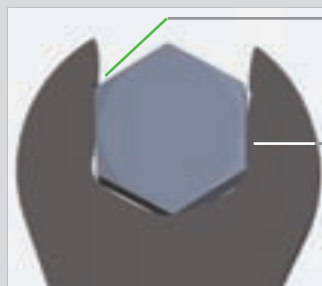

The notch locks the fastener head into position.

The curved jaw holds the fastener tightly.

3/8" DRIVE METRIC CROWFOOT WRENCHES



- › Crowfoot wrenches are used in hard to reach, restricted access situations where a standard wrench or ratchet cannot reach.
- › Anti-Slip Design Open End (ASD).
- › The arched surfaces are designed to spread the contact forces over a greater area and they keep the loads off the corners of the fastener which helps prevent fastener rounding.
- › Broad size range ensures the right tool for the application will be available.
- › Typically used in lower torque applications.
- › Full Polish finish provides corrosion resistance and easy to clean surfaces.
- › Locking hole feature helps keep the crowfoot wrench engaged on the extension during use reducing downtime due to detachment of crowfoot in awkward spaces.
- › Use with locking extensions to reach into spaces too small for a mechanic's arm or where the fastener is out of site.
- › Locking hole on 3/8" drive crowfoot wrenches available on fractional openings 1" and larger.

| Product # | Overall Length | | Weight (lbs) |
|-----------|----------------|---------|--------------|
| | Size (mm) | (in) | |
| J4909MCF | 9 | 1-5/6 | 0.05 |
| J4910MCF | 10 | 1-11/32 | 0.05 |
| J4911MCF | 11 | 1-3/8 | 0.07 |
| J4912MCF | 12 | 1-15/32 | 0.07 |
| J4913MCF | 13 | 1-1/2 | 0.06 |
| J4914MCF | 14 | 1-1/2 | 0.07 |
| J4915MCF | 15 | 1-5/8 | 0.10 |
| J4916MCF | 16 | 1-21/32 | 0.09 |
| J4917MCF | 17 | 1-23/32 | 0.10 |
| J4918MCF | 18 | 1-15/16 | 0.13 |
| J4919MCF | 19 | 1-15/16 | 0.13 |
| J4920MCF | 20 | 2-1/16 | 0.13 |
| J4921MCF | 21 | 2-3/32 | 0.14 |
| J4922MCF | 22 | 2-7/32 | 0.15 |
| J4923MCF | 23 | 2-11/32 | 0.19 |
| J4924MCF | 24 | 2-13/32 | 0.19 |



ASME B107.21



3/8" DRIVE FLARE NUT CROWFOOT WRENCHES - 6 POINT

- › Flare Nut Crowfoot wrenches are used in hard to reach or restricted access situations where a standard flare nut wrench cannot reach.
- › The flare nut slot opening is used to slide over hydraulic lines or other hoses which allows for easy access to hex connectors at ends.
- › Typically used in low torque applications.
- › Full polish finish provides corrosion resistance and easy to clean surfaces.
- › Locking hole feature helps keep the crowfoot engaged on the extension during use, helping to reduce downtime and improve working efficiency.
- › Use with locking extensions to reach into small spaces where the fastener is out of sight.

| Product # | Overall Length | | Weight (lbs) |
|-----------|----------------|---------|--------------|
| | Size (in) | (in) | |
| J4912HFL | 3/8 | 1-13/16 | 0.07 |
| J4914HFL | 7/16 | 1-1/2 | 0.08 |
| J4916HFL | 1/2 | 1-5/8 | 0.10 |
| J4918HFL | 9/16 | 1-5/8 | 0.11 |
| J4920HFL | 5/8 | 1-3/4 | 0.13 |
| J4922HFL | 11/16 | 1-13/16 | 0.13 |
| J4924HFL | 3/4 | 1-15/16 | 0.16 |
| J4926HFL | 13/16 | 2 | 0.18 |





3/8" DRIVE METRIC FLARE NUT CROWFOOT WRENCHES - 6 POINT



- › Flare Nut Crowfoot wrenches are used in hard to reach or restricted access situations where a standard flare nut wrench cannot reach.
- › The flare nut slot opening is used to slide over hydraulic lines or other hoses which allows for easy access to hex connectors at ends.
- › Typically used in low torque applications.
- › Full polish finish provides corrosion resistance and easy to clean surfaces.
- › Locking hole feature helps keep the crowfoot engaged on the extension during use, helping to reduce downtime and improve working efficiency.
- › Use with locking extensions to reach into small spaces where the fastener is out of sight.

| Product # | Size (mm) | Overall Length (in) | Weight (lbs) |
|------------------|-----------|---------------------|--------------|
| J4909MHFL | 9 | 1-5/16 | 0.07 |
| J4910MHFL | 10 | 1-3/8 | 0.07 |
| J4911MHFL | 11 | 1-1/2 | 0.08 |
| J4912MHFL | 12 | 1-1/2 | 0.08 |
| J4913MHFL | 13 | 1-9/16 | 0.09 |
| J4914MHFL | 14 | 1-5/8 | 0.11 |
| J4915MHFL | 15 | 1-11/16 | 0.11 |
| J4916MHFL | 16 | 1-3/4 | 0.12 |
| J4917MHFL | 17 | 1-3/4 | 0.13 |
| J4918MHFL | 18 | 1-13/16 | 0.14 |



3/8" DRIVE FLARE NUT CROWFOOT WRENCHES - 12 POINT

- › Designed for speed and safety.
- › Special heat-treated alloy steel helps increase strength and durability.
- › 12 point box end allows for fine indexing, helping to improve speed and access. Fits 4, 6 and 12 point fasteners.
- › Full Polish finish provides corrosion resistance and easy to clean surfaces.
- › Locking hole helps hold crowfoot in place during use.
- › Use with a locking extension to help prevent tool loss in awkward locations.

| Product # | Size (in) (B) | Weight (lbs) |
|----------------|---------------|--------------|
| J4920FL | 5/8 | 0.09 |
| J4922FL | 11/16 | 0.10 |
| J4924FL | 3/4 | 0.12 |
| J4926FL | 13/16 | 0.12 |
| J4928FL | 7/8 | 0.16 |
| J4930FL | 15/16 | 0.17 |
| J4932FL | 1 | 0.18 |
| J4934FL | 1-1/16 | 0.20 |



ASME B107.21

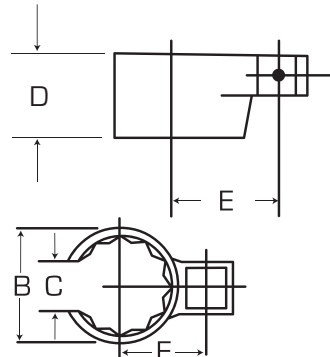

1/2" DRIVE 65 PIECE COMBINATION SOCKET SET - 8 AND 12 POINT

Product #: J54130

- ▶ 8 Point Standard: 3/8, 7/16, 1/2, 9/16, 5/8, 11/16, 3/4, 13/16, 7/8, 1 Inch.
- ▶ 12 Point Standard: 3/8, 7/16, 1/2, 9/16, 19/32, 5/8, 11/16, 3/4, 25/32, 13/16, 7/8, 29/32, 15/16, 1, 1-1/16, 1-1/8, 1-3/16, 1-1/4, 1-5/16, 1-3/8, 1-7/16, 1-1/2 Inch.
- ▶ 12 Point Deep: 1/2, 9/16, 5/8, 11/16, 3/4, 13/16, 7/8, 15/16, 1, 1-1/16, 1-1/8, 1-1/4 Inch.
- ▶ 12 Point Universal: 1/2, 9/16, 5/8 Inch.
- ▶ Bit Sockets: Hex 1/4, 5/16, 3/8, 7/16, 1/2, 9/16, 5/8 Inch
- ▶ Accessories: 1/2 Inch Drive Drag Link, Heavy-Duty Ratchet, Ratchet Adapter, Long Handle Ratchet, 2-1/2, 5, and 10 Inch Extensions, Hinge Handle, Universal Joint, Speed Handle, Sliding T-Handle.
- ▶ 4-Drawer Top Chest With Tray.
- ▶ Weight (lbs): 82.00



| Contents | Description | ASME Spec. | AS Spec. |
|----------|-------------------------------|-------------|---------------|
| J5412 | Socket, 1/2" DR 3/8" 12 PT | ASME B107.1 | AS954E S3.8.1 |
| J5414 | Socket, 1/2" DR 7/16" 12 PT | ASME B107.1 | AS954E S3.8.1 |
| J5416 | Socket, 1/2" DR 1/2" 12 PT | ASME B107.1 | AS954E S3.8.1 |
| J5418 | Socket, 1/2" DR 9/16" 12 PT | ASME B107.1 | AS954E S3.8.1 |
| J5419 | Socket, 1/2" DR 19/32" 12 PT | ASME B107.1 | AS954E S3.8.1 |
| J5420 | Socket, 1/2" DR 5/8" 12 PT | ASME B107.1 | AS954E S3.8.1 |
| J5422 | Socket, 1/2" DR 11/16" 12 PT | ASME B107.1 | AS954E S3.8.1 |
| J5424 | Socket, 1/2" DR 3/4" 12 PT | ASME B107.1 | AS954E S3.8.1 |
| J5425 | Socket, 1/2" DR 25/32" 12 PT | ASME B107.1 | AS954E S3.8.1 |
| J5426 | Socket, 1/2" DR 13/16" 12 PT | ASME B107.1 | AS954E S3.8.1 |
| J5428 | Socket, 1/2" DR 7/8" 12 PT | ASME B107.1 | AS954E S3.8.1 |
| J5429 | Socket, 1/2" DR 29/32" 12 PT | ASME B107.1 | AS954E S3.8.1 |
| J5430 | Socket, 1/2" DR 15/16" 12 PT | ASME B107.1 | AS954E S3.8.1 |
| J5432 | Socket, 1/2" DR 1" 12 PT | ASME B107.1 | AS954E S3.8.1 |
| J5434 | Socket, 1/2" DR 1-1/16" 12 PT | ASME B107.1 | AS954E S3.8.1 |
| J5436 | Socket, 1/2" DR 1-1/8" 12 PT | ASME B107.1 | AS954E S3.8.1 |
| J5438 | Socket, 1/2" DR 1-3/16" 12 PT | ASME B107.1 | AS954E S3.8.1 |
| J5440 | Socket, 1/2" DR 1-1/4" 12 PT | ASME B107.1 | AS954E S3.8.1 |
| J5442 | Socket, 1/2" DR 1-5/16" 12 PT | ASME B107.1 | AS954E S3.8.1 |

(CONTINUED ON NEXT PAGE)



1/2" DRIVE 65 PIECE COMBINATION SOCKET SET - 8 AND 12 POINT (CONTINUED)

| Contents | Description | ASME Spec. | AS Spec. |
|-----------------|--|-------------------|-----------------|
| J5444 | Socket, 1/2" DR 1-3/8" 12 PT | ASME B107.1 | AS954E S3.8.1 |
| J5446 | Socket, 1/2" DR 1-7/16" 12 PT | ASME B107.1 | AS954E S3.8.1 |
| J5448 | Socket, 1/2" DR 1-1/2" 12 PT | ASME B107.1 | AS954E S3.8.1 |
| J5316 | Socket, 1/2" DR 1/2" 12 PT Deep | ASME B107.1 | AS954E S3.8.1 |
| J5318 | Socket, 1/2" DR 9/16" 12 PT Deep | ASME B107.1 | AS954E S3.8.1 |
| J5320 | Socket, 1/2" DR 5/8" 12 PT Deep | ASME B107.1 | AS954E S3.8.1 |
| J5322 | Socket, 1/2" DR 11/16" 12 PT Deep | ASME B107.1 | AS954E S3.8.1 |
| J5324 | Socket, 1/2" DR 3/4" 12 PT Deep | ASME B107.1 | AS954E S3.8.1 |
| J5326 | Socket, 1/2" DR 13/16" 12 PT Deep | ASME B107.1 | AS954E S3.8.1 |
| J5328 | Socket, 1/2" DR 7/8" 12 PT Deep | ASME B107.1 | AS954E S3.8.1 |
| J5330 | Socket, 1/2" DR 15/16" 12 PT Deep | ASME B107.1 | AS954E S3.8.1 |
| J5332 | Socket, 1/2" DR 1" 12 PT Deep | ASME B107.1 | AS954E S3.8.1 |
| J5334 | Socket, 1/2" DR 1-1/16" 12 PT Deep | ASME B107.1 | AS954E S3.8.1 |
| J5336 | Socket, 1/2" DR 1-1/8" 12 PT Deep | ASME B107.1 | AS954E S3.8.1 |
| J5340 | Socket, 1/2" DR 1-1/4" 12 PT Deep | ASME B107.1 | AS954E S3.8.1 |
| J5475 | Socket, Universal 1/2" DR 1/2" 12 PT | ASME B107.1 | AS954E S3.8.1 |
| J5476 | Socket, Universal 1/2" DR 9/16" 12 PT | ASME B107.1 | AS954E S3.8.1 |
| J5477 | Socket, Universal 1/2" DR 5/8" 12 PT | ASME B107.1 | AS954E S3.8.1 |
| J5412S | Socket, 1/2" DR 3/8" 8 PT | ASME B107.1 | |
| J5414S | Socket, 1/2" DR 7/16" 8 PT | ASME B107.1 | |
| J5416S | Socket, 1/2" DR 1/2" 8 PT | ASME B107.1 | |
| J5418S | Socket, 1/2" DR 9/16" 8 PT | ASME B107.1 | |
| J5420S | Socket, 1/2" DR 5/8" 8 PT | ASME B107.1 | |
| J5422S | Socket, 1/2" DR 11/16" 8 PT | ASME B107.1 | |
| J5424S | Socket, 1/2" DR 3/4" 8 PT | ASME B107.1 | |
| J5426S | Socket, 1/2" DR 13/16" 8 PT | ASME B107.1 | |
| J5428S | Socket, 1/2" DR 7/8" 8 PT | ASME B107.1 | |
| J5432S | Socket, 1/2" DR 1" 8 PT | ASME B107.1 | |
| J54411/4 | Socket, Hex Bit 1/2" DR 1/4" | | |
| J54415/16 | Socket, Hex Bit 1/2" DR 5/16" | | |
| J54413/8 | Socket, Hex Bit 1/2" DR 3/8" | | |
| J54417/16 | Socket, Hex Bit 1/2" DR 7/16" | | |
| J54411/2 | Socket, Hex Bit 1/2" DR 1/2" | | |
| J54419/16 | Socket, Hex Bit 1/2" DR 9/16" | | |
| J54415/8 | Socket, Hex Bit 1/2" DR 5/8" | | |
| J5444A | Socket, 1/2" DR Drag Link 3/4" | | |
| J5470A | Socket, 1/2" DR Universal Joint | ASME B107.500 | |
| J5447 | Ratchet, Adapter 1/2" DR 2-21/32" | ASME B107.500 | |
| J5449 | Ratchet, 1/2" DR Standard Length Classic Pear Head 10" | ASME B107.500 | |
| J5450 | Ratchet, 1/2" DR Long Classic Pear Head 16" | ASME B107.500 | |
| J5460 | Extension, 1/2" DR 2-1/2" | ASME B107.500 | AS 4283 |
| J5461 | Extension, 1/2" DR 5" | ASME B107.500 | AS 4283 |
| J5463 | Extension, 1/2" DR 10" | ASME B107.500 | AS 4283 |
| J5468 | Handle, Hinge 1/2" DR 18-5/8" | ASME B107.500 | AS 4283 |
| J5480G | Handle, Speed 1/2" DR 18" | ASME B107.500 | |
| J5485 | Handle, Sliding T 1/2" DR 12-15/16" | ASME B107.500 | |
| J442715-4RD-D | 27" Chest with Drop Front Red | | |



1/2" DRIVE 65 PIECE COMBINATION SOCKET SET - 8 AND 12 POINT

Product #: J54132



- ▶ 8 Point Standard: 3/8, 7/16, 1/2, 9/16, 5/8, 11/16, 3/4, 13/16, 7/8, 1 Inch.
- ▶ 12 Point Standard: 3/8, 7/16, 1/2, 9/16, 19/32, 5/8, 11/16, 3/4, 25/32, 13/16, 7/8, 29/32, 15/16, 1, 1-1/16, 1-1/8, 1-3/16, 1-1/4, 1-5/16, 1-3/8, 1-7/16, 1-1/2 Inch.
- ▶ 12 Point Deep: 1/2, 9/16, 5/8, 11/16, 3/4, 13/16, 7/8, 15/16, 1, 1-1/16, 1-1/8, 1-1/4 Inch.
- ▶ 12 Point Universal: 1/2, 9/16, 5/8 Inch.
- ▶ Bit Sockets: Hex 1/4, 5/16, 3/8, 7/16, 1/2, 9/16, and 5/8 Inch.
- ▶ Accessories: 1/2 Inch Drive Drag Link, Heavy-Duty Ratchet, Ratchet Adapter, Long Handle Ratchet, 2-1/2, 5, and 10 Inch Extensions, 18-5/8 Inch Hinge Handle, Universal Joint, 18 Inch Speed Handle, and Sliding T-Handle.
- ▶ Weight (lbs): 27.52



| Contents | Description | ASME Spec. | AS Spec. |
|----------|-------------------------------|-------------|---------------|
| J5412 | Socket, 1/2" DR 3/8" 12 PT | ASME B107.1 | AS954E S3.8.1 |
| J5414 | Socket, 1/2" DR 7/16" 12 PT | ASME B107.1 | AS954E S3.8.1 |
| J5416 | Socket, 1/2" DR 1/2" 12 PT | ASME B107.1 | AS954E S3.8.1 |
| J5418 | Socket, 1/2" DR 9/16" 12 PT | ASME B107.1 | AS954E S3.8.1 |
| J5419 | Socket, 1/2" DR 19/32" 12 PT | ASME B107.1 | AS954E S3.8.1 |
| J5420 | Socket, 1/2" DR 5/8" 12 PT | ASME B107.1 | AS954E S3.8.1 |
| J5422 | Socket, 1/2" DR 11/16" 12 PT | ASME B107.1 | AS954E S3.8.1 |
| J5424 | Socket, 1/2" DR 3/4" 12 PT | ASME B107.1 | AS954E S3.8.1 |
| J5425 | Socket, 1/2" DR 25/32" 12 PT | ASME B107.1 | AS954E S3.8.1 |
| J5426 | Socket, 1/2" DR 13/16" 12 PT | ASME B107.1 | AS954E S3.8.1 |
| J5428 | Socket, 1/2" DR 7/8" 12 PT | ASME B107.1 | AS954E S3.8.1 |
| J5429 | Socket, 1/2" DR 29/32" 12 PT | ASME B107.1 | AS954E S3.8.1 |
| J5430 | Socket, 1/2" DR 15/16" 12 PT | ASME B107.1 | AS954E S3.8.1 |
| J5432 | Socket, 1/2" DR 1" 12 PT | ASME B107.1 | AS954E S3.8.1 |
| J5434 | Socket, 1/2" DR 1-1/16" 12 PT | ASME B107.1 | AS954E S3.8.1 |
| J5436 | Socket, 1/2" DR 1-1/8" 12 PT | ASME B107.1 | AS954E S3.8.1 |

(CONTINUED ON NEXT PAGE)





1/2" DRIVE 65 PIECE COMBINATION SOCKET SET - 8 AND 12 POINT (CONTINUED)

| Contents | Description | ASME Spec. | AS Spec. |
|-----------------|--|-------------------|-----------------|
| J5438 | Socket, 1/2" DR 1-3/16" 12 PT | ASME B107.1 | AS954E S3.8.1 |
| J5440 | Socket, 1/2" DR 1-1/4" 12 PT | ASME B107.1 | AS954E S3.8.1 |
| J5442 | Socket, 1/2" DR 1-5/16" 12 PT | ASME B107.1 | AS954E S3.8.1 |
| J5444 | Socket, 1/2" DR 1-3/8" 12 PT | ASME B107.1 | AS954E S3.8.1 |
| J5446 | Socket, 1/2" DR 1-7/16" 12 PT | ASME B107.1 | AS954E S3.8.1 |
| J5448 | Socket, 1/2" DR 1-1/2" 12 PT | ASME B107.1 | AS954E S3.8.1 |
| J5316 | Socket, 1/2" DR 1/2" 12 PT Deep | ASME B107.1 | AS954E S3.8.1 |
| J5318 | Socket, 1/2" DR 9/16" 12 PT Deep | ASME B107.1 | AS954E S3.8.1 |
| J5320 | Socket, 1/2" DR 5/8" 12 PT Deep | ASME B107.1 | AS954E S3.8.1 |
| J5322 | Socket, 1/2" DR 11/16" 12 PT Deep | ASME B107.1 | AS954E S3.8.1 |
| J5324 | Socket, 1/2" DR 3/4" 12 PT Deep | ASME B107.1 | AS954E S3.8.1 |
| J5326 | Socket, 1/2" DR 13/16" 12 PT Deep | ASME B107.1 | AS954E S3.8.1 |
| J5328 | Socket, 1/2" DR 7/8" 12 PT Deep | ASME B107.1 | AS954E S3.8.1 |
| J5330 | Socket, 1/2" DR 15/16" 12 PT Deep | ASME B107.1 | AS954E S3.8.1 |
| J5332 | Socket, 1/2" DR 1" 12 PT Deep | ASME B107.1 | AS954E S3.8.1 |
| J5334 | Socket, 1/2" DR 1-1/16" 12 PT Deep | ASME B107.1 | AS954E S3.8.1 |
| J5336 | Socket, 1/2" DR 1-1/8" 12 PT Deep | ASME B107.1 | AS954E S3.8.1 |
| J5340 | Socket, 1/2" DR 1-1/4" 12 PT Deep | ASME B107.1 | AS954E S3.8.1 |
| J5475 | Socket, Universal 1/2" DR 1/2" 12 PT | ASME B107.1 | AS954E S3.8.1 |
| J5476 | Socket, Universal 1/2" DR 9/16" 12 PT | ASME B107.1 | AS954E S3.8.1 |
| J5477 | Socket, Universal 1/2" DR 5/8" 12 PT | ASME B107.1 | AS954E S3.8.1 |
| J5412S | Socket, 1/2" DR 3/8" 8 PT | ASME B107.1 | |
| J5414S | Socket, 1/2" DR 7/16" 8 PT | ASME B107.1 | |
| J5416S | Socket, 1/2" DR 1/2" 8 PT | ASME B107.1 | |
| J5418S | Socket, 1/2" DR 9/16" 8 PT | ASME B107.1 | |
| J5420S | Socket, 1/2" DR 5/8" 8 PT | ASME B107.1 | |
| J5422S | Socket, 1/2" DR 11/16" 8 PT | ASME B107.1 | |
| J5424S | Socket, 1/2" DR 3/4" 8 PT | ASME B107.1 | |
| J5426S | Socket, 1/2" DR 13/16" 8 PT | ASME B107.1 | |
| J5428S | Socket, 1/2" DR 7/8" 8 PT | ASME B107.1 | |
| J5432S | Socket, 1/2" DR 1" 8 PT | ASME B107.1 | |
| J54411/4 | Socket, Hex Bit 1/2" DR 1/4" | | |
| J54415/16 | Socket, Hex Bit 1/2" DR 5/16" | | |
| J54413/8 | Socket, Hex Bit 1/2" DR 3/8" | | |
| J54417/16 | Socket, Hex Bit 1/2" DR 7/16" | | |
| J54411/2 | Socket, Hex Bit 1/2" DR 1/2" | | |
| J54419/16 | Socket, Hex Bit 1/2" DR 9/16" | | |
| J54415/8 | Socket, Hex Bit 1/2" DR 5/8" | | |
| J5444A | Socket, 1/2" DR Drag Link 3/4" | | |
| J5447 | Ratchet, Adapter 1/2" DR 2-21/32" | ASME B107.500 | |
| J5449 | Ratchet, 1/2" DR Standard Length Classic Pear Head 10" | ASME B107.500 | |
| J5450 | Ratchet, 1/2" DR Long Classic Pear Head 16" | ASME B107.500 | |
| J5460 | Extension, 1/2" DR 2-1/2" | ASME B107.500 | AS 4283 |
| J5461 | Extension, 1/2" DR 5" | ASME B107.500 | AS 4283 |
| J5463 | Extension, 1/2" DR 10" | ASME B107.500 | AS 4283 |
| J5468 | Handle, Hinge 1/2" DR 18-5/8" | ASME B107.500 | AS 4283 |
| J5470A | Socket, 1/2" DR Universal Joint | ASME B107.500 | |
| J5480G | Handle, Speed 1/2" DR 18" | ASME B107.500 | |
| J5485 | Handle, Sliding T 1/2" DR 12-15/16" | ASME B107.500 | |



1/2" DRIVE 54 PIECE METRIC SOCKET SET WITH TOOL BOX - 12 POINT

METRIC

Product #: J54216



- ▶ 12 Point Standard: 10, 11, 12, 13, 14, 15, 16, 17, 18, 19, 20, 21, 22, 23, 24, 25, 26, 27, 28, 29, 30, 32, 36 mm.
- ▶ 12 Point Deep: 10, 11, 12, 13, 14, 15, 16, 17, 18, 19, 20, 21, 22, 24, 25, 26 mm.
- ▶ Bit Sockets: Hex 6, 8, 10, 12, 14, 17 mm.
- ▶ Accessories: Standard and Long Handle Ratchets, 2-1/2, 5, and 10 Inch Extensions, 18-5/8 Inch Hinge Handle, Universal Joint, 18 Inch Speed Handle, Sliding T-Handle.
- ▶ 4-Drawer Drop-Front Top Chest.
- ▶ Weight (lbs): 76.88



| Contents | Description | ASME Spec. | AS Spec. |
|----------|-----------------------------|--------------|---------------|
| J5410M | Socket, 1/2" DR 10 mm 12 PT | ASME B107.5M | AS954E S3.8.1 |
| J5411M | Socket, 1/2" DR 11 mm 12 PT | ASME B107.5M | AS954E S3.8.1 |
| J5412M | Socket, 1/2" DR 12 mm 12 PT | ASME B107.5M | AS954E S3.8.1 |
| J5413M | Socket, 1/2" DR 13 mm 12 PT | ASME B107.5M | AS954E S3.8.1 |
| J5414M | Socket, 1/2" DR 14 mm 12 PT | ASME B107.5M | AS954E S3.8.1 |
| J5415M | Socket, 1/2" DR 15 mm 12 PT | ASME B107.5M | AS954E S3.8.1 |
| J5416M | Socket, 1/2" DR 16 mm 12 PT | ASME B107.5M | AS954E S3.8.1 |
| J5417M | Socket, 1/2" DR 17 mm 12 PT | ASME B107.5M | AS954E S3.8.1 |
| J5418M | Socket, 1/2" DR 18 mm 12 PT | ASME B107.5M | AS954E S3.8.1 |
| J5419M | Socket, 1/2" DR 19 mm 12 PT | ASME B107.5M | AS954E S3.8.1 |
| J5420M | Socket, 1/2" DR 20 mm 12 PT | ASME B107.5M | AS954E S3.8.1 |
| J5421M | Socket, 1/2" DR 21 mm 12 PT | ASME B107.5M | AS954E S3.8.1 |

(CONTINUED ON NEXT PAGE)





**1/2" DRIVE 54 PIECE METRIC SOCKET SET
WITH TOOL BOX - 12 POINT (CONTINUED)**

| Contents | Description | ASME Spec. | AS Spec. |
|-----------------|--|-------------------|-----------------|
| J5422M | Socket, 1/2" DR 22 mm 12 PT | ASME B107.5M | AS954E S3.8.1 |
| J5423M | Socket, 1/2" DR 23 mm 12 PT | ASME B107.5M | AS954E S3.8.1 |
| J5424M | Socket, 1/2" DR 24 mm 12 PT | ASME B107.5M | AS954E S3.8.1 |
| J5425M | Socket, 1/2" DR 25 mm 12 PT | ASME B107.5M | AS954E S3.8.1 |
| J5426M | Socket, 1/2" DR 26 mm 12 PT | ASME B107.5M | AS954E S3.8.1 |
| J5427M | Socket, 1/2" DR 27 mm 12 PT | ASME B107.5M | AS954E S3.8.1 |
| J5428M | Socket, 1/2" DR 28 mm 12 PT | ASME B107.5M | AS954E S3.8.1 |
| J5429M | Socket, 1/2" DR 29 mm 12 PT | ASME B107.5M | AS954E S3.8.1 |
| J5430M | Socket, 1/2" DR 30 mm 12 PT | ASME B107.5M | AS954E S3.8.1 |
| J5432M | Socket, 1/2" DR 32 mm 12 PT | ASME B107.5M | AS954E S3.8.1 |
| J5436M | Socket, 1/2" DR 36 mm 12 PT | ASME B107.5M | AS954E S3.8.1 |
| J5310M | Socket, 1/2" DR 10 mm 12 PT Deep | ASME B107.5M | AS954E S3.8.1 |
| J5311M | Socket, 1/2" DR 11 mm 12 PT Deep | ASME B107.5M | AS954E S3.8.1 |
| J5312M | Socket, 1/2" DR 12 mm 12 PT Deep | ASME B107.5M | AS954E S3.8.1 |
| J5313M | Socket, 1/2" DR 13 mm 12 PT Deep | ASME B107.5M | AS954E S3.8.1 |
| J5314M | Socket, 1/2" DR 14 mm 12 PT Deep | ASME B107.5M | AS954E S3.8.1 |
| J5315M | Socket, 1/2" DR 15 mm 12 PT Deep | ASME B107.5M | AS954E S3.8.1 |
| J5316M | Socket, 1/2" DR 16 mm 12 PT Deep | ASME B107.5M | AS954E S3.8.1 |
| J5317M | Socket, 1/2" DR 17 mm 12 PT Deep | ASME B107.5M | AS954E S3.8.1 |
| J5318M | Socket, 1/2" DR 18 mm 12 PT Deep | ASME B107.5M | AS954E S3.8.1 |
| J5319M | Socket, 1/2" DR 19 mm 12 PT Deep | ASME B107.5M | AS954E S3.8.1 |
| J5320M | Socket, 1/2" DR 20 mm 12 PT Deep | ASME B107.5M | AS954E S3.8.1 |
| J5321M | Socket, 1/2" DR 21 mm 12 PT Deep | ASME B107.5M | AS954E S3.8.1 |
| J5322M | Socket, 1/2" DR 22 mm 12 PT Deep | ASME B107.5M | AS954E S3.8.1 |
| J5324M | Socket, 1/2" DR 24 mm 12 PT Deep | ASME B107.5M | AS954E S3.8.1 |
| J5325M | Socket, 1/2" DR 25 mm 12 PT Deep | ASME B107.5M | AS954E S3.8.1 |
| J5326M | Socket, 1/2" DR 26 mm 12 PT Deep | ASME B107.5M | AS954E S3.8.1 |
| J5441-6M | Socket, Hex Bit 1/2" DR 6 mm | | |
| J5441-8M | Socket, Hex Bit 1/2" DR 8 mm | | |
| J5441-10M | Socket, Hex Bit 1/2" DR 10 mm | | |
| J5441-12M | Socket, Hex Bit 1/2" DR 12 mm | | |
| J5441-14M | Socket, Hex Bit 1/2" DR 14 mm | | |
| J5441-17M | Socket, Hex Bit 3/8" DR 17 mm | | |
| J5449 | Ratchet, 1/2" DR Standard Length Classic Pear Head 10" | ASME B107.500 | |
| J5450 | Ratchet, 1/2" DR Long Classic Pear Head 16" | ASME B107.500 | |
| J5460 | Extension, 1/2" DR 2-1/2" | ASME B107.500 | AS 4283 |
| J5461 | Extension, 1/2" DR 5" | ASME B107.500 | AS 4283 |
| J5463 | Extension, 1/2" DR 10" | ASME B107.500 | AS 4283 |
| J5468 | Handle, Hinge 1/2" DR 18-5/8" | ASME B107.500 | AS 4283 |
| J5470A | Socket, 1/2" DR Universal Joint | ASME B107.500 | |
| J5480G | Handle, Speed 1/2" DR 18" | ASME B107.500 | |
| J5485 | Handle, Sliding T 1/2" DR 12-15/16" | ASME B107.500 | |
| J442715-4RD-D | 27" Chest with Drop Front Red | | |



1/2" DRIVE 54 PIECE METRIC SOCKET SET - 12 POINT

METRIC



Product #: J54218

- ▶ 12 Point Standard: 10, 11, 12, 13, 14, 15, 16, 17, 18, 19, 20, 21, 22, 23, 24, 25, 26, 27, 28, 29, 30, 32, 36 mm
- ▶ 12 Point Deep: 10, 11, 12, 13, 14, 15, 16, 17, 18, 19, 20, 21, 22, 24, 25, 26 mm.
- ▶ Hex Bits: 6, 8, 10, 12, 14, 17 mm.
- ▶ Accessories: Standard and Long Handle Ratchets, 2-1/2, 5, and 10 Inch Extensions, 18-5/8 Inch Hinge Handle, Universal Joint, 18 Inch Speed Handle, and Sliding T-Handle.
- ▶ Weight (lbs): 25.75



| Contents | Description | ASME Spec. | AS Spec. |
|----------|-----------------------------|--------------|---------------|
| J5410M | Socket, 1/2" DR 10 mm 12 PT | ASME B107.5M | AS954E S3.8.1 |
| J5411M | Socket, 1/2" DR 11 mm 12 PT | ASME B107.5M | AS954E S3.8.1 |
| J5412M | Socket, 1/2" DR 12 mm 12 PT | ASME B107.5M | AS954E S3.8.1 |
| J5413M | Socket, 1/2" DR 13 mm 12 PT | ASME B107.5M | AS954E S3.8.1 |
| J5414M | Socket, 1/2" DR 14 mm 12 PT | ASME B107.5M | AS954E S3.8.1 |
| J5415M | Socket, 1/2" DR 15 mm 12 PT | ASME B107.5M | AS954E S3.8.1 |
| J5416M | Socket, 1/2" DR 16 mm 12 PT | ASME B107.5M | AS954E S3.8.1 |
| J5417M | Socket, 1/2" DR 17 mm 12 PT | ASME B107.5M | AS954E S3.8.1 |
| J5418M | Socket, 1/2" DR 18 mm 12 PT | ASME B107.5M | AS954E S3.8.1 |
| J5419M | Socket, 1/2" DR 19 mm 12 PT | ASME B107.5M | AS954E S3.8.1 |

(CONTINUED ON NEXT PAGE)





1/2" DRIVE 54 PIECE METRIC SOCKET SET - 12 POINT (CONTINUED)

| Contents | Description | ASME Spec. | AS Spec. |
|-----------|--|---------------|---------------|
| J5420M | Socket, 1/2" DR 20 mm 12 PT | ASME B107.5M | AS954E S3.8.1 |
| J5421M | Socket, 1/2" DR 21 mm 12 PT | ASME B107.5M | AS954E S3.8.1 |
| J5422M | Socket, 1/2" DR 22 mm 12 PT | ASME B107.5M | AS954E S3.8.1 |
| J5423M | Socket, 1/2" DR 23 mm 12 PT | ASME B107.5M | AS954E S3.8.1 |
| J5424M | Socket, 1/2" DR 24 mm 12 PT | ASME B107.5M | AS954E S3.8.1 |
| J5425M | Socket, 1/2" DR 25 mm 12 PT | ASME B107.5M | AS954E S3.8.1 |
| J5426M | Socket, 1/2" DR 26 mm 12 PT | ASME B107.5M | AS954E S3.8.1 |
| J5427M | Socket, 1/2" DR 27 mm 12 PT | ASME B107.5M | AS954E S3.8.1 |
| J5428M | Socket, 1/2" DR 28 mm 12 PT | ASME B107.5M | AS954E S3.8.1 |
| J5429M | Socket, 1/2" DR 29 mm 12 PT | ASME B107.5M | AS954E S3.8.1 |
| J5430M | Socket, 1/2" DR 30 mm 12 PT | ASME B107.5M | AS954E S3.8.1 |
| J5432M | Socket, 1/2" DR 32 mm 12 PT | ASME B107.5M | AS954E S3.8.1 |
| J5436M | Socket, 1/2" DR 36 mm 12 PT | ASME B107.5M | AS954E S3.8.1 |
| J5310M | Socket, 1/2" DR 10 mm 12 PT Deep | ASME B107.5M | AS954E S3.8.1 |
| J5311M | Socket, 1/2" DR 11 mm 12 PT Deep | ASME B107.5M | AS954E S3.8.1 |
| J5312M | Socket, 1/2" DR 12 mm 12 PT Deep | ASME B107.5M | AS954E S3.8.1 |
| J5313M | Socket, 1/2" DR 13 mm 12 PT Deep | ASME B107.5M | AS954E S3.8.1 |
| J5314M | Socket, 1/2" DR 14 mm 12 PT Deep | ASME B107.5M | AS954E S3.8.1 |
| J5315M | Socket, 1/2" DR 15 mm 12 PT Deep | ASME B107.5M | AS954E S3.8.1 |
| J5316M | Socket, 1/2" DR 16 mm 12 PT Deep | ASME B107.5M | AS954E S3.8.1 |
| J5317M | Socket, 1/2" DR 17 mm 12 PT Deep | ASME B107.5M | AS954E S3.8.1 |
| J5318M | Socket, 1/2" DR 18 mm 12 PT Deep | ASME B107.5M | AS954E S3.8.1 |
| J5319M | Socket, 1/2" DR 19 mm 12 PT Deep | ASME B107.5M | AS954E S3.8.1 |
| J5320M | Socket, 1/2" DR 20 mm 12 PT Deep | ASME B107.5M | AS954E S3.8.1 |
| J5321M | Socket, 1/2" DR 21 mm 12 PT Deep | ASME B107.5M | AS954E S3.8.1 |
| J5322M | Socket, 1/2" DR 22 mm 12 PT Deep | ASME B107.5M | AS954E S3.8.1 |
| J5324M | Socket, 1/2" DR 24 mm 12 PT Deep | ASME B107.5M | AS954E S3.8.1 |
| J5325M | Socket, 1/2" DR 25 mm 12 PT Deep | ASME B107.5M | AS954E S3.8.1 |
| J5326M | Socket, 1/2" DR 26 mm 12 PT Deep | ASME B107.5M | AS954E S3.8.1 |
| J5441-6M | Socket, Hex Bit 1/2" DR 6 mm | | |
| J5441-8M | Socket, Hex Bit 1/2" DR 8 mm | | |
| J5441-10M | Socket, Hex Bit 1/2" DR 10 mm | | |
| J5441-12M | Socket, Hex Bit 1/2" DR 12 mm | | |
| J5441-14M | Socket, Hex Bit 1/2" DR 14 mm | | |
| J5441-17M | Socket, Hex Bit 3/8" DR 17 mm | | |
| J5449 | Ratchet, 1/2" DR Standard Length Classic Pear Head 10" | ASME B107.500 | |
| J5450 | Ratchet, 1/2" DR Long Classic Pear Head 16" | ASME B107.500 | |
| J5460 | Extension, 1/2" DR 2-1/2" | ASME B107.500 | AS 4283 |
| J5461 | Extension, 1/2" DR 5" | ASME B107.500 | AS 4283 |
| J5463 | Extension, 1/2" DR 10" | ASME B107.500 | AS 4283 |
| J5468 | Handle, HInge 1/2" DR 18-5/8" | ASME B107.500 | AS 4283 |
| J5470A | Socket, 1/2" DR Universal Joint | ASME B107.500 | |
| J5480G | Handle, Speed 1/2" DR 18" | ASME B107.500 | |
| J5485 | Handle, Sliding T 1/2" DR 12-15/16" | ASME B107.500 | |



1/2" DRIVE 31 PIECE METRIC SOCKET SET - 12 POINT

METRIC

Product #: J54214

- ▶ 12 Point Standard: 10, 11, 12, 13, 14, 15, 16, 17, 18, 19, 20, 21, 22, 23, 24, 25, 26 mm.
- ▶ 12 Point Deep: 16, 17, 18, 19, 20, 21, 22, 24, 25, 26 mm.
- ▶ Accessories: Pear Head Ratchet, 5 and 10 Inch Extensions, 15-3/4 Inch Hinge Handle, and Blow-Molded Case.
- ▶ Weight (lbs): 18.41



| Contents | Description | ASME Spec. | AS Spec. |
|----------|--|---------------|---------------|
| J5410M | Socket, 1/2" DR 10 mm 12 PT | ASME B107.5M | AS954E S3.8.1 |
| J5411M | Socket, 1/2" DR 11 mm 12 PT | ASME B107.5M | AS954E S3.8.1 |
| J5412M | Socket, 1/2" DR 12 mm 12 PT | ASME B107.5M | AS954E S3.8.1 |
| J5413M | Socket, 1/2" DR 13 mm 12 PT | ASME B107.5M | AS954E S3.8.1 |
| J5414M | Socket, 1/2" DR 14 mm 12 PT | ASME B107.5M | AS954E S3.8.1 |
| J5415M | Socket, 1/2" DR 15 mm 12 PT | ASME B107.5M | AS954E S3.8.1 |
| J5416M | Socket, 1/2" DR 16 mm 12 PT | ASME B107.5M | AS954E S3.8.1 |
| J5417M | Socket, 1/2" DR 17 mm 12 PT | ASME B107.5M | AS954E S3.8.1 |
| J5418M | Socket, 1/2" DR 18 mm 12 PT | ASME B107.5M | AS954E S3.8.1 |
| J5419M | Socket, 1/2" DR 19 mm 12 PT | ASME B107.5M | AS954E S3.8.1 |
| J5420M | Socket, 1/2" DR 20 mm 12 PT | ASME B107.5M | AS954E S3.8.1 |
| J5421M | Socket, 1/2" DR 21 mm 12 PT | ASME B107.5M | AS954E S3.8.1 |
| J5422M | Socket, 1/2" DR 22 mm 12 PT | ASME B107.5M | AS954E S3.8.1 |
| J5423M | Socket, 1/2" DR 23 mm 12 PT | ASME B107.5M | AS954E S3.8.1 |
| J5424M | Socket, 1/2" DR 24 mm 12 PT | ASME B107.5M | AS954E S3.8.1 |
| J5425M | Socket, 1/2" DR 25 mm 12 PT | ASME B107.5M | AS954E S3.8.1 |
| J5426M | Socket, 1/2" DR 26 mm 12 PT | ASME B107.5M | AS954E S3.8.1 |
| J5316M | Socket, 1/2" DR 16 mm 12 PT Deep | ASME B107.5M | AS954E S3.8.1 |
| J5317M | Socket, 1/2" DR 17 mm 12 PT Deep | ASME B107.5M | AS954E S3.8.1 |
| J5318M | Socket, 1/2" DR 18 mm 12 PT Deep | ASME B107.5M | AS954E S3.8.1 |
| J5319M | Socket, 1/2" DR 19 mm 12 PT Deep | ASME B107.5M | AS954E S3.8.1 |
| J5320M | Socket, 1/2" DR 20 mm 12 PT Deep | ASME B107.5M | AS954E S3.8.1 |
| J5321M | Socket, 1/2" DR 21 mm 12 PT Deep | ASME B107.5M | AS954E S3.8.1 |
| J5322M | Socket, 1/2" DR 22 mm 12 PT Deep | ASME B107.5M | AS954E S3.8.1 |
| J5324M | Socket, 1/2" DR 24 mm 12 PT Deep | ASME B107.5M | AS954E S3.8.1 |
| J5325M | Socket, 1/2" DR 25 mm 12 PT Deep | ASME B107.5M | AS954E S3.8.1 |
| J5326M | Socket, 1/2" DR 26 mm 12 PT Deep | ASME B107.5M | AS954E S3.8.1 |
| J5449 | Ratchet, 1/2" DR Standard Length Classic Pear Head 10" | ASME B107.500 | |
| J5461 | Extension, 1/2" DR 5" | ASME B107.500 | AS 4283 |
| J5463 | Extension, 1/2" DR 10" | ASME B107.500 | AS 4283 |
| J5467 | Handle, Hinge 1/2" DR 15-3/4" | ASME B107.500 | AS 4283 |
| JBM1207 | Blow-Molded Case | | |



1/2" DRIVE 31 PIECE METRIC SOCKET SET - 12 POINT

METRIC

Product #: J54214XL



- › 12 Point Standard: 10, 11, 12, 13, 14, 15, 16, 17, 18, 19, 20, 21, 22, 23, 24, 25, 26 mm.
- › 12 Point Deep: 16, 17, 18, 19, 20, 21, 22, 23, 24, 25, 26 mm.
- › Accessories: Premium Ratchet, 5 and 10 Inch Extensions, Hinge Handle, and Blow-Molded Case.
- › Weight (lbs): 18.48



| Contents | Description | ASME Spec. | AS Spec. |
|----------|--|---------------|---------------|
| J5316M | Socket, 1/2" DR 16 mm 12 PT Deep | ASME B107.5M | AS954E S3.8.1 |
| J5317M | Socket, 1/2" DR 17 mm 12 PT Deep | ASME B107.5M | AS954E S3.8.1 |
| J5318M | Socket, 1/2" DR 18 mm 12 PT Deep | ASME B107.5M | AS954E S3.8.1 |
| J5319M | Socket, 1/2" DR 19 mm 12 PT Deep | ASME B107.5M | AS954E S3.8.1 |
| J5320M | Socket, 1/2" DR 20 mm 12 PT Deep | ASME B107.5M | AS954E S3.8.1 |
| J5321M | Socket, 1/2" DR 21 mm 12 PT Deep | ASME B107.5M | AS954E S3.8.1 |
| J5322M | Socket, 1/2" DR 22 mm 12 PT Deep | ASME B107.5M | AS954E S3.8.1 |
| J5324M | Socket, 1/2" DR 24 mm 12 PT Deep | ASME B107.5M | AS954E S3.8.1 |
| J5325M | Socket, 1/2" DR 25 mm 12 PT Deep | ASME B107.5M | AS954E S3.8.1 |
| J5326M | Socket, 1/2" DR 26 mm 12 PT Deep | ASME B107.5M | AS954E S3.8.1 |
| J5410M | Socket, 1/2" DR 10 mm 12 PT | ASME B107.5M | AS954E S3.8.1 |
| J5411M | Socket, 1/2" DR 11 mm 12 PT | ASME B107.5M | AS954E S3.8.1 |
| J5412M | Socket, 1/2" DR 12 mm 12 PT | ASME B107.5M | AS954E S3.8.1 |
| J5413M | Socket, 1/2" DR 13 mm 12 PT | ASME B107.5M | AS954E S3.8.1 |
| J5414M | Socket, 1/2" DR 14 mm 12 PT | ASME B107.5M | AS954E S3.8.1 |
| J5415M | Socket, 1/2" DR 15 mm 12 PT | ASME B107.5M | AS954E S3.8.1 |
| J5416M | Socket, 1/2" DR 16 mm 12 PT | ASME B107.5M | AS954E S3.8.1 |
| J5417M | Socket, 1/2" DR 17 mm 12 PT | ASME B107.5M | AS954E S3.8.1 |
| J5418M | Socket, 1/2" DR 18 mm 12 PT | ASME B107.5M | AS954E S3.8.1 |
| J5419M | Socket, 1/2" DR 19 mm 12 PT | ASME B107.5M | AS954E S3.8.1 |
| J5420M | Socket, 1/2" DR 20 mm 12 PT | ASME B107.5M | AS954E S3.8.1 |
| J5421M | Socket, 1/2" DR 21 mm 12 PT | ASME B107.5M | AS954E S3.8.1 |
| J5422M | Socket, 1/2" DR 22 mm 12 PT | ASME B107.5M | AS954E S3.8.1 |
| J5423M | Socket, 1/2" DR 23 mm 12 PT | ASME B107.5M | AS954E S3.8.1 |
| J5424M | Socket, 1/2" DR 24 mm 12 PT | ASME B107.5M | AS954E S3.8.1 |
| J5425M | Socket, 1/2" DR 25 mm 12 PT | ASME B107.5M | AS954E S3.8.1 |
| J5426M | Socket, 1/2" DR 26 mm 12 PT | ASME B107.5M | AS954E S3.8.1 |
| J5449XL | Ratchet, 1/2" DR Standard Length Premium Pear Head 10-1/2" | ASME B107.500 | |
| J5461 | Extension, 1/2" DR 5" | ASME B107.500 | AS 4283 |
| J5463 | Extension, 1/2" DR 10" | ASME B107.500 | AS 4283 |
| J5467 | Handle, Hinge 1/2" DR 15-3/4" | ASME B107.500 | AS 4283 |
| JBM1207 | Blow-Molded Case | | |



1/2" DRIVE 30 PIECE SOCKET SET - 12 POINT

Product #: J54126

- ▶ 12 Point Standard: 3/8, 7/16, 1/2, 9/16, 5/8, 11/16, 3/4, 13/16, 7/8, 15/16, 1, 1-1/16, 1-1/8, 1-1/4 Inch.
- ▶ 12 Point Deep: 1/2, 9/16, 5/8, 11/16, 3/4, 13/16, 7/8, 15/16, 1, 1-1/16, 1-1/8, 1-1/4 Inch.
- ▶ Accessories: Pear Head Ratchet, 5 and 10 Inch Extensions, 15-3/4 Inch Hinge Handle, and Blow-Molded Case.
- ▶ Weight (lbs): 19.90



| Contents | Description | ASME Spec. | AS Spec. |
|----------|--|---------------|---------------|
| J5412 | Socket, 1/2" DR 3/8" 12 PT | ASME B107.1 | AS954E S3.8.1 |
| J5414 | Socket, 1/2" DR 7/16" 12 PT | ASME B107.1 | AS954E S3.8.1 |
| J5416 | Socket, 1/2" DR 1/2" 12 PT | ASME B107.1 | AS954E S3.8.1 |
| J5418 | Socket, 1/2" DR 9/16" 12 PT | ASME B107.1 | AS954E S3.8.1 |
| J5420 | Socket, 1/2" DR 5/8" 12 PT | ASME B107.1 | AS954E S3.8.1 |
| J5422 | Socket, 1/2" DR 11/16" 12 PT | ASME B107.1 | AS954E S3.8.1 |
| J5424 | Socket, 1/2" DR 3/4" 12 PT | ASME B107.1 | AS954E S3.8.1 |
| J5426 | Socket, 1/2" DR 13/16" 12 PT | ASME B107.1 | AS954E S3.8.1 |
| J5428 | Socket, 1/2" DR 7/8" 12 PT | ASME B107.1 | AS954E S3.8.1 |
| J5430 | Socket, 1/2" DR 15/16" 12 PT | ASME B107.1 | AS954E S3.8.1 |
| J5432 | Socket, 1/2" DR 1" 12 PT | ASME B107.1 | AS954E S3.8.1 |
| J5434 | Socket, 1/2" DR 1-1/16" 12 PT | ASME B107.1 | AS954E S3.8.1 |
| J5436 | Socket, 1/2" DR 1-1/8" 12 PT | ASME B107.1 | AS954E S3.8.1 |
| J5440 | Socket, 1/2" DR 1-1/4" 12 PT | ASME B107.1 | AS954E S3.8.1 |
| J5316 | Socket, 1/2" DR 1/2" 12 PT Deep | ASME B107.1 | AS954E S3.8.1 |
| J5318 | Socket, 1/2" DR 9/16" 12 PT Deep | ASME B107.1 | AS954E S3.8.1 |
| J5320 | Socket, 1/2" DR 5/8" 12 PT Deep | ASME B107.1 | AS954E S3.8.1 |
| J5322 | Socket, 1/2" DR 11/16" 12 PT Deep | ASME B107.1 | AS954E S3.8.1 |
| J5324 | Socket, 1/2" DR 3/4" 12 PT Deep | ASME B107.1 | AS954E S3.8.1 |
| J5326 | Socket, 1/2" DR 13/16" 12 PT Deep | ASME B107.1 | AS954E S3.8.1 |
| J5328 | Socket, 1/2" DR 7/8" 12 PT Deep | ASME B107.1 | AS954E S3.8.1 |
| J5330 | Socket, 1/2" DR 15/16" 12 PT Deep | ASME B107.1 | AS954E S3.8.1 |
| J5332 | Socket, 1/2" DR 1" 12 PT Deep | ASME B107.1 | AS954E S3.8.1 |
| J5334 | Socket, 1/2" DR 1-1/16" 12 PT Deep | ASME B107.1 | AS954E S3.8.1 |
| J5336 | Socket, 1/2" DR 1-1/8" 12 PT Deep | ASME B107.1 | AS954E S3.8.1 |
| J5340 | Socket, 1/2" DR 1-1/4" 12 PT Deep | ASME B107.1 | AS954E S3.8.1 |
| J5449 | Ratchet, 1/2" DR Standard Length Classic Pear Head 10" | ASME B107.500 | |
| J5461 | Extension, 1/2" DR 5" | ASME B107.500 | AS 4283 |
| J5463 | Extension, 1/2" DR 10" | ASME B107.500 | AS 4283 |
| J5467 | Handle, Hinge 1/2" DR 15-3/4" | ASME B107.500 | AS 4283 |
| JBM1206 | Blow-Molded Case | | |





1/2" DRIVE 30 PIECE SOCKET SET - 12 POINT

Product #: **J54126XL**



- ▶ 12 Point Standard: 3/8, 7/16, 1/2, 9/16, 5/8, 11/16, 3/4, 13/16, 7/8, 15/16, 1, 1-1/16, 1-1/8, 1-3/16, 1-1/4 Inch.
- ▶ 12 Point Deep: 1/2, 9/16, 5/8, 11/16, 3/4, 13/16, 7/8, 15/16, 1, 1-1/16, 1-1/8, 1-3/16, 1-1/4 Inch.
- ▶ Accessories: Premium Ratchet, 5 and 10 Inch Extensions, Hinge Handle, and Blow-Molded Case.
- ▶ Weight (lbs): 20.28



| Contents | Description | ASME Spec. | AS Spec. |
|----------|--|---------------|---------------|
| J5316 | Socket, 1/2" DR 1/2" 12 PT Deep | ASME B107.1 | AS954E S3.8.1 |
| J5318 | Socket, 1/2" DR 9/16" 12 PT Deep | ASME B107.1 | AS954E S3.8.1 |
| J5320 | Socket, 1/2" DR 5/8" 12 PT Deep | ASME B107.1 | AS954E S3.8.1 |
| J5322 | Socket, 1/2" DR 11/16" 12 PT Deep | ASME B107.1 | AS954E S3.8.1 |
| J5324 | Socket, 1/2" DR 3/4" 12 PT Deep | ASME B107.1 | AS954E S3.8.1 |
| J5326 | Socket, 1/2" DR 13/16" 12 PT Deep | ASME B107.1 | AS954E S3.8.1 |
| J5328 | Socket, 1/2" DR 7/8" 12 PT Deep | ASME B107.1 | AS954E S3.8.1 |
| J5330 | Socket, 1/2" DR 15/16" 12 PT Deep | ASME B107.1 | AS954E S3.8.1 |
| J5332 | Socket, 1/2" DR 1" 12 PT Deep | ASME B107.1 | AS954E S3.8.1 |
| J5334 | Socket, 1/2" DR 1-1/16" 12 PT Deep | ASME B107.1 | AS954E S3.8.1 |
| J5336 | Socket, 1/2" DR 1-1/8" 12 PT Deep | ASME B107.1 | AS954E S3.8.1 |
| J5340 | Socket, 1/2" DR 1-1/4" 12 PT Deep | ASME B107.1 | AS954E S3.8.1 |
| J5412 | Socket, 1/2" DR 3/8" 12 PT | ASME B107.1 | AS954E S3.8.1 |
| J5414 | Socket, 1/2" DR 7/16" 12 PT | ASME B107.1 | AS954E S3.8.1 |
| J5416 | Socket, 1/2" DR 1/2" 12 PT | ASME B107.1 | AS954E S3.8.1 |
| J5418 | Socket, 1/2" DR 9/16" 12 PT | ASME B107.1 | AS954E S3.8.1 |
| J5420 | Socket, 1/2" DR 5/8" 12 PT | ASME B107.1 | AS954E S3.8.1 |
| J5422 | Socket, 1/2" DR 11/16" 12 PT | ASME B107.1 | AS954E S3.8.1 |
| J5424 | Socket, 1/2" DR 3/4" 12 PT | ASME B107.1 | AS954E S3.8.1 |
| J5426 | Socket, 1/2" DR 13/16" 12 PT | ASME B107.1 | AS954E S3.8.1 |
| J5428 | Socket, 1/2" DR 7/8" 12 PT | ASME B107.1 | AS954E S3.8.1 |
| J5430 | Socket, 1/2" DR 15/16" 12 PT | ASME B107.1 | AS954E S3.8.1 |
| J5432 | Socket, 1/2" DR 1" 12 PT | ASME B107.1 | AS954E S3.8.1 |
| J5434 | Socket, 1/2" DR 1-1/16" 12 PT | ASME B107.1 | AS954E S3.8.1 |
| J5436 | Socket, 1/2" DR 1-1/8" 12 PT | ASME B107.1 | AS954E S3.8.1 |
| J5440 | Socket, 1/2" DR 1-1/4" 12 PT | ASME B107.1 | AS954E S3.8.1 |
| J5449XL | Ratchet, 1/2" DR Standard Length Premium Pear Head 10-1/2" | ASME B107.500 | |
| J5461 | Extension, 1/2" DR 5" | ASME B107.500 | AS 4283 |
| J5463 | Extension, 1/2" DR 10" | ASME B107.500 | AS 4283 |
| J5467 | Handle, Hinge 1/2" DR 15-3/4" | ASME B107.500 | AS 4283 |
| JBM1205 | Blow-Molded Case | | |



1/2" DRIVE 29 PIECE METRIC SOCKET SET - 12 POINT

METRIC



Product #: J54212

- ▶ 12 Point Standard: 10, 11, 12, 13, 14, 15, 16, 17, 18, 19, 20, 21, 22, 23, 24, 25, 26, 27, 28, 29, 30, 32, 36 mm.
- ▶ Accessories: Pear Head Ratchet, 2-1/2, 5, and 10 Inch Extensions, Hinge Handle, Universal Joint, and Blow-Molded Case.
- ▶ Weight (lbs): 17.50



| Contents | Description | ASME Spec. | AS Spec. |
|----------|--|---------------|---------------|
| J5410M | Socket, 1/2" DR 10 mm 12 PT | ASME B107.5M | AS954E S3.8.1 |
| J5411M | Socket, 1/2" DR 11 mm 12 PT | ASME B107.5M | AS954E S3.8.1 |
| J5412M | Socket, 1/2" DR 12 mm 12 PT | ASME B107.5M | AS954E S3.8.1 |
| J5413M | Socket, 1/2" DR 13 mm 12 PT | ASME B107.5M | AS954E S3.8.1 |
| J5414M | Socket, 1/2" DR 14 mm 12 PT | ASME B107.5M | AS954E S3.8.1 |
| J5415M | Socket, 1/2" DR 15 mm 12 PT | ASME B107.5M | AS954E S3.8.1 |
| J5416M | Socket, 1/2" DR 16 mm 12 PT | ASME B107.5M | AS954E S3.8.1 |
| J5417M | Socket, 1/2" DR 17 mm 12 PT | ASME B107.5M | AS954E S3.8.1 |
| J5418M | Socket, 1/2" DR 18 mm 12 PT | ASME B107.5M | AS954E S3.8.1 |
| J5419M | Socket, 1/2" DR 19 mm 12 PT | ASME B107.5M | AS954E S3.8.1 |
| J5420M | Socket, 1/2" DR 20 mm 12 PT | ASME B107.5M | AS954E S3.8.1 |
| J5421M | Socket, 1/2" DR 21 mm 12 PT | ASME B107.5M | AS954E S3.8.1 |
| J5422M | Socket, 1/2" DR 22 mm 12 PT | ASME B107.5M | AS954E S3.8.1 |
| J5423M | Socket, 1/2" DR 23 mm 12 PT | ASME B107.5M | AS954E S3.8.1 |
| J5424M | Socket, 1/2" DR 24 mm 12 PT | ASME B107.5M | AS954E S3.8.1 |
| J5425M | Socket, 1/2" DR 25 mm 12 PT | ASME B107.5M | AS954E S3.8.1 |
| J5426M | Socket, 1/2" DR 26 mm 12 PT | ASME B107.5M | AS954E S3.8.1 |
| J5427M | Socket, 1/2" DR 27 mm 12 PT | ASME B107.5M | AS954E S3.8.1 |
| J5428M | Socket, 1/2" DR 28 mm 12 PT | ASME B107.5M | AS954E S3.8.1 |
| J5429M | Socket, 1/2" DR 29 mm 12 PT | ASME B107.5M | AS954E S3.8.1 |
| J5430M | Socket, 1/2" DR 30 mm 12 PT | ASME B107.5M | AS954E S3.8.1 |
| J5432M | Socket, 1/2" DR 32 mm 12 PT | ASME B107.5M | AS954E S3.8.1 |
| J5436M | Socket, 1/2" DR 36 mm 12 PT | ASME B107.5M | AS954E S3.8.1 |
| J5449 | Ratchet, 1/2" DR Standard Length Classic Pear Head 10" | ASME B107.500 | |
| J5460 | Extension, 1/2" DR 2-1/2" | ASME B107.500 | AS 4283 |
| J5461 | Extension, 1/2" DR 5" | ASME B107.500 | AS 4283 |
| J5463 | Extension, 1/2" DR 10" | ASME B107.500 | AS 4283 |
| J5467 | Handle, Hinge 1/2" DR 15-3/4" | ASME B107.500 | AS 4283 |
| J5470A | Socket, 1/2" DR Universal Joint | ASME B107.500 | |
| JBM1206 | Blow-Molded Case | | |





1/2" DRIVE 29 PIECE METRIC SOCKET SET - 12 POINT



Product #: **J54212XL**

- › 12 Point Standard: 10, 11, 12, 13, 14, 15, 16, 17, 18, 19, 20, 21, 22, 23, 24, 25, 26, 27, 28, 29, 30, 32, 36 mm.
- › Accessories: Premium Ratchet, 2-1/2", 5, and 10 Inch Extensions, Universal Joint, Hinge Handle, and Blow-Molded Case.
- › Weight (lbs): 17.96



| Contents | Description | ASME Spec. | AS Spec. |
|----------|--|---------------|---------------|
| J5410M | Socket, 1/2" DR 10 mm 12 PT | ASME B107.5M | AS954E S3.8.1 |
| J5411M | Socket, 1/2" DR 11 mm 12 PT | ASME B107.5M | AS954E S3.8.1 |
| J5412M | Socket, 1/2" DR 12 mm 12 PT | ASME B107.5M | AS954E S3.8.1 |
| J5413M | Socket, 1/2" DR 13 mm 12 PT | ASME B107.5M | AS954E S3.8.1 |
| J5414M | Socket, 1/2" DR 14 mm 12 PT | ASME B107.5M | AS954E S3.8.1 |
| J5415M | Socket, 1/2" DR 15 mm 12 PT | ASME B107.5M | AS954E S3.8.1 |
| J5416M | Socket, 1/2" DR 16 mm 12 PT | ASME B107.5M | AS954E S3.8.1 |
| J5417M | Socket, 1/2" DR 17 mm 12 PT | ASME B107.5M | AS954E S3.8.1 |
| J5418M | Socket, 1/2" DR 18 mm 12 PT | ASME B107.5M | AS954E S3.8.1 |
| J5419M | Socket, 1/2" DR 19 mm 12 PT | ASME B107.5M | AS954E S3.8.1 |
| J5420M | Socket, 1/2" DR 20 mm 12 PT | ASME B107.5M | AS954E S3.8.1 |
| J5421M | Socket, 1/2" DR 21 mm 12 PT | ASME B107.5M | AS954E S3.8.1 |
| J5422M | Socket, 1/2" DR 22 mm 12 PT | ASME B107.5M | AS954E S3.8.1 |
| J5423M | Socket, 1/2" DR 23 mm 12 PT | ASME B107.5M | AS954E S3.8.1 |
| J5424M | Socket, 1/2" DR 24 mm 12 PT | ASME B107.5M | AS954E S3.8.1 |
| J5425M | Socket, 1/2" DR 25 mm 12 PT | ASME B107.5M | AS954E S3.8.1 |
| J5426M | Socket, 1/2" DR 26 mm 12 PT | ASME B107.5M | AS954E S3.8.1 |
| J5427M | Socket, 1/2" DR 27 mm 12 PT | ASME B107.5M | AS954E S3.8.1 |
| J5428M | Socket, 1/2" DR 28 mm 12 PT | ASME B107.5M | AS954E S3.8.1 |
| J5429M | Socket, 1/2" DR 29 mm 12 PT | ASME B107.5M | AS954E S3.8.1 |
| J5430M | Socket, 1/2" DR 30 mm 12 PT | ASME B107.5M | AS954E S3.8.1 |
| J5432M | Socket, 1/2" DR 32 mm 12 PT | ASME B107.5M | AS954E S3.8.1 |
| J5436M | Socket, 1/2" DR 36 mm 12 PT | ASME B107.5M | AS954E S3.8.1 |
| J5449XL | Ratchet, 1/2" DR Standard Length Premium Pear Head 10-1/2" | ASME B107.500 | |
| J5460 | Extension, 1/2" DR 2-1/2" | ASME B107.500 | AS 4283 |
| J5461 | Extension, 1/2" DR 5" | ASME B107.500 | AS 4283 |
| J5463 | Extension, 1/2" DR 10" | ASME B107.500 | AS 4283 |
| J5467 | Handle, Hinge 1/2" DR 15-3/4" | ASME B107.500 | AS 4283 |
| J5470A | Socket, 1/2" DR Universal Joint | ASME B107.500 | |
| JBM1206 | Blow-Molded Case | | |



1/2" DRIVE 27 PIECE TOOL SET - 12 POINT

Product #: J54128

- ▶ 12 Point Standard: 7/16, 1/2, 9/16, 5/8, 11/16, 3/4, 13/16, 7/8, 15/16, 1, 1-1/16, 1-1/8, 1-1/4, 5/8 Inch Spark Plug.
- ▶ Accessories: Combination Wrenches 3/8, 7/16, 1/2, 9/16, 5/8, 11/16, and 3/4 Inch. 9-1/2 Inch Tongue and Groove Pliers, Pear Head Ratchet, 5 and 10 Inch Extensions, 15-3/4 Inch Hinge Handle, Universal Joint, and Metal Box.
- ▶ Weight (lbs): 19.09



| Contents | Description | ASME Spec. | AS Spec. |
|----------|--|---------------|---------------|
| J1212ASD | Wrench, Combination 3/8" 12 PT | ASME B107.100 | AS 954 |
| J1214ASD | Wrench, Combination 7/16" 12 PT | ASME B107.100 | AS 954 |
| J1216ASD | Wrench, Combination 1/2" 12 PT | ASME B107.100 | AS 954 |
| J1218ASD | Wrench, Combination 9/16" 12 PT | ASME B107.100 | AS 954 |
| J1220ASD | Wrench, Combination 5/8" 12 PT | ASME B107.100 | AS 954 |
| J1222ASD | Wrench, Combination 11/16" 12 PT | ASME B107.100 | AS 954 |
| J1224ASD | Wrench, Combination 3/4" 12 PT | ASME B107.100 | AS 954 |
| J5320-50 | Socket, 1/2" DR Spark Plug 5/8" | ASME B107.34 | |
| J5414 | Socket, 1/2" DR 7/16" 12 PT | ASME B107.1 | AS954E S3.8.1 |
| J5416 | Socket, 1/2" DR 1/2" 12 PT | ASME B107.1 | AS954E S3.8.1 |
| J5418 | Socket, 1/2" DR 9/16" 12 PT | ASME B107.1 | AS954E S3.8.1 |
| J5420 | Socket, 1/2" DR 5/8" 12 PT | ASME B107.1 | AS954E S3.8.1 |
| J5422 | Socket, 1/2" DR 11/16" 12 PT | ASME B107.1 | AS954E S3.8.1 |
| J5424 | Socket, 1/2" DR 3/4" 12 PT | ASME B107.1 | AS954E S3.8.1 |
| J5426 | Socket, 1/2" DR 13/16" 12 PT | ASME B107.1 | AS954E S3.8.1 |
| J5428 | Socket, 1/2" DR 7/8" 12 PT | ASME B107.1 | AS954E S3.8.1 |
| J5430 | Socket, 1/2" DR 15/16" 12 PT | ASME B107.1 | AS954E S3.8.1 |
| J5432 | Socket, 1/2" DR 1" 12 PT | ASME B107.1 | AS954E S3.8.1 |
| J5434 | Socket, 1/2" DR 1-1/16" 12 PT | ASME B107.1 | AS954E S3.8.1 |
| J5436 | Socket, 1/2" DR 1-1/8" 12 PT | ASME B107.1 | AS954E S3.8.1 |
| J5440 | Socket, 1/2" DR 1-1/4" 12 PT | ASME B107.1 | AS954E S3.8.1 |
| J5449 | Ratchet, 1/2" DR Standard Length Classic Pear Head 10" | ASME B107.500 | |
| J5461 | Extension, 1/2" DR 5" | ASME B107.500 | AS 4283 |
| J5463 | Extension, 1/2" DR 10" | ASME B107.500 | AS 4283 |
| J5467 | Handle, Hinge 1/2" DR 15-3/4" | ASME B107.500 | AS 4283 |
| J5470A | Socket, 1/2" DR Universal Joint | ASME B107.500 | |
| J5496 | Set Box | | |



1/2" DRIVE 26 PIECE SOCKET SET - 12 POINT

Product #: J54124



- › 12 Point Standard: 3/8, 7/16, 1/2, 9/16, 19/32, 5/8, 21/32, 11/16, 3/4, 25/32, 13/16, 7/8, 15/16, 31/32, 1, 1-1/16, 1-1/8, 1-3/16, 1-1/4 Inch.
- › Accessories: Pear Head Ratchet, 2-1/2, 5, and 10 Inch Extensions, Hinge Handle, Universal Joint, Speed Handle, and Metal Box.
- › Weight (lbs): 17.69



| Contents | Description | ASME Spec. | AS Spec. |
|----------|--|---------------|---------------|
| J5412 | Socket, 1/2" DR 3/8" 12 PT | ASME B107.1 | AS954E S3.8.1 |
| J5414 | Socket, 1/2" DR 7/16" 12 PT | ASME B107.1 | AS954E S3.8.1 |
| J5416 | Socket, 1/2" DR 1/2" 12 PT | ASME B107.1 | AS954E S3.8.1 |
| J5418 | Socket, 1/2" DR 9/16" 12 PT | ASME B107.1 | AS954E S3.8.1 |
| J5419 | Socket, 1/2" DR 19/32" 12 PT | ASME B107.1 | AS954E S3.8.1 |
| J5420 | Socket, 1/2" DR 5/8" 12 PT | ASME B107.1 | AS954E S3.8.1 |
| J5421 | Socket, 1/2" DR 21/32" 12 PT | ASME B107.1 | AS954E S3.8.1 |
| J5422 | Socket, 1/2" DR 11/16" 12 PT | ASME B107.1 | AS954E S3.8.1 |
| J5424 | Socket, 1/2" DR 3/4" 12 PT | ASME B107.1 | AS954E S3.8.1 |
| J5425 | Socket, 1/2" DR 25/32" 12 PT | ASME B107.1 | AS954E S3.8.1 |
| J5426 | Socket, 1/2" DR 13/16" 12 PT | ASME B107.1 | AS954E S3.8.1 |
| J5428 | Socket, 1/2" DR 7/8" 12 PT | ASME B107.1 | AS954E S3.8.1 |
| J5430 | Socket, 1/2" DR 15/16" 12 PT | ASME B107.1 | AS954E S3.8.1 |
| J5431 | Socket, 1/2" DR 31/32" 12 PT | ASME B107.1 | AS954E S3.8.1 |
| J5432 | Socket, 1/2" DR 1" 12 PT | ASME B107.1 | AS954E S3.8.1 |
| J5434 | Socket, 1/2" DR 1-1/16" 12 PT | ASME B107.1 | AS954E S3.8.1 |
| J5436 | Socket, 1/2" DR 1-1/8" 12 PT | ASME B107.1 | AS954E S3.8.1 |
| J5438 | Socket, 1/2" DR 1-3/16" 12 PT | ASME B107.1 | AS954E S3.8.1 |
| J5440 | Socket, 1/2" DR 1-1/4" 12 PT | ASME B107.1 | AS954E S3.8.1 |
| J5449 | Ratchet, 1/2" DR Standard Length Classic Pear Head 10" | ASME B107.500 | |
| J5460 | Extension, 1/2" DR 2-1/2" | ASME B107.500 | AS 4283 |
| J5461 | Extension, 1/2" DR 5" | ASME B107.500 | AS 4283 |
| J5463 | Extension, 1/2" DR 10" | ASME B107.500 | AS 4283 |
| J5468 | Hinge Handle, 1/2" DR 18-5/8" | ASME B107.500 | AS 4283 |
| J5470A | Socket, 1/2" DR Universal Joint | ASME B107.500 | |
| J5480G | Handle, Speed 1/2" DR 18" | ASME B107.500 | |
| J5496 | Set Box | | |



1/2" DRIVE 22 PIECE METRIC SOCKET SET - 12 POINT

METRIC



Product #: J54210

- ▶ 12 Point Standard: 10, 11, 12, 13, 14, 15, 16, 17, 18, 19, 20, 21, 22, 23, 24, 25, 26 mm.
- ▶ Accessories: Pear Head Ratchet, 5 and 10 Inch Extensions, Hinge Handle, Universal Joint, and Metal Box.
- ▶ Weight (lbs): 15.21



| Contents | Description | ASME Spec. | AS Spec. |
|----------|--|---------------|---------------|
| J5410M | Socket, 1/2" DR 10 mm 12 PT | ASME B107.5M | AS954E S3.8.1 |
| J5411M | Socket, 1/2" DR 11 mm 12 PT | ASME B107.5M | AS954E S3.8.1 |
| J5412M | Socket, 1/2" DR 12 mm 12 PT | ASME B107.5M | AS954E S3.8.1 |
| J5413M | Socket, 1/2" DR 13 mm 12 PT | ASME B107.5M | AS954E S3.8.1 |
| J5414M | Socket, 1/2" DR 14 mm 12 PT | ASME B107.5M | AS954E S3.8.1 |
| J5415M | Socket, 1/2" DR 15 mm 12 PT | ASME B107.5M | AS954E S3.8.1 |
| J5416M | Socket, 1/2" DR 16 mm 12 PT | ASME B107.5M | AS954E S3.8.1 |
| J5417M | Socket, 1/2" DR 17 mm 12 PT | ASME B107.5M | AS954E S3.8.1 |
| J5418M | Socket, 1/2" DR 18 mm 12 PT | ASME B107.5M | AS954E S3.8.1 |
| J5419M | Socket, 1/2" DR 19 mm 12 PT | ASME B107.5M | AS954E S3.8.1 |
| J5420M | Socket, 1/2" DR 20 mm 12 PT | ASME B107.5M | AS954E S3.8.1 |
| J5421M | Socket, 1/2" DR 21 mm 12 PT | ASME B107.5M | AS954E S3.8.1 |
| J5422M | Socket, 1/2" DR 22 mm 12 PT | ASME B107.5M | AS954E S3.8.1 |
| J5423M | Socket, 1/2" DR 23 mm 12 PT | ASME B107.5M | AS954E S3.8.1 |
| J5424M | Socket, 1/2" DR 24 mm 12 PT | ASME B107.5M | AS954E S3.8.1 |
| J5425M | Socket, 1/2" DR 25 mm 12 PT | ASME B107.5M | AS954E S3.8.1 |
| J5426M | Socket, 1/2" DR 26 mm 12 PT | ASME B107.5M | AS954E S3.8.1 |
| J5449 | Ratchet, 1/2" DR Standard Length Classic Pear Head 10" | ASME B107.500 | |
| J5461 | Extension, 1/2" DR 5" | ASME B107.500 | AS 4283 |
| J5463 | Extension, 1/2" DR 10" | ASME B107.500 | AS 4283 |
| J5468 | Handle, Hinge 1/2" DR 18-5/8" | ASME B107.500 | AS 4283 |
| J5470A | Socket, 1/2" DR Universal Joint | ASME B107.500 | |
| J5496 | Set Box | | |





1/2" DRIVE 18 PIECE SOCKET SET - 12 POINT

Product #: J54120

- › 12 Point Standard: 3/8, 7/16, 1/2, 9/16, 5/8, 11/16, 3/4, 13/16, 7/8, 15/16, 1, 1-1/16, 1-1/8, 1-3/16, 1-1/4 Inch.
- › Accessories: Pear Head Ratchet, 5 Inch Extension, 15-3/4 Inch Hinge Handle, and Blow-Molded Case.
- › Weight (lbs): 11.80



| Contents | Description | ASME Spec. | AS Spec. |
|----------|--|---------------|---------------|
| J5412 | Socket, 1/2" DR 3/8" 12 PT | ASME B107.1 | AS954E S3.8.1 |
| J5414 | Socket, 1/2" DR 7/16" 12 PT | ASME B107.1 | AS954E S3.8.1 |
| J5416 | Socket, 1/2" DR 1/2" 12 PT | ASME B107.1 | AS954E S3.8.1 |
| J5418 | Socket, 1/2" DR 9/16" 12 PT | ASME B107.1 | AS954E S3.8.1 |
| J5420 | Socket, 1/2" DR 5/8" 12 PT | ASME B107.1 | AS954E S3.8.1 |
| J5422 | Socket, 1/2" DR 11/16" 12 PT | ASME B107.1 | AS954E S3.8.1 |
| J5424 | Socket, 1/2" DR 3/4" 12 PT | ASME B107.1 | AS954E S3.8.1 |
| J5426 | Socket, 1/2" DR 13/16" 12 PT | ASME B107.1 | AS954E S3.8.1 |
| J5428 | Socket, 1/2" DR 7/8" 12 PT | ASME B107.1 | AS954E S3.8.1 |
| J5430 | Socket, 1/2" DR 15/16" 12 PT | ASME B107.1 | AS954E S3.8.1 |
| J5432 | Socket, 1/2" DR 1" 12 PT | ASME B107.1 | AS954E S3.8.1 |
| J5434 | Socket, 1/2" DR 1-1/16" 12 PT | ASME B107.1 | AS954E S3.8.1 |
| J5436 | Socket, 1/2" DR 1-1/8" 12 PT | ASME B107.1 | AS954E S3.8.1 |
| J5438 | Socket, 1/2" DR 1-3/16" 12 PT | ASME B107.1 | AS954E S3.8.1 |
| J5440 | Socket, 1/2" DR 1-1/4" 12 PT | ASME B107.1 | AS954E S3.8.1 |
| J5449 | Ratchet, 1/2" DR Standard Length Classic Pear Head 10" | ASME B107.500 | |
| J5461 | Extension, 1/2" DR 5" | ASME B107.500 | AS 4283 |
| J5467 | Handle, Hinge 1/2" DR 15-3/4" | ASME B107.500 | AS 4283 |
| JBM1204 | Blow-Molded Case | | |

1/2" DRIVE 18 PIECE SOCKET SET - 12 POINT

Product #: J54120XL

- › 12 Point Standard: 3/8, 7/16, 1/2, 9/16, 5/8, 11/16, 3/4, 13/16, 7/8, 15/16, 1, 1-1/16, 1-1/8, 1-3/16, 1-1/4 Inch.
- › Accessories: Premium Ratchet, 5 Inch Extension, Hinge Handle, and Blow-Molded Case.
- › Weight (lbs): 11.77



| Contents | Description | ASME Spec. | AS Spec. |
|----------|--|---------------|---------------|
| J5412 | Socket, 1/2" DR 3/8" 12 PT | ASME B107.1 | AS954E S3.8.1 |
| J5414 | Socket, 1/2" DR 7/16" 12 PT | ASME B107.1 | AS954E S3.8.1 |
| J5416 | Socket, 1/2" DR 1/2" 12 PT | ASME B107.1 | AS954E S3.8.1 |
| J5418 | Socket, 1/2" DR 9/16" 12 PT | ASME B107.1 | AS954E S3.8.1 |
| J5420 | Socket, 1/2" DR 5/8" 12 PT | ASME B107.1 | AS954E S3.8.1 |
| J5422 | Socket, 1/2" DR 11/16" 12 PT | ASME B107.1 | AS954E S3.8.1 |
| J5424 | Socket, 1/2" DR 3/4" 12 PT | ASME B107.1 | AS954E S3.8.1 |
| J5426 | Socket, 1/2" DR 13/16" 12 PT | ASME B107.1 | AS954E S3.8.1 |
| J5428 | Socket, 1/2" DR 7/8" 12 PT | ASME B107.1 | AS954E S3.8.1 |
| J5430 | Socket, 1/2" DR 15/16" 12 PT | ASME B107.1 | AS954E S3.8.1 |
| J5432 | Socket, 1/2" DR 1" 12 PT | ASME B107.1 | AS954E S3.8.1 |
| J5434 | Socket, 1/2" DR 1-1/16" 12 PT | ASME B107.1 | AS954E S3.8.1 |
| J5436 | Socket, 1/2" DR 1-1/8" 12 PT | ASME B107.1 | AS954E S3.8.1 |
| J5438 | Socket, 1/2" DR 1-3/16" 12 PT | ASME B107.1 | AS954E S3.8.1 |
| J5440 | Socket, 1/2" DR 1-1/4" 12 PT | ASME B107.1 | AS954E S3.8.1 |
| J5449XL | Ratchet, 1/2" DR Standard Length Premium Pear Head 10-1/2" | ASME B107.500 | |
| J5461 | Extension, 1/2" DR 5" | ASME B107.500 | AS 4283 |
| J5467 | Handle, Hinge 1/2" DR 15-3/4" | ASME B107.500 | AS 4283 |
| JBM1204 | Blow-Molded Case | | |



1/2" DRIVE 18 PIECE SOCKET SET - 6 POINT

Product #: J54122

- ▶ 6 Point Standard: 3/8, 7/16, 1/2, 9/16, 5/8, 11/16, 3/4, 13/16, 7/8, 15/16, 1, 1-1/16, 1-1/8, 1-3/16, 1-1/4 Inch.
- ▶ Accessories: Pear Head Ratchet, 5 Inch Extension, Hinge Handle, and Blow-Molded Case.
- ▶ Weight (lbs): 12.04



| Contents | Description | ASME Spec. | AS Spec. |
|----------|--|---------------|----------|
| J5412H | Socket, 1/2" DR 3/8" 6 PT | ASME B107.1 | |
| J5414H | Socket, 1/2" DR 7/16" 6 PT | ASME B107.1 | |
| J5416H | Socket, 1/2" DR 1/2" 6 PT | ASME B107.1 | |
| J5418H | Socket, 1/2" DR 9/16" 6 PT | ASME B107.1 | |
| J5420H | Socket, 1/2" DR 5/8" 6 PT | ASME B107.1 | |
| J5422H | Socket, 1/2" DR 11/16" 6 PT | ASME B107.1 | |
| J5424H | Socket, 1/2" DR 3/4" 6 PT | ASME B107.1 | |
| J5426H | Socket, 1/2" DR 13/16" 6 PT | ASME B107.1 | |
| J5428H | Socket, 1/2" DR 7/8" 6 PT | ASME B107.1 | |
| J5430H | Socket, 1/2" DR 15/16" 6 PT | ASME B107.1 | |
| J5432H | Socket, 1/2" DR 1" 6 PT | ASME B107.1 | |
| J5434H | Socket, 1/2" DR 1-1/16" 6 PT | ASME B107.1 | |
| J5436H | Socket, 1/2" DR 1-1/8" 6 PT | ASME B107.1 | |
| J5438H | Socket, 1/2" DR 1-3/16" 6 PT | ASME B107.1 | |
| J5440H | Socket, 1/2" DR 1-1/4" 6 PT | ASME B107.1 | |
| J5449 | Ratchet, 1/2" DR Standard Length Classic Pear Head 10" | ASME B107.500 | |
| J5461 | Extension, 1/2" DR 5" | ASME B107.500 | AS 4283 |
| J5467 | Handle, Hinge 1/2" DR 15-3/4" | ASME B107.500 | AS 4283 |
| JBM1204 | Blow-Molded Case | | |

1/2" DRIVE 18 PIECE SOCKET SET - 6 POINT

Product #: J54122XL

- ▶ 6 Point Standard: 3/8, 7/16, 1/2, 9/16, 5/8, 11/16, 3/4, 13/16, 7/8, 15/16, 1, 1-1/16, 1-1/8, 1-3/16, 1-1/4 Inch.
- ▶ Accessories: Premium Ratchet, 5 Inch Extension, Hinge Handle, and Blow-Molded Case.
- ▶ Weight (lbs): 12.02



| Contents | Description | ASME Spec. | AS Spec. |
|----------|--|---------------|----------|
| J5412H | Socket, 1/2" DR 3/8" 6 PT | ASME B107.1 | |
| J5414H | Socket, 1/2" DR 7/16" 6 PT | ASME B107.1 | |
| J5416H | Socket, 1/2" DR 1/2" 6 PT | ASME B107.1 | |
| J5418H | Socket, 1/2" DR 9/16" 6 PT | ASME B107.1 | |
| J5420H | Socket, 1/2" DR 5/8" 6 PT | ASME B107.1 | |
| J5422H | Socket, 1/2" DR 11/16" 6 PT | ASME B107.1 | |
| J5424H | Socket, 1/2" DR 3/4" 6 PT | ASME B107.1 | |
| J5426H | Socket, 1/2" DR 13/16" 6 PT | ASME B107.1 | |
| J5428H | Socket, 1/2" DR 7/8" 6 PT | ASME B107.1 | |
| J5430H | Socket, 1/2" DR 15/16" 6 PT | ASME B107.1 | |
| J5432H | Socket, 1/2" DR 1" 6 PT | ASME B107.1 | |
| J5434H | Socket, 1/2" DR 1-1/16" 6 PT | ASME B107.1 | |
| J5436H | Socket, 1/2" DR 1-1/8" 6 PT | ASME B107.1 | |
| J5438H | Socket, 1/2" DR 1-3/16" 6 PT | ASME B107.1 | |
| J5440H | Socket, 1/2" DR 1-1/4" 6 PT | ASME B107.1 | |
| J5449XL | Ratchet, 1/2" DR Standard Length Premium Pear Head 10-1/2" | ASME B107.500 | |
| J5461 | Extension, 1/2" DR 5" | ASME B107.500 | AS 4283 |
| J5467 | Handle, Hinge 1/2" DR 15-3/4" | ASME B107.500 | AS 4283 |
| JBM1204 | Blow-Molded Case | | |



1/2" DRIVE 16 PIECE SOCKET SET - 12 POINT

Product #: J54118

- › 12 Point Standard: 7/16, 1/2, 9/16, 5/8, 11/16, 3/4, 13/16, 7/8, 15/16, 1 Inch.
- › Accessories: Pear Head Ratchet, 5 and 10 Inch Extensions, Hinge Handle, Universal Joint, Speed Handle, and Blow-Molded Case.
- › Weight (lbs): 13.48



| Contents | Description | ASME Spec. | AS Spec. |
|----------|--|---------------|---------------|
| J5414 | Socket, 1/2" DR 7/16" 12 PT | ASME B107.1 | AS954E S3.8.1 |
| J5416 | Socket, 1/2" DR 1/2" 12 PT | ASME B107.1 | AS954E S3.8.1 |
| J5418 | Socket, 1/2" DR 9/16" 12 PT | ASME B107.1 | AS954E S3.8.1 |
| J5420 | Socket, 1/2" DR 5/8" 12 PT | ASME B107.1 | AS954E S3.8.1 |
| J5422 | Socket, 1/2" DR 11/16" 12 PT | ASME B107.1 | AS954E S3.8.1 |
| J5424 | Socket, 1/2" DR 3/4" 12 PT | ASME B107.1 | AS954E S3.8.1 |
| J5426 | Socket, 1/2" DR 13/16" 12 PT | ASME B107.1 | AS954E S3.8.1 |
| J5428 | Socket, 1/2" DR 7/8" 12 PT | ASME B107.1 | AS954E S3.8.1 |
| J5430 | Socket, 1/2" DR 15/16" 12 PT | ASME B107.1 | AS954E S3.8.1 |
| J5432 | Socket, 1/2" DR 1" 12 PT | ASME B107.1 | AS954E S3.8.1 |
| J5449 | Ratchet, 1/2" DR Standard Length Classic Pear Head 10" | ASME B107.500 | |
| J5461 | Extension, 1/2" DR 5" | ASME B107.500 | AS 4283 |
| J5463 | Extension, 1/2" DR 10" | ASME B107.500 | AS 4283 |
| J5467 | Handle, Hinge 1/2" DR 15-3/4" | ASME B107.500 | AS 4283 |
| J5470A | Socket, 1/2" DR Universal Joint | ASME B107.500 | |
| J5480G | Handle, Speed 1/2" DR 18" | ASME B107.500 | |
| JBM1208 | Blow-Molded Case | | |

1/2" DRIVE 16 PIECE SOCKET SET - 12 POINT

Product #: J54118XL

- › 12 Point Standard: 7/16, 1/2, 9/16, 5/8, 11/16, 3/4, 13/16, 7/8, 15/16, 1 Inch.
- › Accessories: Premium Ratchet, 5 and 10 Inch Extensions, Universal Joint, Hinge Handle, Speed Handle, and Blow-Molded Case.
- › Weight (lbs): 14.11



| Contents | Description | ASME Spec. | AS Spec. |
|----------|--|---------------|---------------|
| J5414 | Socket, 1/2" DR 7/16" 12 PT | ASME B107.1 | AS954E S3.8.1 |
| J5416 | Socket, 1/2" DR 1/2" 12 PT | ASME B107.1 | AS954E S3.8.1 |
| J5418 | Socket, 1/2" DR 9/16" 12 PT | ASME B107.1 | AS954E S3.8.1 |
| J5420 | Socket, 1/2" DR 5/8" 12 PT | ASME B107.1 | AS954E S3.8.1 |
| J5422 | Socket, 1/2" DR 11/16" 12 PT | ASME B107.1 | AS954E S3.8.1 |
| J5424 | Socket, 1/2" DR 3/4" 12 PT | ASME B107.1 | AS954E S3.8.1 |
| J5426 | Socket, 1/2" DR 13/16" 12 PT | ASME B107.1 | AS954E S3.8.1 |
| J5428 | Socket, 1/2" DR 7/8" 12 PT | ASME B107.1 | AS954E S3.8.1 |
| J5430 | Socket, 1/2" DR 15/16" 12 PT | ASME B107.1 | AS954E S3.8.1 |
| J5432 | Socket, 1/2" DR 1" 12 PT | ASME B107.1 | AS954E S3.8.1 |
| J5449XL | Ratchet, 1/2" DR Standard Length Premium Pear Head 10-1/2" | ASME B107.500 | |
| J5461 | Extension, 1/2" DR 5" | ASME B107.500 | AS 4283 |
| J5463 | Extension, 1/2" DR 10" | ASME B107.500 | AS 4283 |
| J5467 | Handle, Hinge 1/2" DR 15-3/4" | ASME B107.500 | AS 4283 |
| J5470A | Socket, 1/2" DR Universal Joint | ASME B107.500 | |
| J5480G | Handle, Speed 1/2" DR 18" | ASME B107.500 | AS4283 |
| JBM1208 | Blow-Molded Case | | |



1/2" DRIVE 16 PIECE METRIC SOCKET SET - 12 POINT

METRIC



Product #: J54208

- › 12 Point Standard: 10, 11, 12, 13, 14, 15, 16, 17, 18, 19, 20, 21, 22, 23 mm.
- › Accessories: Pear Head Ratchet, 5 Inch Extension, and Blow-Molded Case.
- › Weight (lbs): 7.32



| Contents | Description | ASME Spec. | AS Spec. |
|----------|--|---------------|---------------|
| J5410M | Socket, 1/2" DR 10 mm 12 PT | ASME B107.5M | AS954E S3.8.1 |
| J5411M | Socket, 1/2" DR 11 mm 12 PT | ASME B107.5M | AS954E S3.8.1 |
| J5412M | Socket, 1/2" DR 12 mm 12 PT | ASME B107.5M | AS954E S3.8.1 |
| J5413M | Socket, 1/2" DR 13 mm 12 PT | ASME B107.5M | AS954E S3.8.1 |
| J5414M | Socket, 1/2" DR 14 mm 12 PT | ASME B107.5M | AS954E S3.8.1 |
| J5415M | Socket, 1/2" DR 15 mm 12 PT | ASME B107.5M | AS954E S3.8.1 |
| J5416M | Socket, 1/2" DR 16 mm 12 PT | ASME B107.5M | AS954E S3.8.1 |
| J5417M | Socket, 1/2" DR 17 mm 12 PT | ASME B107.5M | AS954E S3.8.1 |
| J5418M | Socket, 1/2" DR 18 mm 12 PT | ASME B107.5M | AS954E S3.8.1 |
| J5419M | Socket, 1/2" DR 19 mm 12 PT | ASME B107.5M | AS954E S3.8.1 |
| J5420M | Socket, 1/2" DR 20 mm 12 PT | ASME B107.5M | AS954E S3.8.1 |
| J5421M | Socket, 1/2" DR 21 mm 12 PT | ASME B107.5M | AS954E S3.8.1 |
| J5422M | Socket, 1/2" DR 22 mm 12 PT | ASME B107.5M | AS954E S3.8.1 |
| J5423M | Socket, 1/2" DR 23 mm 12 PT | ASME B107.5M | AS954E S3.8.1 |
| J5449 | Ratchet, 1/2" DR Standard Length Classic Pear Head 10" | ASME B107.500 | |
| J5461 | Extension, 1/2" DR 5" | ASME B107.500 | AS 4283 |
| JBM1202 | Blow-Molded Case | | |

1/2" DRIVE 16 PIECE METRIC SOCKET SET - 12 POINT

METRIC



Product #: J54208XL

- › 12 Point Standard: 10, 11, 12, 13, 14, 15, 16, 17, 18, 19, 20, 21, 22, 23 mm.
- › Accessories: Premium Ratchet, 5 Inch Extension, and Blow-Molded Case.
- › Weight (lbs): 7.52



| Contents | Description | ASME Spec. | AS Spec. |
|----------|--|---------------|---------------|
| J5410M | Socket, 1/2" DR 10 mm 12 PT | ASME B107.5M | AS954E S3.8.1 |
| J5411M | Socket, 1/2" DR 11 mm 12 PT | ASME B107.5M | AS954E S3.8.1 |
| J5412M | Socket, 1/2" DR 12 mm 12 PT | ASME B107.5M | AS954E S3.8.1 |
| J5413M | Socket, 1/2" DR 13 mm 12 PT | ASME B107.5M | AS954E S3.8.1 |
| J5414M | Socket, 1/2" DR 14 mm 12 PT | ASME B107.5M | AS954E S3.8.1 |
| J5415M | Socket, 1/2" DR 15 mm 12 PT | ASME B107.5M | AS954E S3.8.1 |
| J5416M | Socket, 1/2" DR 16 mm 12 PT | ASME B107.5M | AS954E S3.8.1 |
| J5417M | Socket, 1/2" DR 17 mm 12 PT | ASME B107.5M | AS954E S3.8.1 |
| J5418M | Socket, 1/2" DR 18 mm 12 PT | ASME B107.5M | AS954E S3.8.1 |
| J5419M | Socket, 1/2" DR 19 mm 12 PT | ASME B107.5M | AS954E S3.8.1 |
| J5420M | Socket, 1/2" DR 20 mm 12 PT | ASME B107.5M | AS954E S3.8.1 |
| J5421M | Socket, 1/2" DR 21 mm 12 PT | ASME B107.5M | AS954E S3.8.1 |
| J5422M | Socket, 1/2" DR 22 mm 12 PT | ASME B107.5M | AS954E S3.8.1 |
| J5423M | Socket, 1/2" DR 23 mm 12 PT | ASME B107.5M | AS954E S3.8.1 |
| J5449XL | Ratchet, 1/2" DR Standard Length Premium Pear Head 10-1/2" | ASME B107.500 | |
| J5461 | Extension, 1/2" DR 5" | ASME B107.500 | AS 4283 |
| JBM1202 | Blow-Molded Case | | |





1/2" DRIVE 12 PIECE SOCKET SET - 12 POINT

Product #: J54116

- › 12 Point Standard: 7/16, 1/2, 9/16, 5/8, 11/16, 3/4, 13/16, 7/8, 15/16, 1 Inch.
- › Accessories: Pear Head Ratchet, 5 Inch Extension, and Blow-Molded Case.
- › Weight (lbs): 5.88



| Contents | Description | ASME Spec. | AS Spec. |
|----------|--|---------------|---------------|
| J5414 | Socket, 1/2" DR 7/16" 12 PT | ASME B107.1 | AS954E S3.8.1 |
| J5416 | Socket, 1/2" DR 1/2" 12 PT | ASME B107.1 | AS954E S3.8.1 |
| J5418 | Socket, 1/2" DR 9/16" 12 PT | ASME B107.1 | AS954E S3.8.1 |
| J5420 | Socket, 1/2" DR 5/8" 12 PT | ASME B107.1 | AS954E S3.8.1 |
| J5422 | Socket, 1/2" DR 11/16" 12 PT | ASME B107.1 | AS954E S3.8.1 |
| J5424 | Socket, 1/2" DR 3/4" 12 PT | ASME B107.1 | AS954E S3.8.1 |
| J5426 | Socket, 1/2" DR 13/16" 12 PT | ASME B107.1 | AS954E S3.8.1 |
| J5428 | Socket, 1/2" DR 7/8" 12 PT | ASME B107.1 | AS954E S3.8.1 |
| J5430 | Socket, 1/2" DR 15/16" 12 PT | ASME B107.1 | AS954E S3.8.1 |
| J5432 | Socket, 1/2" DR 1" 12 PT | ASME B107.1 | AS954E S3.8.1 |
| J5449 | Ratchet, 1/2" DR Standard Length Classic Pear Head 10" | ASME B107.500 | |
| J5461 | Extension, 1/2" DR 5" | ASME B107.500 | AS 4283 |
| JBM1201 | Blow-Molded Case | | |

1/2" DRIVE 12 PIECE SOCKET SET - 12 POINT

Product #: J54116XL

- › 12 Point Standard: 7/16, 1/2, 9/16, 5/8, 11/16, 3/4, 13/16, 7/8, 15/16, 1 Inch.
- › Accessories: Premium Ratchet, 5 Inch Extension, and Blow-Molded Case.
- › Weight (lbs): 6.22



| Contents | Description | ASME Spec. | AS Spec. |
|----------|--|---------------|---------------|
| J5414 | Socket, 1/2" DR 7/16" 12 PT | ASME B107.1 | AS954E S3.8.1 |
| J5416 | Socket, 1/2" DR 1/2" 12 PT | ASME B107.1 | AS954E S3.8.1 |
| J5418 | Socket, 1/2" DR 9/16" 12 PT | ASME B107.1 | AS954E S3.8.1 |
| J5420 | Socket, 1/2" DR 5/8" 12 PT | ASME B107.1 | AS954E S3.8.1 |
| J5422 | Socket, 1/2" DR 11/16" 12 PT | ASME B107.1 | AS954E S3.8.1 |
| J5424 | Socket, 1/2" DR 3/4" 12 PT | ASME B107.1 | AS954E S3.8.1 |
| J5426 | Socket, 1/2" DR 13/16" 12 PT | ASME B107.1 | AS954E S3.8.1 |
| J5428 | Socket, 1/2" DR 7/8" 12 PT | ASME B107.1 | AS954E S3.8.1 |
| J5430 | Socket, 1/2" DR 15/16" 12 PT | ASME B107.1 | AS954E S3.8.1 |
| J5432 | Socket, 1/2" DR 1" 12 PT | ASME B107.1 | AS954E S3.8.1 |
| J5449XL | Ratchet, 1/2" DR Standard Length Premium Pear Head 10-1/2" | ASME B107.500 | |
| J5461 | Extension, 1/2" DR 5" | ASME B107.500 | AS 4283 |
| JBM1201 | Blow-Molded Case | | |



1/2" DRIVE 24 PIECE METRIC SOCKET SET - 12 POINT

METRIC



Product #: J54211

- › 12 Point Standard: 10, 11, 12, 13, 14, 15, 16, 17, 18, 19, 20, 21, 22, 23, 24, 25, 26, 27, 28, 29, 30, 31, 32, 36 mm.
- › Accessories: (2) 17 Inch Socket Bars with 24 Socket Clips.
- › Weight (lbs): 7.69



| Contents | Description | ASME Spec. | AS Spec. |
|----------|-----------------------------|--------------|---------------|
| J5410M | Socket, 1/2" DR 10 mm 12 PT | ASME B107.5M | AS954E S3.8.1 |
| J5411M | Socket, 1/2" DR 11 mm 12 PT | ASME B107.5M | AS954E S3.8.1 |
| J5412M | Socket, 1/2" DR 12 mm 12 PT | ASME B107.5M | AS954E S3.8.1 |
| J5413M | Socket, 1/2" DR 13 mm 12 PT | ASME B107.5M | AS954E S3.8.1 |
| J5414M | Socket, 1/2" DR 14 mm 12 PT | ASME B107.5M | AS954E S3.8.1 |
| J5415M | Socket, 1/2" DR 15 mm 12 PT | ASME B107.5M | AS954E S3.8.1 |
| J5416M | Socket, 1/2" DR 16 mm 12 PT | ASME B107.5M | AS954E S3.8.1 |
| J5417M | Socket, 1/2" DR 17 mm 12 PT | ASME B107.5M | AS954E S3.8.1 |
| J5418M | Socket, 1/2" DR 18 mm 12 PT | ASME B107.5M | AS954E S3.8.1 |
| J5419M | Socket, 1/2" DR 19 mm 12 PT | ASME B107.5M | AS954E S3.8.1 |
| J5420M | Socket, 1/2" DR 20 mm 12 PT | ASME B107.5M | AS954E S3.8.1 |
| J5421M | Socket, 1/2" DR 21 mm 12 PT | ASME B107.5M | AS954E S3.8.1 |
| J5422M | Socket, 1/2" DR 22 mm 12 PT | ASME B107.5M | AS954E S3.8.1 |
| J5423M | Socket, 1/2" DR 23 mm 12 PT | ASME B107.5M | AS954E S3.8.1 |
| J5424M | Socket, 1/2" DR 24 mm 12 PT | ASME B107.5M | AS954E S3.8.1 |
| J5425M | Socket, 1/2" DR 25 mm 12 PT | ASME B107.5M | AS954E S3.8.1 |
| J5426M | Socket, 1/2" DR 26 mm 12 PT | ASME B107.5M | AS954E S3.8.1 |
| J5427M | Socket, 1/2" DR 27 mm 12 PT | ASME B107.5M | AS954E S3.8.1 |
| J5428M | Socket, 1/2" DR 28 mm 12 PT | ASME B107.5M | AS954E S3.8.1 |
| J5429M | Socket, 1/2" DR 29 mm 12 PT | ASME B107.5M | AS954E S3.8.1 |
| J5430M | Socket, 1/2" DR 30 mm 12 PT | ASME B107.5M | AS954E S3.8.1 |
| J5431M | Socket, 1/2" DR 31 mm 12 PT | ASME B107.5M | AS954E S3.8.1 |
| J5432M | Socket, 1/2" DR 32 mm 12 PT | ASME B107.5M | AS954E S3.8.1 |
| J5436M | Socket, 1/2" DR 36 mm 12 PT | ASME B107.5M | AS954E S3.8.1 |
| J2586 | Socket, Bar 13" | | |
| J2587 | Socket, Bar 17" | | |
| J2592 | Socket, Clip 1/2" DR | | |





1/2" DRIVE 23 PIECE METRIC SOCKET SET - 6 POINT



Product #: J54209

- › 6 Point Standard: 10, 11, 12, 13, 14, 15, 16, 17, 18, 19, 20, 21, 22, 23, 24, 25, 26, 27, 28, 29, 30, 31, 32 mm.
- › Accessories: 13 and 17 Inch Socket Bars with 23 Socket Clips.
- › Weight (lbs): 6.97



| Contents | Description | ASME Spec. |
|----------|----------------------------|--------------|
| J5408MH | Socket, 1/2" DR 8 mm 6 PT | ASME B107.5M |
| J5409MH | Socket, 1/2" DR 9 mm 6 PT | ASME B107.5M |
| J5410MH | Socket, 1/2" DR 10 mm 6 PT | ASME B107.5M |
| J5411MH | Socket, 1/2" DR 11 mm 6 PT | ASME B107.5M |
| J5412MH | Socket, 1/2" DR 12 mm 6 PT | ASME B107.5M |
| J5413MH | Socket, 1/2" DR 13 mm 6 PT | ASME B107.5M |
| J5414MH | Socket, 1/2" DR 14 mm 6 PT | ASME B107.5M |
| J5415MH | Socket, 1/2" DR 15 mm 6 PT | ASME B107.5M |
| J5416MH | Socket, 1/2" DR 16 mm 6 PT | ASME B107.5M |
| J5417MH | Socket, 1/2" DR 17 mm 6 PT | ASME B107.5M |
| J5418MH | Socket, 1/2" DR 18 mm 6 PT | ASME B107.5M |
| J5419MH | Socket, 1/2" DR 19 mm 6 PT | ASME B107.5M |
| J5420MH | Socket, 1/2" DR 20 mm 6 PT | ASME B107.5M |
| J5421MH | Socket, 1/2" DR 21 mm 6 PT | ASME B107.5M |
| J5422MH | Socket, 1/2" DR 22 mm 6 PT | ASME B107.5M |
| J5423MH | Socket, 1/2" DR 23 mm 6 PT | ASME B107.5M |
| J5424MH | Socket, 1/2" DR 24 mm 6 PT | ASME B107.5M |
| J5425MH | Socket, 1/2" DR 25 mm 6 PT | ASME B107.5M |
| J5426MH | Socket, 1/2" DR 26 mm 6 PT | ASME B107.5M |
| J5427MH | Socket, 1/2" DR 27 mm 6 PT | ASME B107.5M |
| J5428MH | Socket, 1/2" DR 28 mm 6 PT | ASME B107.5M |
| J5429MH | Socket, 1/2" DR 29 mm 6 PT | ASME B107.5M |
| J5430MH | Socket, 1/2" DR 30 mm 6 PT | ASME B107.5M |
| J5431MH | Socket, 1/2" DR 31 mm 6 PT | ASME B107.5M |
| J5432MH | Socket, 1/2" DR 32 mm 6 PT | ASME B107.5M |
| J5434MH | Socket, 1/2" DR 34 mm 6 PT | ASME B107.5M |
| J5436MH | Socket, 1/2" DR 36 mm 6 PT | ASME B107.5M |
| J2586 | Socket, Bar 13" | |
| J2587 | Socket, Bar 17" | |
| J2592 | Socket, Clip 1/2" DR | |





1/2" DRIVE 19 PIECE DEEP SOCKET SET - 6 POINT

Product #: J54101

- ▶ 6 Point Deep: 3/8, 7/16, 1/2, 9/16, 5/8, 11/16, 3/4, 13/16, 7/8, 15/16, 1, 1-1/16, 1-1/8, 1-3/16, 1-1/4, 1-5/16, 1-3/8, 1-7/16, 1-1/2 Inch.
- ▶ Accessories: 17 Inch Socket Bar with 19 Socket Clips.
- ▶ Weight (lbs): 14.18



| Contents | Description | ASME Spec. |
|----------|-----------------------------------|-------------|
| J5312H | Socket, 1/2" DR 3/8" 6 PT Deep | ASME B107.1 |
| J5314H | Socket, 1/2" DR 7/16" 6 PT Deep | ASME B107.1 |
| J5316H | Socket, 1/2" DR 1/2" 6 PT Deep | ASME B107.1 |
| J5318H | Socket, 1/2" DR 9/16" 6 PT Deep | ASME B107.1 |
| J5320H | Socket, 1/2" DR 5/8" 6 PT Deep | ASME B107.1 |
| J5322H | Socket, 1/2" DR 11/16" 6 PT Deep | ASME B107.1 |
| J5324H | Socket, 1/2" DR 3/4" 6 PT Deep | ASME B107.1 |
| J5326H | Socket, 1/2" DR 13/16" 6 PT Deep | ASME B107.1 |
| J5328H | Socket, 1/2" DR 7/8" 6 PT Deep | ASME B107.1 |
| J5330H | Socket, 1/2" DR 15/16" 6 PT Deep | ASME B107.1 |
| J5332H | Socket, 1/2" DR 1" 6 PT Deep | ASME B107.1 |
| J5334H | Socket, 1/2" DR 1-1/16" 6 PT Deep | ASME B107.1 |
| J5336H | Socket, 1/2" DR 1-1/8" 6 PT Deep | ASME B107.1 |
| J5338H | Socket, 1/2" DR 1-3/16" 6 PT Deep | ASME B107.1 |
| J5340H | Socket, 1/2" DR 1-1/4" 6 PT Deep | ASME B107.1 |
| J5342H | Socket, 1/2" DR 1-5/16" 6 PT Deep | ASME B107.1 |
| J5344H | Socket, 1/2" DR 1-3/8" 6 PT Deep | ASME B107.1 |
| J5346H | Socket, 1/2" DR 1-7/16" 6 PT Deep | ASME B107.1 |
| J5348H | Socket, 1/2" DR 1-1/2" 6 PT Deep | ASME B107.1 |
| J2587 | Socket, Bar 17" | |
| J2592 | Socket, Clip 1/2" DR | |

1/2" DRIVE 15 PIECE DEEP SOCKET SET - 6 POINT

Product #: J54103

- ▶ 6 Point Deep: 3/8, 7/16, 1/2, 9/16, 5/8, 11/16, 3/4, 13/16, 7/8, 15/16, 1, 1-1/16, 1-1/8, 1-3/16, 1-1/4 Inch.
- ▶ Accessories: 17 Inch Socket Bar with 15 Socket Clips.
- ▶ Weight (lbs): 8.18



| Contents | Description | ASME Spec. |
|----------|-----------------------------------|-------------|
| J5312H | Socket, 1/2" DR 3/8" 6 PT Deep | ASME B107.1 |
| J5314H | Socket, 1/2" DR 7/16" 6 PT Deep | ASME B107.1 |
| J5316H | Socket, 1/2" DR 1/2" 6 PT Deep | ASME B107.1 |
| J5318H | Socket, 1/2" DR 9/16" 6 PT Deep | ASME B107.1 |
| J5320H | Socket, 1/2" DR 5/8" 6 PT Deep | ASME B107.1 |
| J5322H | Socket, 1/2" DR 11/16" 6 PT Deep | ASME B107.1 |
| J5324H | Socket, 1/2" DR 3/4" 6 PT Deep | ASME B107.1 |
| J5326H | Socket, 1/2" DR 13/16" 6 PT Deep | ASME B107.1 |
| J5328H | Socket, 1/2" DR 7/8" 6 PT Deep | ASME B107.1 |
| J5330H | Socket, 1/2" DR 15/16" 6 PT Deep | ASME B107.1 |
| J5332H | Socket, 1/2" DR 1" 6 PT Deep | ASME B107.1 |
| J5334H | Socket, 1/2" DR 1-1/16" 6 PT Deep | ASME B107.1 |
| J5336H | Socket, 1/2" DR 1-1/8" 6 PT Deep | ASME B107.1 |
| J5338H | Socket, 1/2" DR 1-3/16" 6 PT Deep | ASME B107.1 |
| J5340H | Socket, 1/2" DR 1-1/4" 6 PT Deep | ASME B107.1 |
| J2587 | Socket, Bar 17" | |
| J2592 | Socket, Clip 1/2" DR | |



1/2" DRIVE 19 PIECE DEEP SOCKET SET - 12 POINT

Product #: J54105

- ▶ 12 Point Deep: 3/8, 7/16, 1/2, 9/16, 5/8, 11/16, 3/4, 13/16, 7/8, 15/16, 1, 1-1/16, 1-1/8, 1-3/16, 1-1/4, 1-5/16, 1-3/8, 1-7/16, 1-1/2 Inch.
- ▶ Accessories: 17 Inch Socket Bar with 19 Socket Clips.
- ▶ Weight (lbs): 14.00



| Contents | Description | ASME Spec. | AS Spec. |
|----------|------------------------------------|-------------|---------------|
| J5312 | Socket, 1/2" DR 3/8" 12 PT Deep | ASME B107.1 | AS954E S3.8.1 |
| J5314 | Socket, 1/2" DR 7/16" 12 PT Deep | ASME B107.1 | AS954E S3.8.1 |
| J5316 | Socket, 1/2" DR 1/2" 12 PT Deep | ASME B107.1 | AS954E S3.8.1 |
| J5318 | Socket, 1/2" DR 9/16" 12 PT Deep | ASME B107.1 | AS954E S3.8.1 |
| J5320 | Socket, 1/2" DR 5/8" 12 PT Deep | ASME B107.1 | AS954E S3.8.1 |
| J5322 | Socket, 1/2" DR 11/16" 12 PT Deep | ASME B107.1 | AS954E S3.8.1 |
| J5324 | Socket, 1/2" DR 3/4" 12 PT Deep | ASME B107.1 | AS954E S3.8.1 |
| J5326 | Socket, 1/2" DR 13/16" 12 PT Deep | ASME B107.1 | AS954E S3.8.1 |
| J5328 | Socket, 1/2" DR 7/8" 12 PT Deep | ASME B107.1 | AS954E S3.8.1 |
| J5330 | Socket, 1/2" DR 15/16" 12 PT Deep | ASME B107.1 | AS954E S3.8.1 |
| J5332 | Socket, 1/2" DR 1" 12 PT Deep | ASME B107.1 | AS954E S3.8.1 |
| J5334 | Socket, 1/2" DR 1-1/16" 12 PT Deep | ASME B107.1 | AS954E S3.8.1 |
| J5336 | Socket, 1/2" DR 1-1/8" 12 PT Deep | ASME B107.1 | AS954E S3.8.1 |
| J5338 | Socket, 1/2" DR 1-3/16" 12 PT Deep | ASME B107.1 | AS954E S3.8.1 |
| J5340 | Socket, 1/2" DR 1-1/4" 12 PT Deep | ASME B107.1 | AS954E S3.8.1 |
| J5342 | Socket, 1/2" DR 1-5/16" 12 PT Deep | ASME B107.1 | AS954E S3.8.1 |
| J5344 | Socket, 1/2" DR 1-3/8" 12 PT Deep | ASME B107.1 | AS954E S3.8.1 |
| J5346 | Socket, 1/2" DR 1-7/16" 12 PT Deep | ASME B107.1 | AS954E S3.8.1 |
| J5348 | Socket, 1/2" DR 1-1/2" 12 PT Deep | ASME B107.1 | AS954E S3.8.1 |
| J2587 | Socket, Bar 17" | | |
| J2592 | Socket, Clip 1/2" DR | | |

1/2" DRIVE 15 PIECE DEEP SOCKET SET - 12 POINT

Product #: J54107

- ▶ 12 Point Deep: 3/8, 7/16, 1/2, 9/16, 5/8, 11/16, 3/4, 13/16, 7/8, 15/16, 1, 1-1/16, 1-1/8, 1-3/16, 1-1/4 Inch.
- ▶ Accessories: 17 Inch Socket Bar with 15 Socket Clips.
- ▶ Weight (lbs): 7.95



| Contents | Description | ASME Spec. | AS Spec. |
|----------|------------------------------------|-------------|---------------|
| J5312 | Socket, 1/2" DR 3/8" 12 PT Deep | ASME B107.1 | AS954E S3.8.1 |
| J5314 | Socket, 1/2" DR 7/16" 12 PT Deep | ASME B107.1 | AS954E S3.8.1 |
| J5316 | Socket, 1/2" DR 1/2" 12 PT Deep | ASME B107.1 | AS954E S3.8.1 |
| J5318 | Socket, 1/2" DR 9/16" 12 PT Deep | ASME B107.1 | AS954E S3.8.1 |
| J5320 | Socket, 1/2" DR 5/8" 12 PT Deep | ASME B107.1 | AS954E S3.8.1 |
| J5322 | Socket, 1/2" DR 11/16" 12 PT Deep | ASME B107.1 | AS954E S3.8.1 |
| J5324 | Socket, 1/2" DR 3/4" 12 PT Deep | ASME B107.1 | AS954E S3.8.1 |
| J5326 | Socket, 1/2" DR 13/16" 12 PT Deep | ASME B107.1 | AS954E S3.8.1 |
| J5328 | Socket, 1/2" DR 7/8" 12 PT Deep | ASME B107.1 | AS954E S3.8.1 |
| J5330 | Socket, 1/2" DR 15/16" 12 PT Deep | ASME B107.1 | AS954E S3.8.1 |
| J5332 | Socket, 1/2" DR 1" 12 PT Deep | ASME B107.1 | AS954E S3.8.1 |
| J5334 | Socket, 1/2" DR 1-1/16" 12 PT Deep | ASME B107.1 | AS954E S3.8.1 |
| J5336 | Socket, 1/2" DR 1-1/8" 12 PT Deep | ASME B107.1 | AS954E S3.8.1 |
| J5338 | Socket, 1/2" DR 1-3/16" 12 PT Deep | ASME B107.1 | AS954E S3.8.1 |
| J5340 | Socket, 1/2" DR 1-1/4" 12 PT Deep | ASME B107.1 | AS954E S3.8.1 |
| J2587 | Socket, Bar 17" | | |
| J2592 | Socket, Clip 1/2" DR | | |



1/2" DRIVE 19 PIECE SOCKET SET - 6 POINT

Product #: J54109

- ▶ 6 Point Standard: 3/8, 7/16, 1/2, 9/16, 5/8, 11/16, 3/4, 13/16, 7/8, 15/16, 1, 1-1/16, 1-1/8, 1-3/16, 1-1/4, 1-5/16, 1-3/8, 1-7/16, 1-1/2 Inch.
- ▶ Accessories: 17 Inch Socket Bar with 19 Socket Clips.
- ▶ Weight (lbs): 7.58



| Contents | Description | ASME Spec. |
|----------|------------------------------|-------------|
| J5412H | Socket, 1/2" DR 3/8" 6 PT | ASME B107.1 |
| J5414H | Socket, 1/2" DR 7/16" 6 PT | ASME B107.1 |
| J5416H | Socket, 1/2" DR 1/2" 6 PT | ASME B107.1 |
| J5418H | Socket, 1/2" DR 9/16" 6 PT | ASME B107.1 |
| J5420H | Socket, 1/2" DR 5/8" 6 PT | ASME B107.1 |
| J5422H | Socket, 1/2" DR 11/16" 6 PT | ASME B107.1 |
| J5424H | Socket, 1/2" DR 3/4" 6 PT | ASME B107.1 |
| J5426H | Socket, 1/2" DR 13/16" 6 PT | ASME B107.1 |
| J5428H | Socket, 1/2" DR 7/8" 6 PT | ASME B107.1 |
| J5430H | Socket, 1/2" DR 15/16" 6 PT | ASME B107.1 |
| J5432H | Socket, 1/2" DR 1" 6 PT | ASME B107.1 |
| J5434H | Socket, 1/2" DR 1-1/16" 6 PT | ASME B107.1 |
| J5436H | Socket, 1/2" DR 1-1/8" 6 PT | ASME B107.1 |
| J5438H | Socket, 1/2" DR 1-3/16" 6 PT | ASME B107.1 |
| J5440H | Socket, 1/2" DR 1-1/4" 6 PT | ASME B107.1 |
| J5442H | Socket, 1/2" DR 1-5/16" 6 PT | ASME B107.1 |
| J5444H | Socket, 1/2" DR 1-3/8" 6 PT | ASME B107.1 |
| J5446H | Socket, 1/2" DR 1-7/16" 6 PT | ASME B107.1 |
| J5448H | Socket, 1/2" DR 1-1/2" 6 PT | ASME B107.1 |
| J2587 | Socket, Bar 17" | |
| J2592 | Socket, Clip 1/2" DR | |

1/2" DRIVE 19 PIECE SOCKET SET - 12 POINT

Product #: J54113

- ▶ 12 Point Standard: 3/8, 7/16, 1/2, 9/16, 5/8, 11/16, 3/4, 13/16, 7/8, 15/16, 1, 1-1/16, 1-1/8, 1-3/16, 1-1/4, 1-5/16, 1-3/8, 1-7/16, 1-1/2 Inch.
- ▶ Accessories: 17 Inch Socket Bar with 19 Socket Clips.
- ▶ Weight (lbs): 7.25



| Contents | Description | ASME Spec. | AS Spec. |
|----------|-------------------------------|-------------|---------------|
| J5412 | Socket, 1/2" DR 3/8" 12 PT | ASME B107.1 | AS954E S3.8.1 |
| J5414 | Socket, 1/2" DR 7/16" 12 PT | ASME B107.1 | AS954E S3.8.1 |
| J5416 | Socket, 1/2" DR 1/2" 12 PT | ASME B107.1 | AS954E S3.8.1 |
| J5418 | Socket, 1/2" DR 9/16" 12 PT | ASME B107.1 | AS954E S3.8.1 |
| J5420 | Socket, 1/2" DR 5/8" 12 PT | ASME B107.1 | AS954E S3.8.1 |
| J5422 | Socket, 1/2" DR 11/16" 12 PT | ASME B107.1 | AS954E S3.8.1 |
| J5424 | Socket, 1/2" DR 3/4" 12 PT | ASME B107.1 | AS954E S3.8.1 |
| J5426 | Socket, 1/2" DR 13/16" 12 PT | ASME B107.1 | AS954E S3.8.1 |
| J5428 | Socket, 1/2" DR 7/8" 12 PT | ASME B107.1 | AS954E S3.8.1 |
| J5430 | Socket, 1/2" DR 15/16" 12 PT | ASME B107.1 | AS954E S3.8.1 |
| J5432 | Socket, 1/2" DR 1" 12 PT | ASME B107.1 | AS954E S3.8.1 |
| J5434 | Socket, 1/2" DR 1-1/16" 12 PT | ASME B107.1 | AS954E S3.8.1 |
| J5436 | Socket, 1/2" DR 1-1/8" 12 PT | ASME B107.1 | AS954E S3.8.1 |
| J5438 | Socket, 1/2" DR 1-3/16" 12 PT | ASME B107.1 | AS954E S3.8.1 |
| J5440 | Socket, 1/2" DR 1-1/4" 12 PT | ASME B107.1 | AS954E S3.8.1 |
| J5442 | Socket, 1/2" DR 1-5/16" 12 PT | ASME B107.1 | AS954E S3.8.1 |
| J5444 | Socket, 1/2" DR 1-3/8" 12 PT | ASME B107.1 | AS954E S3.8.1 |
| J5446 | Socket, 1/2" DR 1-7/16" 12 PT | ASME B107.1 | AS954E S3.8.1 |
| J5448 | Socket, 1/2" DR 1-1/2" 12 PT | ASME B107.1 | AS954E S3.8.1 |
| J2587 | Socket, Bar 17" | | |
| J2592 | Socket, Clip 1/2" DR | | |



1/2" DRIVE 15 PIECE SOCKET SET - 6 POINT

Product #: J54110

- › 6 Point Standard: 3/8, 7/16, 1/2, 9/16, 5/8, 11/16, 3/4, 13/16, 7/8, 15/16, 1, 1-1/16, 1-1/8, 1-3/16, 1-1/4 Inch.
- › Accessories: 17 Inch Socket Bar with 15 Socket Clips.
- › Weight (lbs): 4.45



| Contents | Description | ASME Spec. |
|----------|------------------------------|-------------|
| J5412H | Socket, 1/2" DR 3/8" 6 PT | ASME B107.1 |
| J5414H | Socket, 1/2" DR 7/16" 6 PT | ASME B107.1 |
| J5416H | Socket, 1/2" DR 1/2" 6 PT | ASME B107.1 |
| J5418H | Socket, 1/2" DR 9/16" 6 PT | ASME B107.1 |
| J5420H | Socket, 1/2" DR 5/8" 6 PT | ASME B107.1 |
| J5422H | Socket, 1/2" DR 11/16" 6 PT | ASME B107.1 |
| J5424H | Socket, 1/2" DR 3/4" 6 PT | ASME B107.1 |
| J5426H | Socket, 1/2" DR 13/16" 6 PT | ASME B107.1 |
| J5428H | Socket, 1/2" DR 7/8" 6 PT | ASME B107.1 |
| J5430H | Socket, 1/2" DR 15/16" 6 PT | ASME B107.1 |
| J5432H | Socket, 1/2" DR 1" 6 PT | ASME B107.1 |
| J5434H | Socket, 1/2" DR 1-1/16" 6 PT | ASME B107.1 |
| J5436H | Socket, 1/2" DR 1-1/8" 6 PT | ASME B107.1 |
| J5438H | Socket, 1/2" DR 1-3/16" 6 PT | ASME B107.1 |
| J5440H | Socket, 1/2" DR 1-1/4" 6 PT | ASME B107.1 |
| J2587 | Socket, Bar 17" | |
| J2592 | Socket, Clip 1/2" DR | |

1/2" DRIVE 23 PIECE METRIC DEEP SOCKET SET - 12 POINT

Product #: J54201

- › 12 Point Deep: 10, 11, 12, 13, 14, 15, 16, 17, 18, 19, 20, 21, 22, 23, 24, 25, 26, 27, 28, 29, 30, 31, 32 mm.
- › Accessories: (2) 17 Inch Socket Bars with 23 Socket Clips.
- › Weight (lbs): 8.95

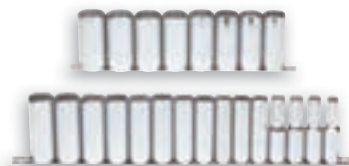

METRIC



| Contents | Description | ASME Spec. | AS Spec. |
|----------|----------------------------------|--------------|---------------|
| J5310M | Socket, 1/2" DR 10 mm 12 PT Deep | ASME B107.5M | AS954E S3.8.1 |
| J5311M | Socket, 1/2" DR 11 mm 12 PT Deep | ASME B107.5M | AS954E S3.8.1 |
| J5312M | Socket, 1/2" DR 12 mm 12 PT Deep | ASME B107.5M | AS954E S3.8.1 |
| J5313M | Socket, 1/2" DR 13 mm 12 PT Deep | ASME B107.5M | AS954E S3.8.1 |
| J5314M | Socket, 1/2" DR 14 mm 12 PT Deep | ASME B107.5M | AS954E S3.8.1 |
| J5315M | Socket, 1/2" DR 15 mm 12 PT Deep | ASME B107.5M | AS954E S3.8.1 |
| J5316M | Socket, 1/2" DR 16 mm 12 PT Deep | ASME B107.5M | AS954E S3.8.1 |
| J5317M | Socket, 1/2" DR 17 mm 12 PT Deep | ASME B107.5M | AS954E S3.8.1 |
| J5318M | Socket, 1/2" DR 18 mm 12 PT Deep | ASME B107.5M | AS954E S3.8.1 |
| J5319M | Socket, 1/2" DR 19 mm 12 PT Deep | ASME B107.5M | AS954E S3.8.1 |
| J5320M | Socket, 1/2" DR 20 mm 12 PT Deep | ASME B107.5M | AS954E S3.8.1 |
| J5321M | Socket, 1/2" DR 21 mm 12 PT Deep | ASME B107.5M | AS954E S3.8.1 |
| J5322M | Socket, 1/2" DR 22 mm 12 PT Deep | ASME B107.5M | AS954E S3.8.1 |
| J5323M | Socket, 1/2" DR 23 mm 12 PT Deep | ASME B107.5M | AS954E S3.8.1 |
| J5324M | Socket, 1/2" DR 24 mm 12 PT Deep | ASME B107.5M | AS954E S3.8.1 |
| J5325M | Socket, 1/2" DR 25 mm 12 PT Deep | ASME B107.5M | AS954E S3.8.1 |
| J5326M | Socket, 1/2" DR 26 mm 12 PT Deep | ASME B107.5M | AS954E S3.8.1 |
| J5327M | Socket, 1/2" DR 27 mm 12 PT Deep | ASME B107.5M | AS954E S3.8.1 |
| J5328M | Socket, 1/2" DR 28 mm 12 PT Deep | ASME B107.5M | AS954E S3.8.1 |
| J5329M | Socket, 1/2" DR 29 mm 12 PT Deep | ASME B107.5M | AS954E S3.8.1 |
| J5330M | Socket, 1/2" DR 30 mm 12 PT Deep | ASME B107.5M | AS954E S3.8.1 |
| J5331M | Socket, 1/2" DR 31 mm 12 PT Deep | ASME B107.5M | AS954E S3.8.1 |
| J5332M | Socket, 1/2" DR 32 mm 12 PT Deep | ASME B107.5M | AS954E S3.8.1 |
| J2586 | Socket, Bar 13" | | |
| J2587 | Socket, Bar 17" | | |
| J2592 | Socket, Clip 1/2" DR | | |



1/2" DRIVE 15 PIECE METRIC SOCKET SET - 6 POINT

METRIC



Product #: J54205

- ▶ 6 Point Standard: 10, 11, 12, 13, 14, 15, 16, 17, 18, 19, 20, 21, 22, 23, 24 mm.
- ▶ Accessories: 17 Inch Socket Bar with 15 Socket Clips.
- ▶ Weight (lbs): 3.30



| Contents | Description | ASME Spec. |
|----------|----------------------------|--------------|
| J5410MH | Socket, 1/2" DR 10 mm 6 PT | ASME B107.5M |
| J5411MH | Socket, 1/2" DR 11 mm 6 PT | ASME B107.5M |
| J5412MH | Socket, 1/2" DR 12 mm 6 PT | ASME B107.5M |
| J5413MH | Socket, 1/2" DR 13 mm 6 PT | ASME B107.5M |
| J5414MH | Socket, 1/2" DR 14 mm 6 PT | ASME B107.5M |
| J5415MH | Socket, 1/2" DR 15 mm 6 PT | ASME B107.5M |
| J5416MH | Socket, 1/2" DR 16 mm 6 PT | ASME B107.5M |
| J5417MH | Socket, 1/2" DR 17 mm 6 PT | ASME B107.5M |
| J5418MH | Socket, 1/2" DR 18 mm 6 PT | ASME B107.5M |
| J5419MH | Socket, 1/2" DR 19 mm 6 PT | ASME B107.5M |
| J5420MH | Socket, 1/2" DR 20 mm 6 PT | ASME B107.5M |
| J5421MH | Socket, 1/2" DR 21 mm 6 PT | ASME B107.5M |
| J5422MH | Socket, 1/2" DR 22 mm 6 PT | ASME B107.5M |
| J5423MH | Socket, 1/2" DR 23 mm 6 PT | ASME B107.5M |
| J5424MH | Socket, 1/2" DR 24 mm 6 PT | ASME B107.5M |
| J2587 | Socket, Bar 17" | |
| J2592 | Socket, Clip 1/2" DR | |

1/2" DRIVE 15 PIECE METRIC SOCKET SET - 12 POINT

METRIC



Product #: J54206

- ▶ 12 Point Standard: 10, 11, 12, 13, 14, 15, 16, 17, 18, 19, 20, 21, 22, 23, 24 mm.
- ▶ Accessories: 17 Inch Socket Bar with 15 Socket Clips.
- ▶ Weight (lbs): 3.08



| Contents | Description | ASME Spec. | AS Spec. |
|----------|-----------------------------|--------------|---------------|
| J5410M | Socket, 1/2" DR 10 mm 12 PT | ASME B107.5M | AS954E S3.8.1 |
| J5411M | Socket, 1/2" DR 11 mm 12 PT | ASME B107.5M | AS954E S3.8.1 |
| J5412M | Socket, 1/2" DR 12 mm 12 PT | ASME B107.5M | AS954E S3.8.1 |
| J5413M | Socket, 1/2" DR 13 mm 12 PT | ASME B107.5M | AS954E S3.8.1 |
| J5414M | Socket, 1/2" DR 14 mm 12 PT | ASME B107.5M | AS954E S3.8.1 |
| J5415M | Socket, 1/2" DR 15 mm 12 PT | ASME B107.5M | AS954E S3.8.1 |
| J5416M | Socket, 1/2" DR 16 mm 12 PT | ASME B107.5M | AS954E S3.8.1 |
| J5417M | Socket, 1/2" DR 17 mm 12 PT | ASME B107.5M | AS954E S3.8.1 |
| J5418M | Socket, 1/2" DR 18 mm 12 PT | ASME B107.5M | AS954E S3.8.1 |
| J5419M | Socket, 1/2" DR 19 mm 12 PT | ASME B107.5M | AS954E S3.8.1 |
| J5420M | Socket, 1/2" DR 20 mm 12 PT | ASME B107.5M | AS954E S3.8.1 |
| J5421M | Socket, 1/2" DR 21 mm 12 PT | ASME B107.5M | AS954E S3.8.1 |
| J5422M | Socket, 1/2" DR 22 mm 12 PT | ASME B107.5M | AS954E S3.8.1 |
| J5423M | Socket, 1/2" DR 23 mm 12 PT | ASME B107.5M | AS954E S3.8.1 |
| J5424M | Socket, 1/2" DR 24 mm 12 PT | ASME B107.5M | AS954E S3.8.1 |
| J2587 | Socket, Bar 17" | | |
| J2592 | Socket, Clip 1/2" DR | | |





1/2" DRIVE 15 PIECE METRIC DEEP SOCKET SET - 12 POINT

METRIC



Product #: J54207

- › 12 Point Deep: 10, 11, 12, 13, 14, 15, 16, 17, 18, 19, 20, 21, 22, 23, 24 mm.
- › Accessories: 17 Inch Socket Bar with 15 Socket Clips.
- › Weight (lbs): 6.04



| Contents | Description | ASME Spec. | AS Spec. |
|----------|----------------------------------|--------------|---------------|
| J5310M | Socket, 1/2" DR 10 mm 12 PT Deep | ASME B107.5M | AS954E S3.8.1 |
| J5311M | Socket, 1/2" DR 11 mm 12 PT Deep | ASME B107.5M | AS954E S3.8.1 |
| J5312M | Socket, 1/2" DR 12 mm 12 PT Deep | ASME B107.5M | AS954E S3.8.1 |
| J5313M | Socket, 1/2" DR 13 mm 12 PT Deep | ASME B107.5M | AS954E S3.8.1 |
| J5314M | Socket, 1/2" DR 14 mm 12 PT Deep | ASME B107.5M | AS954E S3.8.1 |
| J5315M | Socket, 1/2" DR 15 mm 12 PT Deep | ASME B107.5M | AS954E S3.8.1 |
| J5316M | Socket, 1/2" DR 16 mm 12 PT Deep | ASME B107.5M | AS954E S3.8.1 |
| J5317M | Socket, 1/2" DR 17 mm 12 PT Deep | ASME B107.5M | AS954E S3.8.1 |
| J5318M | Socket, 1/2" DR 18 mm 12 PT Deep | ASME B107.5M | AS954E S3.8.1 |
| J5319M | Socket, 1/2" DR 19 mm 12 PT Deep | ASME B107.5M | AS954E S3.8.1 |
| J5320M | Socket, 1/2" DR 20 mm 12 PT Deep | ASME B107.5M | AS954E S3.8.1 |
| J5321M | Socket, 1/2" DR 21 mm 12 PT Deep | ASME B107.5M | AS954E S3.8.1 |
| J5322M | Socket, 1/2" DR 22 mm 12 PT Deep | ASME B107.5M | AS954E S3.8.1 |
| J5323M | Socket, 1/2" DR 23 mm 12 PT Deep | ASME B107.5M | AS954E S3.8.1 |
| J5324M | Socket, 1/2" DR 24 mm 12 PT Deep | ASME B107.5M | AS954E S3.8.1 |
| J2587 | Socket, Bar 17" | | |
| J2592 | Socket, Clip 1/2" DR | | |

1/2" DRIVE 15 PIECE SOCKET SET - 12 POINT

Product #: J54114



- › 12 Point Standard: 3/8, 7/16, 1/2, 9/16, 5/8, 11/16, 3/4, 13/16, 7/8, 15/16, 1, 1-1/16, 1-1/8, 1-3/16, 1-1/4 Inch.
- › Accessories: 17 Inch Socket Bar with 15 Socket Clips.
- › Weight (lbs): 4.26



| Contents | Description | ASME Spec. | AS Spec. |
|----------|-------------------------------|-------------|---------------|
| J5412 | Socket, 1/2" DR 3/8" 12 PT | ASME B107.1 | AS954E S3.8.1 |
| J5414 | Socket, 1/2" DR 7/16" 12 PT | ASME B107.1 | AS954E S3.8.1 |
| J5416 | Socket, 1/2" DR 1/2" 12 PT | ASME B107.1 | AS954E S3.8.1 |
| J5418 | Socket, 1/2" DR 9/16" 12 PT | ASME B107.1 | AS954E S3.8.1 |
| J5420 | Socket, 1/2" DR 5/8" 12 PT | ASME B107.1 | AS954E S3.8.1 |
| J5422 | Socket, 1/2" DR 11/16" 12 PT | ASME B107.1 | AS954E S3.8.1 |
| J5424 | Socket, 1/2" DR 3/4" 12 PT | ASME B107.1 | AS954E S3.8.1 |
| J5426 | Socket, 1/2" DR 13/16" 12 PT | ASME B107.1 | AS954E S3.8.1 |
| J5428 | Socket, 1/2" DR 7/8" 12 PT | ASME B107.1 | AS954E S3.8.1 |
| J5430 | Socket, 1/2" DR 15/16" 12 PT | ASME B107.1 | AS954E S3.8.1 |
| J5432 | Socket, 1/2" DR 1" 12 PT | ASME B107.1 | AS954E S3.8.1 |
| J5434 | Socket, 1/2" DR 1-1/16" 12 PT | ASME B107.1 | AS954E S3.8.1 |
| J5436 | Socket, 1/2" DR 1-1/8" 12 PT | ASME B107.1 | AS954E S3.8.1 |
| J5438 | Socket, 1/2" DR 1-3/16" 12 PT | ASME B107.1 | AS954E S3.8.1 |
| J5440 | Socket, 1/2" DR 1-1/4" 12 PT | ASME B107.1 | AS954E S3.8.1 |
| J2587 | Socket, Bar 17" | | |
| J2592 | Socket, Clip 1/2" DR | | |





1/2" DRIVE 11 PIECE DEEP SOCKET SET - 12 POINT

Product #: J54104

- ▶ 12 Point Deep: 1/2, 9/16, 5/8, 11/16, 3/4, 13/16, 7/8, 15/16, 1, 1-1/16, 1-1/8.
- ▶ Accessories: 17 Inch Socket Bar and Socket Clips.
- ▶ Weight (lbs): 5.68



| Contents | Description | ASME Spec. | AS Spec. |
|----------|------------------------------------|-------------|---------------|
| J5316 | Socket, 1/2" DR 1/2" 12 PT Deep | ASME B107.1 | AS954E S3.8.1 |
| J5318 | Socket, 1/2" DR 9/16" 12 PT Deep | ASME B107.1 | AS954E S3.8.1 |
| J5320 | Socket, 1/2" DR 5/8" 12 PT Deep | ASME B107.1 | AS954E S3.8.1 |
| J5322 | Socket, 1/2" DR 11/16" 12 PT Deep | ASME B107.1 | AS954E S3.8.1 |
| J5324 | Socket, 1/2" DR 3/4" 12 PT Deep | ASME B107.1 | AS954E S3.8.1 |
| J5326 | Socket, 1/2" DR 13/16" 12 PT Deep | ASME B107.1 | AS954E S3.8.1 |
| J5328 | Socket, 1/2" DR 7/8" 12 PT Deep | ASME B107.1 | AS954E S3.8.1 |
| J5330 | Socket, 1/2" DR 15/16" 12 PT Deep | ASME B107.1 | AS954E S3.8.1 |
| J5332 | Socket, 1/2" DR 1" 12 PT Deep | ASME B107.1 | AS954E S3.8.1 |
| J5334 | Socket, 1/2" DR 1-1/16" 12 PT Deep | ASME B107.1 | AS954E S3.8.1 |
| J5336 | Socket, 1/2" DR 1-1/8" 12 PT Deep | ASME B107.1 | AS954E S3.8.1 |
| J2587 | Socket, Bar 17" | | |
| J2592 | Socket, Clip 1/2" DR | | |

1/2" DRIVE 15 PIECE BLACK OXIDE SOCKET SET - 12 POINT

Product #: J54302

- ▶ 12 Point Standard: 3/8, 7/16, 1/2, 9/16, 5/8, 11/16, 3/4, 13/16, 7/8, 15/16, 1, 1-1/16, 1-1/8, 1-3/16, 1-1/4 Inch.
- ▶ Accessories: 17 Inch Socket Bar with 15 Socket Clips.
- ▶ Weight (lbs): 4.47



| Contents | Description | ASME Spec. | AS Spec. |
|----------|---|-------------|---------------|
| J5412B | Socket, 1/2" DR 3/8" 12 PT Black Oxide | ASME B107.1 | AS954E S3.8.1 |
| J5414B | Socket, 1/2" DR 7/16" 12 PT Black Oxide | ASME B107.1 | AS954E S3.8.1 |
| J5416B | Socket, 1/2" DR 1/2" 12 PT Black Oxide | ASME B107.1 | AS954E S3.8.1 |
| J5418B | Socket, 1/2" DR 9/16" 12 PT Black Oxide | ASME B107.1 | AS954E S3.8.1 |
| J5420B | Socket, 1/2" DR 5/8" 12 PT Black Oxide | ASME B107.1 | AS954E S3.8.1 |
| J5422B | Socket, 1/2" DR 11/16" 12 PT Black Oxide | ASME B107.1 | AS954E S3.8.1 |
| J5424B | Socket, 1/2" DR 3/4" 12 PT Black Oxide | ASME B107.1 | AS954E S3.8.1 |
| J5426B | Socket, 1/2" DR 13/16" 12 PT Black Oxide | ASME B107.1 | AS954E S3.8.1 |
| J5428B | Socket, 1/2" DR 7/8" 12 PT Black Oxide | ASME B107.1 | AS954E S3.8.1 |
| J5430B | Socket, 1/2" DR 15/16" 12 PT Black Oxide | ASME B107.1 | AS954E S3.8.1 |
| J5432B | Socket, 1/2" DR 1" 12 PT Black Oxide | ASME B107.1 | AS954E S3.8.1 |
| J5434B | Socket, 1/2" DR 1-1/16" 12 PT Black Oxide | ASME B107.1 | AS954E S3.8.1 |
| J5436B | Socket, 1/2" DR 1-1/8" 12 PT Black Oxide | ASME B107.1 | AS954E S3.8.1 |
| J5438B | Socket, 1/2" DR 1-3/16" 12 PT Black Oxide | ASME B107.1 | AS954E S3.8.1 |
| J5440B | Socket, 1/2" DR 1-1/4" 12 PT Black Oxide | ASME B107.1 | AS954E S3.8.1 |
| J2587 | Socket, Bar 17" | | |
| J2592 | Socket, Clip 1/2" DR | | |



1/2" DRIVE 10 PIECE METRIC HEX BIT SET

METRIC



Product #: **J5441-MA**



- › Sockets: 6, 8, 10, 12, 13, 14, 15, 17, 18, 19 mm.
- › Accessories: 13 Inch Socket Bar, 10 Socket Clips.
- › Weight (lbs): 5.40

| Contents | Description |
|-----------|-------------------------------|
| J5441-6M | Socket, Hex Bit 1/2" DR 6 mm |
| J5441-8M | Socket, Hex Bit 1/2" DR 8 mm |
| J5441-10M | Socket, Hex Bit 1/2" DR 10 mm |
| J5441-12M | Socket, Hex Bit 1/2" DR 12 mm |
| J5441-13M | Socket, Hex Bit 1/2" DR 13 mm |
| J5441-14M | Socket, Hex Bit 1/2" DR 14 mm |
| J5441-15M | Socket, Hex Bit 1/2" DR 15 mm |
| J5441-17M | Socket, Hex Bit 1/2" DR 17 mm |
| J5441-18M | Socket, Hex Bit 1/2" DR 18 mm |
| J5441-19M | Socket, Hex Bit 1/2" DR 19 mm |
| J2586 | Socket, Bar 13" |
| J2592 | Socket, Clip 1/2" DR |

1/2" DRIVE 7 PIECE HEX BIT SET

Product #: **J5441-7**



- › Sockets: 1/4, 5/16, 3/8, 7/16, 1/2, 9/16, 5/8 Inch.
- › Accessories: 9 Inch Socket Bar with 7 Socket Clips.
- › Weight (lbs): 2.93

| Contents | Description |
|-----------|-------------------------------|
| J54411/4 | Socket, Hex Bit 1/2" DR 1/4" |
| J54415/16 | Socket, Hex Bit 1/2" DR 5/16" |
| J54413/8 | Socket, Hex Bit 1/2" DR 3/8" |
| J54417/16 | Socket, Hex Bit 1/2" DR 7/16" |
| J54411/2 | Socket, Hex Bit 1/2" DR 1/2" |
| J54419/16 | Socket, Hex Bit 1/2" DR 9/16" |
| J54415/8 | Socket, Hex Bit 1/2" DR 5/8" |
| J2585 | Socket, Bar 9" |
| J2592 | Socket, Clip 1/2" DR |



1/2" DRIVE 6 PIECE METRIC HEX BIT SET

METRIC



Product #: J5441-SM

- › Sockets: 6, 8, 10, 12, 14, 17 mm.
- › Accessories: 9 Inch Socket Bar with 6 Socket Clips.
- › Weight (lbs): 2.55

| Contents | Description |
|-----------|-------------------------------|
| J5441-6M | Socket, Hex Bit 1/2" DR 6 mm |
| J5441-8M | Socket, Hex Bit 1/2" DR 8 mm |
| J5441-10M | Socket, Hex Bit 1/2" DR 10 mm |
| J5441-12M | Socket, Hex Bit 1/2" DR 12 mm |
| J5441-14M | Socket, Hex Bit 1/2" DR 14 mm |
| J5441-17M | Socket, Hex Bit 1/2" DR 17 mm |
| J2585 | Socket, Bar 9" |
| J2592 | Socket, Clip 1/2" DR |



1/2" DRIVE 6 PIECE EXTRA-LONG HEX BIT SET

Product #: J5441-6XL

- › Sockets: 1/4, 5/16, 3/8, 1/2, 9/16, 5/8 Inch.
- › Accessories: 9 Inch Socket Bar with 6 Socket Clips.
- › Weight (lbs): 3.59

| Contents | Description |
|-------------|--|
| J54411/4XL | Socket, Hex Bit 1/2" DR 1/4" Extra-Long |
| J54415/16XL | Socket, Hex Bit 1/2" DR 5/16" Extra-Long |
| J54418XL | Socket, Hex Bit 1/2" DR 3/8" Extra-Long |
| J54411/2XL | Socket, Hex Bit 1/2" DR 1/2" Extra-Long |
| J54419/16XL | Socket, Hex Bit 1/2" DR 9/16" Extra-Long |
| J54415/8XL | Socket, Hex Bit 1/2" DR 5/8" Extra-Long |
| J2585 | Socket, Bar 9" |
| J2592 | Socket, Clip 1/2" DR |





1/2" DRIVE 39 PIECE FLARE NUT CROWFOOT WRENCH SET

Product #: J53000CLFN



- › (39) Crowfoot Wrenches including 15 Crowfoot Flare Nut Wrenches.
- › Crowfoot Open End: 15/16, 1, 1-1/16, 1-1/8, 1-3/16, 1-1/4, 1-5/16, 1-3/8, 1-7/16, 1-1/2, 1-9/16, 1-5/8, 1-11/16, 1-3/4, 1-13/16, 1-7/8, 2, 2-1/8, 2-1/4, 2-3/8, 2-7/16, 2-1/2 Inch.
- › Flare Nut Crowfoot: 1-1/8, 1-3/16, 1-1/4, 1-5/16, 1-3/8, 1-7/8, 1-1/2, 1-9/16, 1-5/8, 1-11/16, 1-3/4, 1-13/16, 1-7/8, 1-15/16, 2 Inch.
- › Accessories: 5 and 10 Inch Locking Extensions.
- › Weight (lbs): 23.80



| Contents | Description | ASME Spec. |
|----------|---|---------------|
| J5330CF | Wrench, Crowfoot Open End 1/2" DR 15/16" | ASME B107.21 |
| J5332CF | Wrench, Crowfoot Open End 1/2" DR 1" | ASME B107.21 |
| J5334CF | Wrench, Crowfoot Open End 1/2" DR 1-1/16" | ASME B107.21 |
| J5336CF | Wrench, Crowfoot Open End 1/2" DR 1-1/8" | ASME B107.21 |
| J5338CF | Wrench, Crowfoot Open End 1/2" DR 1-3/16" | ASME B107.21 |
| J5340CF | Wrench, Crowfoot Open End 1/2" DR 1-1/4" | ASME B107.21 |
| J5342CF | Wrench, Crowfoot Open End 1/2" DR 1-5/16" | ASME B107.21 |
| J5344CF | Wrench, Crowfoot Open End 1/2" DR 1-3/8" | ASME B107.21 |
| J5346CF | Wrench, Crowfoot Open End 1/2" DR 1-7/16" | ASME B107.21 |
| J5348CF | Wrench, Crowfoot Open End 1/2" DR 1-1/2" | ASME B107.21 |
| J5350CF | Wrench, Crowfoot Open End 1/2" DR 1-9/16" | ASME B107.21 |
| J5352CF | Wrench, Crowfoot Open End 1/2" DR 1-5/8" | ASME B107.21 |
| J5354CF | Wrench, Crowfoot Open End 1/2" DR 1-11/16" | ASME B107.21 |
| J5356CF | Wrench, Crowfoot Open End 1/2" DR 1-3/4" | ASME B107.21 |
| J5358CF | Wrench, Crowfoot Open End 1/2" DR 1-13/16" | ASME B107.21 |
| J5360CF | Wrench, Crowfoot Open End 1/2" DR 1-7/8" | ASME B107.21 |
| J5364CF | Wrench, Crowfoot Open End 1/2" DR 2" | ASME B107.21 |
| J5368CF | Wrench, Crowfoot Open End 1/2" DR 2-1/8" | ASME B107.21 |
| J5372CF | Wrench, Crowfoot Open End 1/2" DR 2-1/4" | ASME B107.21 |
| J5376CF | Wrench, Crowfoot Open End 1/2" DR 2-3/8" | ASME B107.21 |
| J5378CF | Wrench, Crowfoot Open End 1/2" DR 2-7/16" | ASME B107.21 |
| J5380CF | Wrench, Crowfoot Open End 1/2" DR 2-1/2" | ASME B107.21 |
| J5336FL | Wrench, Crowfoot Flare Nut 1/2" DR 1-1/8" | ASME B107.21 |
| J5338FL | Wrench, Crowfoot Flare Nut 1/2" DR 1-3/16" | ASME B107.21 |
| J5340FL | Wrench, Crowfoot Flare Nut 1/2" DR 1-1/4" | ASME B107.21 |
| J5342FL | Wrench, Crowfoot Flare Nut 1/2" DR 1-5/16" | ASME B107.21 |
| J5344FL | Wrench, Crowfoot Flare Nut 1/2" DR 1-3/8" | ASME B107.21 |
| J5346FL | Wrench, Crowfoot Flare Nut 1/2" DR 1-7/16" | ASME B107.21 |
| J5348FL | Wrench, Crowfoot Flare Nut 1/2" DR 1-1/2" | ASME B107.21 |
| J5350FL | Wrench, Crowfoot Flare Nut 1/2" DR 1-9/16" | ASME B107.21 |
| J5352FL | Wrench, Crowfoot Flare Nut 1/2" DR 1-5/8" | ASME B107.21 |
| J5354FL | Wrench, Crowfoot Flare Nut 1/2" DR 1-11/16" | ASME B107.21 |
| J5356FL | Wrench, Crowfoot Flare Nut 1/2" DR 1-3/4" | ASME B107.21 |
| J5358FL | Wrench, Crowfoot Flare Nut 1/2" DR 1-13/16" | ASME B107.21 |
| J5360FL | Wrench, Crowfoot Flare Nut 1/2" DR 1-7/8" | ASME B107.21 |
| J5362FL | Wrench, Crowfoot Flare Nut 1/2" DR 1-15/16" | ASME B107.21 |
| J5364FL | Wrench, Crowfoot Flare Nut 1/2" DR 2" | ASME B107.21 |
| J5461L | Extension, 1/2 DR 5" Locking | ASME B107.500 |
| J5463L | Extension, 1/2 DR 10" Locking | ASME B107.500 |





1/2" DRIVE 22 PIECE CROWFOOT WRENCH SET

Product #: J5300CF

- › Crowfoot Open End: 15/16, 1, 1-1/16, 1-1/8, 1-3/16, 1-1/4, 1-5/16, 1-3/8, 1-7/16, 1-1/2, 1-9/16, 1-5/8, 1-11/16, 1-3/4, 1-13/16, 1-7/8, 2, 2-1/8, 2-3/8, 2-7/16, 2-1/2 Inch.
- › Weight (lbs): 16.35



| Contents | Description | ASME Spec. |
|----------|--|--------------|
| J5330CF | Wrench, Crowfoot Open End 1/2" DR 15/16" | ASME B107.21 |
| J5332CF | Wrench, Crowfoot Open End 1/2" DR 1" | ASME B107.21 |
| J5334CF | Wrench, Crowfoot Open End 1/2" DR 1-1/16" | ASME B107.21 |
| J5336CF | Wrench, Crowfoot Open End 1/2" DR 1-1/8" | ASME B107.21 |
| J5338CF | Wrench, Crowfoot Open End 1/2" DR 1-3/16" | ASME B107.21 |
| J5340CF | Wrench, Crowfoot Open End 1/2" DR 1-1/4" | ASME B107.21 |
| J5342CF | Wrench, Crowfoot Open End 1/2" DR 1-5/16" | ASME B107.21 |
| J5344CF | Wrench, Crowfoot Open End 1/2" DR 1-3/8" | ASME B107.21 |
| J5346CF | Wrench, Crowfoot Open End 1/2" DR 1-7/16" | ASME B107.21 |
| J5348CF | Wrench, Crowfoot Open End 1/2" DR 1-1/2" | ASME B107.21 |
| J5350CF | Wrench, Crowfoot Open End 1/2" DR 1-9/16" | ASME B107.21 |
| J5352CF | Wrench, Crowfoot Open End 1/2" DR 1-5/8" | ASME B107.21 |
| J5354CF | Wrench, Crowfoot Open End 1/2" DR 1-11/16" | ASME B107.21 |
| J5356CF | Wrench, Crowfoot Open End 1/2" DR 1-3/4" | ASME B107.21 |
| J5358CF | Wrench, Crowfoot Open End 1/2" DR 1-13/16" | ASME B107.21 |
| J5360CF | Wrench, Crowfoot Open End 1/2" DR 1-7/8" | ASME B107.21 |
| J5364CF | Wrench, Crowfoot Open End 1/2" DR 2" | ASME B107.21 |
| J5368CF | Wrench, Crowfoot Open End 1/2" DR 2-1/8" | ASME B107.21 |
| J5372CF | Wrench, Crowfoot Open End 1/2" DR 2-1/4" | ASME B107.21 |
| J5376CF | Wrench, Crowfoot Open End 1/2" DR 2-3/8" | ASME B107.21 |
| J5378CF | Wrench, Crowfoot Open End 1/2" DR 2-7/16" | ASME B107.21 |
| J5380CF | Wrench, Crowfoot Open End 1/2" DR 2-1/2" | ASME B107.21 |

1/2" DRIVE 15 PIECE CROWFOOT WRENCH SET

Product #: J53001CF

- › Crowfoot Open End: 1-1/16, 1-1/8, 1-3/16, 1-1/4, 1-5/16, 1-3/8, 1-7/16, 1-1/2, 1-9/16, 1-5/8, 1-11/16, 1-3/4, 1-13/16, 1-7/8, 2 Inch.
- › Accessories: Socket Clips and Bar, Full Polish Finish.
- › Weight (lbs): 9.88



| Contents | Description | ASME Spec. |
|----------|--|--------------|
| J5334CF | Wrench, Crowfoot Open End 1/2" DR 1-1/16" | ASME B107.21 |
| J5336CF | Wrench, Crowfoot Open End 1/2" DR 1-1/8" | ASME B107.21 |
| J5338CF | Wrench, Crowfoot Open End 1/2" DR 1-3/16" | ASME B107.21 |
| J5340CF | Wrench, Crowfoot Open End 1/2" DR 1-1/4" | ASME B107.21 |
| J5342CF | Wrench, Crowfoot Open End 1/2" DR 1-5/16" | ASME B107.21 |
| J5344CF | Wrench, Crowfoot Open End 1/2" DR 1-3/8" | ASME B107.21 |
| J5346CF | Wrench, Crowfoot Open End 1/2" DR 1-7/16" | ASME B107.21 |
| J5348CF | Wrench, Crowfoot Open End 1/2" DR 1-1/2" | ASME B107.21 |
| J5350CF | Wrench, Crowfoot Open End 1/2" DR 1-9/16" | ASME B107.21 |
| J5352CF | Wrench, Crowfoot Open End 1/2" DR 1-5/8" | ASME B107.21 |
| J5354CF | Wrench, Crowfoot Open End 1/2" DR 1-11/16" | ASME B107.21 |
| J5356CF | Wrench, Crowfoot Open End 1/2" DR 1-3/4" | ASME B107.21 |
| J5358CF | Wrench, Crowfoot Open End 1/2" DR 1-13/16" | ASME B107.21 |
| J5360CF | Wrench, Crowfoot Open End 1/2" DR 1-7/8" | ASME B107.21 |
| J5364CF | Wrench, Crowfoot Open End 1/2" DR 2" | ASME B107.21 |



1/2" DRIVE 15 PIECE CROWFOOT FLARE NUT WRENCH SET

Product #: J53000CFFN



- › Crowfoot: 1-1/8, 1-3/16, 1-1/4, 1-5/16, 1-3/8, 1-7/16, 1-1/2, 1-9/16, 1-5/8, 1-11/16, 1-3/4, 1-13/16, 1-7/8, 1-15/16, 2 Inch.
- › Accessories: Socket Clips and Bar, Full Polish Finish.
- › Weight (lbs): 5.86



| Contents | Description | ASME Spec. |
|----------|---|--------------|
| J5336FL | Wrench, Crowfoot Flare Nut 1/2" DR 1-1/8" | ASME B107.21 |
| J5338FL | Wrench, Crowfoot Flare Nut 1/2" DR 1-3/16" | ASME B107.21 |
| J5340FL | Wrench, Crowfoot Flare Nut 1/2" DR 1-1/4" | ASME B107.21 |
| J5342FL | Wrench, Crowfoot Flare Nut 1/2" DR 1-5/16" | ASME B107.21 |
| J5344FL | Wrench, Crowfoot Flare Nut 1/2" DR 1-3/8" | ASME B107.21 |
| J5346FL | Wrench, Crowfoot Flare Nut 1/2" DR 1-7/16" | ASME B107.21 |
| J5348FL | Wrench, Crowfoot Flare Nut 1/2" DR 1-1/2" | ASME B107.21 |
| J5350FL | Wrench, Crowfoot Flare Nut 1/2" DR 1-9/16" | ASME B107.21 |
| J5352FL | Wrench, Crowfoot Flare Nut 1/2" DR 1-5/8" | ASME B107.21 |
| J5354FL | Wrench, Crowfoot Flare Nut 1/2" DR 1-11/16" | ASME B107.21 |
| J5356FL | Wrench, Crowfoot Flare Nut 1/2" DR 1-3/4" | ASME B107.21 |
| J5358FL | Wrench, Crowfoot Flare Nut 1/2" DR 1-13/16" | ASME B107.21 |
| J5360FL | Wrench, Crowfoot Flare Nut 1/2" DR 1-7/8" | ASME B107.21 |
| J5362FL | Wrench, Crowfoot Flare Nut 1/2" DR 1-15/16" | ASME B107.21 |
| J5364FL | Wrench, Crowfoot Flare Nut 1/2" DR 2" | ASME B107.21 |





1/2" DRIVE STANDARD LENGTH PREMIUM PEAR HEAD RATCHETS



- ▶ Small pear head design for access in tight, hard to reach work areas.
- ▶ 45-tooth gear provides balance between 8° articulation angle and high torque carrying capacity.
- ▶ Sealed design helps prevent debris from entering the ratchet mechanism reducing wear. Also, helps to keep lubrication contained within the components. Patent pending design.
- ▶ Low profile reversing lever design for quick, one-hand operation.
- ▶ Contoured, ergonomically-designed handle for comfort. Knurled bands allow for increased grip and slip resistance.
- ▶ Double nickel chrome plated for enhanced corrosion protection or black oxide finish.
- ▶ Field repairable.



| Product # | Drive Size (in) | Finish | Overall Length (in) | Weight (lbs) | Repair Kit |
|------------------|-----------------|-------------|---------------------|--------------|------------|
| J5449XL | 1/2 | Full Polish | 10-1/2 | 1.72 | J5449XLARK |
| J5449XLBL | 1/2 | Black Oxide | 10-1/2 | 1.72 | J5449XLARK |

ASME B107.500

1/2" DRIVE QUICK RELEASE PREMIUM PEAR HEAD RATCHETS



- ▶ Small, pear head design for access in tight, hard to reach work areas.
- ▶ 45-tooth gear, 8° swing articulation.
- ▶ Low profile quick release button for access in restricted areas.
- ▶ Low profile reversing lever design for quick, one-hand operation.
- ▶ Patented sealed head design helps prevent debris from entering the ratchet mechanism reducing wear. Also, helps to keep lubrication contained within the components.
- ▶ Contoured, ergonomically-designed handle for comfort. Knurled bands allow for increased grip and slip resistance.
- ▶ Full polished handle, easy to clean.
- ▶ Double nickel chrome plated for enhanced corrosion protection meeting aerospace requirements.
- ▶ Also available in black oxide finish.
- ▶ Field repairable.



| Product # | Drive Size (in) | Finish | Overall Length (in) | Weight (lbs) | Repair Kit |
|--------------------|-----------------|-------------|---------------------|--------------|-------------|
| J5449XLQR | 1/2 | Full Polish | 10-1/2 | 1.72 | J5449XLQARK |
| J5449XLQRBL | 1/2 | Black Oxide | 10-1/2 | 1.72 | J5449XLQARK |
| J5450XLQR | 1/2 | Full Polish | 15 | 2.18 | J5449XLQARK |
| J5450XLQRBL | 1/2 | Black Oxide | 15 | 2.18 | J5449XLQARK |

ASME B107.10

1/2" DRIVE LONG HANDLE PREMIUM PEAR HEAD RATCHETS



- ▶ Small pear head design for access in tight, hard to reach work areas.
- ▶ 45-tooth gear provides balance between 8° articulation angle and high torque carrying capacity.
- ▶ Sealed design helps prevent debris from entering the ratchet mechanism reducing wear. Also, helps to keep lubrication contained within the components. Patent pending design.
- ▶ Low profile reversing lever design for quick, one-hand operation.
- ▶ Contoured, ergonomically-designed handle for comfort. Knurled bands allow for increased grip and slip resistance.
- ▶ Double nickel chrome plated for enhanced corrosion protection or black oxide finish.
- ▶ Field repairable.



| Product # | Drive Size (in) | Finish | Overall Length (in) | Weight (lbs) | Repair Kit |
|------------------|-----------------|-------------|---------------------|--------------|------------|
| J5450XL | 1/2 | Full Polish | 15 | 2.18 | J5449XLARK |
| J5450XLBL | 1/2 | Black Oxide | 15 | 2.18 | J5449XLARK |

ASME B107.500

1/2" DRIVE OVERSIZED LEVER CLASSIC PEAR HEAD RATCHET



- › Oversized reverse lever for easy reversing while wearing work gloves.
- › Reversing lever designed for quick one-hand operation.
- › Ideal ratchet for lineman operations.
- › Unique 24-tooth gear design provides 15° ratcheting angle while maximizing ultimate torque.

| Product # | Drive Size (in) | Finish | Overall Length (in) | Weight (lbs) | Repair Kit |
|---|-----------------|-------------|---------------------|--------------|------------|
| J5449UT | 1/2 | Full Polish | 10 | 1.50 | J5449UTRK |
|  ASME B107.500 | | | | | |

1/2" DRIVE STANDARD LENGTH CLASSIC PEAR HEAD RATCHETS



- › Robust 24-tooth design with 15° arc swing.
- › Alloy steel drive gear for strength and durability.
- › Low profile head for access in constricted areas.
- › Reversing lever design for quick, one-hand operation.
- › Knurled slip-resistant grip.

| Product # | Drive Size (in) | Finish | Overall Length (in) | Weight (lbs) | Repair Kit |
|---|-----------------|-------------|---------------------|--------------|------------|
| J5449 | 1/2 | Full Polish | 10 | 1.57 | J5449RK |
| J5449BL | 1/2 | Black Oxide | 10 | 1.74 | J5449RK |
|  ASME B107.500 | | | | | |

1/2" DRIVE LONG HANDLE CLASSIC PEAR HEAD RATCHETS



- › Robust 24-tooth design with 15° arc swing.
- › Alloy steel drive gear for strength and durability.
- › Low profile head for access in constricted areas.
- › Reversing lever design for quick, one-hand operation.
- › Knurled slip-resistant grip.
- › Field repairable.

| Product # | Drive Size (in) | Finish | Overall Length (in) | Weight (lbs) | Repair Kit |
|---|-----------------|-------------|---------------------|--------------|------------|
| J5450 | 1/2 | Full Polish | 16 | 2.03 | J5449RK |
| J5450BL | 1/2 | Black Oxide | 16 | 2.03 | J5449RK |
|  ASME B107.500 | | | | | |



1/2" DRIVE LONG HANDLE FEMALE DRIVE RATCHET

- › Robust 24-tooth design with 15° arc swing.
- › Alloy steel drive gear for strength and durability.
- › Low profile head for access in constricted areas.
- › Reversing lever design for quick, one-hand operation.
- › Knurled slip-resistant grip.
- › Made of heat-treated alloy steel.



| Product # | Drive Size (in) | Finish | Overall Length (in) | Weight (lbs) | Repair Kit |
|----------------|-----------------|-------------|---------------------|--------------|------------|
| J5450FW | 1/2 | Full Polish | 16 | 1.82 | J5450FWRK |



ASME B107.500

1/2" DRIVE STANDARD LENGTH ROUND HEAD RATCHETS

- › Small head design and tight swing allow fastener to access tight areas.
- › Full polish or black oxide finish with knurled grip for strong slip-resistant grip.
- › 5° ratcheting angle.



| Product # | Drive Size (in) | Finish | Overall Length (in) | Weight (lbs) | Repair Kit |
|-----------------|-----------------|-------------|---------------------|--------------|------------|
| J5452F | 1/2 | Full Polish | 9-3/8 | 1.12 | J5452FRK |
| J5452FBL | 1/2 | Black Oxide | 9-3/8 | 1.12 | J5452FRK |

ASME B107.500

1/2" DRIVE LONG HANDLE ROUND HEAD RATCHET

- › Round head ratchet mechanism allows for a compact head.
- › 72-tooth = 5° swing arc.
- › Small head design and tight swing arc allow for fastener access in tight areas.
- › Full polish shaft with knurled grip for strong slip-resistant grip.



| Product # | Drive Size (in) | Finish | Overall Length (in) | Weight (lbs) | Repair Kit |
|---------------|-----------------|-------------|---------------------|--------------|------------|
| J5454F | 1/2 | Full Polish | 15 | 1.65 | J5452FRK |

1/2" DRIVE FLEX-HEAD RATCHET

- › 180° flex.
- › 72-tooth gear.
- › 5° ratcheting angle.
- › Small head design and tight swing arc allow fastener to access tight area.
- › Full polish shaft with knurled grip allows for a strong slip-resistant grip.



| Product # | Drive Size (in) | Finish | Overall Length (in) | Weight (lbs) | Repair Kit |
|---------------|-----------------|-------------|---------------------|--------------|------------|
| J5457F | 1/2 | Full Polish | 17-3/32 | 1.53 | J5452FRK |

ASME B107.500

1/2" DRIVE SCAFFOLDING RATCHET

- › The scaffold ratchet is designed for working with scaffolding and other construction applications.
- › Socket retained with through hole and pin for safety.
- › Hammer tip reduces vibration and protects fasteners against distortion.
- › Hole in ratchet handle to be used with tether strap.

| Product # | Drive Size (in) | Finish | Overall Length (in) | Weight (lbs) |
|----------------|-----------------|-------------|---------------------|--------------|
| J5449SC | 1/2 | Full Polish | 10 | 2.01 |



1/2" DRIVE SPUD HANDLE RATCHET

- › Tapered handle for aligning bolt holes.
- › Spring-loaded pellet in male drive plug.
- › Black oxide finish.

| Product # | Drive Size (in) | Finish | Overall Length (in) | Weight (lbs) |
|-------------------|-----------------|-------------|---------------------|--------------|
| J5449-14BL | 1/2 | Black Oxide | 14 | 2.03 |



ASME B107.500



1/2" DRIVE RATCHET ADAPTER

- › Converts standard handles to ratcheting handles.

| Product # | Drive Size (in) | Finish | Overall Length (in) | Weight (lbs) |
|--------------|-----------------|-------------|---------------------|--------------|
| J5447 | 1/2 | Full Polish | 2-21/32 | 0.86 |



ASME B107.500



1/2" DRIVE HINGE HANDLE

- › Head Flexes 90° from horizontal.
- › Made of heat-treated alloy steel.
- › Chrome plated finish.

| Product # | Drive Size (in) | Finish | Overall Length (in) | Weight (lbs) |
|----------------|-----------------|-------------|---------------------|--------------|
| J5466 | 1/2 | Full Polish | 10-7/8 | 1.14 |
| J5467 | 1/2 | Full Polish | 15-3/4 | 1.52 |
| J5468 | 1/2 | Full Polish | 18-5/8 | 1.69 |
| J5468BL | 1/2 | Black Oxide | 18-5/8 | 1.69 |
| J5469 | 1/2 | Full Polish | 24 | 2.68 |



ASME B107.500





1/2" DRIVE SPEED HANDLE

- › Made from alloy steel.
- › Heat-treated for strength and durability.

| Product # | Drive Size (in) | Finish | Overall Length (in) | Weight (lbs) |
|---------------|-----------------|-------------|---------------------|--------------|
| J5480G | 1/2 | Full Polish | 18-5/16 | 1.55 |

 ASME B107.500



1/2" DRIVE SLIDING T-HANDLE

- › Made from alloy steel.
- › Heat-treated for strength and durability.

| Product # | Drive Size (in) | Finish | Overall Length (in) | Weight (lbs) |
|--------------|-----------------|-------------|---------------------|--------------|
| J5485 | 1/2 | Full Polish | 12-15/16 | 1.11 |

 ASME B107.500



1/2" DRIVE STANDARD EXTENSIONS

- › Made from alloy steel.
- › Heat-treated for strength and durability.
- › Rigid extensions.

| Product # | Drive Size (in) | Finish | Overall Length (in) | Weight (lbs) |
|---------------|-----------------|-------------|---------------------|--------------|
| J5460 | 1/2 | Full Polish | 2-1/2 | 0.24 |
| J5460B | 1/2 | Black Oxide | 2-1/2 | 0.24 |
| J5461 | 1/2 | Full Polish | 5 | 0.44 |
| J5461B | 1/2 | Black Oxide | 5 | 0.44 |
| J5463 | 1/2 | Full Polish | 10 | 0.89 |
| J5463B | 1/2 | Black Oxide | 10 | 0.89 |
| J5464 | 1/2 | Full Polish | 20 | 1.87 |
| J5465 | 1/2 | Full Polish | 36 | 3.41 |

 ASME B107.500



1/2" DRIVE WOBBLE EXTENSIONS

- › Provides up to a 17° angle of operation.
- › Made from alloy steel.
- › Heat-treated for strength and durability.
- › Rigid extension.

| Product # | Drive Size (in) | Finish | Overall Length (in) | Weight (lbs) |
|---------------|-----------------|-------------|---------------------|--------------|
| J5460W | 1/2 | Full Polish | 2-1/2 | 0.24 |
| J5461W | 1/2 | Full Polish | 5 | 0.44 |
| J5463W | 1/2 | Full Polish | 10 | 0.89 |
| J5464W | 1/2 | Full Polish | 20 | 1.90 |

 ASME B107.500

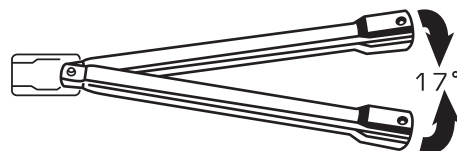

1/2" DRIVE LOCKING EXTENSIONS

- › Push button locking mechanism.
- › Over-molded protection cap prevents dust and debris from jamming mechanism.

| Product # | Drive Size (in) | Finish | Overall Length (in) | Weight (lbs) |
|------------------|-----------------|-------------|---------------------|--------------|
| J5460-03L | 1/2 | Full Polish | 3 | 0.40 |
| J5461L | 1/2 | Full Polish | 5 | 0.55 |
| J5463L | 1/2 | Full Polish | 10 | 1.04 |

 ASME B107.500



1/2" DRIVE ADAPTERS

| Product # | Size (in) | Finish | Overall Length (in) | Weight (lbs) |
|--------------|-----------------|-------------|---------------------|--------------|
| J5253 | 3/8" F x 1/2" M | Full Polish | 1-7/16 | 0.11 |
| J5254 | 1/2" F x 3/8" M | Full Polish | 1-3/8 | 0.13 |
| J5653 | 1/2" F x 3/4" M | Full Polish | 1-11/16 | 0.24 |
| J5453 | 3/4" F x 1/2" M | Full Polish | 1-7/8 | 0.39 |

 ASME B107.500



1/2" DRIVE LOCKING ADAPTER

- › Includes hex key for easy locking onto drive tool.
- › Knurl locking ring.

| Product # | Drive Size (in) | Finish | Overall Length (in) | Weight (lbs) |
|--------------------|-----------------|-------------|---------------------|--------------|
| J5460-02BLS | 1/2 | Black Oxide | 3 | 0.36 |





1/2" DRIVE UNIVERSAL JOINT

| Product # | Drive Size (in) | Finish | Overall Length (in) | Weight (lbs) |
|---------------|-----------------|-------------|---------------------|--------------|
| J5470A | 1/2 | Full Polish | 2-3/4 | 0.30 |

 ASME B107.500



1/2" DRIVE SOCKETS - 6 POINT

- ▶ Proto® 6 Point Sockets are ideal for use on stubborn or damaged fasteners, and also on fasteners made from soft materials.
- ▶ TorquePlus™ features apply.



| Product # | Size (in) (A) | Nut End Outside Dia. (in) (B) | Drive End Outside Dia. (in) (C) | Nut Depth (in) (D) | Bolt Clearance Depth (in) (E) | Overall Length (in) (L) | Weight (lbs) |
|-----------|---------------|-------------------------------|---------------------------------|--------------------|-------------------------------|-------------------------|--------------|
| J5408H | 1/4 | 1/4 | 55/64 | 23/64 | 23/64 | 1-31/64 | 0.11 |
| J5410H | 5/16 | 17/32 | 55/64 | 23/64 | 25/32 | 1-31/64 | 0.11 |
| J5412H | 3/8 | 9/16 | 55/64 | 23/64 | 7/8 | 1-31/64 | 0.11 |
| J5414H | 7/16 | 43/64 | 55/64 | 23/64 | 7/8 | 1-31/64 | 0.11 |
| J5416H | 1/2 | 47/64 | 55/64 | 23/64 | 7/8 | 1-31/64 | 0.11 |
| J5418H | 9/16 | 13/16 | 55/64 | 23/64 | 53/64 | 1-1/2 | 0.13 |
| J5419H | 19/32 | 7/8 | 7/8 | 33/64 | 25/32 | 1-1/2 | 0.14 |
| J5420H | 5/8 | 7/8 | 7/8 | 9/16 | 21/32 | 1-1/2 | 0.14 |
| J5421H | 1-1/2 | 29/32 | 29/32 | 37/64 | 25/32 | 1-1/2 | 0.15 |
| J5422H | 11/16 | 61/64 | 61/64 | 9/16 | 21/32 | 1-1/2 | 0.15 |
| J5424H | 3/4 | 1-1/32 | 1-1/32 | 11/16 | 21/32 | 1-1/2 | 0.15 |
| J5425H | 1-1/2 | 1-1/16 | 1-1/16 | 11/16 | 25/32 | 1-1/2 | 0.19 |
| J5426H | 13/16 | 1-3/32 | 1-3/32 | 11/16 | 21/32 | 1-1/2 | 0.18 |
| J5428H | 7/8 | 1-11/64 | 1-11/64 | 11/16 | 45/64 | 1-9/16 | 0.26 |
| J5430H | 15/16 | 1-1/4 | 1-1/4 | 13/16 | 45/64 | 1-9/16 | 0.33 |
| J5431H | 1-9/16 | 1-9/32 | 1-9/32 | 13/16 | 27/32 | 1-9/16 | 0.31 |
| J5432H | 1 | 1-21/64 | 1-21/64 | 53/64 | 45/64 | 1-9/16 | 0.38 |
| J5434H | 1-1/16 | 1-13/32 | 1-13/32 | 13/16 | 25/32 | 1-41/64 | 0.42 |
| J5436H | 1-1/8 | 1-31/64 | 1-31/64 | 59/64 | 25/32 | 1-3/4 | 0.47 |
| J5438H | 1-3/16 | 1-9/16 | 1-9/16 | 59/64 | 25/32 | 1-3/4 | 0.59 |
| J5440H | 1-1/4 | 1-39/64 | 1-39/64 | 1 | 57/64 | 1-55/64 | 0.66 |
| J5442H | 1-15/16 | 1-21/32 | 1-21/32 | 27/32 | 49/64 | 1-3/4 | 0.69 |
| J5444H | 1-3/8 | 1-25/32 | 1-21/32 | 27/32 | 1-11/64 | 2-1/8 | 0.79 |
| J5446H | 1-7/16 | 1-59/64 | 1-21/32 | 27/32 | 1-11/64 | 2-1/8 | 0.98 |
| J5448H | 1-1/2 | 1-63/64 | 1-21/32 | 27/32 | 1-11/64 | 2-1/4 | 0.96 |
| J5450H | 1-9/16 | 2-1/32 | 1-5/8 | 1 | 1-9/32 | 2-1/4 | 1.12 |



ASME B107.1



PRODUCT FEATURES AND BENEFITS —



- ▶ High performance drive configuration allows for quick and easy socket engagement to the fastener flats, not the corners.
- ▶ Employs a radius-corner design, shifting contact area and stress away from the fastener corners and distributing contact stresses over a large area of the socket, minimizing slippage.
- ▶ The internal design minimizes fastener rounding, helps to extend fastener life, and allows the user to more easily turn worn, rounded, or rusted fasteners.

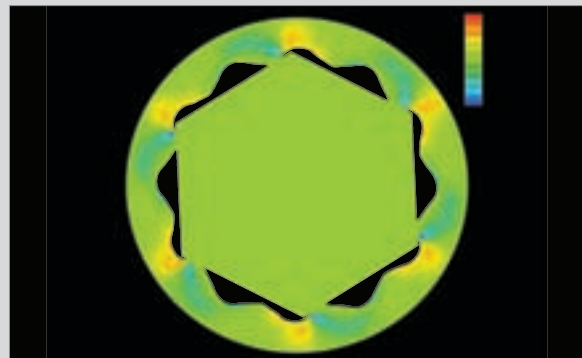



1/2" DRIVE METRIC SOCKETS - 6 POINT



- › Proto® 6 Point Sockets are ideal for use on stubborn or damaged fasteners, and also on fasteners made from soft materials.
- › TorquePlus™ features apply.



| Product # | Size (mm) (A) | Nut End Outside Dia. (in) (B) | Drive End Outside Dia. (in) (C) | Nut Depth (in) (D) | Bolt Clearance Depth (in) (E) | Overall Length (in) (L) | Weight (lbs) |
|-----------|---------------|-------------------------------|---------------------------------|--------------------|-------------------------------|-------------------------|--------------|
| J5408MH | 8 | 35/64 | 55/64 | 23/64 | 47/64 | 1-31/64 | 0.11 |
| J5409MH | 9 | 19/32 | 55/64 | 23/64 | 47/64 | 1-31/64 | 0.12 |
| J5410MH | 10 | 39/64 | 55/64 | 23/64 | 25/32 | 1-31/64 | 0.09 |
| J5411MH | 11 | 45/64 | 55/64 | 23/64 | 25/32 | 1-31/64 | 0.10 |
| J5412MH | 12 | 47/64 | 55/64 | 23/64 | 25/32 | 1-31/64 | 0.10 |
| J5413MH | 13 | 3/4 | 55/64 | 23/64 | 25/32 | 1-31/64 | 0.12 |
| J5414MH | 14 | 13/16 | 55/64 | 23/64 | 25/32 | 1-31/64 | 0.13 |
| J5415MH | 15 | 55/64 | 55/64 | 37/64 | 25/32 | 1-1/2 | 0.13 |
| J5416MH | 16 | 55/64 | 55/64 | 37/64 | 25/32 | 1-1/2 | 0.14 |
| J5417MH | 17 | 61/64 | 61/64 | 37/64 | 25/32 | 1-1/2 | 0.17 |
| J5418MH | 18 | 61/64 | 61/64 | 37/64 | 25/32 | 1-1/2 | 0.17 |
| J5419MH | 19 | 1-1/32 | 1-1/32 | 11/16 | 25/32 | 1-1/2 | 0.19 |
| J5420MH | 20 | 1-3/32 | 1-3/32 | 11/16 | 55/64 | 1-1/2 | 0.22 |
| J5421MH | 21 | 1-3/32 | 1-3/32 | 11/16 | 55/64 | 1-1/2 | 0.24 |
| J5422MH | 22 | 1-3/16 | 1-3/16 | 45/64 | 29/32 | 1-17/32 | 0.26 |
| J5423MH | 23 | 1-13/64 | 1-13/64 | 13/16 | 29/32 | 1-17/32 | 0.27 |
| J5424MH | 24 | 1-1/4 | 1-1/4 | 27/32 | 29/32 | 1-17/32 | 0.28 |
| J5425MH | 25 | 1-5/16 | 1-5/16 | 27/32 | 29/32 | 1-17/32 | 0.30 |
| J5426MH | 26 | 1-11/32 | 1-11/32 | 57/64 | 29/32 | 1-39/64 | 0.33 |
| J5427MH | 27 | 1-25/64 | 1-25/64 | 55/64 | 1-3/64 | 1-43/64 | 0.39 |
| J5428MH | 28 | 1-9/32 | 1-29/64 | 61/64 | 1-5/32 | 1-25/32 | 0.48 |
| J5429MH | 29 | 1-31/64 | 1-31/64 | 61/64 | 1-5/32 | 1-25/32 | 0.48 |
| J5430MH | 30 | 1-9/16 | 1-17/32 | 61/64 | 1-5/32 | 1-25/32 | 0.53 |
| J5431MH | 31 | 1-5/8 | 1-5/8 | 61/64 | 1-5/32 | 1-25/32 | 0.53 |
| J5432MH | 32 | 1-5/8 | 1-5/8 | 1 | 1-5/32 | 1-27/32 | 0.57 |
| J5434MH | 34 | 1-49/64 | 1-21/32 | 7/8 | 1-5/32 | 2-1/4 | 0.86 |
| J5436MH | 36 | 1-59/64 | 1-21/32 | 1 | 1-5/32 | 2-1/4 | 0.86 |



ASME B107.5M

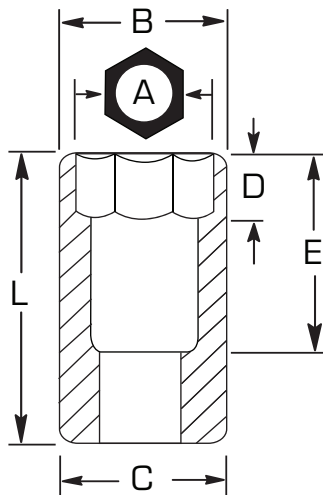



1/2" DRIVE DEEP SOCKETS - 6 POINT

- ▶ Proto® 6 Point Sockets are ideal for use on stubborn or damaged fasteners, and also on fasteners made from soft materials.
- ▶ TorquePlus™ features apply.



| Product # | Size (in) (A) | Nut End Outside Dia. (in) (B) | Drive End Outside Dia. (in) (C) | Nut Depth (in) (D) | Bolt Clearance Depth (in) (E) | Overall Length (in) (L) | Weight (lbs) |
|-----------|---------------|-------------------------------|---------------------------------|--------------------|-------------------------------|-------------------------|--------------|
| J5312H | 3/8 | 9/16 | 7/8 | 1/4 | 2-39/64 | 3-1/4 | 0.30 |
| J5314H | 7/16 | 9/16 | 7/8 | 23/64 | 2-39/64 | 3-1/4 | 0.30 |
| J5316H | 1/2 | 47/64 | 55/64 | 25/32 | 2-39/64 | 3-1/4 | 0.31 |
| J5318H | 9/16 | 13/16 | 27/32 | 7/8 | 2-39/64 | 3-1/4 | 0.31 |
| J5320H | 5/8 | 7/8 | 7/8 | 1-3/16 | 2-39/64 | 3-1/4 | 0.31 |
| J5322H | 11/16 | 31/32 | 31/32 | 1-3/16 | 2-39/64 | 3-1/4 | 0.33 |
| J5324H | 3/4 | 1-3/64 | 1-3/64 | 1-3/16 | 2-39/64 | 3-1/4 | 0.40 |
| J5326H | 13/16 | 1-1/8 | 1-1/8 | 1-3/16 | 2-39/64 | 3-1/4 | 0.43 |
| J5328H | 7/8 | 1-11/64 | 1-11/64 | 1-3/16 | 2-39/64 | 3-1/4 | 0.54 |
| J5330H | 15/16 | 1-1/4 | 1-1/4 | 1-3/16 | 2-39/64 | 3-1/4 | 0.65 |
| J5332H | 1 | 1-21/64 | 1-21/64 | 1-3/16 | 2-39/64 | 3-1/4 | 0.71 |
| J5334H | 1-1/16 | 1-7/16 | 1-7/16 | 1-3/16 | 2-1/4 | 3-1/4 | 0.72 |
| J5336H | 1-1/8 | 1-1/2 | 1-1/2 | 1 | 2-1/4 | 3-1/4 | 0.74 |
| J5338H | 1-3/16 | 1-35/64 | 1-35/64 | 1-3/32 | 2-1/4 | 3-1/4 | 0.85 |
| J5340H | 1-1/4 | 1-19/32 | 1-19/32 | 1-3/16 | 2-1/4 | 3-1/4 | 1.02 |
| J5342H | 1-5/16 | 1-7/8 | 1-5/8 | 27/32 | 2-19/64 | 3-1/2 | 1.06 |
| J5344H | 1-3/8 | 1-7/8 | 1-5/8 | 29/32 | 2-1/4 | 3-1/2 | 1.23 |
| J5346H | 1-7/16 | 2-1/16 | 1-5/8 | 61/64 | 2-1/4 | 3-1/2 | 1.27 |
| J5348H | 1-1/2 | 2 | 1-5/8 | 1 | 2-1/4 | 3-1/2 | 1.58 |



ASME B107.1

1/2" DRIVE SOCKETS - 8 POINT

| Product # | Size (in) (A) | Nut End Outside Dia. (in) (B) | Drive End Outside Dia. (in) (C) | Nut Depth (in) (D) | Bolt Clearance Depth (in) (E) | Overall Length (in) (L) | Weight (lbs) |
|-----------|---------------|-------------------------------|---------------------------------|--------------------|-------------------------------|-------------------------|--------------|
| J5412S | 3/8 | 45/64 | 55/64 | 1/4 | 1-1/64 | 1-7/16 | 0.11 |
| J5414S | 7/16 | 51/64 | 51/64 | 5/16 | 1-1/8 | 1-7/16 | 0.11 |
| J5416S | 1/2 | 59/64 | 59/64 | 11/32 | 1-3/32 | 1-7/16 | 0.11 |
| J5418S | 9/16 | 1 | 1 | 3/8 | 1-1/64 | 1-1/2 | 0.13 |
| J5420S | 5/8 | 1-5/64 | 1-5/64 | 37/64 | 1-3/32 | 1-1/2 | 0.14 |
| J5422S | 11/16 | 1-11/64 | 1-11/64 | 13/32 | 1-1/64 | 1-1/2 | 0.15 |
| J5424S | 3/4 | 1-15/64 | 1-15/64 | 29/64 | 1-1/16 | 1-1/2 | 0.18 |
| J5426S | 13/16 | 1-23/64 | 1-23/64 | 27/32 | 1-5/32 | 1-5/8 | 0.23 |
| J5428S | 7/8 | 1-1/2 | 1-1/2 | 27/32 | 1-1/8 | 1-5/8 | 0.51 |
| J5432S | 1 | 1-11/16 | 1-11/16 | 3/4 | 11/16 | 1-3/4 | 0.80 |



ASME B107.1





1/2" DRIVE SOCKETS - 12 POINT

- › Proto® 12 Point Sockets are ideal for use on stubborn or damaged fasteners, and also on fasteners made from soft materials.
- › TorquePlus™ features apply.



| Product # | Size (in) (A) | Nut End Outside Dia. (in) (B) | Drive End Outside Dia. (in) (C) | Nut Depth (in) (D) | Bolt Clearance Depth (in) (E) | Overall Length (in) (L) | Weight (lbs) |
|-----------|---------------|-------------------------------|---------------------------------|--------------------|-------------------------------|-------------------------|--------------|
| J5408T | 1/4 | 1/4 | 23/32 | 23/64 | 23/32 | 1-34/64 | 0.11 |
| J5410 | 5/16 | 17/32 | 55/64 | 23/64 | 23/32 | 1-34/64 | 0.11 |
| J5412 | 3/8 | 9/16 | 55/64 | 23/64 | 7/8 | 1-31/64 | 0.11 |
| J5414 | 7/16 | 43/64 | 55/64 | 23/64 | 7/8 | 1-31/64 | 0.11 |
| J5416 | 1/2 | 47/64 | 55/64 | 23/64 | 7/8 | 1-31/64 | 0.11 |
| J5417 | 17/32 | 7/8 | 55/64 | 23/64 | 23/32 | 1-31/64 | 0.12 |
| J5418 | 9/16 | 13/16 | 55/64 | 23/64 | 51/64 | 1-1/2 | 0.13 |
| J5419 | 19/32 | 7/8 | 55/64 | 9/16 | 21/32 | 1-1/2 | 0.13 |
| J5420 | 5/8 | 7/8 | 7/8 | 9/16 | 21/32 | 1-1/2 | 0.14 |
| J5421 | 21/32" | 61/64 | 61/64 | 9/16 | 21/32 | 1-1/2 | 0.15 |
| J5422 | 11/16 | 61/64 | 61/64 | 9/16 | 21/32 | 1-1/2 | 0.15 |
| J5424 | 3/4 | 1-1/32 | 1-1/64 | 11/16 | 21/32 | 1-1/2 | 0.15 |
| J5425 | 25/32 | 1-1/16 | 1-5/64 | 11/16 | 21/32 | 1-1/2 | 0.20 |
| J5426 | 13/16 | 1-3/32 | 1-5/64 | 11/16 | 21/32 | 1-1/2 | 0.23 |
| J5428 | 7/8 | 1-11/64 | 1-3/16 | 11/16 | 45/64 | 1-9/16 | 0.26 |
| J5429 | 29/32 | 1-3/16 | 1-3/16 | 13/16 | 45/64 | 1-9/16 | 0.30 |
| J5430 | 15/16 | 1-1/4 | 1-1/4 | 13/16 | 45/64 | 1-9/16 | 0.33 |
| J5431 | 31/32 | 1-9/32 | 1-9/32 | 13/16 | 45/64 | 1-9/16 | 0.35 |
| J5432 | 1 | 1-21/64 | 1-5/16 | 27/32 | 45/64 | 1-9/16 | 0.38 |
| J5434 | 1-1/16 | 1-13/32 | 1-25/64 | 13/16 | 25/32 | 1-5/8 | 0.42 |
| J5436 | 1-1/8 | 1-31/64 | 1-31/64 | 15/16 | 29/32 | 1-3/4 | 0.47 |
| J5438 | 1-3/16 | 1-9/16 | 1-17/32 | 59/64 | 29/32 | 1-3/4 | 0.59 |
| J5440 | 1-1/4 | 1-39/64 | 1-37/64 | 1 | 7/8 | 1-3/4 | 0.66 |
| J5442 | 1-5/16 | 1-21/32 | 1-41/64 | 27/32 | 1-19/64 | 1-55/64 | 0.69 |
| J5444 | 1-3/8 | 1-25/32 | 1-5/8 | 25/32 | 1-19/64 | 2 | 0.79 |
| J5446 | 1-7/16 | 1-59/64 | 1-5/8 | 27/32 | 1-19/64 | 2-1/8 | 0.98 |
| J5448 | 1-1/2 | 1-63/64 | 1-5/8 | 27/32 | 1-19/64 | 2-1/4 | 1.12 |



AS954E S3.8.1

ASME B107.1

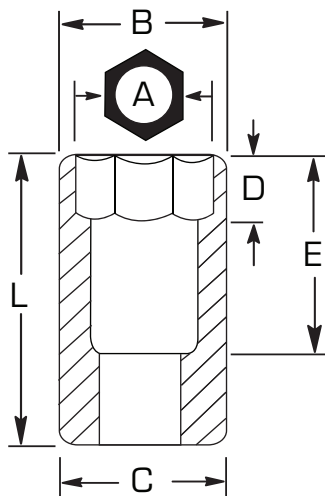

1/2" DRIVE METRIC SOCKETS - 12 POINT



- ▶ Proto® 12 Point Sockets are ideal for use on stubborn or damaged fasteners, and also on fasteners made from soft materials.
- ▶ TorquePlus™ features apply.



| Product # | Size (mm) (A) | Nut End Outside Dia. (in) (B) | Drive End Outside Dia. (in) (C) | Nut Depth (in) (D) | Bolt Clearance Depth (in) (E) | Overall Length (in) (L) | Weight (lbs) |
|-----------|------------------|----------------------------------|------------------------------------|-----------------------|----------------------------------|----------------------------|--------------|
| J5408M | 8 | 35/64 | 55/64 | 23/64 | 25/32 | 1-19/64 | 0.11 |
| J5409M | 9 | 19/32 | 55/64 | 23/64 | 25/32 | 1-31/64 | 0.11 |
| J5410M | 10 | 39/64 | 55/64 | 23/64 | 55/64 | 1-31/64 | 0.11 |
| J5411M | 11 | 45/64 | 55/64 | 23/64 | 55/64 | 1-31/64 | 0.11 |
| J5412M | 12 | 47/64 | 55/64 | 23/64 | 55/64 | 1-31/64 | 0.11 |
| J5413M | 13 | 3/4 | 55/64 | 23/64 | 55/64 | 1-31/64 | 0.12 |
| J5414M | 14 | 13/16 | 55/64 | 23/64 | 7/8 | 1-1/2 | 0.13 |
| J5415M | 15 | 55/64 | 55/64 | 37/64 | 7/8 | 1-1/2 | 0.13 |
| J5416M | 16 | 7/8 | 7/8 | 37/64 | 7/8 | 1-1/2 | 0.13 |
| J5417M | 17 | 61/64 | 61/64 | 37/64 | 7/8 | 1-1/2 | 0.14 |
| J5418M | 18 | 61/64 | 61/64 | 37/64 | 7/8 | 1-1/2 | 0.17 |
| J5419M | 19 | 1-1/32 | 1-1/32 | 11/16 | 27/32 | 1-1/2 | 0.19 |
| J5420M | 20 | 1-3/32 | 1-3/32 | 11/16 | 27/32 | 1-1/2 | 0.22 |
| J5421M | 21 | 1-3/32 | 1-3/32 | 11/16 | 27/32 | 1-1/2 | 0.24 |
| J5422M | 22 | 1-11/64 | 1-11/64 | 11/16 | 27/32 | 1-17/32 | 0.26 |
| J5423M | 23 | 1-13/64 | 1-13/64 | 25/32 | 59/64 | 1-17/32 | 0.27 |
| J5424M | 24 | 1-1/4 | 1-1/4 | 53/64 | 59/64 | 1-17/32 | 0.28 |
| J5425M | 25 | 1-9/32 | 1-9/32 | 53/64 | 59/64 | 1-17/32 | 0.30 |
| J5426M | 26 | 1-21/64 | 1-21/64 | 55/64 | 63/64 | 1-39/64 | 0.33 |
| J5427M | 27 | 1-13/32 | 1-13/32 | 15/16 | 1-3/64 | 1-43/64 | 0.39 |
| J5428M | 28 | 1-31/64 | 1-31/64 | 63/64 | 1-5/32 | 1-25/32 | 0.48 |
| J5429M | 29 | 1-31/64 | 1-31/64 | 63/64 | 1-5/32 | 1-25/32 | 0.62 |
| J5430M | 30 | 1-9/16 | 1-17/32 | 63/64 | 1-5/32 | 1-25/32 | 0.63 |
| J5431M | 31 | 1-39/64 | 1-39/64 | 1-1/16 | 1-5/32 | 1-25/32 | 0.63 |
| J5432M | 32 | 1-39/64 | 1-39/64 | 1-1/8 | 1-7/32 | 1-27/32 | 0.63 |
| J5434M | 34 | 1-49/64 | 1-49/64 | 1 | 1-35/64 | 1-27/32 | 0.63 |
| J5436M | 36 | 1-31/32 | 1-31/32 | 1-3/8 | 1-39/64 | 2-15/64 | 1.04 |
| J5438M | 38 | 2-1/32 | 2-1/32 | 1-3/8 | 1-39/64 | 2-1/4 | 1.04 |



AS954E S3.8.1

ASME B107.5M

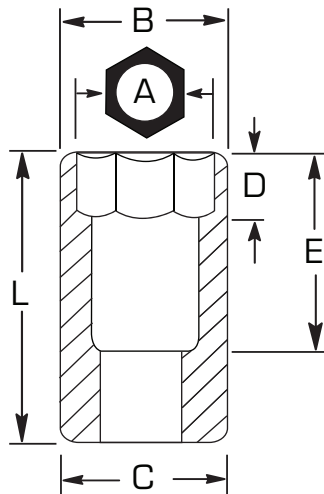



1/2" DRIVE BLACK OXIDE SOCKETS - 12 POINT

- ▶ Proto® 12 Point Sockets are ideal for use on stubborn or damaged fasteners, and also on fasteners made from soft materials.
- ▶ TorquePlus™ features apply.



| Product # | Size (in) (A) | Nut End Outside Dia. (in) (B) | Drive End Outside Dia. (in) (C) | Nut Depth (in) (D) | Bolt Clearance Depth (in) (E) | Overall Length (in) (L) | Weight (lbs) |
|-----------|---------------|-------------------------------|---------------------------------|--------------------|-------------------------------|-------------------------|--------------|
| J5412B | 3/8 | 9/16 | 55/64 | 23/64 | 7/8 | 1-1/2 | 0.10 |
| J5414B | 7/16 | 43/64 | 55/64 | 23/64 | 7/8 | 1-1/2 | 0.12 |
| J5416B | 1/2 | 47/64 | 55/64 | 23/64 | 7/8 | 1-1/2 | 0.12 |
| J5418B | 9/16 | 13/16 | 55/64 | 23/64 | 51/64 | 1-1/2 | 0.12 |
| J5420B | 5/8 | 7/8 | 7/8 | 9/16 | 21/37 | 1-1/2 | 0.12 |
| J5422B | 11/16 | 61/64 | 61/64 | 9/16 | 21/32 | 1-1/2 | 0.15 |
| J5424B | 3/4 | 1-1/32 | 1-1/32 | 11/16 | 21/32 | 1-1/2 | 0.17 |
| J5426B | 13/16 | 1-3/32 | 1-3/32 | 11/16 | 21/32 | 1-1/2 | 0.20 |
| J5428B | 7/8 | 1-11/64 | 1-11/64 | 11/16 | 45/64 | 1-9/16 | 0.25 |
| J5430B | 15/16 | 1-1/4 | 1-1/4 | 13/16 | 45/64 | 1-9/16 | 0.27 |
| J5432B | 1 | 1-5/16 | 1-3/16 | 27/32 | 45/64 | 1-9/16 | 0.31 |
| J5434B | 1-1/16 | 1-25/64 | 1-25/64 | 13/16 | 25/32 | 1-5/8 | 0.37 |
| J5436B | 1-1/8 | 1-31/64 | 1-31/64 | 15/16 | 29/32 | 1-3/4 | 0.44 |
| J5438B | 1-3/16 | 1-17/32 | 1-17/32 | 59/64 | 29/32 | 1-3/4 | 0.45 |
| J5440B | 1-1/4 | 1-37/64 | 1-37/64 | 1 | 7/8 | 1-21/32 | 0.43 |
| J5442B | 1-5/16 | 1-41/64 | 1-41/64 | 1-27/32 | 1-19/64 | 1-3/4 | 0.52 |
| J5444B | 1-3/8 | 1-51/64 | 1-5/8 | 1-31/32 | 1-19/64 | 2 | 0.67 |
| J5446B | 1-7/16 | 1-59/64 | 1-5/8 | 1-27/32 | 1-19/64 | 2-1/8 | 0.80 |
| J5448B | 1-1/2 | 1-63/64 | 1-5/8 | 1-27/32 | 1-19/64 | 2-1/4 | 0.85 |

AS954E S3.8.1 ASME B107.1

1/2" DRIVE DEEP SOCKETS - 12 POINT

- ▶ Proto® 12 Point Sockets are ideal for use on stubborn or damaged fasteners, and also on fasteners made from soft materials.
- ▶ TorquePlus™ features apply.



| Product # | Size (in) (A) | Nut End Outside Dia. (in) (B) | Drive End Outside Dia. (in) (C) | Nut Depth (in) (D) | Bolt Clearance Depth (in) (E) | Overall Length (in) (L) | Weight (lbs) |
|-----------|---------------|-------------------------------|---------------------------------|--------------------|-------------------------------|-------------------------|--------------|
| J5312 | 3/8 | 9/16 | 7/8 | 1/4 | 2-39/64 | 3-1/4 | 0.28 |
| J5314 | 7/16 | 9/16 | 7/8 | 23/64 | 2-39/64 | 3-1/4 | 0.28 |
| J5316 | 1/2 | 47/64 | 55/64 | 25/32 | 2-39/64 | 3-1/4 | 0.29 |
| J5318 | 9/16 | 13/16 | 27/32 | 15/16 | 2-39/64 | 3-1/4 | 0.29 |
| J5320 | 5/8 | 7/8 | 7/8 | 1-7/32 | 2-39/64 | 3-1/4 | 0.30 |
| J5322 | 11/16 | 31/32 | 31/32 | 1-7/32 | 2-39/64 | 3-1/4 | 0.42 |
| J5324 | 3/4 | 1-3/64 | 1-3/64 | 1-7/32 | 2-39/64 | 3-1/4 | 0.42 |
| J5326 | 13/16 | 1-3/32 | 1-3/32 | 1-7/32 | 2-39/64 | 3-1/4 | 0.52 |
| J5328 | 7/8 | 1-11/64 | 1-11/64 | 1-7/32 | 2-39/64 | 3-1/4 | 0.58 |
| J5330 | 15/16 | 1-1/4 | 1-1/4 | 1-7/32 | 2-39/64 | 3-1/4 | 0.67 |
| J5332 | 1 | 1-21/64 | 1-21/64 | 1-7/32 | 2-29/64 | 3-1/4 | 0.67 |
| J5334 | 1-1/16 | 1-13/32 | 1-13/32 | 1-9/32 | 2-29/64 | 3-1/4 | 0.75 |
| J5336 | 1-1/8 | 1-1/2 | 1-1/2 | 1-5/32 | 2-29/64 | 3-1/4 | 0.83 |
| J5340 | 1-1/4 | 1-9/16 | 1-9/16 | 1-13/32 | 2-29/64 | 3-1/4 | 1.06 |
| J5338 | 1-3/16 | 1-35/64 | 1-35/64 | 1-7/64 | 2-1/4 | 3-1/4 | 0.83 |
| J5342 | 1-5/16 | 1-7/8 | 1-5/8 | 27/32 | 2-1/4 | 3-1/2 | 1.06 |
| J5344 | 1-3/8 | 1-7/8 | 1-5/8 | 61/64 | 2-1/4 | 3-1/2 | 1.23 |
| J5346 | 1-7/16 | 2-1/16 | 1-5/8 | 61/64 | 2-1/4 | 3-1/2 | 1.27 |
| J5348 | 1-1/2 | 2-1/16 | 1-5/8 | 1 | 2-1/4 | 3-1/2 | 1.58 |

AS954E S3.8.1 ASME B107.1



1/2" DRIVE METRIC DEEP SOCKETS - 12 POINT

METRIC

- ▶ Proto® 12 Point Sockets are ideal for use on stubborn or damaged fasteners, and also on fasteners made from soft materials.
- ▶ TorquePlus™ features apply.



| Product # | Size (mm) (A) | Nut End Outside Dia. (in) (B) | Drive End Outside Dia. (in) (C) | Nut Depth (in) (D) | Bolt Clearance Depth (in) (E) | Overall Length (in) (L) | Weight (lbs) |
|-----------|---------------|-------------------------------|---------------------------------|--------------------|-------------------------------|-------------------------|--------------|
| J5310M | 10 | 39/64 | 55/64 | 19/32 | 2-3/32 | 3-1/4 | 0.25 |
| J5311M | 11 | 45/64 | 55/64 | 5/8 | 2-3/32 | 3-1/4 | 0.25 |
| J5312M | 12 | 47/64 | 55/64 | 43/64 | 2-3/32 | 3-1/4 | 0.26 |
| J5313M | 13 | 3/4 | 55/64 | 43/64 | 2-3/32 | 3-1/4 | 0.26 |
| J5314M | 14 | 27/32 | 27/32 | 15/16 | 2-3/32 | 3-1/4 | 0.30 |
| J5315M | 15 | 55/64 | 55/64 | 1-1/16 | 2-3/32 | 3-1/4 | 0.32 |
| J5316M | 16 | 55/64 | 55/64 | 1-3/16 | 2-3/32 | 3-1/4 | 0.32 |
| J5317M | 17 | 61/64 | 61/64 | 1-3/16 | 2-3/32 | 3-1/4 | 0.33 |
| J5318M | 18 | 63/64 | 63/64 | 1-3/16 | 2-3/32 | 3-1/4 | 0.33 |
| J5319M | 19 | 1-3/64 | 1-3/64 | 1-3/16 | 2-3/32 | 3-1/4 | 0.37 |
| J5320M | 20 | 1-3/32 | 1-3/32 | 1-3/16 | 2-3/32 | 3-1/4 | 0.46 |
| J5321M | 21 | 1-3/32 | 1-3/32 | 1-3/16 | 2-3/32 | 3-1/4 | 0.51 |
| J5322M | 22 | 1-11/64 | 1-11/64 | 1-3/16 | 2-3/32 | 3-1/4 | 0.51 |
| J5323M | 23 | 1-13/64 | 1-13/64 | 1-3/16 | 2-3/32 | 3-1/4 | 0.51 |
| J5324M | 24 | 1-1/4 | 1-1/4 | 1-3/16 | 2-3/32 | 3-1/4 | 0.51 |
| J5325M | 25 | 1-5/16 | 1-5/16 | 1-3/16 | 2-3/32 | 3-1/4 | 0.62 |
| J5326M | 26 | 1-21/64 | 1-21/64 | 1-3/16 | 2-3/32 | 3-1/4 | 0.63 |
| J5327M | 27 | 1-1/64 | 1-1/64 | 1-7/64 | 2-3/32 | 3-1/4 | 0.65 |
| J5328M | 28 | 1-3/32 | 1-31/64 | 1-7/64 | 2-3/32 | 3-1/4 | 0.68 |
| J5329M | 29 | 1-31/64 | 1-31/64 | 1-7/64 | 2-3/32 | 3-1/4 | 0.68 |
| J5330M | 30 | 1-9/16 | 1-9/16 | 1-7/64 | 2-5/8 | 3-1/4 | 0.70 |
| J5331M | 31 | 1-39/64 | 1-39/64 | 1-7/64 | 2-5/8 | 3-1/4 | 0.73 |
| J5332M | 32 | 1-39/64 | 1-39/64 | 1-7/64 | 2-5/8 | 3-1/4 | 0.73 |
| J5336M | 36 | 1-31/32 | 1-31/32 | 1-7/64 | 2-5/8 | 3-1/4 | 0.99 |



AS954E S3.8.1

ASME B107.5M

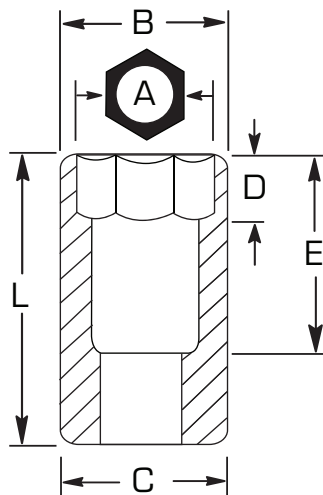



1/2" DRIVE BLACK OXIDE DEEP SOCKETS - 12 POINT

- ▶ Proto® 12 Point Sockets are ideal for use on stubborn or damaged fasteners, and also on fasteners made from soft materials.
- ▶ TorquePlus™ features apply.



| Product # | Size (in) (A) | Nut End Outside Dia. (in) (B) | Drive End Outside Dia. (in) (C) | Nut Depth (in) (D) | Bolt Clearance Depth (in) (E) | Overall Length (in) (L) | Weight (lbs) |
|-----------|---------------|-------------------------------|---------------------------------|--------------------|-------------------------------|-------------------------|--------------|
| J5316B | 1/2 | 47/64 | 55/64 | 51/64 | 2-1/8 | 3-1/4 | 0.27 |
| J5318B | 9/16 | 13/16 | 55/64 | 7/8 | 2-1/8 | 3-1/4 | 0.31 |
| J5320B | 5/8 | 7/8 | 7/8 | 1-3/16 | 2-1/8 | 3-1/4 | 0.28 |
| J5322B | 11/16 | 61/64 | 61/64 | 1-3/16 | 2-1/8 | 3-1/4 | 0.33 |
| J5324B | 3/4 | 1-3/64 | 1-3/64 | 1-3/16 | 2-1/8 | 3-1/4 | 0.39 |
| J5326B | 13/16 | 1-3/32 | 1-3/32 | 1-3/16 | 2-1/8 | 3-1/4 | 0.42 |
| J5328B | 7/8 | 1-11/64 | 1-11/64 | 1-3/16 | 2-1/8 | 3-1/4 | 0.50 |
| J5330B | 15/16 | 1-1/4 | 1-1/4 | 1-3/16 | 2-1/8 | 3-1/4 | 0.55 |
| J5332B | 1 | 1-21/64 | 1-21/64 | 1-3/16 | 2-1/8 | 3-1/4 | 0.59 |
| J5334B | 1-1/16 | 1-13/32 | 1-13/32 | 1-3/16 | 2-1/8 | 3-1/4 | 0.69 |
| J5336B | 1-1/8 | 1-31/64 | 1-31/64 | 1-3/16 | 2-1/8 | 3-1/4 | 0.76 |
| J5340B | 1-1/4 | 1-37/64 | 1-37/64 | 1-3/16 | 2-1/8 | 3-1/4 | 0.79 |



AS954E S3.8.1

ASME B107.1

1/2" DRIVE SOCKETS - SPLINE

- ▶ Proto® Spline tools are designed to service high tensile strength fasteners used widely on military and commercial aircraft and in heavy machinery applications where vibration is prevalent. They are also used in automotive and industrial areas where high performance torque needs to be achieved.
- ▶ Spline sockets help tighten high-strength bolts to high torque loads. They help lower the force required to turn standard fasteners by allowing the torque load to be moved away from the corners to help prevent fastener rounding. They also turn fasteners with damaged corners.
- ▶ Spline sockets on spline fasteners help deliver twice the torque of 12 point wrenches on double-box fasteners, and more torque than hex wrenches on hex fasteners.
- ▶ Spline helps reduce foreign object debris (FOD) by having a precise fit between the fastening tool and its fastener.



| Product # | Size (in) (A) | Spline Size | Nut End Outside Dia. (in) (B) | Drive End Outside Dia. (in) (C) | Nut Depth (in) (D) | Bolt Clearance Depth (in) (E) | Overall Length (in) (L) | Weight (lbs) |
|-----------|---------------|-------------|-------------------------------|---------------------------------|--------------------|-------------------------------|-------------------------|--------------|
| J5416SPL | 1/2 | #16 | 7/8 | 7/8 | 31/64 | 13/16 | 1-7/16 | 0.11 |
| J5418SPL | 9/16 | #18 | 7/8 | 7/8 | 31/64 | 13/16 | 1-7/16 | 0.11 |
| J5420SPL | 5/8 | #20 | 7/8 | 7/8 | 17/32 | 1-1/16 | 1-9/16 | 0.14 |
| J5422SPL | 11/16 | #22 | 61/64 | 61/64 | 17/32 | 1-1/16 | 1-9/16 | 0.17 |
| J5424SPL | 3/4 | #24 | 1-3/64 | 1-3/64 | 17/32 | 1-1/16 | 1-9/16 | 0.20 |
| J5426SPL | 13/16 | #26 | 1-1/8 | 1-1/8 | 17/32 | 1-1/16 | 1-9/16 | 0.23 |
| J5428SPL | 7/8 | #28 | 1-3/16 | 1-3/16 | 17/32 | 1-1/16 | 1-9/16 | 0.24 |
| J5430SPL | 15/16 | #30 | 1-5/16 | 1-5/16 | 17/32 | 1-1/16 | 1-9/16 | 0.30 |





1/2" DRIVE DEEP SOCKETS - SPLINE

- ▶ Proto® Spline tools are designed to service high tensile strength fasteners used widely on military and commercial aircraft and in heavy machinery applications where vibration is prevalent. They are also used in automotive and industrial areas where high performance torque needs to be achieved.
- ▶ Spline sockets help tighten high-strength bolts to high torque loads. They help lower the force required to turn standard fasteners by allowing the torque load to be moved away from the corners to help prevent fastener rounding. They also turn fasteners with damaged corners.
- ▶ Spline sockets on spline fasteners help deliver twice the torque of 12 point wrenches on double-box fasteners, and more torque than hex wrenches on hex fasteners.
- ▶ Spline helps reduce foreign object debris (FOD) by having a precise fit between the fastening tool and its fastener.



| Product # | Size (in) (A) | Spline Size | Nut End Outside Dia. (in) (B) | Drive End Outside Dia. (in) (C) | Nut Depth (in) (D) | Bolt Clearance Depth (in) (E) | Overall Length (in) (L) | Weight (lbs) |
|-----------|---------------|-------------|-------------------------------|---------------------------------|--------------------|-------------------------------|-------------------------|--------------|
| J5316DPL | 1/2 | #16 | 7/8 | 7/8 | 31/64 | 2-7/8 | 3-3/8 | 0.24 |
| J5318DPL | 9/16 | #18 | 7/8 | 7/8 | 31/64 | 2-7/8 | 3-3/8 | 0.28 |
| J5320DPL | 5/8 | #20 | 7/8 | 7/8 | 33/64 | 2-7/8 | 3-3/8 | 0.32 |
| J5322DPL | 11/16 | #22 | 61/64 | 61/64 | 17/32 | 2-7/8 | 3-3/8 | 0.29 |
| J5324DPL | 3/4 | #24 | 1-3/64 | 1-3/64 | 17/32 | 2-7/8 | 3-3/8 | 0.33 |
| J5326DPL | 13/16 | #26 | 1-1/8 | 1-1/8 | 17/32 | 2-7/8 | 3-3/8 | 0.37 |
| J5328DPL | 7/8 | #28 | 1-3/16 | 1-3/16 | 17/32 | 2-7/8 | 3-3/8 | 0.41 |
| J5330DPL | 15/16 | #30 | 1-5/16 | 1-5/16 | 17/32 | 2-7/8 | 3-3/8 | 0.48 |

FEATURES AND BENEFITS — SPLINE SOCKETS

- ▶ High strength in a compact profile.
- ▶ Standard depth and deep sockets are available in the three smaller drive sizes - 1/4", 3/8", and 1/2".
- ▶ Can be used on spline fasteners, as well as on 4, 6, 8 or 12 point fasteners.

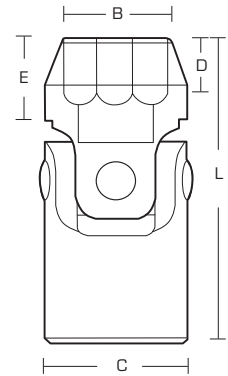
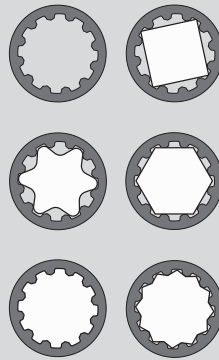

1/2" DRIVE METRIC UNIVERSAL SOCKETS - 6 POINT

METRIC

- ▶ Universal sockets permit turning at an angle up to 65° where obstructions may prevent a straight application.
- ▶ Proto® 6 Point Sockets are ideal for use on stubborn or damaged fasteners, and also on fasteners made from soft materials.
- ▶ TorquePlus™ features apply.



| Product # | Size (mm) (A) | Nut End Outside Dia. (in) (B) | Drive End Outside Dia. (in) (C) | Nut Depth (in) (D) | Bolt Clearance Depth (in) (E) | Overall Length (in) (L) | Weight (lbs) |
|-----------|---------------|-------------------------------|---------------------------------|--------------------|-------------------------------|-------------------------|--------------|
| J5484HAM | 21 | 1-3/16 | 1 | 1/2 | 1/2 | 2-9/16 | 0.37 |
| J5485HAM | 22 | 1-1/4 | 1 | 1/2 | 1/2 | 2-9/16 | 0.38 |
| J5487HAM | 24 | 1-3/16 | 1 | 9/16 | 9/16 | 2-9/16 | 0.39 |



ASME B107.1



1/2" DRIVE UNIVERSAL SOCKETS - 12 POINT

- › Proto® 12 Point Sockets are ideal for use on stubborn or damaged fasteners, and also on fasteners made from soft materials.
- › TorquePlus™ features apply.



| Product # | Size (in) (A) | Nut End Outside Dia. (in) (B) | Drive End Outside Dia. (in) (C) | Nut Depth (in) (D) | Bolt Clearance Depth (in) (E) | Overall Length (in) (L) | Weight (lbs) |
|---------------|---------------|-------------------------------|---------------------------------|--------------------|-------------------------------|-------------------------|--------------|
| J5475A | 1/2 | 23/32 | 15/16 | 3/8 | 29/64 | 2-15/32 | 0.25 |
| J5476A | 9/16 | 13/16 | 15/16 | 13/32 | 1/2 | 2-21/32 | 0.26 |
| J5477A | 5/8 | 15/16 | 15/16 | 29/64 | 1/2 | 2-21/32 | 0.27 |



1/2" DRIVE SPARK PLUG SOCKETS - 6 POINT

- › With rubber insert.
- › Proto® 6 Point Sockets are ideal for use on stubborn or damaged fasteners, and also on fasteners made from soft materials.
- › TorquePlus™ features apply.



| Product # | Size (in) (A) | Overall Length (in) (L) | Weight (lbs) |
|-----------------|---------------|-------------------------|--------------|
| J5320-50 | 5/8 | 2-1/2 | 0.23 |
| J5326HPA | 13/16 | 2-47/64 | 0.35 |



ASME B107.34

1/2" DRIVE DRAG LINK SOCKETS

- › Made of heat-treated alloy steel.
- › Ball detent.

| Product # | Size (in) | Tip Width (in) | Overall Length (in) | Weight (lbs) |
|---------------|-----------|----------------|---------------------|--------------|
| J5444A | 3/4 | 0.115 | 1-5/8 | 0.14 |
| J5446A | 15/16 | 0.154 | 1-5/8 | 0.17 |





1/2" DRIVE SLOTTED SCREWDRIVER BIT SOCKETS

- › Made of heat-treated alloy steel.
- › Ball detent.

| Product # | Tip Size | Tip Thick. (in) | Overall Length (in) | Weight (lbs) |
|---------------|----------|-----------------|---------------------|--------------|
| J5407A | 7/16 | 3/64 | 3-5/32 | 0.20 |
| J5408A | 1/2 | 5/64 | 3-5/32 | 0.22 |
| J5409A | 5/8 | 3/32 | 3-5/32 | 0.27 |



1/2" DRIVE PHILLIPS® SCREWDRIVER BIT SOCKETS

- › Bit holders have a hex opening to hold the bit allowing the bit holder to take the full load of torque.
- › Made of heat-treated alloy steel.
- › Polished chrome finish.

| Product # | Tip Size | Tip Width (in) | Overall Length (in) | Weight (lbs) |
|--------------|----------|----------------|---------------------|--------------|
| J5402 | #2 | 2-5/32 | 2-5/32 | 0.19 |
| J5403 | #3 | 2-5/32 | 2-5/32 | 0.18 |
| J5404 | #4 | 2-5/32 | 2-5/32 | 0.19 |



1/2" DRIVE HEX BIT SOCKETS

- › Bit holders have a hex opening to hold the bit allowing the bit holder to take the full load of torque.
- › Made of heat-treated alloy steel.
- › Polished chrome finish.

| Product # | Size (in) | Bit Length (in) | Overall Length (in) | Weight (lbs) |
|------------------|-----------|-----------------|---------------------|--------------|
| J54411/4 | 1/4 | 1-3/4 | 3-1/4 | 0.19 |
| J54415/16 | 5/16 | 1-3/4 | 3-1/4 | 0.22 |
| J54413/8 | 3/8 | 1-3/4 | 3-1/4 | 0.25 |
| J54417/16 | 7/16 | 1-3/4 | 3-1/4 | 0.28 |
| J54411/2 | 1/2 | 1-7/8 | 3-5/8 | 0.46 |
| J54419/16 | 9/16 | 1-7/8 | 3-5/8 | 0.50 |
| J54415/8 | 5/8 | 2 | 4 | 0.85 |
| J54413/4 | 3/4 | 2 | 4 | 0.92 |





1/2" DRIVE EXTRA-LONG HEX BIT SOCKETS

- › Bit holders have a hex opening to hold the bit allowing the bit holder to take the full load of torque.
- › Made of heat-treated alloy steel.
- › Polished chrome finish.

| Product # | Size (in) | Bit Length (in) | Overall Length (in) | Weight (lbs) |
|-------------|-----------|-----------------|---------------------|--------------|
| J54411/4XL | 1/4 | 3-1/8 | 4-5/8 | 0.20 |
| J54415/16XL | 5/16 | 4-1/8 | 5-5/8 | 0.29 |
| J54413/8XL | 3/8 | 4-1/8 | 5-5/8 | 0.42 |
| J54411/2XL | 1/2 | 5-3/8 | 7-1/8 | 0.60 |
| J54419/16XL | 9/16 | 5-3/8 | 7-1/8 | 0.77 |
| J54415/8XL | 5/8 | 5-3/16 | 7-3/16 | 0.86 |



1/2" DRIVE METRIC HEX BIT SOCKETS

METRIC

| Product # | Size (mm) | Bit Length (in) | Overall Length (in) | Weight (lbs) |
|-----------|-----------|-----------------|---------------------|--------------|
| J5441-6M | 6 | 1-3/4 | 3-1/4 | 0.20 |
| J5441-8M | 8 | 1-3/4 | 3-1/4 | 0.22 |
| J5441-10M | 10 | 1-3/4 | 3-1/4 | 0.26 |
| J5441-12M | 12 | 1-3/4 | 3-1/4 | 0.29 |
| J5441-13M | 13 | 1-7/8 | 3-41/64 | 0.46 |
| J5441-14M | 14 | 1-7/8 | 3-41/64 | 0.50 |
| J5441-15M | 15 | 1-7/8 | 3-41/64 | 0.50 |
| J5441-17M | 17 | 2 | 4 | 0.87 |
| J5441-18M | 18 | 2 | 4 | 0.90 |
| J5441-19M | 19 | 2 | 4 | 0.94 |



- › Bit holders have a hex opening to hold the bit allowing the bit holder to take the full load of torque.
- › Made of heat-treated alloy steel.
- › Polished chrome finish.



1/2" DRIVE METRIC EXTRA-LONG HEX BIT SOCKETS

METRIC

- › Bit holders have a hex opening to hold the bit allowing the bit holder to take the full load of torque.
- › Made of heat-treated alloy steel.
- › Polished chrome finish.

| Product # | Size (mm) | Bit Length (in) | Overall Length (in) | Weight (lbs) |
|-------------|-----------|-----------------|---------------------|--------------|
| J5441-12MXL | 12 | 5-5/8 | 7-1/8 | 0.50 |
| J5441-14MXL | 14 | 5-3/8 | 7-1/8 | 0.75 |
| J5441-17MXL | 17 | 5-1/8 | 7-1/8 | 1.20 |





1/2" DRIVE CROWFOOT WRENCHES

- › Crowfoot wrenches are used in hard to reach, restricted access situations where a standard wrench or ratchet cannot reach.
- › Anti-Slip Design Open End (ASD).
- › The arched surfaces are designed to spread the contact forces over a greater area and they keep the loads off the corners of the fastener which helps prevent fastener rounding.
- › Broad size range ensures the right tool for the application will be available.
- › Typically used in lower torque applications.
- › Full Polish finish provides corrosion resistance and easy to clean surfaces.
- › Locking hole feature helps keep the crowfoot wrench engaged on the extension during use reducing downtime due to detachment of crowfoot in awkward spaces.
- › Use with locking extensions to reach into spaces too small for a mechanic's arm or where the fastener is out of site.



| Product # | Size (in) | Overall Length (in) | Weight (lbs) |
|-----------|-----------|---------------------|--------------|
| J5330CF | 15/16 | 2-13/16 | 0.47 |
| J5332CF | 1 | 2-13/16 | 0.46 |
| J5334CF | 1-1/16 | 2-7/8 | 0.51 |
| J5336CF | 1-1/8 | 3 | 0.54 |
| J5338CF | 1-3/16 | 3 | 0.58 |
| J5340CF | 1-1/4 | 3-5/16 | 0.66 |
| J5342CF | 1-5/16 | 3-5/16 | 0.66 |
| J5344CF | 1-3/8 | 3-3/8 | 0.72 |
| J5346CF | 1-7/16 | 3-3/8 | 0.75 |
| J5348CF | 1-1/2 | 3-7/16 | 0.77 |
| J5350CF | 1-9/16 | 3-1/2 | 0.80 |
| J5352CF | 1-5/8 | 3-1/2 | 0.83 |
| J5354CF | 1-11/16 | 3-13/16 | 0.95 |
| J5356CF | 1-3/4 | 3-13/16 | 0.98 |
| J5358CF | 1-13/16 | 3-7/8 | 1.01 |
| J5360CF | 1-7/8 | 3-7/8 | 1.05 |
| J5364CF | 2 | 3-15/16 | 1.10 |
| J5368CF | 2-1/8 | 4-1/16 | 1.09 |
| J5372CF | 2-1/4 | 4-3/8 | 1.27 |
| J5376CF | 2-3/8 | 4-7/16 | 1.29 |
| J5378CF | 2-7/16 | 4-7/16 | 1.28 |
| J5380CF | 2-1/2 | 4-1/2 | 1.25 |



ASME B107.21

1/2" DRIVE FLARE NUT CROWFOOT WRENCHES

- › Designed for speed and safety.
- › Special heat-treated alloy steel helps increase strength and durability.
- › 12 Point Box end allows for fine indexing, helping to improve speed and access. Fits 4, 6 and 12 point fasteners.
- › Full Polish finish provides corrosion resistance and easy to clean surfaces.



| Product # | Size (in) | Overall Length (in) | Weight (lbs) |
|-----------|-----------|---------------------|--------------|
| J5336FL | 1-1/8 | 2-13/16 | 0.19 |
| J5338FL | 1-3/16 | 2-7/8 | 0.19 |
| J5340FL | 1-1/4 | 3 | 0.19 |
| J5342FL | 1-5/16 | 3-1/16 | 0.19 |
| J5344FL | 1-3/8 | 3-5/16 | 0.25 |
| J5346FL | 1-7/16 | 3-3/8 | 0.25 |
| J5348FL | 1-1/2 | 3-7/16 | 0.25 |
| J5350FL | 1-9/16 | 3-9/16 | 0.31 |
| J5352FL | 1-5/8 | 3-3/4 | 0.31 |
| J5354FL | 1-11/16 | 3-13/16 | 0.31 |
| J5356FL | 1-3/4 | 3-7/8 | 0.38 |
| J5358FL | 1-13/16 | 4 | 0.38 |
| J5360FL | 1-7/8 | 4-1/4 | 0.45 |
| J5362FL | 1-15/16 | 4-5/16 | 0.50 |
| J5364FL | 2 | 4-7/16 | 0.50 |



ASME B107.21



3/4" DRIVE 42 PIECE COMBINATION SOCKET SET - 12 AND 6 POINT

Product #: **J55106**

- ▶ 6 Point Deep: 7/8, 15/16, 1, 1-1/16, 1-1/8, 1-1/4, 1-5/16, 1-3/8, 1-7/16, 1-1/2, 1-5/8 Inch.
- ▶ 12 Point Standard: 3/4, 13/16, 7/8, 15/16, 1, 1-1/16, 1-1/8, 1-3/16, 1-1/4, 1-5/16, 1-3/8, 1-7/16, 1-1/2, 1-9/16, 1-5/8, 1-11/16, 1-3/4, 1-13/16, 1-7/8, 2, 2-1/8, 2-3/16, 2-1/4, 2-3/8 Inch.
- ▶ Accessories: Pear Head Ratchet, 4, 8, and 16 Inch Extensions, Hinge Handle, Universal Joint, Sliding T-Handle, and Metal Box.
- ▶ Weight (lbs): 92.35



| Contents | Description | ASME Spec. | AS Spec. |
|----------|--|---------------|----------|
| J5524 | Socket, 3/4" DR 3/4" 12 PT | ASME B107.1 | |
| J5526 | Socket, 3/4" DR 13/16" 12 PT | ASME B107.1 | |
| J5528 | Socket, 3/4" DR 7/8" 12 PT | ASME B107.1 | |
| J5530 | Socket, 3/4" DR 15/16" 12 PT | ASME B107.1 | |
| J5532 | Socket, 3/4" DR 1" 12 PT | ASME B107.1 | |
| J5534 | Socket, 3/4" DR 1-1/16" 12 PT | ASME B107.1 | |
| J5536 | Socket, 3/4" DR 1-1/8" 12 PT | ASME B107.1 | |
| J5538 | Socket, 3/4" DR 1-3/16" 12 PT | ASME B107.1 | |
| J5540 | Socket, 3/4" DR 1-1/4" 12 PT | ASME B107.1 | |
| J5542 | Socket, 3/4" DR 1-5/16" 12 PT | ASME B107.1 | |
| J5544 | Socket, 3/4" DR 1-3/8" 12 PT | ASME B107.1 | |
| J5546 | Socket, 3/4" DR 1-7/16" 12 PT | ASME B107.1 | |
| J5548 | Socket, 3/4" DR 1-1/2" 12 PT | ASME B107.1 | |
| J5550 | Socket, 3/4" DR 1-9/16" 12 PT | ASME B107.1 | |
| J5552 | Socket, 3/4" DR 1-5/8" 12 PT | ASME B107.1 | |
| J5554 | Socket, 3/4" DR 1-11/16" 12 PT | ASME B107.1 | |
| J5556 | Socket, 3/4" DR 1-3/4" 12 PT | ASME B107.1 | |
| J5558 | Socket, 3/4" DR 1-13/16" 12 PT | ASME B107.1 | |
| J5560 | Socket, 3/4" DR 1-7/8" 12 PT | ASME B107.1 | |
| J5564 | Socket, 3/4" DR 2" 12 PT | ASME B107.1 | |
| J5568 | Socket, 3/4" DR 2-1/8" 12 PT | ASME B107.1 | |
| J5570 | Socket, 3/4" DR 2-3/16" 12 PT | ASME B107.1 | |
| J5572 | Socket, 3/4" DR 2-1/4" 12 PT | ASME B107.1 | |
| J5576 | Socket, 3/4" DR 2-3/8" 12 PT | ASME B107.1 | |
| J5528HL | Socket, 3/4" DR 6 PT Deep 7/8" | ASME B107.1 | |
| J5530HL | Socket, 3/4" DR 6 PT Deep 15/16" | ASME B107.1 | |
| J5532HL | Socket, 3/4" DR 6 PT Deep 1" | ASME B107.1 | |
| J5534HL | Socket, 3/4" DR 6 PT Deep 1-1/16" | ASME B107.1 | |
| J5536HL | Socket, 3/4" DR 6 PT Deep 1-1/8" | ASME B107.1 | |
| J5540HL | Socket, 3/4" DR 6 PT Deep 1-1/4" | ASME B107.1 | |
| J5542HL | Socket, 3/4" DR 6 PT Deep 1-5/16" | ASME B107.1 | |
| J5544HL | Socket, 3/4" DR 6 PT Deep 1-3/8" | ASME B107.1 | |
| J5546HL | Socket, 3/4" DR 6 PT Deep 1-7/16" | ASME B107.1 | |
| J5548HL | Socket, 3/4" DR 8 PT Deep 1-1/2" | ASME B107.1 | |
| J5552HL | Socket, 3/4" DR 6 PT Deep 1-5/8" | ASME B107.1 | |
| J5649 | Ratchet, 3/4" DR Standard Length Classic Pear Head 20" | ASME B107.500 | |
| J5660 | Extension, 3/4" DR 4" | ASME B107.500 | AS 4283 |
| J5661 | Extension, 3/4" DR 8" | ASME B107.500 | AS 4283 |
| J5663 | Extension, 3/4" DR 16" | ASME B107.500 | AS 4283 |
| J5668 | Handle, Hinge 3/4" DR 20" | ASME B107.500 | AS 4283 |
| J5670 | Universal Joint, 3/4" DR 4" | ASME B107.500 | AS 4283 |
| J5685 | Handle, Sliding T 3/4" DR 20" | ASME B107.500 | |
| J5697 | Extra Heavy-Duty Set Box | | |



3/4" DRIVE 29 PIECE METRIC SOCKET SET - 12 POINT

METRIC

Product #: J55104

- › 12 Point Standard: 7/8, 15/16, 1, 1-1/16, 1-1/8, 1-3/16, 1-1/4, 1-5/16, 1-3/8, 1-7/16, 1-1/2, 1-9/16, 1-5/8, 1-11/16, 1-3/4, 1-13/16, 1-7/8, 2, 2-1/8, 2-3/16, 2-1/4, 2-3/8 Inch.
- › Accessories: Pear Head Ratchet, 4, 8, and 16 Inch Extensions, 20 Inch Hinge Handle, Universal Joint, Sliding T-Handle, and Metal Box.
- › Weight (lbs): 69.40



| Contents | Description | ASME Spec. | AS Spec. |
|----------|--|---------------|----------|
| J5528 | Socket, 3/4" DR 7/8" 12 PT | ASME B107.1 | |
| J5530 | Socket, 3/4" DR 15/16" 12 PT | ASME B107.1 | |
| J5532 | Socket, 3/4" DR 1" 12 PT | ASME B107.1 | |
| J5534 | Socket, 3/4" DR 1-1/16" 12 PT | ASME B107.1 | |
| J5536 | Socket, 3/4" DR 1-1/8" 12 PT | ASME B107.1 | |
| J5538 | Socket, 3/4" DR 1-3/16" 12 PT | ASME B107.1 | |
| J5540 | Socket, 3/4" DR 1-1/4" 12 PT | ASME B107.1 | |
| J5542 | Socket, 3/4" DR 1-5/16" 12 PT | ASME B107.1 | |
| J5544 | Socket, 3/4" DR 1-3/8" 12 PT | ASME B107.1 | |
| J5546 | Socket, 3/4" DR 1-7/16" 12 PT | ASME B107.1 | |
| J5548 | Socket, 3/4" DR 1-1/2" 12 PT | ASME B107.1 | |
| J5550 | Socket, 3/4" DR 1-9/16" 12 PT | ASME B107.1 | |
| J5552 | Socket, 3/4" DR 1-5/8" 12 PT | ASME B107.1 | |
| J5554 | Socket, 3/4" DR 1-11/16" 12 PT | ASME B107.1 | |
| J5556 | Socket, 3/4" DR 1-3/4" 12 PT | ASME B107.1 | |
| J5558 | Socket, 3/4" DR 1-13/16" 12 PT | ASME B107.1 | |
| J5560 | Socket, 3/4" DR 1-7/8" 12 PT | ASME B107.1 | |
| J5564 | Socket, 3/4" DR 2" 12 PT | ASME B107.1 | |
| J5568 | Socket, 3/4" DR 2-1/8" 12 PT | ASME B107.1 | |
| J5570 | Socket, 3/4" DR 2-3/16" 12 PT | ASME B107.1 | |
| J5572 | Socket, 3/4" DR 2-1/4" 12 PT | ASME B107.1 | |
| J5576 | Socket, 3/4" DR 2-3/8" 12 PT | ASME B107.1 | |
| J5649 | Ratchet, 3/4" DR Standard Length Classic Pear Head 20" | ASME B107.500 | |
| J5660 | Extension, 3/4" DR 4" | ASME B107.500 | AS 4283 |
| J5661 | Extension, 3/4" DR 8" | ASME B107.500 | AS 4283 |
| J5663 | Extension, 3/4" DR 16" | ASME B107.500 | AS 4283 |
| J5668 | Handle, Hinge 3/4" DR 20" | ASME B107.500 | AS 4283 |
| J5670 | Universal Joint, 3/4" DR 4" | ASME B107.500 | AS 4283 |
| J5685 | Handle, Sliding T 3/4" DR 20" | ASME B107.500 | |
| J5696 | Extra Heavy-Duty Set Box | | |



3/4" DRIVE 28 PIECE METRIC SOCKET SET - 12 POINT



Product #: J55202

- › 12 Point Standard: 21, 22, 23, 24, 25, 26, 27, 28, 29, 30, 32, 35, 36, 38, 41, 42, 46, 50, 54, 55, 58, 60 mm.
- › Accessories: Pear Head Ratchet, 4 and 8 Inch Extensions, 20 Inch Hinge Handle, Universal Joint, Sliding T-Handle, and Metal Box.
- › Weight (lbs): 67.48



| Contents | Description | ASME Spec. | AS Spec. |
|----------|--|---------------|----------|
| J5521M | Socket, 3/4" DR 21 mm 12 PT | ASME B107.5M | |
| J5522M | Socket, 3/4" DR 22 mm 12 PT | ASME B107.5M | |
| J5523M | Socket, 3/4" DR 23 mm 12 PT | ASME B107.5M | |
| J5524M | Socket, 3/4" DR 24 mm 12 PT | ASME B107.5M | |
| J5525M | Socket, 3/4" DR 25 mm 12 PT | ASME B107.5M | |
| J5526M | Socket, 3/4" DR 26 mm 12 PT | ASME B107.5M | |
| J5527M | Socket, 3/4" DR 27 mm 12 PT | ASME B107.5M | |
| J5528M | Socket, 3/4" DR 28 mm 12 PT | ASME B107.5M | |
| J5529M | Socket, 3/4" DR 29 mm 12 PT | ASME B107.5M | |
| J5530M | Socket, 3/4" DR 30 mm 12 PT | ASME B107.5M | |
| J5532M | Socket, 3/4" DR 32 mm 12 PT | ASME B107.5M | |
| J5535M | Socket, 3/4" DR 35 mm 12 PT | ASME B107.5M | |
| J5536M | Socket, 3/4" DR 36 mm 12 PT | ASME B107.5M | |
| J5538M | Socket, 3/4" DR 38 mm 12 PT | ASME B107.5M | |
| J5541M | Socket, 3/4" DR 41 mm 12 PT | ASME B107.5M | |
| J5542M | Socket, 3/4" DR 42 mm 12 PT | ASME B107.5M | |
| J5546M | Socket, 3/4" DR 46 mm 12 PT | ASME B107.5M | |
| J5550M | Socket, 3/4" DR 50 mm 12 PT | ASME B107.5M | |
| J5554M | Socket, 3/4" DR 54 mm 12 PT | ASME B107.5M | |
| J5555M | Socket, 3/4" DR 55 mm 12 PT | ASME B107.5M | |
| J5558M | Socket, 3/4" DR 58 mm 12 PT | ASME B107.5M | |
| J5560M | Socket, 3/4" DR 60 mm 12 PT | ASME B107.5M | |
| J5649 | Ratchet, 3/4" DR Standard Length Classic Pear Head 20" | ASME B107.500 | |
| J5660 | Extension, 3/4" DR 4" | ASME B107.500 | AS 4283 |
| J5661 | Extension, 3/4" DR 8" | ASME B107.500 | AS 4283 |
| J5668 | Handle, Hinge 3/4" DR 20" | ASME B107.500 | AS 4283 |
| J5670 | Universal Joint, 3/4" DR 4" | ASME B107.500 | AS 4283 |
| J5685 | Handle, Sliding T 3/4" DR 20" | ASME B107.500 | |
| J5696 | Extra Heavy-Duty Set Box | | |



3/4" DRIVE 20 PIECE SOCKET SET - 12 POINT

Product #: J55102

- › 12 Point Standard: 7/8, 15/16, 1, 1-1/16, 1-1/8, 1-1/4, 1-5/16, 1-3/8, 1-7/16, 1-1/2, 1-5/8, 1-3/4, 1-13/16, 1-7/8, 2 Inch.
- › Accessories: Pear Head Ratchet, 8 and 16 Inch Extensions, 20 Inch Hinge Handle, Sliding T-Handle, and Metal Box.
- › Weight (lbs): 57.12



| Contents | Description | ASME Spec. | AS Spec. |
|----------|--|---------------|----------|
| J5528 | Socket, 3/4" DR 7/8" 12 PT | ASME B107.1 | |
| J5530 | Socket, 3/4" DR 15/16" 12 PT | ASME B107.1 | |
| J5532 | Socket, 3/4" DR 1" 12 PT | ASME B107.1 | |
| J5534 | Socket, 3/4" DR 1-1/16" 12 PT | ASME B107.1 | |
| J5536 | Socket, 3/4" DR 1-1/8" 12 PT | ASME B107.1 | |
| J5540 | Socket, 3/4" DR 1-1/4" 12 PT | ASME B107.1 | |
| J5542 | Socket, 3/4" DR 1-5/16" 12 PT | ASME B107.1 | |
| J5544 | Socket, 3/4" DR 1-3/8" 12 PT | ASME B107.1 | |
| J5546 | Socket, 3/4" DR 1-7/16" 12 PT | ASME B107.1 | |
| J5548 | Socket, 3/4" DR 1-1/2" 12 PT | ASME B107.1 | |
| J5552 | Socket, 3/4" DR 1-5/8" 12 PT | ASME B107.1 | |
| J5556 | Socket, 3/4" DR 1-3/4" 12 PT | ASME B107.1 | |
| J5558 | Socket, 3/4" DR 1-13/16" 12 PT | ASME B107.1 | |
| J5560 | Socket, 3/4" DR 1-7/8" 12 PT | ASME B107.1 | |
| J5564 | Socket, 3/4" DR 2" 12 PT | ASME B107.1 | |
| J5649 | Ratchet, 3/4" DR Standard Length Classic Pear Head 20" | ASME B107.500 | |
| J5661 | Extension, 3/4" DR 8" | ASME B107.500 | AS 4283 |
| J5663 | Extension, 3/4" DR 16" | ASME B107.500 | AS 4283 |
| J5668 | Handle, Hinge 3/4" DR 20" | ASME B107.500 | AS 4283 |
| J5685 | Handle, Sliding T 3/4" DR 20" | ASME B107.500 | |
| J5696 | Extra Heavy-Duty Set Box | | |

3/4" DRIVE 19 PIECE METRIC SOCKET SET - 12 POINT

METRIC

Product #: J55200

- › 12 Point Standard: 24, 25, 26, 27, 28, 29, 30, 31, 32, 35, 36, 38, 41, 42, 46 mm.
- › Accessories: Pear Head Ratchet, 8 and 16 Inch Extensions, 20 Inch Hinge Handle, and Metal Box.
- › Weight (lbs): 39.60



| Contents | Description | ASME Spec. | AS Spec. |
|----------|--|---------------|----------|
| J5524M | Socket, 3/4" DR 24 mm 12 PT | ASME B107.5M | |
| J5525M | Socket, 3/4" DR 25 mm 12 PT | ASME B107.5M | |
| J5526M | Socket, 3/4" DR 26 mm 12 PT | ASME B107.5M | |
| J5527M | Socket, 3/4" DR 27 mm 12 PT | ASME B107.5M | |
| J5528M | Socket, 3/4" DR 28 mm 12 PT | ASME B107.5M | |
| J5529M | Socket, 3/4" DR 29 mm 12 PT | ASME B107.5M | |
| J5530M | Socket, 3/4" DR 30 mm 12 PT | ASME B107.5M | |
| J5531M | Socket, 3/4" DR 31 mm 12 PT | ASME B107.5M | |
| J5532M | Socket, 3/4" DR 32 mm 12 PT | ASME B107.5M | |
| J5535M | Socket, 3/4" DR 35 mm 12 PT | ASME B107.5M | |
| J5536M | Socket, 3/4" DR 36 mm 12 PT | ASME B107.5M | |
| J5538M | Socket, 3/4" DR 38 mm 12 PT | ASME B107.5M | |
| J5541M | Socket, 3/4" DR 41 mm 12 PT | ASME B107.5M | |
| J5542M | Socket, 3/4" DR 42 mm 12 PT | ASME B107.5M | |
| J5546M | Socket, 3/4" DR 46 mm 12 PT | ASME B107.5M | |
| J5649 | Ratchet, 3/4" DR Standard Length Classic Pear Head 20" | ASME B107.500 | |
| J5661 | Extension, 3/4" DR 8" | ASME B107.500 | AS 4283 |
| J5663 | Extension, 3/4" DR 16" | ASME B107.500 | AS 4283 |
| J5668 | Handle, Hinge 3/4" DR 20" | ASME B107.500 | AS 4283 |
| J5695 | Extra Heavy-Duty Set Box | | |

3/4" DRIVE 13 PIECE SOCKET SET - 12 POINT

Product #: J55100

- › 12 Point Standard: 7/8, 15/16, 1, 1-1/16, 1-1/8, 1-3/16, 1-1/4, 1-5/16, 1-3/8, 1-7/16, and 1-1/2 Inch.
- › Accessories: Pear Head Ratchet, 8 Inch Extension, and Metal Box.
- › Weight (lbs): 27.97



| Contents | Description | ASME Spec. | AS Spec. |
|----------|--|---------------|----------|
| J5528 | Socket, 3/4" DR 7/8" 12 PT | ASME B107.1 | |
| J5530 | Socket, 3/4" DR 15/16" 12 PT | ASME B107.1 | |
| J5532 | Socket, 3/4" DR 1" 12 PT | ASME B107.1 | |
| J5534 | Socket, 3/4" DR 1-1/16" 12 PT | ASME B107.1 | |
| J5536 | Socket, 3/4" DR 1-1/8" 12 PT | ASME B107.1 | |
| J5538 | Socket, 3/4" DR 1-3/16" 12 PT | ASME B107.1 | |
| J5540 | Socket, 3/4" DR 1-1/4" 12 PT | ASME B107.1 | |
| J5542 | Socket, 3/4" DR 1-5/16" 12 PT | ASME B107.1 | |
| J5544 | Socket, 3/4" DR 1-3/8" 12 PT | ASME B107.1 | |
| J5546 | Socket, 3/4" DR 1-7/16" 12 PT | ASME B107.1 | |
| J5548 | Socket, 3/4" DR 1-1/2" 12 PT | ASME B107.1 | |
| J5649 | Ratchet, 3/4" DR Standard Length Classic Pear Head 20" | ASME B107.500 | |
| J5661 | Extension, 3/4" DR 8" | ASME B107.500 | AS 4283 |
| J5694 | Extra Heavy-Duty Set Box | | |





3/4" DRIVE STANDARD LENGTH CLASSIC PEAR HEAD RATCHETS

- › Robust 24-tooth gear/floating pawl design provides 15° ratcheting angle while maximizing ultimate torque.
- › Thin head design for access into tight work areas.
- › Reversing lever designed for quick, one-hand operation.

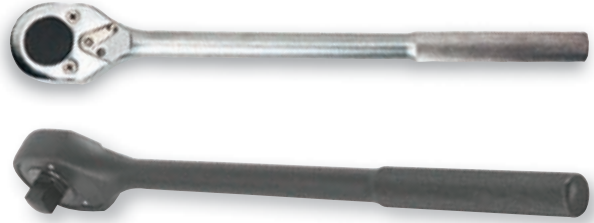

| Product # | Drive Size (in) | Finish | Overall Length (in) | Weight (lbs) | Repair Kit |
|----------------|-----------------|-------------|---------------------|--------------|------------|
| J5649 | 3/4 | Full Polish | 20 | 6.00 | J5649RK |
| J5649BL | 3/4 | Black Oxide | 20 | 6.00 | J5649RK |



ASME B107.500

3/4" DRIVE FEMALE DRIVE RATCHET

- › Robust 24-tooth gear design provides 15° ratcheting angle while maximizing torque.
- › Thin head design for access into tight work spaces.
- › Reversing lever designed for quick, one-hand operation.
- › Satin finish.



| Product # | Drive Size (in) | Finish | Overall Length (in) | Weight (lbs) | Repair Kit |
|----------------|-----------------|--------|---------------------|--------------|------------|
| J5649FW | 3/4 | Satin | 20 | 5.62 | J5649FWRK |



ASME B107.500

3/4" DRIVE RATCHET ADAPTERS

- › Converts standard handles to ratcheting handles.
- › Made from alloy steel.
- › Heat-treated for strength and durability.
- › Chrome plated.
- › Male/Female.



| Product # | Drive Size (in) | Finish | Overall Length (in) | Weight (lbs) |
|--------------|-----------------|-------------|---------------------|--------------|
| J5647 | 3/4 | Full Polish | 3-3/4 | 2.38 |



ASME B107.500

3/4" DRIVE HINGE HANDLES

- › The head can flex plus or minus 90° from horizontal.

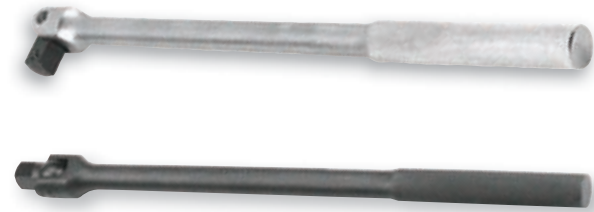

| Product # | Drive Size (in) | Finish | Overall Length (in) | Weight (lbs) |
|----------------|-----------------|-------------|---------------------|--------------|
| J5668 | 3/4 | Full Polish | 20 | 4.32 |
| J5668BL | 3/4 | Black Oxide | 20 | 4.41 |



ASME B107.500

3/4" DRIVE SLIDING T-HANDLE

- › Made from alloy steel.
- › Heat-treated for strength and durability.



| Product # | Drive Size (in) | Finish | Overall Length (in) | Weight (lbs) |
|--------------|-----------------|-------------|---------------------|--------------|
| J5685 | 3/4 | Full Polish | 20 | 2.95 |



ASME B107.500



3/4" DRIVE ELL HANDLE

- › Satin finish.

| Product # | Drive Size (in) | Finish | Overall Length (in) | Weight (lbs) |
|--------------|-----------------|--------|---------------------|--------------|
| J5686 | 3/4 | Satin | 16 | 3.96 |



3/4" DRIVE STANDARD EXTENSIONS

| Product # | Drive Size (in) | Finish | Overall Length (in) | Weight (lbs) |
|--------------|-----------------|-------------|---------------------|--------------|
| J5660 | 3/4 | Full Polish | 4 | 0.88 |
| J5661 | 3/4 | Full Polish | 8 | 1.80 |
| J5663 | 3/4 | Full Polish | 16 | 2.36 |



ASME B107.500



3/4" DRIVE DRIVE ADAPTERS

| Product # | Drive Size (in) | Finish | Overall Length (in) | Weight (lbs) |
|--------------|-----------------|-------------|---------------------|--------------|
| J5653 | 1/2 | Full Polish | 1-11/16 | 0.24 |
| J5453 | 1/2 | Full Polish | 1-7/8 | 0.39 |
| J5853 | 1 | Full Polish | 2-1/2 | 0.82 |
| J5854 | 1 | Full Polish | 2-7/8 | 1.27 |



ASME B107.500



3/4" DRIVE UNIVERSAL JOINT

| Product # | Drive Size (in) | Finish | Overall Length (in) | Weight (lbs) |
|--------------|-----------------|-------------|---------------------|--------------|
| J5670 | 3/4 | Full Polish | 4 | 1.03 |



ASME B107.500



3/4" DRIVE DEEP SOCKETS - 6 POINT

- › Proto® 6 Point Sockets are ideal for use on stubborn or damaged fasteners, and also on fasteners made from soft materials.
- › Made from alloy steel.
- › Heat-treated for strength and durability.
- › Hand use only.
- › Ball detent design.
- › TorquePlus™ features apply.



| Product # | Size | | Nut End | | Drive End | | Nut Depth (in) (D) | Bolt Clearance Depth (in) (E) | Overall Length (in) (L) | Weight (lbs) |
|----------------|----------|-----------------------|-----------------------|-----------------------|-----------------------|----------------|--------------------|-------------------------------|-------------------------|--------------|
| | (in) (A) | Outside Dia. (in) (B) | Outside Dia. (in) (B) | Outside Dia. (in) (C) | Outside Dia. (in) (C) | Depth (in) (D) | | | | |
| J5528HL | 7/8 | | 1-3/8 | | 1-3/8 | | 9/16 | 2-9/16 | 3-1/2 | 0.91 |
| J5530HL | 15/16 | | 1-7/16 | | 1-7/16 | | 9/16 | 2-9/16 | 3-1/2 | 0.80 |
| J5532HL | 1 | | 1-1/2 | | 1-1/2 | | 5/8 | 2-9/16 | 3-1/2 | 1.11 |
| J5534HL | 1-1/16 | | 1-9/16 | | 1-7/16 | | 11/16 | 2-9/16 | 3-1/2 | 0.97 |
| J5536HL | 1-1/8 | | 1-19/32 | | 1-1/2 | | 25/32 | 2-3/8 | 3-1/2 | 1.12 |
| J5540HL | 1-1/4 | | 1-13/16 | | 1-21/32 | | 13/16 | 2-11/32 | 3-1/2 | 1.28 |
| J5542HL | 1-5/16 | | 1-55/64 | | 1-21/32 | | 27/32 | 2-19/64 | 3-1/2 | 1.32 |
| J5544HL | 1-3/8 | | 1-55/64 | | 1-21/32 | | 29/32 | 2-9/32 | 3-1/2 | 1.64 |
| J5546HL | 1-7/16 | | 2-1/16 | | 1-21/32 | | 61/64 | 2-1/4 | 3-1/2 | 1.65 |
| J5548HL | 1-1/2 | | 2-1/16 | | 1-1/32 | | 1 | 2-1/4 | 3-1/2 | 1.65 |
| J5552HL | 1-5/8 | | 2-1/4 | | 1-3/4 | | 1-7/64 | 2-13/64 | 3-1/2 | 1.52 |



ASME B107.1



3/4" DRIVE SOCKETS - 12 POINT

- › Proto® 12 Point Sockets are ideal for use on stubborn or damaged fasteners, and also on fasteners made from soft materials.
- › Ball detent design.
- › Made of heat-treated alloy steel.
- › Side locking hole.
- › TorquePlus™ features apply.



| Product # | Size (in) (A) | Nut End Outside Dia. (in) (B) | Drive End Outside Dia. (in) (C) | Nut Depth (in) (D) | Bolt Clearance Depth (in) (E) | Overall Length (in) (L) | Weight (lbs) |
|-----------|---------------|-------------------------------|---------------------------------|--------------------|-------------------------------|-------------------------|--------------|
| J5524 | 3/4 | 1-5/16 | 1-5/16 | 19/32 | 1-1/16 | 2 | 0.35 |
| J5526 | 13/16 | 1-5/16 | 1-5/16 | 21/32 | 1-1/16 | 2 | 0.36 |
| J5528 | 7/8 | 1-5/16 | 1-5/16 | 45/64 | 1-1/16 | 2 | 0.46 |
| J5530 | 15/16 | 1-7/16 | 1-7/16 | 3/4 | 1-1/16 | 2 | 0.51 |
| J5532 | 1 | 1-1/2 | 1-1/2 | 3/4 | 1-1/16 | 2 | 0.56 |
| J5534 | 1-1/16 | 1-37/64 | 1-37/64 | 3/4 | 1-1/16 | 2 | 0.61 |
| J5536 | 1-1/8 | 1-37/64 | 1-15/32 | 25/32 | 1 | 2-7/32 | 0.72 |
| J5538 | 1-3/16 | 1-37/64 | 1-15/32 | 25/32 | 1 | 2-7/32 | 0.61 |
| J5540 | 1-1/4 | 1-13/16 | 1-19/32 | 13/16 | 1-5/32 | 2-15/64 | 0.87 |
| J5542 | 1-5/16 | 1-7/8 | 1-19/32 | 27/32 | 1-5/32 | 2-9/32 | 0.89 |
| J5544 | 1-3/8 | 1-7/8 | 1-5/8 | 29/32 | 1-5/32 | 2-9/32 | 0.84 |
| J5546 | 1-7/16 | 2-3/64 | 1-5/8 | 61/64 | 1-1/4 | 2-13/32 | 1.07 |
| J5548 | 1-1/2 | 2-3/64 | 1-5/8 | 1 | 1-1/4 | 2-13/32 | 0.94 |
| J5550 | 1-9/16 | 2-3/16 | 1-23/32 | 1-3/64 | 1-15/16 | 2-5/8 | 0.97 |
| J5552 | 1-5/8 | 2-15/64 | 1-3/4 | 1-7/64 | 1-15/16 | 2-5/8 | 1.03 |
| J5554 | 1-11/16 | 2-3/8 | 1-3/4 | 1-5/32 | 1-15/32 | 2-3/4 | 1.14 |
| J5556 | 1-3/4 | 2-3/8 | 1-3/4 | 1-13/64 | 1-15/32 | 2-3/4 | 1.30 |
| J5558 | 1-13/16 | 2-9/16 | 1-3/4 | 1-1/4 | 1-39/64 | 2-29/32 | 1.41 |
| J5560 | 1-7/8 | 2-9/16 | 1-3/4 | 1-19/64 | 1-39/64 | 2-31/32 | 1.55 |
| J5564 | 2 | 2-47/64 | 2 | 1-3/4 | 1-3/4 | 3-7/64 | 1.59 |
| J5566 | 2-1/16 | 2-49/64 | 2-1/32 | 1-3/4 | 1-3/4 | 3-5/32 | 1.60 |
| J5568 | 2-1/8 | 2-61/64 | 2-3/32 | 1-13/16 | 1-13/16 | 3-9/32 | 1.64 |
| J5570 | 2-3/16 | 2-61/64 | 2-3/32 | 1-13/16 | 2-5/32 | 3-9/32 | 1.90 |
| J5572 | 2-1/4 | 3-17/64 | 2-3/32 | 1-61/64 | 2-3/16 | 3-13/32 | 1.91 |
| J5576 | 2-3/8 | 3-17/64 | 2-29/64 | 2-1/8 | 2-3/16 | 3-43/64 | 2.28 |



ASME B107.1

FEATURES AND BENEFITS —



- › High performance drive configuration allows for quick and easy socket engagement to the fastener flats, not the corners.
- › Employs a radius-corner design, shifting contact area and stress away from the fastener corners and distributing contact stresses over a large area of the socket, minimizing slippage.
- › The internal design minimizes fastener rounding, helps to extend fastener life, and allows the user to more easily turn worn, rounded, or rusted fasteners.

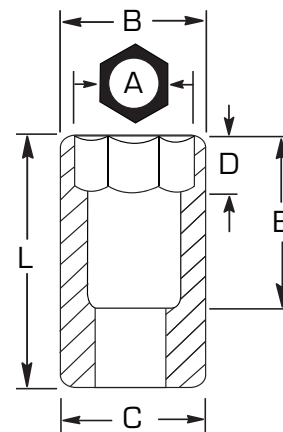



3/4" DRIVE METRIC SOCKETS - 12 POINT



- › Proto® 12 Point Sockets are ideal for use on stubborn or damaged fasteners, and also on fasteners made from soft materials.
- › Ball detent design.
- › TorquePlus™ features apply.



| Product # | Size | | Nut End | | Drive End | | Nut Depth (in) (D) | Bolt Clearance Depth (in) (E) | Overall Length (in) (L) | Weight (lbs) |
|-----------|----------|-----------------------|-----------------------|-----------------------|-----------|--------|--------------------|-------------------------------|-------------------------|--------------|
| | (mm) (A) | Outside Dia. (in) (B) | Outside Dia. (in) (C) | Outside Dia. (in) (C) | | | | | | |
| J5519M | 19 | 1-1/8 | 1-19/64 | 1-19/64 | 9/16 | 1-5/16 | 2 | 0.36 | | |
| J5520M | 20 | 1-3/16 | 1-19/64 | 1-19/64 | 9/16 | 1-5/16 | 2 | 0.37 | | |
| J5521M | 21 | 1-17/64 | 1-19/64 | 1-19/64 | 9/16 | 1-5/16 | 2 | 0.40 | | |
| J5522M | 22 | 1-5/16 | 1-19/64 | 1-19/64 | 9/16 | 1-5/16 | 2 | 0.41 | | |
| J5523M | 23 | 1-13/32 | 1-13/32 | 1-13/32 | 9/16 | 1-5/16 | 2 | 0.52 | | |
| J5524M | 24 | 1-7/16 | 1-7/16 | 1-7/16 | 9/16 | 1-5/16 | 2 | 0.41 | | |
| J5525M | 25 | 1-31/64 | 1-31/64 | 1-31/64 | 5/8 | 1-5/16 | 2 | 0.60 | | |
| J5526M | 26 | 1-1/2 | 1-1/2 | 1-1/2 | 5/8 | 1-5/16 | 2 | 0.59 | | |
| J5527M | 27 | 1-35/64 | 1-35/64 | 1-35/64 | 11/16 | 1-5/16 | 2 | 0.62 | | |
| J5528M | 28 | 1-19/32 | 1-31/64 | 1-31/64 | 3/4 | 1-5/16 | 2-7/32 | 0.64 | | |
| J5529M | 29 | 1-19/32 | 1-31/64 | 1-31/64 | 49/64 | 1-5/16 | 2-7/32 | 0.65 | | |
| J5530M | 30 | 1-19/32 | 1-31/64 | 1-31/64 | 49/64 | 1-5/16 | 2-7/32 | 0.63 | | |
| J5531M | 31 | 1-47/64 | 1-47/64 | 1-47/64 | 13/16 | 1-5/16 | 2-7/32 | 0.72 | | |
| J5532M | 32 | 1-25/32 | 1-31/64 | 1-31/64 | 13/16 | 1-5/16 | 2-7/32 | 0.78 | | |
| J5535M | 35 | 1-55/64 | 1-19/32 | 1-19/32 | 1-5/32 | 1-5/16 | 2-9/32 | 0.87 | | |
| J5536M | 36 | 2-3/64 | 1-19/32 | 1-19/32 | 1-15/64 | 1-5/16 | 2-13/32 | 1.09 | | |
| J5538M | 38 | 2-3/64 | 1-19/32 | 1-19/32 | 1-15/64 | 1-5/16 | 2-13/32 | 1.04 | | |
| J5541M | 41 | 2-15/64 | 1-23/32 | 1-23/32 | 1-9/32 | 1-5/16 | 2-39/64 | 1.06 | | |
| J5542M | 42 | 2-23/64 | 1-23/32 | 1-23/32 | 1-15/32 | 1-5/16 | 2-23/32 | 1.06 | | |
| J5546M | 46 | 2-37/64 | 1-25/32 | 1-25/32 | 1-39/64 | 1-5/16 | 2-31/32 | 1.45 | | |
| J5550M | 50 | 2-49/64 | 2-1/32 | 2-1/32 | 1-47/64 | 1-5/16 | 3-5/32 | 2.39 | | |
| J5554M | 54 | 2-15/16 | 2-3/32 | 2-3/32 | 1-3/8 | 1-5/16 | 3-9/32 | 1.97 | | |
| J5555M | 55 | 2-15/16 | 2-3/32 | 2-3/32 | 1-13/16 | 1-5/16 | 3-9/32 | 2.64 | | |
| J5558M | 58 | 3-9/64 | 2-3/32 | 2-3/32 | 1-61/64 | 1-5/16 | 3-13/32 | 2.99 | | |
| J5560M | 60 | 3-17/64 | 2-17/32 | 2-17/32 | 2-1/8 | 1-5/16 | 3-21/32 | 2.27 | | |



ASME B107.5M

3/4" DRIVE SOCKETS - SPLINE

- › Proto® Spline tools are designed to service high tensile strength fasteners used widely on military and commercial aircraft and in heavy machinery applications where vibration is prevalent. They are also used in automotive and industrial areas where high performance torque needs to be achieved.
- › Spline sockets help tighten high strength bolts to high torque loads. They help lower the force required to turn standard fasteners by allowing the torque load to be moved away from the corners to help prevent fastener rounding. They also turn fasteners with damaged corners.
- › Spline sockets on spline fasteners help deliver twice the torque of 12 pt. wrenches on double box fasteners, and more torque than hex wrenches on hex fasteners.
- › Spline helps reduce foreign object debris (FOD) by having a precise fit between the fastening tool and its fastener.



| Product # | Size | | Nut End | | Drive End | | Nut Depth (in) (D) | Bolt Clearance Depth (in) (E) | Overall Length (in) (L) | Weight (lbs) |
|-----------|----------|-------------|-----------------------|-----------------------|-----------------------|--------|--------------------|-------------------------------|-------------------------|--------------|
| | (in) (A) | Spline Size | Outside Dia. (in) (B) | Outside Dia. (in) (C) | Outside Dia. (in) (C) | | | | | |
| J5524SPL | 3/4 | #24 | 1-3/64 | 1-3/8 | 5/8 | 9/16 | 1-5/8 | 0.30 | | |
| J5526SPL | 13/16 | #26 | 1-3/16 | 1-3/8 | 5/8 | 9/16 | 1-5/8 | 0.36 | | |
| J5528SPL | 7/8 | #28 | 1-5/16 | 1-3/8 | 3/4 | 11/16 | 1-11/16 | 0.33 | | |
| J5530SPL | 15/16 | #30 | 1-3/8 | 1-3/8 | 3/4 | 3/4 | 1-7/8 | 0.36 | | |
| J5532SPL | 1 | #32 | 1-7/16 | 1-7/16 | 13/16 | 1-1/8 | 1-15/16 | 0.45 | | |
| J5534SPL | 1-1/16 | #34 | 1-1/2 | 1-1/2 | 7/8 | 1-3/32 | 1-31/32 | 0.53 | | |



1" DRIVE 29 PIECE SOCKET SET - 12 POINT

Product #: J57104

- ▶ 12 Point Standard: 1-1/16, 1-1/8, 1-3/16, 1-1/4, 1-5/16, 1-3/8, 1-7/16, 1-1/2, 1-5/8, 1-13/16, 1-7/8, 2, 2-3/16, 2-1/4, 2-3/8, 2-1/2, 2-9/16, 2-5/8, 2-3/4, 2-15/16, 3, 3-1/8, 3-1/2 Inch.
- ▶ Accessories: Pear Head Ratchet, 8 and 17 Inch Extensions, 28-1/2 Inch Sliding T-Handle, Sliding Plug, and Metal Box.
- ▶ Weight (lbs): 135.50



| Contents | Description | ASME Spec. | AS Spec. |
|----------|--------------------------------------|---------------|---------------|
| J5734 | Socket, 1" DR 1-1/16" 12 PT | ASME B107.1 | AS954E S3.8.1 |
| J5736 | Socket, 1" DR 1-1/8" 12 PT | ASME B107.1 | AS954E S3.8.1 |
| J5738 | Socket, 1" DR 1-3/16" 12 PT | ASME B107.1 | AS954E S3.8.1 |
| J5740 | Socket, 1" DR 1-1/4" 12 PT | ASME B107.1 | AS954E S3.8.1 |
| J5742 | Socket, 1" DR 1-5/16" 12 PT | ASME B107.1 | AS954E S3.8.1 |
| J5744 | Socket, 1" DR 1-3/8" 12 PT | ASME B107.1 | AS954E S3.8.1 |
| J5746 | Socket, 1" DR 1-7/16" 12 PT | ASME B107.1 | AS954E S3.8.1 |
| J5748 | Socket, 1" DR 1-1/2" 12 PT | ASME B107.1 | AS954E S3.8.1 |
| J5752 | Socket, 1" DR 1-5/8" 12 PT | ASME B107.1 | AS954E S3.8.1 |
| J5758 | Socket, 1" DR 1-13/16" 12 PT | ASME B107.1 | AS954E S3.8.1 |
| J5760 | Socket, 1" DR 1-7/8" 12 PT | ASME B107.1 | AS954E S3.8.1 |
| J5764 | Socket, 1" DR 2" 12 PT | ASME B107.1 | AS954E S3.8.1 |
| J5770 | Socket, 1" DR 2-3/16" 12 PT | ASME B107.1 | AS954E S3.8.1 |
| J5772 | Socket, 1" DR 2-1/4" 12 PT | ASME B107.1 | AS954E S3.8.1 |
| J5776 | Socket, 1" DR 2-3/8" 12 PT | ASME B107.1 | AS954E S3.8.1 |
| J5780 | Socket, 1" DR 2-1/2" 12 PT | ASME B107.1 | AS954E S3.8.1 |
| J5782 | Socket, 1" DR 2-9/16" 12 PT | ASME B107.1 | AS954E S3.8.1 |
| J5784 | Socket, 1" DR 2-5/8" 12 PT | ASME B107.1 | AS954E S3.8.1 |
| J5788 | Socket, 1" DR 2-3/4" 12 PT | ASME B107.1 | AS954E S3.8.1 |
| J5794 | Socket, 1" DR 2-15/16" 12 PT | ASME B107.1 | AS954E S3.8.1 |
| J5796 | Socket, 1" DR 3" 12 PT | ASME B107.1 | AS954E S3.8.1 |
| J5800 | Socket, 1" DR 3-1/8" 12 PT | ASME B107.1 | AS954E S3.8.1 |
| J5812 | Socket, 1" DR 3-1/2" 12 PT | ASME B107.1 | AS954E S3.8.1 |
| J5849 | Ratchet, 1" DR Classic Pear Head 26" | ASME B107.500 | |
| J5861 | Extension, 1" DR 8" | ASME B107.500 | AS 4283 |
| J5863 | Extension, 1" DR 17" | ASME B107.500 | AS 4283 |
| J5868 | Handle, Hinge 1" DR 27" | ASME B107.500 | AS 4283 |
| J5884 | Handle, Sliding T 1" DR 28-1/2" | ASME B107.500 | |
| J5885 | Sliding Drive Plug 1" DR | ASME B107.500 | |
| J5896 | Super Heavy-Duty Set Box | | |



1" DRIVE 22 PIECE SOCKET SET - 12 POINT

Product #: J57102

- › 12 Point Standard: 1-1/2, 1-5/8, 1-13/16, 1-7/8, 2, 2-3/16, 2-1/4, 2-3/8, 2-1/2, 2-9/16, 2-5/8, 2-3/4, 2-15/16, 3, 3-1/8, 3-1/2 Inch.
- › Accessories: Male/Female Ratchet, 8 and 17 Inch Extensions, 27 Inch Hinge Handle, 28-1/2 Inch Sliding T-Handle, Sliding Plug, and Metal Box.
- › Weight (lbs): 129.50



| Contents | Description | ASME Spec. | AS Spec. |
|----------|--------------------------------------|---------------|---------------|
| J5748 | Socket, 1" DR 1-1/2" 12 PT | ASME B107.1 | AS954E S3.8.1 |
| J5752 | Socket, 1" DR 1-5/8" 12 PT | ASME B107.1 | AS954E S3.8.1 |
| J5758 | Socket, 1" DR 1-13/16" 12 PT | ASME B107.1 | AS954E S3.8.1 |
| J5760 | Socket, 1" DR 1-7/8" 12 PT | ASME B107.1 | AS954E S3.8.1 |
| J5764 | Socket, 1" DR 2" 12 PT | ASME B107.1 | AS954E S3.8.1 |
| J5770 | Socket, 1" DR 2-3/16" 12 PT | ASME B107.1 | AS954E S3.8.1 |
| J5772 | Socket, 1" DR 2-1/4" 12 PT | ASME B107.1 | AS954E S3.8.1 |
| J5776 | Socket, 1" DR 2-3/8" 12 PT | ASME B107.1 | AS954E S3.8.1 |
| J5780 | Socket, 1" DR 2-1/2" 12 PT | ASME B107.1 | AS954E S3.8.1 |
| J5782 | Socket, 1" DR 2-9/16" 12 PT | ASME B107.1 | AS954E S3.8.1 |
| J5784 | Socket, 1" DR 2-5/8" 12 PT | ASME B107.1 | AS954E S3.8.1 |
| J5788 | Socket, 1" DR 2-3/4" 12 PT | ASME B107.1 | AS954E S3.8.1 |
| J5794 | Socket, 1" DR 2-15/16" 12 PT | ASME B107.1 | AS954E S3.8.1 |
| J5796 | Socket, 1" DR 3" 12 PT | ASME B107.1 | AS954E S3.8.1 |
| J5800 | Socket, 1" DR 3-1/8" 12 PT | ASME B107.1 | AS954E S3.8.1 |
| J5812 | Socket, 1" DR 3-1/2" 12 PT | ASME B107.1 | AS954E S3.8.1 |
| J5849 | Ratchet, 1" DR Classic Pear Head 26" | ASME B107.500 | |
| J5861 | Extension, 1" DR 8" | ASME B107.500 | AS 4283 |
| J5863 | Extension, 1" DR 17" | ASME B107.500 | AS 4283 |
| J5868 | Handle, Hinge 1" DR 27" | ASME B107.500 | AS 4283 |
| J5884 | Handle, Sliding T 1" DR 28-1/2" | ASME B107.500 | |
| J5885 | Sliding Drive Plug 1" DR | ASME B107.500 | |
| J5896 | Super Heavy-Duty Set Box | | |

1" DRIVE 17 PIECE SOCKET SET - 12 POINT

Product #: J57100

- › 12 Point Standard: 1-1/16, 1-1/8, 1-3/16, 1-1/4, 1-5/16, 1-3/8, 1-7/16, 1-1/2, 1-5/8, 1-11/16, 1-3/4, 1-13/16, 1-7/8, 2 Inch.
- › Accessories: Pear Head Ratchet, 8 Inch Extension, 27 Inch Hinge Handle, and Metal Box.
- › Weight (lbs): 65.50



| Contents | Description | ASME Spec. | AS Spec. |
|----------|--------------------------------------|---------------|---------------|
| J5734 | Socket, 1" DR 1-1/16" 12 PT | ASME B107.1 | AS954E S3.8.1 |
| J5736 | Socket, 1" DR 1-1/8" 12 PT | ASME B107.1 | AS954E S3.8.1 |
| J5738 | Socket, 1" DR 1-3/16" 12 PT | ASME B107.1 | AS954E S3.8.1 |
| J5740 | Socket, 1" DR 1-1/4" 12 PT | ASME B107.1 | AS954E S3.8.1 |
| J5742 | Socket, 1" DR 1-5/16" 12 PT | ASME B107.1 | AS954E S3.8.1 |
| J5744 | Socket, 1" DR 1-3/8" 12 PT | ASME B107.1 | AS954E S3.8.1 |
| J5746 | Socket, 1" DR 1-7/16" 12 PT | ASME B107.1 | AS954E S3.8.1 |
| J5748 | Socket, 1" DR 1-1/2" 12 PT | ASME B107.1 | AS954E S3.8.1 |
| J5752 | Socket, 1" DR 1-5/8" 12 PT | ASME B107.1 | AS954E S3.8.1 |
| J5754 | Socket, 1" DR 1-11/16" 12 PT | ASME B107.1 | AS954E S3.8.1 |
| J5756 | Socket, 1" DR 1-3/4" 12 PT | ASME B107.1 | AS954E S3.8.1 |
| J5758 | Socket, 1" DR 1-13/16" 12 PT | ASME B107.1 | AS954E S3.8.1 |
| J5760 | Socket, 1" DR 1-7/8" 12 PT | ASME B107.1 | AS954E S3.8.1 |
| J5764 | Socket, 1" DR 2" 12 PT | ASME B107.1 | AS954E S3.8.1 |
| J5849 | Ratchet, 1" DR Classic Pear Head 26" | ASME B107.500 | |
| J5861 | Extension, 1" DR 8" | ASME B107.500 | AS 4283 |
| J5868 | Handle, Hinge 1" DR 27" | ASME B107.500 | AS 4283 |
| J5894 | Super Heavy-Duty Set Box | | |



1" DRIVE STANDARD LENGTH CLASSIC PEAR HEAD RATCHET - MALE/FEMALE

- › An extra safety factor is provided through the use of a spring-loaded pellet in each male drive plug that snaps into a hole in the drive end of the socket and acts as a retaining pin. The socket stays locked on until the pellet is depressed and the socket is removed.
- › Robust 24-tooth gear design provides 15° ratcheting angle while maximizing ultimate torque.
- › Thin head design for access into tight work areas.
- › Reversing lever designed for quick, one-hand operation.



| Product # | Drive Size (in) | Finish | Overall Length (in) | Weight (lbs) | Repair Kit |
|--------------|-----------------|-------------|---------------------|--------------|---------------|
| J5849 | 1 | Full Polish | 26 | 13.02 | J5849RK |
| | | | | | ASME B107.500 |

1" DRIVE MALE PLUG

- › Replacement square drive for J5849.
- › J5849 male ratchet easily converts to a female ratchet by removing the male plug.



| Product # | Drive Size (in) | Finish | Overall Length (in) | Weight (lbs) | |
|--------------|-----------------|-------------|---------------------|--------------|---------------|
| J5852 | 1 | Black Oxide | 2-19/32 | 0.72 | |
| | | | | | ASME B107.500 |

1" DRIVE HINGE HANDLE

| Product # | Drive Size (in) | Finish | Overall Length (in) | Weight (lbs) | |
|--------------|-----------------|-------------|---------------------|--------------|---------------|
| J5868 | 1 | Full Polish | 27 | 7.56 | |
| | | | | | ASME B107.500 |



1" DRIVE BAR HANDLE AND SLIDING DRIVE PLUG

- › Made from alloy steel.
- › Heat-treated for strength and durability.

| Product # | Drive Size (in) | Finish | Overall Length (in) | Weight (lbs) | |
|--------------|-----------------|-------------|---------------------|--------------|---------------|
| J5884 | 1 | Full Polish | 28-1/2 | 6.30 | |
| J5885 | 1 | Full Polish | 3 | 1.20 | |
| | | | | | ASME B107.500 |



1" DRIVE STANDARD EXTENSIONS

| Product # | Drive Size (in) | Finish | Overall Length (in) | Weight (lbs) |
|--------------|-----------------|-------------|---------------------|--------------|
| J5861 | 1 | Full Polish | 8 | 2.88 |
| J5863 | 1 | Full Polish | 17 | 4.87 |

 ASME B107.500



1" DRIVE ADAPTERS

| Product # | Size (in) | Finish | Overall Length (in) | Weight (lbs) |
|--------------|---------------|-------------|---------------------|--------------|
| J5853 | 3/4" F x 1" M | Full Polish | 2-1/2 | 0.82 |
| J5854 | 1" F x 3/4" M | Full Polish | 2-7/8 | 1.27 |

 ASME B107.500



1" DRIVE SOCKETS - 12 POINT

► TorquePlus™ features apply.



| Product # | Size (in) (A) | Nut End Outside Dia. (in) (B) | Drive End Outside Dia. (in) (C) | Nut Depth (in) (D) | Bolt Clearance Depth (in) (E) | Overall Length (in) (L) | Weight (lbs) |
|--------------|---------------|-------------------------------|---------------------------------|--------------------|-------------------------------|-------------------------|--------------|
| J5734 | 1-1/16 | 1-41/64 | 1-29/32 | 3/4 | 1 | 2-7/16 | 0.96 |
| J5736 | 1-1/8 | 1-41/64 | 1-29/32 | 3/4 | 1 | 2-7/16 | 0.91 |
| J5738 | 1-3/16 | 1-45/64 | 1-29/32 | 7/8 | 1-1/8 | 2-7/16 | 0.91 |
| J5740 | 1-1/4 | 1-29/32 | 1-29/32 | 7/8 | 1-1/8 | 2-1/2 | 0.82 |
| J5742 | 1-5/16 | 2-1/32 | 2-1/32 | 7/8 | 1-5/32 | 2-21/32 | 1.39 |
| J5744 | 1-3/8 | 2-1/32 | 2-1/32 | 1 | 1-1/4 | 2-21/32 | 0.90 |
| J5746 | 1-7/16 | 2-1/4 | 2-1/32 | 1 | 1-19/64 | 2-3/4 | 0.92 |
| J5748 | 1-1/2 | 2-1/4 | 2-1/32 | 1 | 1-19/64 | 2-3/4 | 1.53 |
| J5752 | 1-5/8 | 2-3/8 | 2-5/32 | 1 | 1-7/8 | 3-1/4 | 1.18 |
| J5754 | 1-11/16 | 2-3/8 | 2-5/32 | 1 | 1-7/8 | 3-1/4 | 1.89 |
| J5756 | 1-3/4 | 2-3/8 | 2-5/32 | 1 | 1-25/32 | 3-1/4 | 2.07 |
| J5758 | 1-13/16 | 2-1/2 | 2-5/32 | 1-1/8 | 1-7/8 | 3-5/16 | 2.03 |
| J5760 | 1-7/8 | 2-11/16 | 2-13/32 | 1-1/4 | 1-61/64 | 3-5/16 | 2.10 |
| J5764 | 2 | 2-11/16 | 2-13/32 | 1-3/8 | 1-61/64 | 3-7/16 | 2.37 |
| J5766 | 2-1/16 | 2-11/16 | 2-13/32 | 1-3/8 | 1-61/64 | 3-1/2 | 2.69 |
| J5768 | 2-1/8 | 2-15/16 | 2-13/32 | 1-3/8 | 2-1/16 | 3-5/8 | 2.96 |
| J5770 | 2-3/16 | 3-5/64 | 2-13/32 | 1-3/8 | 2-5/32 | 3-3/4 | 3.03 |
| J5772 | 2-1/4 | 3-5/64 | 2-13/32 | 1-1/2 | 2-1/4 | 3-13/16 | 3.23 |
| J5774 | 2-5/16 | 3-1/4 | 2-13/32 | 1-14/16 | 2-1/8 | 3-17/64 | 3.08 |
| J5776 | 2-3/8 | 3-17/64 | 2-13/32 | 1-1/2 | 2-11/32 | 4 | 3.08 |
| J5778 | 2-7/16 | 3-17/64 | 2-13/32 | 1-11/16 | 2-11/32 | 3-13/32 | 3.20 |
| J5780 | 2-1/2 | 3-37/64 | 2-21/32 | 1-5/8 | 2-27/64 | 4-1/8 | 3.33 |
| J5782 | 2-9/16 | 3-37/64 | 2-21/32 | 1-5/8 | 2-27/64 | 4-1/8 | 3.22 |
| J5784 | 2-5/8 | 3-37/64 | 2-21/32 | 2-3/8 | 2-3/8 | 4-1/8 | 3.70 |
| J5788 | 2-3/4 | 1-13/16 | 2-21/32 | 1-3/4 | 2-21/32 | 4-7/16 | 4.82 |
| J5794 | 2-15/16 | 4-9/64 | 3-5/32 | 1-7/8 | 2-27/32 | 4-11/16 | 5.05 |
| J5796 | 3 | 4-9/64 | 3-5/32 | 1-53/64 | 3-1/32 | 4-11/16 | 5.61 |
| J5800 | 3-1/8 | 4-3/8 | 3-5/32 | 2 | 3-1/32 | 4-15/16 | 5.95 |
| J5812 | 3-1/2 | 4-11/16 | 3-5/32 | 2-1/4 | 3-1/8 | 5-1/8 | 9.11 |



AS954E S3.8.1

ASME B107.1



1" DRIVE METRIC SOCKETS - 12 POINT

METRIC

► TorquePlus™ features apply.



| Product # | Size | | Nut End | | Drive End | | Nut | | Bolt Clearance | | Overall Length | | Weight (lbs) |
|-----------|------|-----|-------------------|-----|-------------------|-----|------------|-----|----------------|-----|----------------|------|--------------|
| | (mm) | (A) | Outside Dia. (in) | (B) | Outside Dia. (in) | (C) | Depth (in) | (D) | Depth (in) | (E) | (in) | (L) | |
| J5735MT | 35 | | 1-15/16 | | 1-3/4 | | 1 | | 1-5/16 | | 2-7/16 | 0.93 | |
| J5736MT | 36 | | 2 | | 1-3/4 | | 1-1/16 | | 1-3/8 | | 2-1/2 | 0.98 | |
| J5738MT | 38 | | 2-1/8 | | 1-3/4 | | 1-1/16 | | 1-3/8 | | 2-9/16 | 1.05 | |
| J5741MT | 41 | | 2-1/4 | | 1-3/4 | | 1-1/4 | | 1-9/16 | | 2-11/16 | 1.20 | |
| J5746MT | 46 | | 2-9/16 | | 1-15/16 | | 1-3/8 | | 1-11/16 | | 2-14/16 | 1.81 | |
| J5750MT | 50 | | 2-3/4 | | 2-1/4 | | 1-9/16 | | 1-7/8 | | 3 | 2.38 | |
| J5754MT | 54 | | 2-15/16 | | 2-1/4 | | 1-9/16 | | 1-7/8 | | 2-1/16 | 2.63 | |
| J5755MT | 55 | | 3 | | 2-5/16 | | 1-13/16 | | 2-1/8 | | 3-1/4 | 2.79 | |
| J5758MT | 58 | | 3-3/16 | | 2-1/4 | | 1-13/16 | | 2-1/8 | | 3-1/4 | 3.12 | |
| J5760MT | 60 | | 3-1/4 | | 2-1/4 | | 1-7/8 | | 2-3/16 | | 3-5/16 | 3.22 | |
| J5763MT | 63 | | 3-3/8 | | 2-1/4 | | 2 | | 2-5/16 | | 3-7/16 | 3.28 | |
| J5765MT | 65 | | 3-3/8 | | 2-1/4 | | 2-1/16 | | 2-3/8 | | 3-1/2 | 3.27 | |
| J5770MT | 70 | | 3-3/4 | | 2-11/16 | | 2-1/4 | | 2-1/2 | | 3-13/16 | 4.81 | |
| J5771MT | 71 | | 3-13/16 | | 2-11/16 | | 2-1/4 | | 2-1/2 | | 3-13/16 | 4.99 | |
| J5774MT | 74 | | 3-15/16 | | 2-11/16 | | 2-1/4 | | 2-9/16 | | 3-7/8 | 5.28 | |
| J5775MT | 75 | | 3-15/16 | | 2-11/16 | | 2-1/4 | | 2-9/16 | | 3-7/8 | 5.10 | |
| J5777MT | 77 | | 4 | | 2-11/16 | | 2-1/4 | | 2-7/8 | | 4-3/16 | 5.10 | |
| J5780MT | 80 | | 4-3/16 | | 2-11/16 | | 2-1/4 | | 2-7/8 | | 4-3/16 | 5.82 | |

FEATURES AND BENEFITS —



- High performance drive configuration allows for quick and easy socket engagement to the fastener flats, not the corners.
- Employs a radius-corner design, shifting contact area and stress away from the fastener corners and distributing contact stresses over a large area of the socket, minimizing slippage.
- The internal design minimizes fastener rounding, helps to extend fastener life, and allows the user to more easily turn worn, rounded, or rusted fasteners.

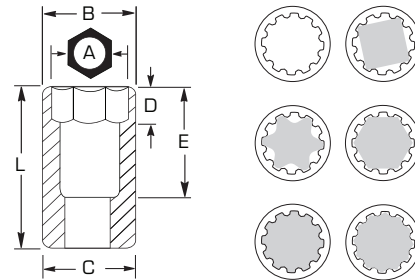

1" DRIVE SOCKETS - SPLINE

- Proto® Spline tools are designed to service high tensile strength fasteners used widely on military and commercial aircraft and in heavy machinery applications where vibration is prevalent. They are also used in automotive and industrial areas where high performance torque needs to be achieved.
- Spline sockets help tighten high-strength bolts to high torque loads. They help lower the force required to turn standard fasteners by allowing the torque load to be moved away from the corners to help prevent fastener rounding. They also turn fasteners with damaged corners.
- Spline sockets on spline fasteners help deliver twice the torque of 12 point wrenches on double-box fasteners, and more torque than hex wrenches on hex fasteners.
- Spline helps reduce foreign object debris (FOD) by having a precise fit between the fastening tool and its fastener.



| Product # | Size | | Nut End | | Drive End | | Nut | | Bolt Clearance | | Overall Length | | Weight (lbs) |
|-----------|--------|-----------------|-------------------|-----|-------------------|-----|------------|-----|----------------|-----|----------------|------|--------------|
| | (in) | (A) Spline Size | Outside Dia. (in) | (B) | Outside Dia. (in) | (C) | Depth (in) | (D) | Depth (in) | (E) | (in) | (L) | |
| J5732SPL | 1 | #32 | 1-1/2 | | 1-7/8 | | 7/8 | | 1-1/4 | | 2-7/16 | 0.82 | |
| J5734SPL | 1-1/16 | #34 | 1-1/2 | | 1-7/8 | | 7/8 | | 1-1/4 | | 2-1/2 | 0.91 | |
| J5736SPL | 1-1/8 | #36 | 1-5/8 | | 2 | | 1 | | 1-3/8 | | 2-1/2 | 1.00 | |
| J5738SPL | 1-3/16 | #38 | 1-11/16 | | 2 | | 1-3/16 | | 1-5/8 | | 2-3/4 | 1.09 | |
| J5740SPL | 1-1/4 | #40 | 1-11/15 | | 2 | | 1-3/16 | | 1-5/8 | | 2-3/4 | 1.18 | |
| J5742SPL | 1-5/16 | #42 | 1-7/8 | | 2 | | 1-3/16 | | 1-3/4 | | 2-7/8 | 1.27 | |
| J5744SPL | 1-3/8 | #44 | 2 | | 2 | | 1-3/16 | | 1-3/4 | | 3 | 1.37 | |
| J5746SPL | 1-7/16 | #46 | 2 | | 2 | | 1-1/4 | | 1-15/16 | | 3 | 1.46 | |
| J5748SPL | 1-1/2 | #48 | 2-1/8 | | 2-1/8 | | 1-5/16 | | 2 | | 3 | 1.55 | |



FACOM® INSULATED RATCHETS



- › Sockets and accessories secured by spring-ball.
- › 2 color warning handle insulation - color changes from orange to yellow if insulation integrity compromised.
- › For manual use.
- › Insulated to 1000V AC or 1500 DC.

| Product # | Drive Size (in) | Overall Length (in) (L) | Weight (lbs) |
|---------------------|-----------------|-------------------------|--------------|
| FT-R.151AVSE | 1/4 | 4-7/8 | 0.28 |
| FT-J.151AVSE | 3/8 | 7 | 0.53 |
| FT-S.151AVSE | 1/2 | 10-3/8 | 1.24 |



FACOM® INSULATED T-HANDLES



- › Sockets and accessories secured by spring-ball.
- › 2 color warning handle insulation - color changes from orange to yellow if insulation integrity compromised.
- › For manual use.
- › Insulated to 1000V AC or 1500 DC.

| Product # | Drive Size (in) | Overall Length (in) (L) | Weight (lbs) |
|---------------------|-----------------|-------------------------|--------------|
| FT-J.121AVSE | 3/8 | 8 | 0.85 |
| FT-S.121AVSE | 1/2 | 8-17/64 | 1.15 |



FACOM® INSULATED EXTENSIONS



| Product # | Drive Size (in) | Overall Length (in) (L) | Weight (lbs) |
|---------------------|-----------------|-------------------------|--------------|
| FT-R.210AVSE | 1/4 | 4-9/16 | 0.12 |
| FT-J.210AVSE | 3/8 | 5-29/32 | 0.33 |
| FT-J.215AVSE | 3/8 | 10-15/64 | 0.64 |
| FT-S.210AVSE | 1/2 | 5-45/64 | 0.55 |
| FT-S.215AVSE | 1/2 | 10-7/16 | 1.04 |





FACOM® 1/4" DRIVE 10 PIECE METRIC INSULATED SOCKET SET - 6 POINT

Product #: **FC-R.400AVSE**

- › 1000V AC and 1500DC Insulated Socket Set
- › Sockets: 6-12 mm
- › Hex Bit Sockets: 4-6 mm
- › Metric Size: Sockets: 6, 7, 8, 10, 12 mm
- › Accessories: Ratchet and 4-9/16 Inch Extension.
- › Weight (lbs): 1.47

| Contents | Description |
|--------------|--|
| FM-RT.4AVSE | Socket, Hex Bit 1/4 DR 1000V AC 4 mm 6 PT |
| FM-RT.5AVSE | Socket, Hex Bit 1/4" DR 1000V AC 5 mm 6 PT |
| FM-RT.6AVSE | Socket, Hex Bit 1/4" DR 1000V AC 6 mm 6 PT |
| FM-R.6AVSE | Socket, 1/4" DR 1000V AC 6 mm 6 PT |
| FM-R.7AVSE | Socket, 1/4" DR 1000V AC 7 mm 6 PT |
| FM-R.8AVSE | Socket, 1/4" DR 1000V AC 8 mm 6 PT |
| FM-R.10AVSE | Socket, 1/4" DR 1000V AC 10 mm 6 PT |
| FM-R.12AVSE | Socket, 1/4" DR 1000V AC 12 mm 6 PT |
| FT-R.151AVSE | Ratchet, 1/4" DR 1000V VSE 4-7/8" |
| FT-R.210AVSE | Extension, 1/4" DR 1000V VSE 4-9/16" |



FACOM® 1/4" DRIVE INSULATED RATCHET

- › Sockets and accessories secured by spring-ball.
- › 2 color warning handle insulation - color changes from orange to yellow if insulation integrity compromised.
- › For manual use.
- › Insulated to 1000V AC or 1500 DC.

| Product # | Overall Length (in) (L) | Weight (lbs) |
|---------------------|-------------------------|--------------|
| FT-R.151AVSE | 4-7/8 | 0.28 |



FACOM® 1/4" DRIVE INSULATED EXTENSION

| Product # | Size (in) | Overall Length (in) (L) | Weight (lbs) |
|---------------------|-----------|-------------------------|--------------|
| FT-R.210AVSE | 4-1/2 | 4-9/16 | 0.12 |



FACOM® 1/4" DRIVE INSULATED SOCKETS - 6 POINT



- › For manual use.
- › For working on live components up to 1000V AC and 1500 DC.



| Product # | Size (mm) | Nut End Outside Dia. (in) (B) | Drive End Outside Dia. (in) (C) | Overall Length (in) (L) | Weight (lbs) |
|-------------|-----------|----------------------------------|------------------------------------|-------------------------|--------------|
| FM-R.6AVSE | 6 | 5/8 | 55/64 | 55/64 | 0.04 |
| FM-R.7AVSE | 7 | 43/64 | 55/64 | 55/64 | 0.04 |
| FM-R.8AVSE | 8 | 43/64 | 55/64 | 55/64 | 0.04 |
| FM-R.10AVSE | 10 | 45/64 | 55/64 | 55/64 | 0.06 |
| FM-R.12AVSE | 12 | 55/64 | 55/64 | 55/64 | 0.07 |

FACOM® 1/4" DRIVE INSULATED HEX BIT SOCKETS



- › For manual use.
- › For working on live components up to 1000V AC and 1500 DC.

| Product # | Size (mm) | Overall Length (in) (L) | Weight (lbs) |
|-------------|-----------|----------------------------|--------------|
| FM-RT.4AVSE | 4 | 1-29/64 | 0.05 |
| FM-RT.5AVSE | 5 | 1-29/64 | 0.06 |
| FM-RT.6AVSE | 6 | 1-29/64 | 0.06 |



FACOM® 3/8" DRIVE 17 PIECE INSULATED SOCKET SET - 12 POINT

Product #: **FC-J.401AVSE**



- › 1000V AC and 1500DC Insulated Socket Set
- › Hex Bit Sockets: 4,5,6,7,8 mm
- › Metric Size Sockets: 8,10,11,12,13,14,15,17,19 mm
- › Accessories: Ratchet, T-Handle, and Extension. Weight (lbs): 4.96

| Contents | Description |
|--------------|--|
| FM-JT.4AVSE | Socket, Hex Bit 3/8" DR 1000V VSE 4 mm |
| FM-JT.5AVSE | Socket, Hex Bit 3/8" DR 1000V VSE 5 mm |
| FM-JT.6AVSE | Socket, Hex Bit 3/8" DR 1000V VSE 6 mm |
| FM-JT.7AVSE | Socket, Hex Bit 3/8" DR 1000V VSE 7 mm |
| FM-JT.8AVSE | Socket, Hex Bit 3/8" DR 1000V VSE 8 mm |
| FM-J.8AVSE | Socket, 3/8" DR 1000V VSE 8 mm |
| FM-J.10AVSE | Socket, 3/8" DR 1000V VSE 10 mm |
| FM-J.11AVSE | Socket, 3/8" DR 1000V VSE 11 mm |
| FM-J.12AVSE | Socket, 3/8" DR 1000V VSE 12 mm |
| FM-J.13AVSE | Socket, 3/8" DR 1000V VSE 13 mm |
| FM-J.14AVSE | Socket, 3/8" DR 1000V VSE 14 mm |
| FM-J.15AVSE | Socket, 3/8" DR 1000V VSE 15 mm |
| FM-J.17AVSE | Socket, 3/8" DR 1000V VSE 17 mm |
| FM-J.19AVSE | Socket, 3/8" DR 1000V VSE 19 mm |
| FT-J.121AVSE | T-Handle, 3/8" DR 1000V VSE |
| FT-J.151AVSE | Ratchet, 3/8" DR 1000V VSE 7" |
| FT-J.210AVSE | Extension, 3/8" DR 1000V VSE 5-29/32" |





FACOM® 3/8" DRIVE INSULATED RATCHET



- › Sockets and accessories secured by spring-ball.
- › 2 color warning handle insulation -color changes from orange to yellow if insulation integrity compromised.
- › For manual use.
- › Insulated to 1000V AC or 1500 DC.



| Product # | Size (in) | Overall Length (in) (L) | Weight (lbs) |
|---------------------|-----------|-------------------------|--------------|
| FT-J.151AVSE | 4-7/8 | 7 | 0.53 |

FACOM® 3/8" DRIVE INSULATED T-HANDLE



- › Sockets and accessories secured by spring-ball.
- › 2 color warning handle insulation - color changes from orange to yellow if insulation integrity compromised.
- › For manual use.
- › Insulated to 1000V AC or 1500 DC.



| Product # | Overall Length (in) (L) | Weight (lbs) |
|---------------------|-------------------------|--------------|
| FT-J.121AVSE | 8 | 0.85 |

FACOM® 3/8" DRIVE INSULATED EXTENSIONS



- › Sockets and accessories secured by spring-ball.
- › 2 color warning handle insulation - color changes from orange to yellow if insulation integrity compromised.
- › For manual use.
- › Insulated to 1000V AC or 1500 DC.



| Product # | Size (in) | Overall Length (in) (L) | Weight (lbs) |
|---------------------|-----------|-------------------------|--------------|
| FT-J.210AVSE | 5-7/8 | 5-29/32 | 0.33 |
| FT-J.215AVSE | 10-1/4 | 10-15/64 | 0.64 |



FACOM® 3/8" DRIVE METRIC INSULATED SOCKETS - 12 POINT

- › For manual use.
- › For working on live components up to 1000V AC and 1500DC.



| Product # | Size (mm) | Nut End Outside Dia. (in) (B) | Drive End Outside Dia. (in) (C) | Overall Length (in) (L) | Weight (lbs) |
|-------------|-----------|----------------------------------|------------------------------------|-------------------------|--------------|
| FM-J.8AVSE | 8 | 43/64 | 45/64 | 1-11/16 | 0.08 |
| FM-J.10AVSE | 10 | 25/32 | 45/64 | 1-11/16 | 0.08 |
| FM-J.11AVSE | 11 | 53/64 | 45/64 | 1-13/16 | 0.08 |
| FM-J.12AVSE | 12 | 55/64 | 45/64 | 1-13/16 | 0.09 |
| FM-J.13AVSE | 13 | 29/32 | 45/64 | 1-13/16 | 0.10 |
| FM-J.14AVSE | 14 | 63/64 | 45/64 | 1-13/16 | 0.10 |
| FM-J.15AVSE | 15 | 63/64 | 45/64 | 1-13/16 | 0.11 |
| FM-J.16AVSE | 16 | 1-1/16 | 45/64 | 1-13/16 | 0.13 |
| FM-J.17AVSE | 17 | 1-1/16 | 45/64 | 1-13/16 | 0.15 |
| FM-J.18AVSE | 18 | 1-9/64 | 45/64 | 1-13/16 | 0.16 |
| FM-J.19AVSE | 19 | 1-7/32 | 45/64 | 1-31/32 | 0.16 |

FACOM® 3/8" DRIVE METRIC DEEP INSULATED SOCKETS - 12 POINT



| Product # | Size (mm) | Nut End Outside Dia. (in) (B) | Drive End Outside Dia. (in) (C) | Overall Length (in) (L) | Weight (lbs) |
|--------------|-----------|----------------------------------|------------------------------------|----------------------------|--------------|
| FM-J.8LAVSE | 8 | 3/4 | 45/64 | 2-31/64 | 0.10 |
| FM-J.13LAVSE | 13 | 55/64 | 45/64 | 2-31/64 | 0.17 |
| FM-J.14LAVSE | 14 | 29/32 | 45/64 | 2-23/64 | 0.18 |
| FM-J.16LAVSE | 16 | 29/32 | 45/64 | 2-63/64 | 0.27 |
| FM-J.17LAVSE | 17 | 63/64 | 45/64 | 2-63/64 | 0.33 |
| FM-J.18LAVSE | 18 | 1-1/16 | 45/64 | 2-63/64 | 0.37 |
| FM-J.19LAVSE | 19 | 1-7/64 | 45/64 | 2-63/64 | 0.33 |

FACOM® 3/8" DRIVE INSULATED HEX BIT SOCKETS

- › For manual use.
- › For working on live components up to 1000V AC and 1500 DC.



| Product # | Size (mm) | Nut End Outside Dia. (in) (B) | Drive End Outside Dia. (in) (C) | Overall Length (in) (L) | Weight (lbs) |
|--------------|-----------|----------------------------------|------------------------------------|----------------------------|--------------|
| FM-JT.4AVSE | 4 | 25/64 | 45/64 | 3-5/32 | 0.10 |
| FM-JT.5AVSE | 5 | 25/64 | 45/64 | 2-9/16 | 0.10 |
| FM-JT.6AVSE | 6 | 25/64 | 45/64 | 2-9/16 | 0.10 |
| FM-JT.7AVSE | 7 | 25/64 | 45/64 | 2-9/16 | 0.11 |
| FM-JT.8AVSE | 8 | 25/64 | 45/64 | 2-3/4 | 0.13 |
| FM-JT.10AVSE | 10 | 25/64 | 45/64 | 2-3/4 | 0.13 |





FACOM® 1/2" DRIVE 17 PIECE INSULATED SOCKET SET - 12 POINT

Product #: FC-S.401AVSE



- › 1000V AC and 1500 DC Insulated Socket Set.
- › Hex Bit Sockets: 8, 10, 12, 14, 17 mm.
- › Metric Size Sockets - 12 Point: 8, 9, 10, 11, 12, 13, 14, 17, 19 mm.
- › Accessories: Ratchet, T-Handle, and Extension.
- › Weight (lbs): 7.56

| Contents | Description |
|--------------|---------------------------------------|
| FM-S.8AVSE | Socket, 1/2" DR 1000V VSE 8 mm 12 PT |
| FM-S.9AVSE | Socket, 1/2" DR 1000V VSE 9 mm 12 PT |
| FM-S.10AVSE | Socket, 1/2" DR 1000V VSE 10 mm 12 PT |
| FM-S.11AVSE | Socket, 1/2" DR 1000V VSE 11 mm 12 PT |
| FM-S.12AVSE | Socket, 1/2" DR 1000V VSE 12 mm 12 PT |
| FM-S.13AVSE | Socket, 1/2" DR 1000V VSE 13 mm 12 PT |
| FM-S.14AVSE | Socket, 1/2" DR 1000V VSE 14 mm 12 PT |
| FM-S.17AVSE | Socket, 1/2" DR 1000V VSE 17 mm 12 PT |
| FM-S.19AVSE | Socket, 1/2" DR 1000V VSE 19 mm 12 PT |
| FM-ST.8AVSE | Hex Bit, 1/2" DR 1000V VSE 8 mm |
| FM-ST.10AVSE | Hex Bit, 1/2" DR 1000V VSE 10 mm |
| FM-ST.12AVSE | Hex Bit, 1/2" DR 1000V VSE 12 mm |
| FM-ST.14AVSE | Hex Bit, 1/2" DR 1000V VSE 14 mm |
| FM-ST.17AVSE | Hex Bit, 1/2" DR 1000V VSE 17 mm |
| FT-S.121AVSE | T-Handle, 1/2" DR 1000V VSE |
| FT-S.151AVSE | Ratchet, 1/2" DR 1000V VSE 10-3/8" |
| FT-S.210AVSE | Extension, 1/2" DR 1000V VSE 5-45/64" |



FACOM® 1/2" DRIVE INSULATED RATCHET



- › Sockets and accessories secured by spring-ball.
- › 2 color warning handle insulation - color changes from orange to yellow if insulation integrity compromised.
- › For manual use.
- › Insulated to 1000V AC or 1500 DC.

| Product # | Overall Length (in) (L) | Weight (lbs) |
|---------------------|-------------------------|--------------|
| FT-S.151AVSE | 10-3/8 | 1.24 |



FACOM® 1/2" DRIVE INSULATED EXTENSIONS



| Product # | Size (in) | Overall Length (in) (L) | Weight (lbs) |
|---------------------|-----------|-------------------------|--------------|
| FT-S.210AVSE | 5-3/4 | 5-45/64 | 0.55 |
| FT-S.215AVSE | 10-3/8 | 10-7/16 | 1.04 |





FACOM® 1/2" DRIVE METRIC INSULATED SOCKETS - 12 POINT



| Product # | Size (mm) | Nut End | | Drive End | | Overall Length (in) (L) | Weight (lbs) |
|-------------|-----------|-----------------------|-----------------------|-----------------------|-----------------------|-------------------------|--------------|
| | | Outside Dia. (in) (B) | Outside Dia. (in) (C) | Outside Dia. (in) (B) | Outside Dia. (in) (C) | | |
| FM-S.8AVSE | 8 | 43/64 | 55/64 | 55/64 | 2-5/32 | 0.14 | |
| FM-S.9AVSE | 9 | 45/64 | 55/64 | 55/64 | 3-5/32 | 0.15 | |
| FM-S.10AVSE | 10 | 3/4 | 55/64 | 55/64 | 2-5/32 | 0.14 | |
| FM-S.11AVSE | 11 | 25/32 | 55/64 | 55/64 | 2-5/32 | 0.15 | |
| FM-S.12AVSE | 12 | 55/64 | 55/64 | 55/64 | 2-5/32 | 0.15 | |
| FM-S.13AVSE | 13 | 29/32 | 55/64 | 55/64 | 2-5/32 | 0.16 | |
| FM-S.14AVSE | 14 | 15/16 | 55/64 | 55/64 | 3-5/32 | 0.16 | |
| FM-S.17AVSE | 17 | 1-7/64 | 55/64 | 55/64 | 2-5/32 | 0.18 | |
| FM-S.19AVSE | 19 | 1-17/64 | 55/64 | 55/64 | 2-5/32 | 0.20 | |
| FM-S.21AVSE | 21 | 1-19/64 | 55/64 | 55/64 | 2-5/32 | 0.23 | |
| FM-S.22AVSE | 22 | 1-11/32 | 55/64 | 55/64 | 2-5/32 | 0.25 | |

FACOM® 1/2" DRIVE METRIC DEEP INSULATED SOCKETS - 12 POINT



| Product # | Size (mm) | Nut End | | Drive End | | Overall Length (in) (L) | Weight (lbs) |
|--------------|-----------|-----------------------|-----------------------|-----------------------|-----------------------|-------------------------|--------------|
| | | Outside Dia. (in) (B) | Outside Dia. (in) (C) | Outside Dia. (in) (B) | Outside Dia. (in) (C) | | |
| FM-S.12LAVSE | 12 | 55/64 | 55/64 | 55/64 | 3-1/32 | 0.39 | |
| FM-S.13LAVSE | 13 | 29/32 | 55/64 | 55/64 | 3-1/32 | 0.39 | |
| FM-S.14LAVSE | 14 | 15/16 | 55/64 | 55/64 | 3-1/32 | 0.39 | |
| FM-S.16LAVSE | 16 | 1-1/16 | 55/64 | 55/64 | 3-1/32 | 0.39 | |
| FM-S.17LAVSE | 17 | 1-3/32 | 55/64 | 55/64 | 3-1/32 | 0.39 | |
| FM-S.18LAVSE | 18 | 1-5/32 | 55/64 | 55/64 | 3-1/32 | 0.47 | |
| FM-S.19LAVSE | 19 | 1-1/4 | 55/64 | 55/64 | 3-1/32 | 0.52 | |

FACOM® 1/2" DRIVE INSULATED HEX BIT SOCKETS



| Product # | Size (mm) | Nut End | | Drive End | | Overall Length (in)(L) | Weight (lbs) |
|--------------|-----------|-----------------------|-----------------------|-----------------------|-----------------------|------------------------|--------------|
| | | Outside Dia. (in) (B) | Outside Dia. (in) (C) | Outside Dia. (in) (B) | Outside Dia. (in) (C) | | |
| FM-ST.8AVSE | 8 | 5/16 | 55/64 | 55/64 | 2-3/4 | 0.19 | |
| FM-ST.10AVSE | 10 | 25/64 | 55/64 | 55/64 | 2-3/4 | 0.19 | |
| FM-ST.12AVSE | 12 | 15/32 | 55/64 | 55/64 | 3-5/8 | 0.31 | |
| FM-ST.14AVSE | 14 | 35/64 | 55/64 | 55/64 | 3-5/8 | 0.34 | |
| FM-ST.17AVSE | 17 | 43/64 | 55/64 | 55/64 | 3-5/8 | 0.37 | |





PEAR HEAD RATCHET REPAIR KITS

| Product # | Drive Size (in) | Ratchet # | Weight (lbs) |
|--------------------|-----------------|------------|--------------|
| J4749XLRK | 1/4 | J4749XL | 0.04 |
| J4749XLHSRK | 1/4 | J4749XLHS | 0.06 |
| J4749RK | 1/4 | J4749 | 0.04 |
| J4749HSRK | 1/4 | J4749HS | 0.04 |
| J6064RK | 3/8 | J5248S | 0.07 |
| J5249XLRK | 3/8 | J5249XL | 0.13 |
| J5249FWRK | 3/8 | J5249FW | 0.13 |
| J5249HSRK | 3/8 | J5249HS | 0.15 |
| J5249XLHSRK | 3/8 | J5249XLHS | 0.15 |
| J5449RK | 1/2 | J5449 | 0.38 |
| J5449UTRK | 1/2 | J5449UT | 0.38 |
| J5449XLRK | 1/2 | J5449XL | 0.23 |
| J5449-14RK | 1/2 | J5449-14BL | 0.37 |
| J5450FWRK | 1/2 | J5450FW | 0.26 |
| J5649FWRK | 3/4 | J5649FW | 1.00 |
| J5649RK | 3/4 | J5649 | 1.00 |



REVERSE CAM REPAIR KITS

| Product # | Drive Size (in) | Weight (lbs) |
|----------------|-----------------|--------------|
| J5649RC | 3/4 | 0.02 |



ROUND HEAD RATCHET REPAIR KITS

| Product # | Drive Size (in) | Ratchet # | Weight (lbs) |
|-----------------|-----------------|----------------------------------|--------------|
| J4752FRK | 1/4 | J4752F, J4752FBL | 0.10 |
| J5252FRK | 3/8 | J5252F, J5252FBL, J5257F | 0.60 |
| J5452FRK | 1/2 | J5452F, J5452FBL, J5454F, J5457F | 0.30 |



**YOUR PRODUCTIVITY.
THAT'S WHAT WE'RE AIMING TO IMPACT.**

The point of an impact wrench is to get the job done right and fast. That means you can't be fussing with stripped fastener heads or cracked sockets. Proto® impact sockets are made from special alloy steel. They are heat treated for the correct balance of strength and hardness. One-piece construction ensures concentricity. We offer TorquePlus™ technology, a variety of drive styles and magnetic options to help eliminate slippage and rounding. Plus, our finish and wall thickness options ensure our sockets fit your environment and the task at hand. In short, they help give your efficiency a jolt.

IMPACT SOCKETS

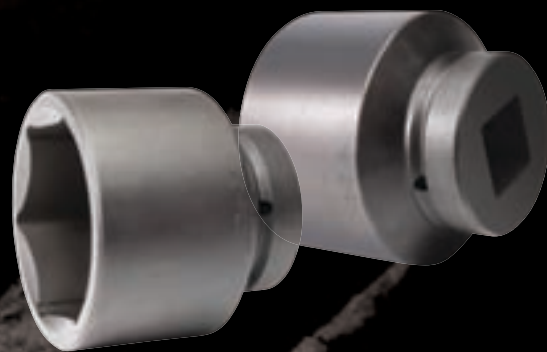

6 Point Impact Sockets for 1-1/2" Drive

PROTO

RETAINING SAFETY

Properly used, retaining rings hold sockets firmly in place on drive anvils.

- › Always use retaining rings with pneumatic drive anvils and sockets.
- › Install rings correctly to ensure all rotational force stays between the anvil and socket, as rings are only intended to support the weight of the socket.
- › Consider using crush gauge rings for added safety.
- › Be sure to inspect both drive anvil and socket carefully before using.

RETAINING RINGS

When used correctly, retaining rings improve both the safety and performance of pneumatic impact drivers. Proto® makes three styles.

Traditional Rings are made in two pieces that include a steel pin and O-ring. To install, slip the pin through the socket and drive anvil and slip the O-ring into the socket groove.



One-Piece Rings eliminate having to handle two small parts. They work in much the same way, but the pin is integrated into the ring and installs quickly.



Crush Gauge Rings work like one-piece rings, but they are specially designed to indicate damage or wear on sockets and drive anvils. Fast and reliable, they add an element of safety to your work.

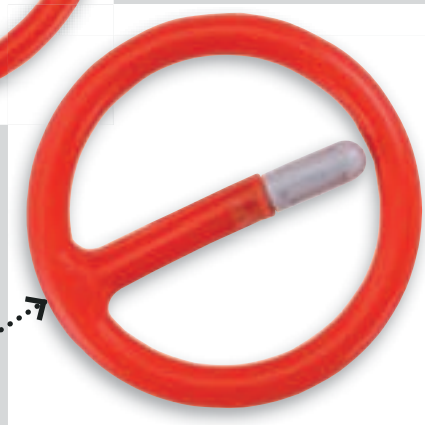



Straight Pin with Smooth Sides

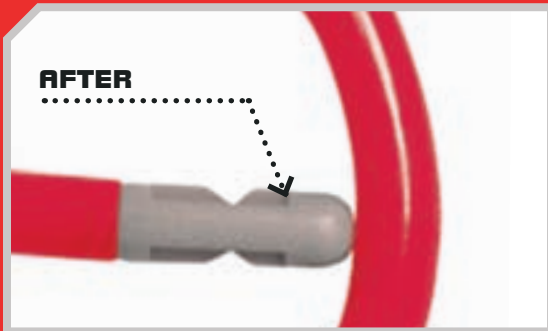

Bent Pin with Notched Sides

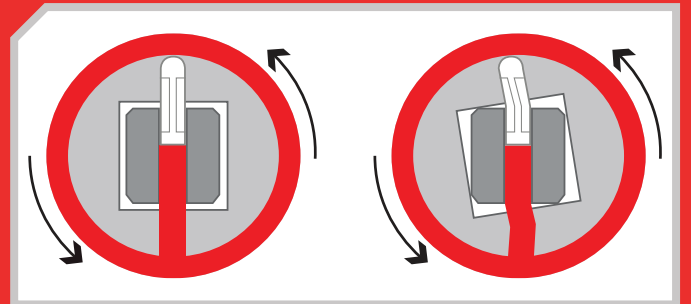

HOW THE CRUSH GAUGE IMPROVES SAFETY

Cracked or worn sockets pose a safety hazard. Our Crush Gauge Ring can indicate wear before there's a catastrophic failure. When a socket is cracked or excessively worn or when an anvil is worn, the drive tool and socket don't rotate tightly together. That action crimps the pin or "crush gauge" on the retaining ring. If that happens, you know to inspect and replace the socket or drive anvil.

1/4" DRIVE 13 PIECE METRIC IMPACT SOCKET SET - 6 POINT

METRIC

Product #: J69206



- › Proto® 6 Point Impact Sockets are ideal for use on stubborn or damaged fasteners, and also on fasteners made from soft materials.
- › TorquePlus™ features apply.
- › Weight (lbs): 0.88



| Contents | Description | ASME Spec. |
|----------|------------------------------------|---------------|
| J6904M | Socket, Impact 1/4" DR 4 mm 6 PT | ASME B107.33M |
| J6905M | Socket, Impact 1/4" DR 5 mm 6 PT | ASME B107.33M |
| J69055M | Socket, Impact 1/4" DR 5.5 mm 6 PT | ASME B107.33M |
| J6906M | Socket, Impact 1/4" DR 6 mm 6 PT | ASME B107.33M |
| J6907M | Socket, Impact 1/4" DR 7 mm 6 PT | ASME B107.33M |
| J6908M | Socket, Impact 1/4" DR 8 mm 6 PT | ASME B107.33M |
| J6909M | Socket, Impact 1/4" DR 9 mm 6 PT | ASME B107.33M |
| J6910M | Socket, Impact 1/4" DR 10 mm 6 PT | ASME B107.33M |
| J6911M | Socket, Impact 1/4" DR 11 mm 6 PT | ASME B107.33M |
| J6912M | Socket, Impact 1/4" DR 12 mm 6 PT | ASME B107.33M |
| J6913M | Socket, Impact 1/4" DR 13 mm 6 PT | ASME B107.33M |
| J6914M | Socket, Impact 1/4" DR 14 mm 6 PT | ASME B107.33M |
| J6915M | Socket, Impact 1/4" DR 15 mm 6 PT | ASME B107.33M |
| J2588 | Socket, Bar 11" | |
| J2590 | Socket, Clip 1/4" DR | |

1/4" DRIVE 11 PIECE IMPACT SOCKET SET - 6 POINT

Product #: J69106



- › Proto® 6 Point Impact Sockets are ideal for use on stubborn or damaged fasteners, and also on fasteners made from soft materials.
- › TorquePlus™ features apply.
- › Weight (lbs): 0.66



| Contents | Description | ASME Spec. |
|----------|------------------------------------|-------------|
| J6906H | Socket, Impact 1/4" DR 3/16" 6 PT | ASME B107.2 |
| J6907H | Socket, Impact 1/4" DR 7/32" 6 PT | ASME B107.2 |
| J6908H | Socket, Impact 1/4" DR 1/4" 6 PT | ASME B107.2 |
| J6909H | Socket, Impact 1/4" DR 9/32" 6 PT | ASME B107.2 |
| J6910H | Socket, Impact 1/4" DR 5/16" 6 PT | ASME B107.2 |
| J6911H | Socket, Impact 1/4" DR 11/32" 6 PT | ASME B107.2 |
| J6912H | Socket, Impact 1/4" DR 3/8" 6 PT | ASME B107.2 |
| J6914H | Socket, Impact 1/4" DR 7/16" 6 PT | ASME B107.2 |
| J6916H | Socket, Impact 1/4" DR 1/2" 6 PT | ASME B107.2 |
| J6918H | Socket, Impact 1/4" DR 9/16" 6 PT | ASME B107.2 |
| J6920H | Socket, Impact 1/4" DR 5/8" 6 PT | ASME B107.2 |
| J2585 | Socket, Bar 9" | |
| J2590 | Socket, Clip 1/4" DR | |



1/4" DRIVE 7 PIECE METRIC IMPACT SOCKET SET - 6 POINT

METRIC

Product #: J69202

- ▶ Proto® 6 Point Impact Sockets are ideal for use on stubborn or damaged fasteners, and also on fasteners made from soft materials.
- ▶ TorquePlus™ features apply.
- ▶ Weight (lbs): 0.40



| Contents | Description | ASME Spec. |
|----------|-----------------------------------|---------------|
| J6907M | Socket, Impact 1/4" DR 7 mm 6 PT | ASME B107.33M |
| J6908M | Socket, Impact 1/4" DR 8 mm 6 PT | ASME B107.33M |
| J6909M | Socket, Impact 1/4" DR 9 mm 6 PT | ASME B107.33M |
| J6910M | Socket, Impact 1/4" DR 10 mm 6 PT | ASME B107.33M |
| J6911M | Socket, Impact 1/4" DR 11 mm 6 PT | ASME B107.33M |
| J6912M | Socket, Impact 1/4" DR 12 mm 6 PT | ASME B107.33M |
| J6913M | Socket, Impact 1/4" DR 13 mm 6 PT | ASME B107.33M |
| J2584 | Socket, Bar 6-1/4" | |
| J2590 | Socket, Clip 1/4" DR | |



1/4" DRIVE 6 PIECE IMPACT SOCKET SET - 6 POINT

Product #: J69102

- ▶ Proto® 6 Point Impact Sockets are ideal for use on stubborn or damaged fasteners, and also on fasteners made from soft materials.
- ▶ TorquePlus™ features apply.
- ▶ Size stamped on tool for easy identification.
- ▶ Side locking hole.
- ▶ Weight (lbs): 0.40



| Contents | Description | ASME Spec. |
|----------|-----------------------------------|-------------|
| J6908H | Socket, Impact 1/4" DR 1/4" 6 PT | ASME B107.2 |
| J6910H | Socket, Impact 1/4" DR 5/16" 6 PT | ASME B107.2 |
| J6912H | Socket, Impact 1/4" DR 3/8" 6 PT | ASME B107.2 |
| J6914H | Socket, Impact 1/4" DR 7/16" 6 PT | ASME B107.2 |
| J6916H | Socket, Impact 1/4" DR 1/2" 6 PT | ASME B107.2 |
| J6918H | Socket, Impact 1/4" DR 9/16" 6 PT | ASME B107.2 |
| J2584 | Socket, Bar 6-1/4" | |
| J2590 | Socket, Clip 1/4" DR | |



FEATURES AND BENEFITS —

- ▶ High performance drive configuration allows for quick and easy socket engagement to the fastener flats, not the corners.
- ▶ Employs a radius-corner design, shifting contact area and stress away from the fastener corners and distributing contact stresses over a large area of the socket, minimizing slippage.
- ▶ The internal design minimizes fastener rounding, helps to extend fastener life, and allows the user to more easily turn worn, rounded, or rusted fasteners.





1/4" DRIVE 11 PIECE DEEP IMPACT SOCKET SET - 6 POINT

Product #: **J69116**



- › Proto® 6 Point Impact Sockets are ideal for use on stubborn or damaged fasteners, and also on fasteners made from soft materials.
- › TorquePlus™ features apply.
- › Size stamped on tool for easy identification.
- › Side locking hole.
- › Weight (lbs): 1.32



| Contents | Description | ASME Spec. |
|----------|---|-------------|
| J6506H | Socket, Impact 1/4" DR 3/16" 6 PT Deep | ASME B107.2 |
| J6507H | Socket, Impact 1/4" DR 7/32" 6 PT Deep | ASME B107.2 |
| J6508H | Socket, Impact 1/4" DR 1/4" 6 PT Deep | ASME B107.2 |
| J6509H | Socket, Impact 1/4" DR 9/32" 6 PT Deep | ASME B107.2 |
| J6510H | Socket, Impact 1/4" DR 5/16" 6 PT Deep | ASME B107.2 |
| J6511H | Socket, Impact 1/4" DR 11/32" 6 PT Deep | ASME B107.2 |
| J6512H | Socket, Impact 1/4" DR 3/8" 6 PT Deep | ASME B107.2 |
| J6514H | Socket, Impact 1/4" DR 7/16" 6 PT Deep | ASME B107.2 |
| J6516H | Socket, Impact 1/4" DR 1/2" 6 PT Deep | ASME B107.2 |
| J6518H | Socket, Impact 1/4" DR 9/16" 6 PT Deep | ASME B107.2 |
| J6520H | Socket, Impact 1/4" DR 5/8" 6 PT Deep | ASME B107.2 |
| J2585 | Socket, Bar 9" | |
| J2590 | Socket, Clip 1/4" DR | |

1/4" DRIVE 11 PIECE METRIC DEEP IMPACT SOCKET SET - 6 POINT

Product #: **J69212**



- › Proto® 6 Point Impact Sockets are ideal for use on stubborn or damaged fasteners, and also on fasteners made from soft materials.
- › TorquePlus™ features apply.
- › Weight (lbs): 1.36



| Contents | Description | ASME Spec. |
|----------|---|---------------|
| J6505MH | Socket, Impact 1/4" DR Metric - 5 mm 6 PT Deep | ASME B107.33M |
| J6506MH | Socket, Impact 1/4" DR Metric - 6 mm 6 PT Deep | ASME B107.33M |
| J6507MH | Socket, Impact 1/4" DR Metric - 7 mm 6 PT Deep | ASME B107.33M |
| J6508MH | Socket, Impact 1/4" DR Metric - 8 mm 6 PT Deep | ASME B107.33M |
| J6509MH | Socket, Impact 1/4" DR Metric - 9 mm 6 PT Deep | ASME B107.33M |
| J6510MH | Socket, Impact 1/4" DR Metric - 10 mm 6 PT Deep | ASME B107.33M |
| J6511MH | Socket, Impact 1/4" DR Metric - 11 mm 6 PT Deep | ASME B107.33M |
| J6512MH | Socket, Impact 1/4" DR Metric - 12 mm 6 PT Deep | ASME B107.33M |
| J6513MH | Socket, Impact 1/4" DR Metric - 13 mm 6 PT Deep | ASME B107.33M |
| J6514MH | Socket, Impact 1/4" DR Metric - 14 mm 6 PT Deep | ASME B107.33M |
| J6515MH | Socket, Impact 1/4" DR Metric - 15 mm 6 PT Deep | ASME B107.33M |
| J2585 | Socket, Bar 9" | |
| J2590 | Socket, Clip 1/4" DR | |



1/4" DRIVE 9 PIECE METRIC IMPACT UNIVERSAL SOCKET SET - 12 POINT

METRIC

Product #: J62133M



- › Weight (lbs): 2.20

| Contents | Description |
|----------|---|
| J66555MP | Socket, Impact 1/4" DR Universal 5.5 mm 12 PT |
| J66506MP | Socket, Impact 1/4" DR Universal 6 mm 12 PT |
| J66507MP | Socket, Impact 1/4" DR Universal 7 mm 12 PT |
| J66508MP | Socket, Impact 1/4" DR Universal 8 mm 12 PT |
| J66509MP | Socket, Impact 1/4" DR Universal 9 mm 12 PT |
| J66510MP | Socket, Impact 1/4" DR Universal 10 mm 12 PT |
| J66511MP | Socket, Impact 1/4" DR Universal 11 mm 12 PT |
| J66512MP | Socket, Impact 1/4" DR Universal 12 mm 12 PT |
| J66513MP | Socket, Impact 1/4" DR Universal 13 mm 12 PT |
| J2590 | Socket, Clip 1/4" DR |
| J2585 | Socket, Bar 9" |



1/4" DRIVE 7 PIECE TORX® IMPACT SOCKET SET

Product #: J69132



- › Proto® 6 Point Impact Sockets are ideal for use on stubborn or damaged fasteners, and also on fasteners made from soft materials.
- › TorquePlus™ features apply.
- › Weight (lbs): 0.38



| Contents | Description | Torx® Size |
|----------|----------------------------------|------------|
| J6904TX | Socket, Impact Torx® 1/4" DR E4 | E4 |
| J6905TX | Socket, Impact Torx® 1/4" DR E5 | E5 |
| J6906TX | Socket, Impact Torx® 1/4" DR E6 | E6 |
| J6907TX | Socket, Impact Torx® 1/4" DR E7 | E7 |
| J6908TX | Socket, Impact Torx® 1/4" DR E8 | E8 |
| J6910TX | Socket, Impact Torx® 1/4" DR E10 | E10 |
| J6912TX | Socket, Impact Torx® 1/4" DR E12 | E12 |
| J2584 | Socket, Bar 6-1/4" | |
| J2590 | Socket, Clip 1/4" DR | |



1/4" DRIVE IMPACT SOCKETS - 6 POINT

- › Proto® 6 Point Impact Sockets are ideal for use on stubborn or damaged fasteners, and also on fasteners made from soft materials.
- › TorquePlus™ features apply.
- › Socket size stamped on tool for easy identification.
- › Side locking hole.



| Product # | Size (in) (A) | Nut End Outside Dia. (in) (B) | Drive End Outside Dia. (in) (C) | Nut Depth (in) (D) | Bolt Clearance Depth (in) (E) | Overall Length (in) (L) | Weight (lbs) |
|-----------|---------------|-------------------------------|---------------------------------|--------------------|-------------------------------|-------------------------|--------------|
| J6906H | 3/16 | 5/16 | 1/2 | 11/64 | 1/2 | 7/8 | 0.04 |
| J6907H | 7/32 | 11/32 | 1/2 | 13/64 | 1/2 | 7/8 | 0.03 |
| J6908H | 1/4 | 25/64 | 1/2 | 7/32 | 1/2 | 7/8 | 0.03 |
| J6909H | 9/32 | 7/16 | 1/2 | 15/64 | 1/2 | 7/8 | 0.03 |
| J6910H | 5/16 | 1/2 | 1/2 | 15/64 | 1/2 | 7/8 | 0.03 |
| J6911H | 11/32 | 33/64 | 33/64 | 17/64 | 1/2 | 7/8 | 0.04 |
| J6912H | 3/8 | 9/16 | 9/16 | 17/64 | 1/2 | 7/8 | 0.04 |
| J6914H | 7/16 | 21/32 | 21/32 | 5/16 | 1/2 | 7/8 | 0.05 |
| J6916H | 1/2 | 45/64 | 11/16 | 3/8 | 1/2 | 7/8 | 0.05 |
| J6918H | 9/16 | 51/64 | 51/64 | 3/8 | 1/2 | 7/8 | 0.08 |
| J6920H | 5/8 | 7/8 | 7/8 | 3/8 | 1/2 | 7/8 | 0.09 |



ASME B107.2

FEATURES AND BENEFITS —



- › High performance drive configuration allows for quick and easy socket engagement to the fastener flats, not the corners.
- › Employs a radius-corner design, shifting contact area and stress away from the fastener corners and distributing contact stresses over a large area of the socket, minimizing slippage.
- › The internal design minimizes fastener rounding, helps to extend fastener life, and allows the user to more easily turn worn, rounded, or rusted fasteners.

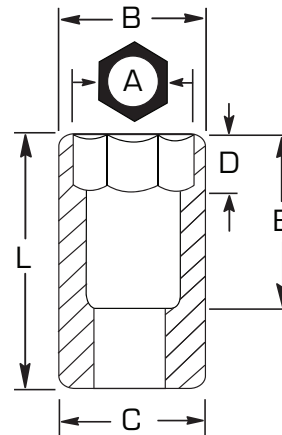

1/4" DRIVE METRIC IMPACT SOCKETS - 6 POINT

METRIC

- › Proto® 6 Point Impact Sockets are ideal for use on stubborn or damaged fasteners, and also on fasteners made from soft materials.
- › TorquePlus™ features apply.
- › Socket size stamped on tool for easy identification.
- › Side locking hole.



| Product # | Size (mm) (A) | Nut End Outside Dia. (in) (B) | Drive End Outside Dia. (in) (C) | Nut Depth (in) (D) | Bolt Clearance Depth (in) (E) | Overall Length (in) (L) | Weight (lbs) |
|-----------|---------------|-------------------------------|---------------------------------|--------------------|-------------------------------|-------------------------|--------------|
| J6904M | 4 | 17/64 | 1/2 | 5/32 | 1/2 | 7/8 | 0.03 |
| J6905M | 5 | 5/16 | 1/2 | 3/16 | 1/2 | 7/8 | 0.04 |
| J69055M | 5.5 | 11/32 | 1/2 | 3/16 | 1/2 | 7/8 | 0.04 |
| J6906M | 6 | 25/64 | 1/2 | 7/32 | 1/2 | 7/8 | 0.03 |
| J6907M | 7 | 7/16 | 1/2 | 7/32 | 1/2 | 7/8 | 0.03 |
| J6908M | 8 | 1/2 | 1/2 | 7/32 | 1/2 | 7/8 | 0.04 |
| J6909M | 9 | 33/64 | 33/64 | 1/4 | 1/2 | 7/8 | 0.04 |
| J6910M | 10 | 9/16 | 9/16 | 1/4 | 1/2 | 7/8 | 0.04 |
| J6911M | 11 | 21/32 | 21/32 | 9/32 | 1/2 | 7/8 | 0.05 |
| J6912M | 12 | 11/16 | 11/16 | 19/64 | 1/2 | 7/8 | 0.06 |
| J6913M | 13 | 23/32 | 23/32 | 5/16 | 1/2 | 7/8 | 0.07 |
| J6914M | 14 | 51/64 | 51/64 | 3/8 | 1/2 | 7/8 | 0.08 |
| J6915M | 15 | 53/64 | 53/64 | 3/8 | 1/2 | 7/8 | 0.08 |



ASME B107.33M

1/4" DRIVE DEEP IMPACT SOCKETS - 6 POINT

- › Proto® 6 Point Impact Sockets are ideal for use on stubborn or damaged fasteners, and also on fasteners made from soft materials.
- › TorquePlus™ features apply.
- › Socket size stamped on tool for easy identification.
- › Side locking hole.



| Product # | Size (in) (A) | Nut End Outside Dia. (in) (B) | Drive End Outside Dia. (in) (C) | Nut Depth (in) (D) | Bolt Clearance Depth (in) (E) | Overall Length (in) (L) | Weight (lbs) |
|-----------|---------------|-------------------------------|---------------------------------|--------------------|-------------------------------|-------------------------|--------------|
| J6506H | 3/16 | 5/16 | 1/2 | 1/4 | 1-5/8 | 2 | 0.08 |
| J6507H | 7/32 | 23/64 | 1/2 | 7/64 | 1-5/8 | 2 | 0.08 |
| J6508H | 1/4 | 25/64 | 1/2 | 9/32 | 1-5/8 | 2 | 0.08 |
| J6509H | 9/32 | 7/16 | 1/2 | 19/64 | 1-5/8 | 2 | 0.08 |
| J6510H | 5/16 | 1/2 | 1/2 | 5/16 | 1-5/8 | 2 | 0.07 |
| J6511H | 11/32 | 33/64 | 33/64 | 11/32 | 1-5/8 | 2 | 0.07 |
| J6512H | 3/8 | 9/16 | 9/16 | 3/8 | 1-5/8 | 2 | 0.09 |
| J6514H | 7/16 | 21/32 | 21/32 | 3/8 | 1-5/8 | 2 | 0.12 |
| J6516H | 1/2 | 11/16 | 11/16 | 7/16 | 1-5/8 | 2 | 0.12 |
| J6518H | 9/16 | 51/64 | 51/64 | 7/16 | 1-5/8 | 2 | 0.15 |
| J6520H | 5/8 | 7/8 | 7/8 | 7/16 | 1-5/8 | 2 | 0.12 |



ASME B107.2



1/4" DRIVE METRIC DEEP IMPACT SOCKETS - 6 POINT



- › Proto® 6 Point Impact Sockets are ideal for use on stubborn or damaged fasteners, and also on fasteners made from soft materials.
- › TorquePlus™ features apply.
- › Socket size stamped on tool for easy identification.
- › Side locking hole.



| Product # | Size (mm) | Nut End | | Drive End | | Nut | | Bolt Clearance | | Overall Length | | Weight (lbs) |
|-----------|-----------|-----------------------|-----------------------|-----------------------|----------------|----------------|----------------|----------------|----------|----------------|--|--------------|
| | (A) | Outside Dia. (in) (B) | Outside Dia. (in) (C) | Outside Dia. (in) (C) | Depth (in) (D) | Depth (in) (D) | Depth (in) (E) | Depth (in) (E) | (in) (L) | (in) (L) | | |
| J6505MH | 5 | 5/16 | 1/2 | 1/2 | 1/4 | 1-5/8 | 2 | 0.08 | | | | |
| J65055MH | 5.5 | 23/64 | 1/2 | 1/2 | 17/64 | 1-5/8 | 2 | 0.09 | | | | |
| J6506MH | 6 | 25/64 | 1/2 | 1/2 | 9/32 | 1-5/8 | 2 | 0.08 | | | | |
| J6507MH | 7 | 7/16 | 1/2 | 1/2 | 19/64 | 1-5/8 | 2 | 0.08 | | | | |
| J6508MH | 8 | 1/2 | 1/2 | 1/2 | 5/16 | 1-5/8 | 2 | 0.07 | | | | |
| J6509MH | 9 | 33/64 | 33/64 | 33/64 | 5/16 | 1-5/8 | 2 | 0.07 | | | | |
| J6510MH | 10 | 9/16 | 9/16 | 9/16 | 3/8 | 1-5/8 | 2 | 0.08 | | | | |
| J6511MH | 11 | 21/32 | 21/32 | 21/32 | 3/8 | 1-5/8 | 2 | 0.11 | | | | |
| J6512MH | 12 | 11/16 | 11/16 | 11/16 | 13/32 | 1-5/8 | 2 | 0.13 | | | | |
| J6513MH | 13 | 23/32 | 23/32 | 23/32 | 7/16 | 1-5/8 | 2 | 0.14 | | | | |
| J6514MH | 14 | 51/64 | 51/64 | 51/64 | 7/16 | 1-5/8 | 2 | 0.18 | | | | |
| J6515MH | 15 | 53/64 | 53/64 | 53/64 | 7/16 | 1-5/8 | 2 | 0.18 | | | | |



ASME B107.33M

1/4" DRIVE HIGH STRENGTH MAGNETIC SOCKETS - 6 POINT

- › ProtoGrip™ Magnetic Sockets use high-strength magnets made from a rare earth magnet alloy/nylon blend.
- › ProtoGrip™ Magnetic Sockets require no bushings to hold the magnet in place. Allows room for more magnet material, helping increase total magnetic strength.
- › Designed to easily pick up heavy fasteners and hold them tightly during use.
- › Strong magnetic hold helps increase efficiency when installing fasteners in awkward or hard-to-reach locations.
- › Impact sockets with high impact strength are used in automated and hand impact socket applications.
- › Size stamped on tool for easy identification.



| Product # | Size (in) | Nut End | | Drive End | | Nut | | Overall Length | | Weight (lbs) |
|-----------|-----------|-----------------------|-----------------------|-----------------------|----------------|----------------|----------------|----------------|----------|--------------|
| | (A) | Outside Dia. (in) (B) | Outside Dia. (in) (C) | Outside Dia. (in) (C) | Depth (in) (D) | Depth (in) (D) | Depth (in) (D) | (in) (L) | (in) (L) | |
| J6906HF | 3/16 | 5/16 | 1/2 | 1/2 | 5/32 | 7/8 | 0.03 | | | |
| J6908HF | 1/4 | 25/64 | 1/2 | 1/2 | 11/64 | 7/8 | 0.04 | | | |
| J6910HF | 5/16 | 1/2 | 1/2 | 1/2 | 13/64 | 59/64 | 0.04 | | | |
| J6912HF | 3/8 | 9/16 | 9/16 | 9/16 | 15/64 | 15/16 | 0.05 | | | |
| J6914HF | 7/16 | 21/32 | 21/32 | 21/32 | 1/4 | 1 | 0.07 | | | |
| J6916HF | 1/2 | 11/16 | 11/16 | 11/16 | 1/4 | 1 | 0.07 | | | |



ASME B107.2



1/4" DRIVE METRIC HIGH STRENGTH MAGNETIC IMPACT SOCKETS - 6 POINT

METRIC

- ▶ ProtoGrip™ Magnetic Sockets use high-strength magnets made from a rare earth magnet alloy/nylon blend.
- ▶ ProtoGrip™ Magnetic Sockets require no bushings to hold the magnet in place. Allows room for more magnet material, helping increase total magnetic strength.
- ▶ Designed to easily pick up heavy fasteners and hold them tightly during use.
- ▶ Strong magnetic hold helps increase efficiency when installing fasteners in awkward or hard-to-reach locations.
- ▶ Impact sockets with high impact strength are used in automated and hand impact socket applications.
- ▶ Size stamped on tool for easy identification.



| Product # | Size (mm) (A) | Nut End Outside Dia. (in) (B) | Drive End Outside Dia. (in) (C) | Nut Depth (in) (D) | Overall Length (in) (L) | Weight (lbs) |
|------------------|---------------|-------------------------------|---------------------------------|--------------------|-------------------------|--------------|
| J6905MHF | 5 | 5/16 | 1/2 | 1/16 | 7/8 | 0.03 |
| J69055MHF | 5.5 | 23/64 | 1/2 | 3/32 | 7/8 | 0.03 |
| J6906MHF | 6 | 25/64 | 1/2 | 7/64 | 7/8 | 0.06 |
| J6907MHF | 7 | 25/64 | 1/2 | 7/64 | 15/16 | 0.04 |
| J6908MHF | 8 | 1/2 | 1/2 | 1/8 | 15/16 | 0.04 |
| J6910MHF | 10 | 9/16 | 9/16 | 5/32 | 15/16 | 0.05 |



ASME B107.33



1/4" DRIVE UNIVERSAL IMPACT SOCKETS - 12 POINT

| Product # | Size (in) | Drive End Outside Dia. (in) (C) | Overall Length (in) (L) | Weight (lbs) |
|----------------|-----------|---------------------------------|-------------------------|--------------|
| J66308P | 1/4 | 5/8 | 1-9/32 | 0.27 |
| J66310P | 5/16 | 5/8 | 1-11/32 | 0.27 |
| J66312P | 3/8 | 5/8 | 1-15/32 | 0.30 |
| J66314P | 7/16 | 5/8 | 1-1/2 | 0.32 |
| J66316P | 1/2 | 5/8 | 1-5/8 | 0.33 |



1/4" DRIVE METRIC UNIVERSAL IMPACT SOCKETS - 12 POINT

| Product # | Size (mm) | Drive End | | Overall | |
|-----------|-----------|-------------------|-----|-------------|------|
| | | Outside Dia. (in) | (C) | Length (in) | (L) |
| J66506MP | 6 | 5/8 | | 1-9/32 | 0.27 |
| J66507MP | 7 | 5/8 | | 1-5/16 | 0.27 |
| J66508MP | 8 | 5/8 | | 1-11/32 | 0.28 |
| J66509MP | 9 | 5/8 | | 1-3/8 | 0.30 |
| J66510MP | 10 | 5/8 | | 1-7/16 | 0.31 |
| J66511MP | 11 | 5/8 | | 1-1/2 | 0.31 |
| J66512MP | 12 | 5/8 | | 1-17/32 | 0.32 |
| J66513MP | 13 | 5/8 | | 1-19/32 | 0.32 |
| J66555MP | 5.5 | 5/8 | | 1-1/4 | 0.27 |



1/4" DRIVE IMPACT UNIVERSAL JOINT

- › Tight tolerances for snug fit on fastener.
- › Used wherever powered drive tools are used to install or remove fasteners.
- › Designed to withstand the high torque and force associated with impact tools in repetitive application.
- › Features two through holes and a groove to accept a Proto® Retaining Ring or pin and O-ring to help secure the socket to the drive tool anvil.
- › Position at appropriate angle to turn fasteners where obstructions prevent a straight application.
- › Ball and spring design which allows for a 30° working angle.
- › Smooth 360° rotation.

| Product # | Drive End Outside Dia. (in) (C) | Overall Length (in) (L) | Weight (lbs) |
|-----------|---------------------------------|-------------------------|--------------|
| J66170P | 5/8 | 1-3/8 | 0.27 |



1/4" DRIVE TORX® IMPACT SOCKETS

- › Made of alloy steel.
- › Black oxide finish.
- › For use with Torx® style fasteners.



| Product # | Torx® Size | Nut End Outside Dia. (B) | Drive End Outside Dia. (C) | Nut Depth (D) | Overall Length (in) | Weight (lbs) |
|-----------|------------|--------------------------|----------------------------|---------------|---------------------|--------------|
| J6904TX | E4 | 1/4 | 7/16 | 13/64 | 1 | 0.03 |
| J6905TX | E5 | 1/4 | 7/16 | 7/32 | 1 | 0.04 |
| J6906TX | E6 | 5/16 | 7/16 | 15/64 | 1 | 0.02 |
| J6907TX | E7 | 21/64 | 1/2 | 9/32 | 1 | 0.03 |
| J6908TX | E8 | 3/8 | 19/64 | 19/64 | 1 | 0.03 |
| J6910TX | E10 | 1/2 | 1/2 | 11/32 | 1 | 0.05 |
| J6912TX | E12 | 9/16 | 9/16 | 25/64 | 1 | 0.05 |



3/8" DRIVE 19 PIECE METRIC IMPACT SOCKET SET - 6 POINT

METRIC

Product #: J72206



| Contents | Description | ASME Spec. |
|----------|-----------------------------------|---------------|
| J7206M | Socket, Impact 3/8" DR 6 mm 6 PT | ASME B107.33M |
| J7207M | Socket, Impact 3/8" DR 7 mm 6 PT | ASME B107.33M |
| J7208M | Socket, Impact 3/8" DR 8 mm 6 PT | ASME B107.33M |
| J7209M | Socket, Impact 3/8" DR 9 mm 6 PT | ASME B107.33M |
| J7210M | Socket, Impact 3/8" DR 10 mm 6 PT | ASME B107.33M |
| J7211M | Socket, Impact 3/8" DR 11 mm 6 PT | ASME B107.33M |
| J7212M | Socket, Impact 3/8" DR 12 mm 6 PT | ASME B107.33M |
| J7213M | Socket, Impact 3/8" DR 13 mm 6 PT | ASME B107.33M |
| J7214M | Socket, Impact 3/8" DR 14 mm 6 PT | ASME B107.33M |
| J7215M | Socket, Impact 3/8" DR 15 mm 6 PT | ASME B107.33M |
| J7216M | Socket, Impact 3/8" DR 16 mm 6 PT | ASME B107.33M |
| J7217M | Socket, Impact 3/8" DR 17 mm 6 PT | ASME B107.33M |
| J7218M | Socket, Impact 3/8" DR 18 mm 6 PT | ASME B107.33M |
| J7219M | Socket, Impact 3/8" DR 19 mm 6 PT | ASME B107.33M |
| J7220M | Socket, Impact 3/8" DR 20 mm 6 PT | ASME B107.33M |
| J7221M | Socket, Impact 3/8" DR 21 mm 6 PT | ASME B107.33M |
| J7222M | Socket, Impact 3/8" DR 22 mm 6 PT | ASME B107.33M |
| J7223M | Socket, Impact 3/8" DR 23 mm 6 PT | ASME B107.33M |
| J7224M | Socket, Impact 3/8" DR 24 mm 6 PT | ASME B107.33M |
| J2587 | Socket, Bar 17" | |
| J2591 | Socket, Clip 3/8" DR | |

- ▶ Proto® 6 Point Impact Sockets are ideal for use on stubborn or damaged fasteners, and also on fasteners made from soft materials.
- ▶ TorquePlus™ features apply.
- ▶ Weight (lbs): 2.79



3/8" DRIVE 19 PIECE METRIC DEEP IMPACT SOCKET SET - 6 POINT

Product #: J72216



- ▶ Proto® 6 Point Impact Sockets are ideal for use on stubborn or damaged fasteners, and also on fasteners made from soft materials.
- ▶ TorquePlus™ features apply.
- ▶ Weight (lbs): 6.43



| Contents | Description | ASME Spec. |
|----------|--|---------------|
| J7006M | Socket, Impact 3/8" DR 6 mm 6 PT Deep | ASME B107.33M |
| J7007M | Socket, Impact 3/8" DR 7 mm 6 PT Deep | ASME B107.33M |
| J7008M | Socket, Impact 3/8" DR 8 mm 6 PT Deep | ASME B107.33M |
| J7009M | Socket, Impact 3/8" DR 9 mm 6 PT Deep | ASME B107.33M |
| J7010M | Socket, Impact 3/8" DR 10 mm 6 PT Deep | ASME B107.33M |
| J7011M | Socket, Impact 3/8" DR 11 mm 6 PT Deep | ASME B107.33M |
| J7012M | Socket, Impact 3/8" DR 12 mm 6 PT Deep | ASME B107.33M |
| J7013M | Socket, Impact 3/8" DR 13 mm 6 PT Deep | ASME B107.33M |
| J7014M | Socket, Impact 3/8" DR 14 mm 6 PT Deep | ASME B107.33M |
| J7015M | Socket, Impact 3/8" DR 15 mm 6 PT Deep | ASME B107.33M |
| J7016M | Socket, Impact 3/8" DR 16 mm 6 PT Deep | ASME B107.33M |
| J7017M | Socket, Impact 3/8" DR 17 mm 6 PT Deep | ASME B107.33M |
| J7018M | Socket, Impact 3/8" DR 18 mm 6 PT Deep | ASME B107.33M |
| J7019M | Socket, Impact 3/8" DR 19 mm 6 PT Deep | ASME B107.33M |
| J7020M | Socket, Impact 3/8" DR 20 mm 6 PT Deep | ASME B107.33M |
| J7021M | Socket, Impact 3/8" DR 21 mm 6 PT Deep | ASME B107.33M |
| J7022M | Socket, Impact 3/8" DR 22 mm 6 PT Deep | ASME B107.33M |
| J7023M | Socket, Impact 3/8" DR 23 mm 6 PT Deep | ASME B107.33M |
| J7024M | Socket, Impact 3/8" DR 24 mm 6 PT Deep | ASME B107.33M |
| J2587 | Socket, Bar 17" | |
| J2591 | Socket, Clip 3/8" DR | |



3/8" DRIVE 15 PIECE DEEP IMPACT SOCKET SET - 6 POINT

Product #: **J72116**



- › Proto® 6 Point Impact Sockets are ideal for use on stubborn or damaged fasteners, and also on fasteners made from soft materials.
- › TorquePlus™ features apply.
- › Weight (lbs): 5.81



| Contents | Description | ASME Spec. |
|----------|---|-------------|
| J7708H | Socket, Impact 3/8" DR 1/4" 6 PT Deep | ASME B107.2 |
| J7709H | Socket, Impact 3/8" DR 9/32" 6 PT Deep | ASME B107.2 |
| J7710H | Socket, Impact 3/8" DR 5/16" 6 PT Deep | ASME B107.2 |
| J7711H | Socket, Impact 3/8" DR 11/32" 6 PT Deep | ASME B107.2 |
| J7712H | Socket, Impact 3/8" DR 3/8" 6 PT Deep | ASME B107.2 |
| J7714H | Socket, Impact 3/8" DR 7/16" 6 PT Deep | ASME B107.2 |
| J7716H | Socket, Impact 3/8" DR 1/2" 6 PT Deep | ASME B107.2 |
| J7718H | Socket, Impact 3/8" DR 9/16" 6 PT Deep | ASME B107.2 |
| J7720H | Socket, Impact 3/8" DR 5/8" 6 PT Deep | ASME B107.2 |
| J7722H | Socket, Impact 3/8" DR 11/16" 6 PT Deep | ASME B107.2 |
| J7724H | Socket, Impact 3/8" DR 3/4" 6 PT Deep | ASME B107.2 |
| J7726H | Socket, Impact 3/8" DR 13/16" 6 PT Deep | ASME B107.2 |
| J7728H | Socket, Impact 3/8" DR 7/8" 6 PT Deep | ASME B107.2 |
| J7730H | Socket, Impact 3/8" DR 15/16" 6 PT Deep | ASME B107.2 |
| J7732H | Socket, Impact 3/8" DR 1" 6 PT Deep | ASME B107.2 |
| J2587 | Socket, Bar 17" | |
| J2591 | Socket, Clip 3/8" DR | |

3/8" DRIVE 15 PIECE IMPACT SOCKET SET - 6 POINT

Product #: **J72106**



- › Proto® 6 Point Impact Sockets are ideal for use on stubborn or damaged fasteners, and also on fasteners made from soft materials.
- › TorquePlus™ features apply.
- › Weight (lbs): 2.89



| Contents | Description | ASME Spec. |
|----------|------------------------------------|-------------|
| J7208H | Socket, Impact 3/8" DR 1/4" 6 PT | ASME B107.2 |
| J7209H | Socket, Impact 3/8" DR 9/32" 6 PT | ASME B107.2 |
| J7210H | Socket, Impact 3/8" DR 5/16" 6 PT | ASME B107.2 |
| J7211H | Socket, Impact 3/8" DR 11/32" 6 PT | ASME B107.2 |
| J7212H | Socket, Impact 3/8" DR 3/8" 6 PT | ASME B107.2 |
| J7214H | Socket, Impact 3/8" DR 7/16" 6 PT | ASME B107.2 |
| J7216H | Socket, Impact 3/8" DR 1/2" 6 PT | ASME B107.2 |
| J7218H | Socket, Impact 3/8" DR 9/16" 6 PT | ASME B107.2 |
| J7220H | Socket, Impact 3/8" DR 5/8" 6 PT | ASME B107.2 |
| J7222H | Socket, Impact 3/8" DR 11/16" 6 PT | ASME B107.2 |
| J7224H | Socket, Impact 3/8" DR 3/4" 6 PT | ASME B107.2 |
| J7226H | Socket, Impact 3/8" DR 13/16" 6 PT | ASME B107.2 |
| J7228H | Socket, Impact 3/8" DR 7/8" 6 PT | ASME B107.2 |
| J7230H | Socket, Impact 3/8" DR 15/16" 6 PT | ASME B107.2 |
| J7232H | Socket, Impact 3/8" DR 1" 6 PT | ASME B107.2 |
| J2587 | Socket, Bar 17" | |
| J2591 | Socket, Clip 3/8" DR | |



3/8" DRIVE 13 PIECE HAND IMPACT DRIVER SET

Product #: J7099A

| Contents | Description |
|----------|-------------------------------------|
| J7099 | Driver, Hand Impact 3/8" DR 5-1/2" |
| J60002 | Bit, Insert #1 Phillips® 1/4" Hex |
| J60008 | Bit, Insert #2 Phillips® 1/4" Hex |
| J60020 | Bit, Insert #3 Phillips® 1/4" Hex |
| J60202 | Bit, Insert 3/16" Slotted 1/4" Hex |
| J60208 | Bit, Insert 9/32" Slotted 1/4" Hex |
| J60050 | Bit, Insert #1 Phillips® 5/16" Hex |
| J60052 | Bit, Insert #2 Phillips® 5/16" Hex |
| J60054 | Bit, Insert #3 Phillips® 5/16" Hex |
| J60256 | Bit, Insert 3/16" Slotted 5/16" Hex |
| J60262 | Bit, Insert 9/32" Slotted 5/16" Hex |
| J6930 | Bit, Holder Power 3/8" DR 5/16" Hex |
| J6931 | Bit, Holder Power 3/8" DR 1/4" Hex |

- › Designed to loosen hard to turn bolts and nuts.
- › Hand impact driver has heavy-duty spring for added torque.
- › Popular interchangeable bits are packaged in plastic blow-molded box for easy storage.
- › Weight (lbs): 2.31



3/8" DRIVE 12 PIECE METRIC THIN WALL DEEP IMPACT SOCKET SET - 6 POINT

Product #: J72217

METRIC



- › Specifically designed for light clearance applications.
- › Reduced wall thickness helps improve access to fasteners in restricted areas.
- › All Impact sockets feature one through hole and a groove to accept a retaining ring and pin to secure the socket to the power tool anvil.
- › Chamfered service ends for quick and positive fastener engagement.
- › Proto® 6 Point Impact Sockets are ideal for use on stubborn or damaged fasteners, and also on fasteners made from soft materials.
- › TorquePlus™ features apply.
- › Designed to fit into smaller spaces.
- › Thinner walls help improve productivity by making it easier to gain access to fasteners in confined spaces.
- › Extra deep length helps improve access in confined areas.
- › Often used in application where fasteners are close together, such as tire service.
- › Weight (lbs): 1.92



| Contents | Description |
|----------|---|
| J7008MHT | Socket, Deep Thin Wall Metric Impact 3/8" DR 8 mm 6 PT |
| J7009MHT | Socket, Deep Thin Wall Metric Impact 3/8" DR 9 mm 6 PT |
| J7010MHT | Socket, Deep Thin Wall Metric Impact 3/8" DR 10 mm 6 PT |
| J7011MHT | Socket, Deep Thin Wall Metric Impact 3/8" DR 11 mm 6 PT |
| J7012MHT | Socket, Deep Thin Wall Metric Impact 3/8" DR 12 mm 6 PT |
| J7013MHT | Socket, Deep Thin Wall Metric Impact 3/8" DR 13 mm 6 PT |
| J7014MHT | Socket, Deep Thin Wall Metric Impact 3/8" DR 14 mm 6 PT |
| J7015MHT | Socket, Deep Thin Wall Metric Impact 3/8" DR 15 mm 6 PT |
| J7016MHT | Socket, Deep Thin Wall Metric Impact 3/8" DR 16 mm 6 PT |
| J7017MHT | Socket, Deep Thin Wall Metric Impact 3/8" DR 17 mm 6 PT |
| J7018MHT | Socket, Deep Thin Wall Metric Impact 3/8" DR 18 mm 6 PT |
| J7019MHT | Socket, Deep Thin Wall Metric Impact 3/8" DR 19 mm 6 PT |



3/8" DRIVE 11 PIECE METRIC IMPACT SOCKET SET - 6 POINT



Product #: J72202



| Contents | Description | ASME Spec. |
|----------|-----------------------------------|---------------|
| J7207M | Socket, Impact 3/8" DR 7 mm 6 PT | ASME B107.33M |
| J7208M | Socket, Impact 3/8" DR 8 mm 6 PT | ASME B107.33M |
| J7209M | Socket, Impact 3/8" DR 9 mm 6 PT | ASME B107.33M |
| J7210M | Socket, Impact 3/8" DR 10 mm 6 PT | ASME B107.33M |
| J7211M | Socket, Impact 3/8" DR 11 mm 6 PT | ASME B107.33M |
| J7212M | Socket, Impact 3/8" DR 12 mm 6 PT | ASME B107.33M |
| J7213M | Socket, Impact 3/8" DR 13 mm 6 PT | ASME B107.33M |
| J7214M | Socket, Impact 3/8" DR 14 mm 6 PT | ASME B107.33M |
| J7215M | Socket, Impact 3/8" DR 15 mm 6 PT | ASME B107.33M |
| J7216M | Socket, Impact 3/8" DR 16 mm 6 PT | ASME B107.33M |
| J7217M | Socket, Impact 3/8" DR 17 mm 6 PT | ASME B107.33M |
| J2585 | Socket, Bar 9" | |
| J2591 | Socket, Clip 3/8" DR | |

- › Proto® 6 Point Impact Sockets are ideal for use on stubborn or damaged fasteners, and also on fasteners made from soft materials.
- › TorquePlus™ features apply.
- › Weight (lbs): 1.14



3/8" DRIVE 11 PIECE METRIC DEEP IMPACT SOCKET SET - 6 POINT



Product #: J72212



- › Proto® 6 Point Impact Sockets are ideal for use on stubborn or damaged fasteners, and also on fasteners made from soft materials.
- › TorquePlus™ features apply.
- › Weight (lbs): 2.71



| Contents | Description | ASME Spec. |
|----------|--|---------------|
| J7007M | Socket, Impact 3/8" DR 7 mm 6 PT Deep | ASME B107.33M |
| J7008M | Socket, Impact 3/8" DR 8 mm 6 PT Deep | ASME B107.33M |
| J7009M | Socket, Impact 3/8" DR 9 mm 6 PT Deep | ASME B107.33M |
| J7010M | Socket, Impact 3/8" DR 10 mm 6 PT Deep | ASME B107.33M |
| J7011M | Socket, Impact 3/8" DR 11 mm 6 PT Deep | ASME B107.33M |
| J7012M | Socket, Impact 3/8" DR 12 mm 6 PT Deep | ASME B107.33M |
| J7013M | Socket, Impact 3/8" DR 13 mm 6 PT Deep | ASME B107.33M |
| J7014M | Socket, Impact 3/8" DR 14 mm 6 PT Deep | ASME B107.33M |
| J7015M | Socket, Impact 3/8" DR 15 mm 6 PT Deep | ASME B107.33M |
| J7016M | Socket, Impact 3/8" DR 16 mm 6 PT Deep | ASME B107.33M |
| J7017M | Socket, Impact 3/8" DR 17 mm 6 PT Deep | ASME B107.33M |
| J2585 | Socket, Bar 9" | |
| J2591 | Socket, Clip 3/8" DR | |

FEATURES AND BENEFITS —

- › High performance drive configuration allows for quick and easy socket engagement to the fastener flats, not the corners.
- › Employs a radius-corner design, shifting contact area and stress away from the fastener corners and distributing contact stresses over a large area of the socket, minimizing slippage.
- › The internal design minimizes fastener rounding, helps to extend fastener life, and allows the user to more easily turn worn, rounded, or rusted fasteners.



3/8" DRIVE 9 PIECE IMPACT SOCKET SET - 6 POINT

Product #: **J72102**



- ▶ Proto® 6 Point Impact Sockets are ideal for use on stubborn or damaged fasteners, and also on fasteners made from soft materials.
- ▶ TorquePlus™ features apply.
- ▶ Weight (lbs): 1.07



| Contents | Description | ASME Spec. |
|----------|------------------------------------|-------------|
| J7208H | Socket, Impact 3/8" DR 1/4" 6 PT | ASME B107.2 |
| J7210H | Socket, Impact 3/8" DR 5/16" 6 PT | ASME B107.2 |
| J7212H | Socket, Impact 3/8" DR 3/8" 6 PT | ASME B107.2 |
| J7216H | Socket, Impact 3/8" DR 1/2" 6 PT | ASME B107.2 |
| J7218H | Socket, Impact 3/8" DR 9/16" 6 PT | ASME B107.2 |
| J7220H | Socket, Impact 3/8" DR 5/8" 6 PT | ASME B107.2 |
| J7222H | Socket, Impact 3/8" DR 11/16" 6 PT | ASME B107.2 |
| J7224H | Socket, Impact 3/8" DR 3/4" 6 PT | ASME B107.2 |
| J7214H | Socket, Impact 3/8" DR 7/16" 6 PT | ASME B107.2 |
| J2585 | Socket, Bar 9" | |
| J2591 | Socket, Clip 3/8" DR | |

3/8" DRIVE 9 PIECE DEEP IMPACT SOCKET SET - 6 POINT

Product #: **J72112**



- ▶ Proto® 6 Point Impact Sockets are ideal for use on stubborn or damaged fasteners, and also on fasteners made from soft materials.
- ▶ TorquePlus™ features apply.
- ▶ Weight (lbs): 2.42



| Contents | Description | ASME Spec. |
|----------|---|-------------|
| J7708H | Socket, Impact 3/8" DR 1/4" 6 PT Deep | ASME B107.2 |
| J7710H | Socket, Impact 3/8" DR 5/16" 6 PT Deep | ASME B107.2 |
| J7712H | Socket, Impact 3/8" DR 3/8" 6 PT Deep | ASME B107.2 |
| J7714H | Socket, Impact 3/8" DR 7/16" 6 PT Deep | ASME B107.2 |
| J7716H | Socket, Impact 3/8" DR 1/2" 6 PT Deep | ASME B107.2 |
| J7718H | Socket, Impact 3/8" DR 9/16" 6 PT Deep | ASME B107.2 |
| J7720H | Socket, Impact 3/8" DR 5/8" 6 PT Deep | ASME B107.2 |
| J7722H | Socket, Impact 3/8" DR 11/16" 6 PT Deep | ASME B107.2 |
| J7724H | Socket, Impact 3/8" DR 3/4" 6 PT Deep | ASME B107.2 |
| J2585 | Socket, Bar 9" | |
| J2591 | Socket, Clip 3/8" DR | |

3/8" DRIVE 9 PIECE THIN WALL DEEP IMPACT SOCKET SET - 6 POINT

Product #: J72117



- › Specifically designed for light clearance applications.
- › Reduced wall thickness helps improve access to fasteners in restricted areas.
- › All impact sockets feature one through hole and a groove to accept a retaining ring and pin to secure the socket to the power tool anvil.
- › Chamfered service ends for quick and positive fastener engagement.
- › Proto® 6 Point Impact Sockets are ideal for use on stubborn or damaged fasteners, and also on fasteners made from soft materials.
- › TorquePlus™ features apply.
- › Thin wall sockets are lightweight.
- › Extra deep length helps improve access in confined areas.
- › Often used in application where fasteners are close together, such as tire service.
- › Weight (lbs): 1.54



| Contents | Description | ASME Spec. |
|----------|---|-------------|
| J7708HT | Socket, Impact Deep Thin Wall 3/8" DR 1/4" 6 PT | ASME B107.2 |
| J7710HT | Socket, Impact Deep Thin Wall 3/8" DR 5/16" 6 PT | ASME B107.2 |
| J7712HT | Socket, Impact Deep Thin Wall 3/8" DR 3/8" 6 PT | ASME B107.2 |
| J7714HT | Socket, Impact Deep Thin Wall 3/8" DR 7/16" 6 PT | ASME B107.2 |
| J7716HT | Socket, Impact Deep Thin Wall 3/8" DR 1/2" 6 PT | ASME B107.2 |
| J7718HT | Socket, Impact Deep Thin Wall 3/8" DR 9/16" 6 PT | ASME B107.2 |
| J7720HT | Socket, Impact Deep Thin Wall 3/8" DR 5/8" 6 PT | ASME B107.2 |
| J7722HT | Socket, Impact Deep Thin Wall 3/8" DR 11/16" 6 PT | ASME B107.2 |
| J7724HT | Socket, Impact Deep Thin Wall 3/8" DR 3/4" 6 PT | ASME B107.2 |

3/8" DRIVE 7 PIECE TORX® BIT SET

Product #: J4739P



| Contents | Description | Torx® Size |
|----------|------------------------------------|------------|
| J60508 | Bit, Insert T10 Torx® 1/4" Hex | T10 |
| J60510 | Bit, Insert T15 Torx® 1/4" Hex | T15 |
| J60512 | Bit, Insert T20 Torx® 1/4" Hex | T20 |
| J60514 | Bit, Insert T25 Torx® 1/4" Hex | T25 |
| J60516 | Bit, Insert T27 Torx® 1/4" Hex | T27 |
| J60518 | Bit, Insert T30 Torx® 1/4" Hex | T30 |
| J6931 | Bit Holder, Power 3/8" DR 1/4" Hex | |
| J25TR50C | Pouch | |

- › Not for use on impact applications.
- › 3/8" DR, 5/16" Hex.
- › Weight (lbs): 0.19



3/8" DRIVE 7 PIECE TORX® IMPACT SOCKET SET

Product #: J72132



| Contents | Description | Torx® Size |
|----------|----------------------------------|------------|
| J7206TX | Socket, Impact 3/8" DR E6 Torx® | E6 |
| J7207TX | Socket, Impact 3/8" DR E7 Torx® | E7 |
| J7208TX | Socket, Impact 3/8" DR E8 Torx® | E8 |
| J7210TX | Socket, Impact 3/8" DR E10 Torx® | E10 |
| J7212TX | Socket, Impact 3/8" DR E12 Torx® | E12 |
| J7214TX | Socket, Impact 3/8" DR E14 Torx® | E14 |
| J7216TX | Socket, Impact 3/8" DR E16 Torx® | E16 |
| J2584 | Socket, Bar 6-1/4" | |
| J2591 | Socket, Clip 3/8" DR | |

- › Proto® Torx® Impact Sockets can be used on stubborn Torx® fasteners.
- › Tight tolerances for snug fit on fastener.
- › Torx® impact sockets are used wherever powered drive tools are used to install or remove fasteners.
- › Torx® impact sockets are designed to withstand the high torque and force associated with impact tools in repetitive application.
- › Weight (lbs): 0.62



3/8" AND 1/2" DRIVE 10 PIECE HEX BIT IMPACT SOCKET SET

Product #: J72156

- ▶ Proto® Hex Bit Impact Sockets can be used on stubborn fasteners.
- ▶ Drive end chamfer and four detents help provide quick positive engagement with drive tool on any of the socket drive walls.
- ▶ Large clearance holes, concentric opening and nut end chamfer make it easy to position socket on fasteners.
- ▶ Made from high strength steel to help minimize wall thickness and provide access to fasteners in recesses and where nuts and bolts protrude.
- ▶ Impact sockets are used wherever powered drive tools are used to install or remove fasteners.
- ▶ Impact sockets are designed to withstand higher torque and force associated with impact tools in repetitive application.
- ▶ Tight tolerances for snug fit on fastener.
- ▶ Hex bit impact sockets are used wherever powered drive tools are used to install or remove fasteners.
- ▶ Hex bit impact sockets are designed to withstand the high torque and force associated with impact tools in repetitive application.
- ▶ Side locking hole.
- ▶ Weight (lbs): 2.56

| Contents | Description |
|-----------|---------------------------------------|
| J72901/8 | Socket, Impact Hex Bit 3/8" DR 1/8" |
| J72905/32 | Socket, Impact Hex Bit 3/8" DR 5/32" |
| J72903/16 | Socket, Impact Hex Bit 3/8" DR 13/16" |
| J72907/32 | Socket, Impact Hex Bit 3/8" DR 7/32" |
| J72901/4 | Socket, Impact Hex Bit 3/8" DR 1/4" |
| J72905/16 | Socket, Impact Hex Bit 3/8" DR 5/16" |
| J72903/8 | Socket, Impact Hex Bit 3/8" DR 3/8" |
| J74411/2 | Socket, Impact Hex Bit 1/2" DR 1/2" |
| J74419/16 | Socket, Impact Hex Bit 1/2" DR 9/16" |
| J74415/8 | Socket, Impact Hex Bit 1/2" DR 5/8" |
| J4968PB | Blow-Molded Case |



3/8" DRIVE 7 PIECE HEX BIT IMPACT SOCKET SET

Product #: J72152

- ▶ Proto® Hex Bit Impact Sockets can be used on stubborn fasteners.
- ▶ Tight tolerances for snug fit on fastener.
- ▶ Hex bit impact sockets are used wherever powered drive tools are used to install or remove fasteners.
- ▶ Hex bit impact sockets are designed to withstand the high torque and force associated with impact tools in repetitive application.
- ▶ Side locking hole.
- ▶ Weight (lbs): 0.79

| Contents | Description |
|-----------|---------------------------------------|
| J72901/8 | Socket, Impact Hex Bit 3/8" DR 1/8" |
| J72905/32 | Socket, Impact Hex Bit 3/8" DR 5/32" |
| J72903/16 | Socket, Impact Hex Bit 3/8" DR 13/16" |
| J72907/32 | Socket, Impact Hex Bit 3/8" DR 7/32" |
| J72901/4 | Socket, Impact Hex Bit 3/8" DR 1/4" |
| J72905/16 | Socket, Impact Hex Bit 3/8" DR 5/16" |
| J72903/8 | Socket, Impact Hex Bit 3/8" DR 3/8" |
| J2585 | Socket, Bar 9" |
| J2591 | Socket, Clip 3/8" DR |



3/8" DRIVE 5 PIECE METRIC HEX BIT IMPACT SOCKET SET

METRIC

Product #: J72252



- › Proto® Hex Bit Impact Sockets can be used on stubborn fasteners.
- › Tight tolerances for snug fit on fastener.
- › Hex bit impact sockets are used wherever powered drive tools are used to install or remove fasteners.
- › Hex bit impact sockets are designed to withstand the high torque and force associated with impact tools in repetitive application.
- › Side locking hole.
- › Weight (lbs): 0.64

| Contents | Description |
|-----------|--------------------------------------|
| J7290-4M | Socket, Impact Hex Bit 3/8" DR 4 mm |
| J7290-5M | Socket, Impact Hex Bit 3/8" DR 5 mm |
| J7290-6M | Socket, Impact Hex Bit 3/8" DR 6 mm |
| J7290-8M | Socket, Impact Hex Bit 3/8" DR 8 mm |
| J7290-10M | Socket, Impact Hex Bit 3/8" DR 10 mm |
| J2584 | Socket, Bar 6-1/4" |
| J2591 | Socket, Clip 3/8" DR |



3/8" DRIVE 5 PIECE IMPACT UNIVERSAL SOCKET SET - 6 POINT

Product #: J72142



- › Ball and spring design which allows for a 30° working angle.
- › Smooth 360° rotation.
- › Proto® 6 Point Impact Sockets are ideal for use on stubborn or damaged fasteners, and also on fasteners made from soft materials.
- › TorquePlus™ features apply.
- › Weight (lbs): 1.29



| Contents | Description | ASME Spec. |
|----------|---|-------------|
| J77273P | Socket, Impact 3/8" DR Universal 3/8" 6 PT | ASME B107.2 |
| J77274P | Socket, Impact 3/8" DR Universal 7/16" 6 PT | ASME B107.2 |
| J77275P | Socket, Impact 3/8" DR Universal 1/2" 6 PT | ASME B107.2 |
| J77276P | Socket, Impact 3/8" DR Universal 9/16" 6 PT | ASME B107.2 |
| J77277P | Socket, Impact 3/8" DR Universal 5/8" 6 PT | ASME B107.2 |
| J2584 | Socket, Bar 6-1/4" | |
| J2591 | Socket, Clip 3/8" DR | |

3/8" DRIVE 10 PIECE METRIC IMPACT UNIVERSAL SOCKET SET - 6 POINT

METRIC

Product #: J72133M



| Contents | Description |
|----------|---|
| J77408MP | Socket, Impact 3/8" DR Universal 8 mm 6 PT |
| J77410MP | Socket, Impact 3/8" DR Universal 10 mm 6 PT |
| J77411MP | Socket, Impact 3/8" DR Universal 11 mm 6 PT |
| J77412MP | Socket, Impact 3/8" DR Universal 12 mm 6 PT |
| J77413MP | Socket, Impact 3/8" DR Universal 13 mm 6 PT |
| J77414MP | Socket, Impact 3/8" DR Universal 14 mm 6 PT |
| J77415MP | Socket, Impact 3/8" DR Universal 15 mm 6 PT |
| J77416MP | Socket, Impact 3/8" DR Universal 16 mm 6 PT |
| J77417MP | Socket, Impact 3/8" DR Universal 17 mm 6 PT |
| J77418MP | Socket, Impact 3/8" DR Universal 18 mm 6 PT |
| J2591 | Socket, Clip 3/8" DR |
| J2585 | Socket, Bar 9" |

- › Universal Sockets: 8, 10, 11, 12, 13, 14, 15, 16, 17, 18, 19 mm.
- › Accessories: Socket Clip, and Socket Rail.
- › Weight (lbs): 2.40



3/8" DRIVE 10 PIECE DEEP METRIC IMPACT UNIVERSAL SOCKET SET - 6 POINT

METRIC

Product #: J72135M



| Contents | Description |
|----------|---|
| J78410MP | Socket, Impact 3/8" DR Universal 10 mm 6 PT |
| J78411MP | Socket, Impact 3/8" DR Universal 11 mm 6 PT |
| J78412MP | Socket, Impact 3/8" DR Universal 12 mm 6 PT |
| J78413MP | Socket, Impact 3/8" DR Universal 13 mm 6 PT |
| J78414MP | Socket, Impact 3/8" DR Universal 14 mm 6 PT |
| J78415MP | Socket, Impact 3/8" DR Universal 15 mm 6 PT |
| J78416MP | Socket, Impact 3/8" DR Universal 16 mm 6 PT |
| J78417MP | Socket, Impact 3/8" DR Universal 17 mm 6 PT |
| J78418MP | Socket, Impact 3/8" DR Universal 18 mm 6 PT |
| J78419MP | Socket, Impact 3/8" DR Universal 19 mm 6 PT |
| J2591 | Socket, Clip 3/8" DR |
| J2585 | Socket, Bar 9" |

- › Universal, Sockets: 10, 11, 12, 13, 14, 15, 16, 17, 18, 19 mm.
- › Accessories: Socket Clip, and Socket Rail.
- › Weight (lbs): 3.08



3/8" DRIVE 10 PIECE METRIC UNIVERSAL IMPACT SOCKET SET - 12 POINT

Product #: J72137M



| Contents | Description |
|----------|--|
| J77510MP | Socket, Impact 3/8" DR Universal 10 mm 12 PT |
| J77511MP | Socket, Impact 3/8" DR Universal 11 mm 12 PT |
| J77512MP | Socket, Impact 3/8" DR Universal 12 mm 12 PT |
| J77513MP | Socket, Impact 3/8" DR Universal 13 mm 12 PT |
| J77514MP | Socket, Impact 3/8" DR Universal 14 mm 12 PT |
| J77515MP | Socket, Impact 3/8" DR Universal 15 mm 12 PT |
| J77516MP | Socket, Impact 3/8" DR Universal 16 mm 12 PT |
| J77517MP | Socket, Impact 3/8" DR Universal 17 mm 12 PT |
| J77518MP | Socket, Impact 3/8" DR Universal 18 mm 12 PT |
| J77519MP | Socket, Impact 3/8" DR Universal 19 mm 12 PT |
| J2591 | Socket, Clip 3/8" DR |
| J2585 | Socket, Bar 9" |

- › Universal Sockets: 10, 11, 12, 13, 14, 15, 16, 17, 18, 19 mm.
- › Accessories: Socket Clip, and Socket Rail.
- › Weight (lbs): 3.08



3/8" DRIVE 3 PIECE IMPACT LOCKING EXTENSION SET

Product #: J7277L



- › Weight (lbs): 1.25

| Contents | Description |
|----------|---------------------------------------|
| J7203L | Extension, Impact 3/8" DR Locking 3" |
| J7206L | Extension, Impact 3/8" DR Locking 6" |
| J7212L | Extension, Impact 3/8" DR Locking 12" |





3/8" DRIVE IMPACT SOCKETS - 6 POINT

- ▶ Proto® 6 Point Impact Sockets are ideal for use on stubborn or damaged fasteners, and also on fasteners made from soft materials.
- ▶ TorquePlus™ features apply.
- ▶ Size stamped on tool for easy identification.
- ▶ Side locking hole.

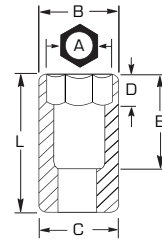

| Product # | Size (in) | Nut End Outside Dia. (in) (A) | Drive End Outside Dia. (in) (B) | Nut Depth (in) (C) | Bolt Clearance Depth (in) (D) | Overall Length (in) (E) | Weight (lbs) |
|-----------|-----------|-------------------------------|---------------------------------|--------------------|-------------------------------|-------------------------|--------------|
| J7208H | 1/4 | 7/16 | 11/16 | 9/32 | 19/32 | 1-3/32 | 0.07 |
| J7209H | 9/32 | 31/64 | 11/16 | 5/16 | 19/32 | 1-3/32 | 0.07 |
| J7210H | 5/16 | 1/2 | 11/16 | 5/16 | 19/32 | 1-3/32 | 0.07 |
| J7211H | 11/32 | 35/64 | 11/16 | 3/8 | 19/32 | 1-3/32 | 0.07 |
| J7212H | 3/8 | 19/32 | 11/16 | 3/8 | 19/32 | 1-3/32 | 0.07 |
| J7214H | 7/16 | 11/16 | 11/16 | 3/8 | 19/32 | 1-3/32 | 0.06 |
| J7216H | 1/2 | 3/4 | 3/4 | 3/8 | 19/32 | 1-3/32 | 0.08 |
| J7218H | 9/16 | 13/16 | 13/16 | 9/16 | 19/32 | 1-3/32 | 0.11 |
| J7220H | 5/8 | 29/32 | 29/32 | 9/16 | 19/32 | 1-3/32 | 0.12 |
| J7222H | 11/16 | 1 | 1 | 9/16 | 19/32 | 1-3/32 | 0.15 |
| J7224H | 3/4 | 1-1/16 | 1-1/16 | 17/32 | 19/32 | 1-3/32 | 0.16 |
| J7226H | 13/16 | 1-3/16 | 1-13/64 | 11/16 | 23/32 | 1-7/32 | 0.24 |
| J7228H | 7/8 | 1-9/32 | 1-9/32 | 11/16 | 23/32 | 1-7/32 | 0.26 |
| J7230H | 15/16 | 1-23/64 | 1-23/64 | 51/64 | 27/32 | 1-11/32 | 0.35 |
| J7232H | 1 | 1-1/2 | 1-1/2 | 51/64 | 27/32 | 1-11/32 | 0.42 |

ASME B107.2

3/8" DRIVE METRIC IMPACT SOCKETS - 6 POINT



- ▶ Proto® 6 Point Impact Sockets are ideal for use on stubborn or damaged fasteners, and also on fasteners made from soft materials.
- ▶ TorquePlus™ features apply.
- ▶ Socket size stamped on tool for easy identification.
- ▶ Side locking hole.



| Product # | Size (mm) (A) | Nut End Outside Dia. (in) (B) | Drive End Outside Dia. (in) (C) | Nut Depth (in) (D) | Bolt Clearance Depth (in) (E) | Overall Length (in) (L) | Weight (lbs) |
|-----------|---------------|-------------------------------|---------------------------------|--------------------|-------------------------------|-------------------------|--------------|
| J7206M | 6 | 27/64 | 11/16 | 7/32 | 27/64 | 59/64 | 0.06 |
| J7207M | 7 | 31/64 | 11/16 | 15/64 | 27/64 | 59/64 | 0.06 |
| J7208M | 8 | 33/64 | 11/16 | 5/16 | 17/32 | 1-1/32 | 0.06 |
| J7209M | 9 | 37/64 | 11/16 | 11/32 | 17/32 | 1-1/32 | 0.06 |
| J7210M | 10 | 11/16 | 11/16 | 3/8 | 17/32 | 1-1/32 | 0.06 |
| J7211M | 11 | 11/16 | 11/16 | 13/32 | 17/32 | 1-1/32 | 0.06 |
| J7212M | 12 | 23/32 | 23/32 | 7/16 | 17/32 | 1-1/32 | 0.07 |
| J7213M | 13 | 3/4 | 3/4 | 7/16 | 17/32 | 1-3/32 | 0.08 |
| J7214M | 14 | 13/16 | 13/16 | 9/16 | 19/32 | 1-3/32 | 0.09 |
| J7215M | 15 | 55/64 | 55/64 | 9/16 | 19/32 | 1-3/32 | 0.10 |
| J7216M | 16 | 29/32 | 29/32 | 9/16 | 19/32 | 1-3/32 | 0.12 |
| J7217M | 17 | 1 | 1 | 9/16 | 19/32 | 1-3/32 | 0.15 |
| J7218M | 18 | 1-1/32 | 1-1/32 | 9/16 | 19/32 | 1-3/32 | 0.16 |
| J7219M | 19 | 1-1/16 | 1-1/16 | 17/32 | 19/32 | 1-3/32 | 0.15 |
| J7220M | 20 | 1-7/64 | 1-7/64 | 17/32 | 19/32 | 1-3/32 | 0.18 |
| J7221M | 21 | 1-5/32 | 1-5/32 | 17/32 | 19/32 | 1-3/32 | 0.19 |
| J7222M | 22 | 1-13/64 | 1-13/64 | 17/32 | 19/32 | 1-3/32 | 0.20 |
| J7223M | 23 | 1-1/4 | 1-1/4 | 17/32 | 19/32 | 1-3/32 | 0.26 |
| J7224M | 24 | 1-19/64 | 1-19/64 | 17/32 | 19/32 | 1-3/32 | 0.27 |

ASME B107.33M



3/8" DRIVE DEEP IMPACT SOCKETS - 6 POINT

- ▶ Proto® 6 Point Impact Sockets are ideal for use on stubborn or damaged fasteners, and also on fasteners made from soft materials.
- ▶ TorquePlus™ features apply.
- ▶ Socket size stamped on tool for easy identification.
- ▶ Side locking hole.

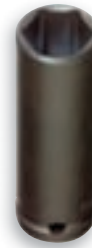

| Product # | Size (in) (A) | Nut End Outside Dia. (in) (B) | Drive End Outside Dia. (in) (C) | Nut Depth (in) (D) | Bolt Clearance Depth (in) (E) | Overall Length (in) (L) | Weight (lbs) |
|-----------|---------------|-------------------------------|---------------------------------|--------------------|-------------------------------|-------------------------|--------------|
| J7708H | 1/4 | 7/16 | 11/16 | 9/32 | 2-1/4 | 2-3/4 | 0.21 |
| J7709H | 9/32 | 31/64 | 11/16 | 5/16 | 2-1/4 | 2-3/4 | 0.18 |
| J7710H | 5/16 | 33/64 | 11/16 | 21/64 | 2-1/4 | 2-3/4 | 0.20 |
| J7711H | 11/32 | 35/64 | 11/16 | 11/32 | 2-1/4 | 2-3/4 | 0.19 |
| J7712H | 3/8 | 19/32 | 11/16 | 3/8 | 2-1/4 | 2-3/4 | 0.19 |
| J7714H | 7/16 | 11/16 | 11/16 | 27/64 | 2-1/4 | 2-3/4 | 0.17 |
| J7716H | 1/2 | 3/4 | 3/4 | 15/32 | 2-1/4 | 2-3/4 | 0.21 |
| J7718H | 9/16 | 13/16 | 13/16 | 11/16 | 2-1/4 | 2-3/4 | 0.22 |
| J7720H | 5/8 | 29/32 | 29/32 | 11/16 | 2-1/4 | 2-3/4 | 0.29 |
| J7722H | 11/16 | 1 | 1 | 11/16 | 2-1/4 | 2-3/4 | 0.34 |
| J7724H | 3/4 | 1-1/16 | 1-1/16 | 43/64 | 2-1/4 | 2-3/4 | 0.38 |
| J7726H | 13/16 | 1-13/64 | 1-13/64 | 13/16 | 2-1/8 | 2-3/4 | 0.53 |
| J7728H | 7/8 | 1-9/32 | 1-9/32 | 13/16 | 2-1/8 | 2-3/4 | 0.59 |
| J7730H | 15/16 | 1-23/64 | 1-23/64 | 13/16 | 2-1/8 | 2-3/4 | 0.66 |
| J7732H | 1 | 1-1/2 | 1-1/2 | 13/16 | 2-1/8 | 2-3/4 | 0.85 |



ASME B107.2

3/8" DRIVE METRIC DEEP IMPACT SOCKETS - 6 POINT

- ▶ Proto® 6 Point Impact Sockets are ideal for use on stubborn or damaged fasteners, and also on fasteners made from soft materials.
- ▶ TorquePlus™ features apply.
- ▶ Size stamped on tool for easy identification.
- ▶ Side locking hole.



METRIC

| Product # | Size (mm) (A) | Nut End Outside Dia. (in) (B) | Drive End Outside Dia. (in) (C) | Nut Depth (in) (D) | Bolt Clearance Depth (in) (E) | Overall Length (in) (L) | Weight (lbs) |
|-----------|---------------|-------------------------------|---------------------------------|--------------------|-------------------------------|-------------------------|--------------|
| J7006M | 6 | 27/64 | 11/16 | 9/32 | 2-1/4 | 2-3/4 | 0.19 |
| J7007M | 7 | 31/64 | 11/16 | 5/16 | 2-1/4 | 2-3/4 | 0.20 |
| J7008M | 8 | 33/64 | 11/16 | 5/16 | 2-1/4 | 2-3/4 | 0.19 |
| J7009M | 9 | 37/64 | 11/16 | 3/8 | 2-1/4 | 2-3/4 | 0.20 |
| J7010M | 10 | 5/8 | 11/16 | 3/8 | 2-1/4 | 2-3/4 | 0.19 |
| J7011M | 11 | 11/16 | 11/16 | 13/32 | 2-1/4 | 2-3/4 | 0.18 |
| J7012M | 12 | 3/4 | 3/4 | 7/16 | 2-1/4 | 2-3/4 | 0.20 |
| J7013M | 13 | 3/4 | 3/4 | 15/32 | 2-1/4 | 2-3/4 | 0.22 |
| J7014M | 14 | 13/16 | 13/16 | 1/2 | 2-1/4 | 2-3/4 | 0.22 |
| J7015M | 15 | 55/64 | 55/64 | 11/16 | 2-1/4 | 2-3/4 | 0.25 |
| J7016M | 16 | 29/32 | 29/32 | 11/16 | 2-1/4 | 2-3/4 | 0.29 |
| J7017M | 17 | 1 | 1 | 11/16 | 2-1/4 | 2-3/4 | 0.37 |
| J7018M | 18 | 1-1/32 | 1-1/32 | 11/16 | 2-1/4 | 2-3/4 | 0.38 |
| J7019M | 19 | 1-1/16 | 1-1/16 | 11/16 | 2-1/4 | 2-3/4 | 0.38 |
| J7020M | 20 | 1-7/64 | 1-7/64 | 25/32 | 2-1/4 | 2-3/4 | 0.42 |
| J7021M | 21 | 1-5/32 | 1-5/32 | 25/32 | 2-1/4 | 2-3/4 | 0.46 |
| J7022M | 22 | 1-13/64 | 1-13/64 | 51/64 | 2-1/4 | 2-3/4 | 0.49 |
| J7023M | 23 | 1-1/4 | 1-1/4 | 51/64 | 2-1/4 | 2-3/4 | 0.53 |
| J7024M | 24 | 1-19/64 | 1-19/64 | 59/64 | 2-1/4 | 2-3/4 | 0.58 |



ASME B107.33M



3/8" DRIVE DEEP THIN WALL IMPACT SOCKETS - 6 POINT

- › Specifically designed for light clearance applications.
- › Reduced wall thickness helps improve access to fasteners in restricted areas.
- › All Impact sockets feature one through hole and a groove to accept a retaining ring and pin to secure the socket to the power tool anvil.
- › Chamfered service ends for quick and positive fastener engagement.
- › Proto® 6 Point Impact Sockets are ideal for use on stubborn or damaged fasteners, and also on fasteners made from soft materials.
- › TorquePlus™ features apply.
- › Thin wall sockets are lightweight.
- › Designed to fit into smaller spaces.
- › Thinner walls help improve productivity by making it easier to gain access to fasteners in confined spaces.
- › Extra deep length helps improve access in confined areas.
- › Often used in application where fasteners are close together, such as tire service.



| Product # | Size (in) (A) | Nut End Outside Dia. (in) (B) | Drive End Outside Dia. (in) (C) | Nut Depth (in) (D) | Bolt Clearance Depth (in) (E) | Overall Length (in) (L) | Weight (lbs) |
|-----------|---------------|-------------------------------|---------------------------------|--------------------|-------------------------------|-------------------------|--------------|
| J7708HT | 1/4 | 27/64 | 11/16 | 9/32 | 2-1/4 | 2 | 0.15 |
| J7710HT | 5/16 | 31/64 | 11/16 | 1/4 | 2-1/4 | 2 | 0.14 |
| J7711HT | 11/32 | 1/2 | 11/16 | 9/32 | 2-1/4 | 2 | 0.13 |
| J7712HT | 3/8 | 37/64 | 11/16 | 5/16 | 2-1/4 | 1-3/4 | 0.13 |
| J7714HT | 7/16 | 41/64 | 11/16 | 11/32 | 2-1/4 | 1-3/4 | 0.11 |
| J7716HT | 1/2 | 23/32 | 23/32 | 13/32 | 2-1/4 | 1-3/4 | 0.14 |
| J7718HT | 9/16 | 25/32 | 25/32 | 1/2 | 2-1/4 | 2 | 0.15 |
| J7720HT | 5/8 | 7/8 | 7/8 | 1/2 | 2-1/4 | 2-1/8 | 0.18 |
| J7722HT | 11/16 | 15/16 | 15/16 | 1/2 | 2-1/4 | 2-7/32 | 0.22 |
| J7724HT | 3/4 | 1 | 1 | 17/32 | 2-1/4 | 2-1/4 | 0.27 |
| J7728HT | 7/8 | 1-7/32 | 1-7/32 | 13/16 | 2-1/8 | 2-1/2 | 0.43 |
| J7730HT | 15/16 | 1-1/4 | 1-1/4 | 13/16 | 2-1/8 | 2-27/32 | 0.54 |



ASME B107.2

3/8" DRIVE METRIC DEEP THIN WALL IMPACT SOCKETS - 6 POINT

- › Specifically designed for light clearance applications.
- › Reduced wall thickness helps improve access to fasteners in restricted areas.
- › All Impact sockets feature one through hole and a groove to accept a retaining ring and pin to secure the socket to the power tool anvil.
- › Chamfered service ends for quick and positive fastener engagement.
- › Proto® 6 Point Impact Sockets are ideal for use on stubborn or damaged fasteners, and also on fasteners made from soft materials.
- › TorquePlus™ features apply.
- › Thin wall sockets are lightweight.
- › Designed to fit into smaller spaces.
- › Thinner walls help improve productivity by making it easier to gain access to fasteners in confined spaces.
- › Extra deep length helps improve access in confined areas.
- › Often used in application where fasteners are close together, such as tire service.



| Product # | Size (mm) (A) | Nut End Outside Dia. (in) (B) | Drive End Outside Dia. (in) (C) | Nut Depth (in) (D) | Bolt Clearance Depth (in) (E) | Overall Length (in) (L) | Weight (lbs) |
|-----------|---------------|-------------------------------|---------------------------------|--------------------|-------------------------------|-------------------------|--------------|
| J7008MHT | 8 | 31/64 | 11/16 | 1/4 | 1-1/4 | 2 | 0.11 |
| J7009MHT | 9 | 17/32 | 11/16 | 5/16 | 1-3/16 | 2 | 0.15 |
| J7010MHT | 10 | 19/32 | 11/16 | 11/32 | 1-5/32 | 2 | 0.11 |
| J7011MHT | 11 | 11/16 | 11/16 | 21/64 | 1-11/64 | 2 | 0.12 |
| J7012MHT | 12 | 11/16 | 11/16 | 3/8 | 1-1/8 | 2 | 0.11 |
| J7013MHT | 13 | 45/64 | 45/64 | 13/32 | 1-3/32 | 2 | 0.11 |
| J7014MHT | 14 | 25/32 | 25/32 | 15/32 | 1-1/32 | 2 | 0.14 |
| J7015MHT | 15 | 53/64 | 53/64 | 1/2 | 1 | 2 | 0.18 |
| J7016MHT | 16 | 7/8 | 7/8 | 1/2 | 1 | 2 | 0.17 |
| J7017MHT | 17 | 1 | 1 | 1/2 | 1 | 2 | 0.20 |
| J7018MHT | 18 | 31/32 | 31/32 | 1/2 | 1 | 2 | 0.20 |
| J7019MHT | 19 | 1 | 1 | 17/32 | 31/32 | 2 | 0.25 |



3/8" DRIVE HIGH STRENGTH MAGNETIC IMPACT SOCKETS - 6 POINT

- ▶ ProtoGrip™ Magnetic Sockets use high-strength magnets made from a rare earth magnet alloy/nylon blend.
- ▶ ProtoGrip™ Magnetic Sockets require no bushings to hold the magnet in place. This allows room for more magnet material, helping increase total magnetic strength.
- ▶ Designed to easily pick up heavy fasteners and hold them tightly during use.
- ▶ Strong magnetic hold helps increase efficiency when installing fasteners in awkward or hard-to-reach locations.
- ▶ Impact sockets with high impact strength are used in automated and hand impact socket applications.
- ▶ Socket size stamped on tool for easy identification.
- ▶ Side locking hole.



| Product # | Size (in) | Nut End Outside Dia. (in) (B) | Drive End Outside Dia. (in) (C) | Nut Depth (in) (D) | Overall Length (in) (L) | Weight (lbs) |
|-----------|-----------|-------------------------------|---------------------------------|--------------------|-------------------------|--------------|
| J7208HF | 1/4 | 7/16 | 11/16 | 11/64 | 1-3/32 | 0.07 |
| J7210HF | 5/16 | 1/2 | 11/16 | 3/16 | 1-3/32 | 0.08 |
| J7212HF | 3/8 | 39/64 | 11/16 | 15/64 | 1-3/32 | 0.08 |
| J7214HF | 7/16 | 11/16 | 11/16 | 1/4 | 1-3/32 | 0.08 |
| J7216HF | 1/2 | 3/4 | 3/4 | 9/32 | 1-3/32 | 0.08 |
| J7218HF | 9/16 | 13/16 | 13/16 | 21/64 | 1-3/32 | 0.12 |
| J7220HF | 5/8 | 29/32 | 29/32 | 23/64 | 1-7/32 | 0.16 |



ASME B107.33M

3/8" DRIVE METRIC HIGH STRENGTH MAGNETIC IMPACT SOCKETS - 6 POINT

METRIC

- ▶ ProtoGrip™ Magnetic Sockets use high-strength magnets made from a rare earth magnet alloy/nylon blend.
- ▶ ProtoGrip™ Magnetic Sockets require no bushings to hold the magnet in place. This allows room for more magnet material, helping increase total magnetic strength.
- ▶ Designed to easily pick up heavy fasteners and hold them tightly during use.
- ▶ Strong magnetic hold helps increase efficiency when installing fasteners in awkward or hard-to-reach locations.
- ▶ Impact sockets with high impact strength are used in automated and hand impact socket applications.
- ▶ Socket size stamped on tool for easy identification.
- ▶ Side locking hole.



| Product # | Size (mm) | Nut End Outside Dia. (in) (B) | Drive End Outside Dia. (in) (C) | Nut Depth (in) (D) | Overall Length (in) (L) | Weight (lbs) |
|-----------|-----------|-------------------------------|---------------------------------|--------------------|-------------------------|--------------|
| J7207MHF | 7 | 31/64 | 11/16 | 11/64 | 1-3/32 | 0.08 |
| J7208MHF | 8 | 1/2 | 11/16 | 11/64 | 1-3/32 | 0.07 |
| J7210MHF | 10 | 5/8 | 11/16 | 7/32 | 1-9/64 | 0.08 |
| J7211MHF | 11 | 11/16 | 11/16 | 17/64 | 1-9/64 | 0.08 |
| J7212MHF | 12 | 47/64 | 47/64 | 9/32 | 1-9/64 | 0.09 |
| J7213MHF | 13 | 3/4 | 3/4 | 19/64 | 1-13/64 | 0.10 |
| J7214MHF | 14 | 13/16 | 13/16 | 21/64 | 1-13/64 | 0.12 |
| J7215MHF | 15 | 55/64 | 55/64 | 21/64 | 1-13/64 | 0.14 |
| J7217MHF | 17 | 1 | 1 | 25/64 | 1-1/4 | 0.20 |
| J7218MHF | 18 | 1-1/32 | 1-1/32 | 25/64 | 1-1/4 | 0.21 |



ASME B107.33

3/8" DRIVE IMPACT SOCKETS - 8 POINT

- ▶ Proto® 8 Point Impact Sockets are ideal for use on stubborn or damaged fasteners, and also on fasteners made from soft materials.
- ▶ TorquePlus™ features apply.
- ▶ Drive end chamfer and four detents help provide quick positive engagement with drive tool on any of the socket drive walls.
- ▶ Tight tolerances for snug fit on fastener.
- ▶ Large clearance holes, concentric opening and nut end chamfer make it easy to position socket on fasteners.
- ▶ Made from high strength steel to help minimize wall thickness and provide access to fasteners in recesses and where nuts and bolts protrude.
- ▶ Impact sockets are used wherever powered drive tools are used to install or remove fasteners.
- ▶ Impact sockets are designed to withstand higher torque and force associated with impact tools in repetitive application.
- ▶ Socket size stamped on tool for easy identification.
- ▶ Side locking hole.



| Product # | Size (in) (A) | Nut End Outside Dia. (in) (B) | Drive End Outside Dia. (in) (C) | Nut Depth (in) (D) | Bolt Clearance Depth (in) (E) | Overall Length (in) (L) | Weight (lbs) |
|-----------|---------------|-------------------------------|---------------------------------|--------------------|-------------------------------|-------------------------|--------------|
| J7208S | 1/4 | 31/64 | 11/16 | 1/4 | 1/2 | 1 | 0.07 |
| J7210S | 5/16 | 5/8 | 11/16 | 9/32 | 1/2 | 1 | 0.06 |
| J7212S | 3/8 | 11/16 | 11/16 | 5/16 | 1/2 | 1 | 0.06 |
| J7214S | 7/16 | 13/16 | 13/16 | 21/64 | 1/2 | 1 | 0.10 |
| J7216S | 1/2 | 59/64 | 15/16 | 3/8 | 9/16 | 1-1/16 | 0.13 |
| J7218S | 9/16 | 1-3/32 | 1-3/16 | 9/16 | 5/8 | 1-1/8 | 0.17 |



ASME B107.2

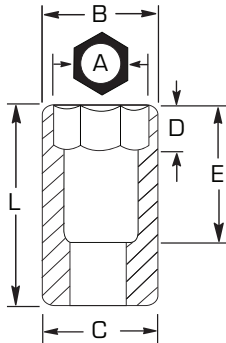

3/8" DRIVE IMPACT HEX BIT SOCKETS

| Product # | Size (in) | Bit Length (in) | Overall Length (in) | Weight (lbs) |
|-----------|-----------|-----------------|---------------------|--------------|
| J72901/8 | 1/8 | 1-5/8 | 2-23/32 | 0.07 |
| J72905/32 | 5/32 | 1-5/8 | 2-23/32 | 0.08 |
| J72903/16 | 3/16 | 1-5/8 | 2-23/32 | 0.08 |
| J72907/32 | 7/32 | 1-5/8 | 2-23/32 | 0.09 |
| J72901/4 | 1/4 | 1-5/8 | 2-23/32 | 0.10 |
| J72905/16 | 5/16 | 1-5/8 | 2-23/32 | 0.13 |
| J72903/8 | 3/8 | 1-5/8 | 2-23/32 | 0.14 |



3/8" DRIVE METRIC IMPACT HEX BIT SOCKETS

- ▶ Size stamped on tool for easy identification.
- ▶ Side locking hole.

| Product # | Size (mm) | Bit Length (in) | Overall Length (in) | Weight (lbs) |
|-----------|-----------|-----------------|---------------------|--------------|
| J7290-4M | 4 | 1-5/8 | 2-23/32 | 0.07 |
| J7290-5M | 5 | 1-5/8 | 2-23/32 | 0.08 |
| J7290-6M | 6 | 1-5/8 | 2-23/32 | 0.09 |
| J7290-8M | 8 | 1-5/8 | 2-23/32 | 0.12 |
| J7290-10M | 10 | 1-5/8 | 2-23/32 | 0.14 |



3/8" DRIVE TORX® IMPACT SOCKETS

- ▶ Made of heat-treated alloy steel.
- ▶ Socket size stamped on tool for easy identification.
- ▶ Side locking hole.
- ▶ For use with Torx® style fasteners.



| Product # | Torx® Size | Length (in) | Overall Length (in) | Weight (lbs) |
|----------------|------------|-------------|---------------------|--------------|
| J7206TX | E6 | 1-1/4 | 1-1/4 | 0.06 |
| J7207TX | E7 | 1-1/4 | 1-1/4 | 0.07 |
| J7208TX | E8 | 1-1/4 | 1-1/4 | 0.07 |
| J7210TX | E10 | 1-1/4 | 1-1/4 | 0.07 |
| J7212TX | E12 | 1-1/4 | 1-1/4 | 0.07 |
| J7214TX | E14 | 1-1/4 | 1-1/4 | 0.09 |
| J7216TX | E16 | 1-1/4 | 1-1/4 | 0.10 |



3/8" DRIVE IMPACT UNIVERSAL SOCKETS - 6 POINT

- ▶ Ball and spring design which allows for a 30° working angle.
- ▶ Smooth 360° rotation.
- ▶ Proto® 6 Point Impact Sockets are ideal for use on stubborn or damaged fasteners, and also on fasteners made from soft materials.
- ▶ TorquePlus™ features apply.
- ▶ Socket size stamped on tool for easy identification.
- ▶ Side locking hole.



| Product # | Size (in) | Nut End Outside Dia. (in) (B) | Drive End Outside Dia. (in) (C) | Nut Depth (in) (D) | Bolt Clearance Depth (in) (E) | Overall Length (in) (L) | Weight (lbs) |
|----------------|-----------|-------------------------------|---------------------------------|--------------------|-------------------------------|-------------------------|--------------|
| J77273P | 3/8 | 9/16 | 61/64 | 7/16 | 7/16 | 1-57/64 | 0.30 |
| J77274P | 7/16 | 21/32 | 61/64 | 7/16 | 7/16 | 1-63/64 | 0.31 |
| J77275P | 1/2 | 3/4 | 61/64 | 7/16 | 7/16 | 2-1/64 | 0.32 |
| J77276P | 9/16 | 13/16 | 61/64 | 7/16 | 7/16 | 2-1/64 | 0.33 |
| J77277P | 5/8 | 29/32 | 61/64 | 7/16 | 7/16 | 2-5/64 | 0.35 |
| J77278P | 11/16 | 1 | 61/64 | 7/16 | 7/16 | 2-7/64 | 0.29 |
| J77279P | 3/4 | 1-1/16 | 61/64 | 7/16 | 7/16 | 2-7/64 | 0.29 |



ASME B107.2

3/8" DRIVE METRIC IMPACT UNIVERSAL SOCKETS - 6 POINT

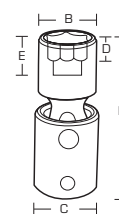

METRIC

| Product # | Drive End Outside Dia. | | Bolt Clearance Depth | | Overall Length (in) (L) | Weight (lbs) |
|-----------------|------------------------|----------|----------------------|----------|-------------------------|--------------|
| | Size (mm) | (in) (C) | Nut Depth (in) (D) | (in) (E) | | |
| J77408MP | 8 | 15/16 | 7/16 | 7/16 | 2 | 0.26 |
| J77410MP | 10 | 15/16 | 7/16 | 7/16 | 2 | 0.21 |
| J77411MP | 11 | 15/16 | 7/16 | 7/16 | 2 | 0.22 |
| J77412MP | 12 | 15/16 | 7/16 | 7/16 | 2-1/32 | 0.22 |
| J77413MP | 13 | 15/16 | 7/16 | 7/16 | 2-1/32 | 0.23 |
| J77414MP | 14 | 15/16 | 7/16 | 7/16 | 2-1/16 | 0.23 |
| J77415MP | 15 | 15/16 | 7/16 | 7/16 | 2-1/16 | 0.24 |
| J77416MP | 16 | 15/16 | 7/16 | 7/16 | 2-3/32 | 0.25 |
| J77417MP | 17 | 15/16 | 7/16 | 7/16 | 2-1/8 | 0.26 |
| J77418MP | 18 | 15/16 | 7/16 | 7/16 | 2-1/8 | 0.28 |
| J77419MP | 19 | 15/16 | 7/16 | 7/16 | 2-1/8 | 0.28 |



3/8" DRIVE METRIC DEEP UNIVERSAL IMPACT SOCKETS - 6 POINT



| Product # | Drive End Outside Dia. | | Bolt Clearance Depth | | Overall Length (in) (L) | Weight (lbs) |
|-----------|------------------------|----------|----------------------|----------|-------------------------|--------------|
| | Size (mm) | (in) (C) | Nut Depth (in) (D) | (in) (E) | | |
| J78410MP | 10 | 15/16 | 3/8 | 1 | 2 | 0.24 |
| J78411MP | 11 | 15/16 | 3/8 | 1 | 2 | 0.25 |
| J78412MP | 12 | 15/16 | 3/8 | 1 | 2-1/32 | 0.28 |
| J78413MP | 13 | 15/16 | 13/32 | 1-1/32 | 2-1/32 | 0.28 |
| J78414MP | 14 | 15/16 | 13/32 | 1-1/32 | 2-1/16 | 0.30 |
| J78415MP | 15 | 15/16 | 13/32 | 1-1/32 | 2-1/16 | 0.31 |
| J78416MP | 16 | 15/16 | 7/16 | 1-1/16 | 2-3/32 | 0.32 |
| J78417MP | 17 | 15/16 | 7/16 | 1-1/8 | 2-1/8 | 0.36 |
| J78418MP | 18 | 15/16 | 15/32 | 1-1/8 | 2-1/8 | 0.36 |
| J78419MP | 19 | 15/16 | 1/2 | 1-9/64 | 2-1/8 | 0.38 |



3/8" DRIVE METRIC UNIVERSAL IMPACT SOCKETS - 12 POINT



| Product # | Drive End Outside Dia. | | Bolt Clearance Depth | | Overall Length (in) (L) | Weight (lbs) |
|-----------|------------------------|----------|----------------------|----------|-------------------------|--------------|
| | Size (mm) | (in) (C) | Nut Depth (in) (D) | (in) (E) | | |
| J77510MP | 10 | 15/16 | 7/16 | 7/16 | 2 | 0.21 |
| J77511MP | 11 | 15/16 | 7/16 | 7/16 | 2 | 0.22 |
| J77512MP | 12 | 15/16 | 7/16 | 7/16 | 2-1/32 | 0.22 |
| J77513MP | 13 | 15/16 | 7/16 | 7/16 | 2-1/32 | 0.23 |
| J77514MP | 14 | 15/16 | 7/16 | 7/16 | 2-1/16 | 0.23 |
| J77515MP | 15 | 15/16 | 7/16 | 7/16 | 2-1/16 | 0.24 |
| J77516MP | 16 | 15/16 | 7/16 | 7/16 | 2-3/32 | 0.25 |
| J77517MP | 17 | 15/16 | 7/16 | 7/16 | 2-1/8 | 0.26 |
| J77518MP | 18 | 15/16 | 7/16 | 7/16 | 2-1/8 | 0.28 |
| J77519MP | 19 | 15/16 | 7/16 | 7/16 | 2-1/8 | 0.28 |



3/8" DRIVE IMPACT UNIVERSAL JOINT

- › Tight tolerances for snug fit on fastener.
- › Used wherever powered drive tools are used to install or remove fasteners.
- › Designed to withstand the high torque and force associated with impact tools in repetitive application.
- › Features two through holes and a groove to accept a Proto® Retaining Ring or pin and O-ring to help secure the socket to the drive tool anvil.
- › Position at appropriate angle to turn fasteners where obstructions prevent a straight application.
- › Ball and spring design which allows for a 30° working angle.
- › Smooth 360° rotation.

| Product # | Size (in) | Drive End | | Overall Length (in) (L) | Weight (lbs) |
|-----------|-----------|-----------------------|-------------|-------------------------|--------------|
| | | Outside Dia. (in) (C) | Length (in) | | |
| J77270P | 3/8 | 15/16 | 2-1/32 | 0.21 | |



3/8" DRIVE IMPACT ADAPTERS

| Product # | Size (in) | Overall Length (in) (L) | Weight (lbs) |
|-----------|-----------------|-------------------------|--------------|
| J7653 | 3/4" F x 1/2" M | 2-1/16 | 0.48 |
| J7650 | 3/8" F x 1/2" M | 1-5/16 | 0.13 |
| J7651 | 1/2" F x 3/8" M | 1-7/16 | 0.12 |



ASME B107.2

- › Use adapters to help increase or decrease drive end size.
- › Do not use hand adapters with power tools.
- › Do not overtorque small sockets when using them with adapters on large drive tools.
- › Size stamped on tool for easy identification.
- › Side locking hole.



3/8" DRIVE IMPACT EXTENSIONS

- › Use extensions to gain access to fasteners in locations that would otherwise be difficult to reach.
- › Male square is oriented in line with female squares for use with fixed head torque wrenches.
- › Full chamfer at drive opening (when applicable) for easy engagement with drive tools.
- › Drive end chamfer and four detents help provide quick positive engagement with drive tool on any of the socket drive walls.
- › Size stamped on tool for easy identification.
- › Side locking hole.

| Product # | Overall Length (in) (L) | Weight (lbs) |
|---------------|-------------------------|--------------|
| J7175P | 3 | 0.16 |
| J7176P | 6 | 0.32 |
| J7178P | 12 | 0.64 |

ASME B107.2



3/8" DRIVE IMPACT LOCKING EXTENSIONS

- › Black oxide finish.
- › Easy operating spring-loaded locking mechanism.

| Product # | Overall Length (in) (L) | Weight (lbs) |
|---------------|-------------------------|--------------|
| J7203L | 3 | 0.25 |
| J7206L | 6 | 0.41 |
| J7212L | 12 | 0.75 |

ASME B107.2



3/8" DRIVE HAND IMPACT DRIVER

- › Designed to loosen hard to turn bolts and screws.
- › Heavy-duty spring for added torque.

| Product # | Overall Length (in) (L) | Weight (lbs) |
|--------------|-------------------------|--------------|
| J7099 | 5-1/2 | 1.68 |

ASME B107.2



3/8" DRIVE RETAINING RINGS

- › Proto® 3/8" Drive Retaining Rings have a one-piece, without a crush gauge.



| Product # | Description | For Groove Dia. (in) | Diameter (in) | Height (in) | Weight (lbs) |
|-----------------|----------------------------------|----------------------|---------------|-------------|--------------|
| JRR37560 | Retaining Ring, 3/8" DR 600 GRV | 19/32 | 11/16 | 1/16 | 0.01 |
| JRR37567 | Retaining Ring, 3/8" DR 670 GRV | 43/64 | 3/4 | 1/16 | 0.01 |
| JRR37575 | Retaining Ring, 3/8" DR 750 GRV | 3/4 | 13/16 | 1/16 | 0.01 |
| JRR37582 | Retaining Ring, 3/8" DR 820 GRV | 13/64 | 7/8 | 1/16 | 0.01 |
| JRR37595 | Retaining Ring, 3/8" DR 950 GRV | 61/64 | 1 | 1/16 | 0.01 |
| JRR37511 | Retaining Ring, 3/8" DR 1100 GRV | 1-3/32" | 1-3/16 | 1/16 | 0.01 |
| JRR37512 | Retaining Ring, 3/8" DR 1200 GRV | 1-3/16" | 1-1/4 | 1/16 | 0.01 |

ASME B107.2

1/2" DRIVE 25 PIECE METRIC IMPACT SOCKET SET - 6 POINT

METRIC

Product #: J74206



- › Proto® 6 Point Impact Sockets are ideal for use on stubborn or damaged fasteners, and also on fasteners made from soft materials.
- › TorquePlus™ features apply.
- › Weight (lbs): 10.28



| Contents | Description | ASME Spec. |
|----------|-----------------------------------|---------------|
| J7408M | Socket, Impact 1/2" DR 8 mm 6 PT | ASME B107.33M |
| J7409M | Socket, Impact 1/2" DR 9 mm 6 PT | ASME B107.33M |
| J7410M | Socket, Impact 1/2" DR 10 mm 6 PT | ASME B107.33M |
| J7411M | Socket, Impact 1/2" DR 11 mm 6 PT | ASME B107.33M |
| J7412M | Socket, Impact 1/2" DR 12 mm 6 PT | ASME B107.33M |
| J7413M | Socket, Impact 1/2" DR 13 mm 6 PT | ASME B107.33M |
| J7414M | Socket, Impact 1/2" DR 14 mm 6 PT | ASME B107.33M |
| J7415M | Socket, Impact 1/2" DR 15 mm 6 PT | ASME B107.33M |
| J7416M | Socket, Impact 1/2" DR 16 mm 6 PT | ASME B107.33M |
| J7417M | Socket, Impact 1/2" DR 17 mm 6 PT | ASME B107.33M |
| J7418M | Socket, Impact 1/2" DR 18 mm 6 PT | ASME B107.33M |
| J7419M | Socket, Impact 1/2" DR 19 mm 6 PT | ASME B107.33M |
| J7420M | Socket, Impact 1/2" DR 20 mm 6 PT | ASME B107.33M |
| J7421M | Socket, Impact 1/2" DR 21 mm 6 PT | ASME B107.33M |
| J7422M | Socket, Impact 1/2" DR 22 mm 6 PT | ASME B107.33M |
| J7423M | Socket, Impact 1/2" DR 23 mm 6 PT | ASME B107.33M |
| J7424M | Socket, Impact 1/2" DR 24 mm 6 PT | ASME B107.33M |
| J7425M | Socket, Impact 1/2" DR 25 mm 6 PT | ASME B107.33M |
| J7426M | Socket, Impact 1/2" DR 26 mm 6 PT | ASME B107.33M |
| J7427M | Socket, Impact 1/2" DR 27 mm 6 PT | ASME B107.33M |
| J7428M | Socket, Impact 1/2" DR 28 mm 6 PT | ASME B107.33M |
| J7429M | Socket, Impact 1/2" DR 29 mm 6 PT | ASME B107.33M |
| J7430M | Socket, Impact 1/2" DR 30 mm 6 PT | ASME B107.33M |
| J7432M | Socket, Impact 1/2" DR 32 mm 6 PT | ASME B107.33M |
| J7436M | Socket, Impact 1/2" DR 36 mm 6 PT | ASME B107.33M |
| J2587 | Socket, Bar 17" | |
| J2592 | Socket, Clip 1/2" DR | |



1/2" DRIVE 25 PIECE METRIC DEEP IMPACT SOCKET SET - 6 POINT

Product #: J74216



- ▶ Proto® 6 Point Impact Sockets are ideal for use on stubborn or damaged fasteners, and also on fasteners made from soft materials.
- ▶ TorquePlus™ features apply.
- ▶ Weight (lbs): 19.63



| Contents | Description | ASME Spec. |
|----------|--|---------------|
| J7308M | Socket, Impact 1/2" DR 8 mm 6 PT Deep | ASME B107.33M |
| J7309M | Socket, Impact 1/2" DR 9 mm 6 PT Deep | ASME B107.33M |
| J7310M | Socket, Impact 1/2" DR 10 mm 6 PT Deep | ASME B107.33M |
| J7311M | Socket, Impact 1/2" DR 11 mm 6 PT Deep | ASME B107.33M |
| J7312M | Socket, Impact 1/2" DR 12 mm 6 PT Deep | ASME B107.33M |
| J7313M | Socket, Impact 1/2" DR 13 mm 6 PT Deep | ASME B107.33M |
| J7314M | Socket, Impact 1/2" DR 14 mm 6 PT Deep | ASME B107.33M |
| J7315M | Socket, Impact 1/2" DR 15 mm 6 PT Deep | ASME B107.33M |
| J7316M | Socket, Impact 1/2" DR 16 mm 6 PT Deep | ASME B107.33M |
| J7317M | Socket, Impact 1/2" DR 17 mm 6 PT Deep | ASME B107.33M |
| J7318M | Socket, Impact 1/2" DR 18 mm 6 PT Deep | ASME B107.33M |
| J7319M | Socket, Impact 1/2" DR 19 mm 6 PT Deep | ASME B107.33M |
| J7320M | Socket, Impact 1/2" DR 20 mm 6 PT Deep | ASME B107.33M |
| J7321M | Socket, Impact 1/2" DR 21 mm 6 PT Deep | ASME B107.33M |
| J7322M | Socket, Impact 1/2" DR 22 mm 6 PT Deep | ASME B107.33M |
| J7323M | Socket, Impact 1/2" DR 23 mm 6 PT Deep | ASME B107.33M |
| J7324M | Socket, Impact 1/2" DR 24 mm 6 PT Deep | ASME B107.33M |
| J7325M | Socket, Impact 1/2" DR 25 mm 6 PT Deep | ASME B107.33M |
| J7326M | Socket, Impact 1/2" DR 26 mm 6 PT Deep | ASME B107.33M |
| J7327M | Socket, Impact 1/2" DR 27 mm 6 PT Deep | ASME B107.33M |
| J7328M | Socket, Impact 1/2" DR 28 mm 6 PT Deep | ASME B107.33M |
| J7329M | Socket, Impact 1/2" DR 29 mm 6 PT Deep | ASME B107.33M |
| J7330M | Socket, Impact 1/2" DR 30 mm 6 PT Deep | ASME B107.33M |
| J7332M | Socket, Impact 1/2" DR 32 mm 6 PT Deep | ASME B107.33M |
| J7336M | Socket, Impact 1/2" DR 36 mm 6 PT Deep | ASME B107.33M |
| J2587 | Socket, Bar 17" | |
| J2592 | Socket, Clip 1/2" DR | |





1/2" DRIVE 19 PIECE IMPACT SOCKET SET - 6 POINT

Product #: **J74106**



| Contents | Description | ASME Spec. |
|----------|-------------------------------------|-------------|
| J7412H | Socket, Impact 1/2" DR 3/8" 6 PT | ASME B107.2 |
| J7414H | Socket, Impact 1/2" DR 7/16" 6 PT | ASME B107.2 |
| J7416H | Socket, Impact 1/2" DR 1/2" 6 PT | ASME B107.2 |
| J7418H | Socket, Impact 1/2" DR 9/16" 6 PT | ASME B107.2 |
| J7420H | Socket, Impact 1/2" DR 5/8" 6 PT | ASME B107.2 |
| J7422H | Socket, Impact 1/2" DR 11/16" 6 PT | ASME B107.2 |
| J7424H | Socket, Impact 1/2" DR 3/4" 6 PT | ASME B107.2 |
| J7426H | Socket, Impact 1/2" DR 13/16" 6 PT | ASME B107.2 |
| J7428H | Socket, Impact 1/2" DR 7/8" 6 PT | ASME B107.2 |
| J7430H | Socket, Impact 1/2" DR 15/16" 6 PT | ASME B107.2 |
| J7432H | Socket, Impact 1/2" DR 1" 6 PT | ASME B107.2 |
| J7434H | Socket, Impact 1/2" DR 1-1/16" 6 PT | ASME B107.2 |
| J7436H | Socket, Impact 1/2" DR 1-1/8" 6 PT | ASME B107.2 |
| J7438H | Socket, Impact 1/2" DR 1-3/16" 6 PT | ASME B107.2 |
| J7440H | Socket, Impact 1/2" DR 1-1/4" 6 PT | ASME B107.2 |
| J7442H | Socket, Impact 1/2" DR 1-5/16" 6 PT | ASME B107.2 |
| J7444H | Socket, Impact 1/2" DR 1-3/8" 6 PT | ASME B107.2 |
| J7446H | Socket, Impact 1/2" DR 1-7/16" 6 PT | ASME B107.2 |
| J7448H | Socket, Impact 1/2" DR 1-1/2" 6 PT | ASME B107.2 |
| J2587 | Socket, Bar 17" | |
| J2592 | Socket, Clip 1/2" DR | |
| J2585 | Socket, Bar 9" | |

- › Proto® 6 Point Impact Sockets are ideal for use on stubborn or damaged fasteners, and also on fasteners made from soft materials.
- › TorquePlus™ features apply.
- › Weight (lbs): 10.06



1/2" DRIVE 19 PIECE DEEP IMPACT SOCKET SET - 6 POINT

Product #: **J74116**



- › Proto® 6 Point Impact Sockets are ideal for use on stubborn or damaged fasteners, and also on fasteners made from soft materials.
- › TorquePlus™ features apply.
- › Weight (lbs): 18.72



| Contents | Description | ASME Spec. |
|----------|--|-------------|
| J7312H | Socket, Impact 1/2" DR 3/8" 6 PT Deep | ASME B107.2 |
| J7314H | Socket, Impact 1/2" DR 7/16" 6 PT Deep | ASME B107.2 |
| J7316H | Socket, Impact 1/2" DR 1/2" 6 PT Deep | ASME B107.2 |
| J7318H | Socket, Impact 1/2" DR 9/16" 6 PT Deep | ASME B107.2 |
| J7320H | Socket, Impact 1/2" DR 5/8" 6 PT Deep | ASME B107.2 |
| J7322H | Socket, Impact 1/2" DR 11/16" 6 PT Deep | ASME B107.2 |
| J7324H | Socket, Impact 1/2" DR 3/4" 6 PT Deep | ASME B107.2 |
| J7326H | Socket, Impact 1/2" DR 13/16" 6 PT Deep | ASME B107.2 |
| J7328H | Socket, Impact 1/2" DR 7/8" 6 PT Deep | ASME B107.2 |
| J7330H | Socket, Impact 1/2" DR 15/16" 6 PT Deep | ASME B107.2 |
| J7332H | Socket, Impact 1/2" DR 1" 6 PT Deep | ASME B107.2 |
| J7334H | Socket, Impact 1/2" DR 1-1/16" 6 PT Deep | ASME B107.2 |
| J7336H | Socket, Impact 1/2" DR 1-1/8" 6 PT Deep | ASME B107.2 |
| J7338H | Socket, Impact 1/2" DR 1-3/16" 6 PT Deep | ASME B107.2 |
| J7340H | Socket, Impact 1/2" DR 1-1/4" 6 PT Deep | ASME B107.2 |
| J7342H | Socket, Impact 1/2" DR 1-5/16" 6 PT Deep | ASME B107.2 |
| J7344H | Socket, Impact 1/2" DR 1-3/8" 6 PT Deep | ASME B107.2 |
| J7346H | Socket, Impact 1/2" DR 1-7/16" 6 PT Deep | ASME B107.2 |
| J7348H | Socket, Impact 1/2" DR 1-1/2" 6 PT Deep | ASME B107.2 |
| J2585 | Socket, Bar 9" | |
| J2587 | Socket, Bar 17" | |
| J2592 | Socket, Clip 1/2" DR | |



1/2" DRIVE 18 PIECE METRIC DEEP IMPACT SOCKET SET - 6 POINT

Product #: **J72149M**

- ▶ Deep Sockets: 10, 11, 12, 13, 14, 15, 16, 17, 18, 19, 20, 21, 22, 23, 24, 25, 26, 27 mm.
- ▶ Accessories: Socket Clip and Socket Rails.
- ▶ Weight (lbs): 9.32



| Contents | Description | ASME Spec. |
|----------|--|---------------|
| J7310M | Socket, Impact 1/2" DR 10 mm 6 PT Deep | ASME B107.33M |
| J7311M | Socket, Impact 1/2" DR 11 mm 6 PT Deep | ASME B107.33M |
| J7312M | Socket, Impact 1/2" DR 12 mm 6 PT Deep | ASME B107.33M |
| J7313M | Socket, Impact 1/2" DR 13 mm 6 PT Deep | ASME B107.33M |
| J7314M | Socket, Impact 1/2" DR 14 mm 6 PT Deep | ASME B107.33M |
| J7315M | Socket, Impact 1/2" DR 15 mm 6 PT Deep | ASME B107.33M |
| J7316M | Socket, Impact 1/2" DR 16 mm 6 PT Deep | ASME B107.33M |
| J7317M | Socket, Impact 1/2" DR 17 mm 6 PT Deep | ASME B107.33M |
| J7318M | Socket, Impact 1/2" DR 18 mm 6 PT Deep | ASME B107.33M |
| J7319M | Socket, Impact 1/2" DR 19 mm 6 PT Deep | ASME B107.33M |
| J7320M | Socket, Impact 1/2" DR 20 mm 6 PT Deep | ASME B107.33M |
| J7321M | Socket, Impact 1/2" DR 21 mm 6 PT Deep | ASME B107.33M |
| J7322M | Socket, Impact 1/2" DR 22 mm 6 PT Deep | ASME B107.33M |
| J7323M | Socket, Impact 1/2" DR 23 mm 6 PT Deep | ASME B107.33M |
| J7324M | Socket, Impact 1/2" DR 24 mm 6 PT Deep | ASME B107.33M |
| J7325M | Socket, Impact 1/2" DR 25 mm 6 PT Deep | ASME B107.33M |
| J7326M | Socket, Impact 1/2" DR 26 mm 6 PT Deep | ASME B107.33M |
| J7327M | Socket, Impact 1/2" DR 27 mm 6 PT Deep | ASME B107.33M |
| J2585 | Socket, Bar 9" | |
| J2587 | Socket, Bar 17" | |
| J2592 | Socket, Clip 1/2" DR | |

1/2" DRIVE 15 PIECE IMPACT SOCKET SET - 6 POINT

Product #: **J74104**

| Contents | Description | ASME Spec. |
|----------|-------------------------------------|-------------|
| J7412H | Socket, Impact 1/2" DR 3/8" 6 PT | ASME B107.2 |
| J7414H | Socket, Impact 1/2" DR 7/16" 6 PT | ASME B107.2 |
| J7416H | Socket, Impact 1/2" DR 1/2" 6 PT | ASME B107.2 |
| J7418H | Socket, Impact 1/2" DR 9/16" 6 PT | ASME B107.2 |
| J7420H | Socket, Impact 1/2" DR 5/8" 6 PT | ASME B107.2 |
| J7422H | Socket, Impact 1/2" DR 11/16" 6 PT | ASME B107.2 |
| J7424H | Socket, Impact 1/2" DR 3/4" 6 PT | ASME B107.2 |
| J7426H | Socket, Impact 1/2" DR 13/16" 6 PT | ASME B107.2 |
| J7428H | Socket, Impact 1/2" DR 7/8" 6 PT | ASME B107.2 |
| J7430H | Socket, Impact 1/2" DR 15/16" 6 PT | ASME B107.2 |
| J7432H | Socket, Impact 1/2" DR 1" 6 PT | ASME B107.2 |
| J7434H | Socket, Impact 1/2" DR 1-1/16" 6 PT | ASME B107.2 |
| J7436H | Socket, Impact 1/2" DR 1-1/8" 6 PT | ASME B107.2 |
| J7438H | Socket, Impact 1/2" DR 1-3/16" 6 PT | ASME B107.2 |
| J7440H | Socket, Impact 1/2" DR 1-1/4" 6 PT | ASME B107.2 |
| J2584 | Socket, Bar 6-1/4" | |
| J2587 | Socket, Bar 17" | |
| J2592 | Socket, Clip 1/2" DR | |

- ▶ Proto® 6 Point Impact Sockets are ideal for use on stubborn or damaged fasteners, and also on fasteners made from soft materials.
- ▶ TorquePlus™ features apply.
- ▶ Weight (lbs): 6.44



1/2" DRIVE 15 PIECE IMPACT METRIC THIN WALL SOCKET SET - 6 POINT



Product #: **J74217**



- › Proto® 6 Point Impact Sockets are ideal for use on stubborn or damaged fasteners, and also on fasteners made from soft materials.
- › TorquePlus™ features apply.
- › Weight (lbs): 7.51



| Contents | Description | ASME Spec. |
|----------|--|---------------|
| J7310MHT | Socket, Impact Thin Wall 1/2" DR 10 mm 6 PT Deep | ASME B107.33M |
| J7311MHT | Socket, Impact Thin Wall 1/2" DR 11 mm 6 PT Deep | ASME B107.33M |
| J7312MHT | Socket, Impact Thin Wall 1/2" DR 12 mm 6 PT Deep | ASME B107.33M |
| J7313MHT | Socket, Impact Thin Wall 1/2" DR 13 mm 6 PT Deep | ASME B107.33M |
| J7314MHT | Socket, Impact Thin Wall 1/2" DR 14 mm 6 PT Deep | ASME B107.33M |
| J7315MHT | Socket, Impact Thin Wall 1/2" DR 15 mm 6 PT Deep | ASME B107.33M |
| J7316MHT | Socket, Impact Thin Wall 1/2" DR 16 mm 6 PT Deep | ASME B107.33M |
| J7317MHT | Socket, Impact Thin Wall 1/2" DR 17 mm 6 PT Deep | ASME B107.33M |
| J7318MHT | Socket, Impact Thin Wall 1/2" DR 18 mm 6 PT Deep | ASME B107.33M |
| J7319MHT | Socket, Impact Thin Wall 1/2" DR 19 mm 6 PT Deep | ASME B107.33M |
| J7320MHT | Socket, Impact Thin Wall 1/2" DR 20 mm 6 PT Deep | ASME B107.33M |
| J7321MHT | Socket, Impact Thin Wall 1/2" DR 21 mm 6 PT Deep | ASME B107.33M |
| J7322MHT | Socket, Impact Thin Wall 1/2" DR 22 mm 6 PT Deep | ASME B107.33M |
| J7323MHT | Socket, Impact Thin Wall 1/2" DR 23 mm 6 PT Deep | ASME B107.33M |
| J7324MHT | Socket, Impact Thin Wall 1/2" DR 24 mm 6 PT Deep | ASME B107.33M |
| J2587 | Socket, Bar 17" | |
| J2592 | Socket, Clip 1/2" DR | |

1/2" DRIVE 15 PIECE METRIC DEEP IMPACT SOCKET SET - 6 POINT

Product #: **J74214**



- › Proto® 6 Point Impact Sockets are ideal for use on stubborn or damaged fasteners, and also on fasteners made from soft materials.
- › TorquePlus™ features apply.
- › Weight (lbs): 8.61



| Contents | Description | ASME Spec. |
|----------|--|---------------|
| J7310M | Socket, Impact 1/2" DR 10 mm 6 PT Deep | ASME B107.33M |
| J7311M | Socket, Impact 1/2" DR 11 mm 6 PT Deep | ASME B107.33M |
| J7312M | Socket, Impact 1/2" DR 12 mm 6 PT Deep | ASME B107.33M |
| J7313M | Socket, Impact 1/2" DR 13 mm 6 PT Deep | ASME B107.33M |
| J7314M | Socket, Impact 1/2" DR 14 mm 6 PT Deep | ASME B107.33M |
| J7315M | Socket, Impact 1/2" DR 15 mm 6 PT Deep | ASME B107.33M |
| J7316M | Socket, Impact 1/2" DR 16 mm 6 PT Deep | ASME B107.33M |
| J7317M | Socket, Impact 1/2" DR 17 mm 6 PT Deep | ASME B107.33M |
| J7318M | Socket, Impact 1/2" DR 18 mm 6 PT Deep | ASME B107.33M |
| J7319M | Socket, Impact 1/2" DR 19 mm 6 PT Deep | ASME B107.33M |
| J7320M | Socket, Impact 1/2" DR 20 mm 6 PT Deep | ASME B107.33M |
| J7321M | Socket, Impact 1/2" DR 21 mm 6 PT Deep | ASME B107.33M |
| J7322M | Socket, Impact 1/2" DR 22 mm 6 PT Deep | ASME B107.33M |
| J7323M | Socket, Impact 1/2" DR 23 mm 6 PT Deep | ASME B107.33M |
| J7324M | Socket, Impact 1/2" DR 24 mm 6 PT Deep | ASME B107.33M |
| J2587 | Socket, Bar 17" | |
| J2592 | Socket, Clip 1/2" DR | |



1/2" DRIVE 15 PIECE DEEP IMPACT SOCKET SET - 6 POINT

Product #: J74114

- ▶ Proto® 6 Point Impact Sockets are ideal for use on stubborn or damaged fasteners, and also on fasteners made from soft materials.
- ▶ TorquePlus™ features apply.
- ▶ Weight (lbs): 11.91



| Contents | Description | ASME Spec. |
|----------|--|-------------|
| J7312H | Socket, Impact 1/2" DR 3/8" 6 PT Deep | ASME B107.2 |
| J7314H | Socket, Impact 1/2" DR 7/16" 6 PT Deep | ASME B107.2 |
| J7316H | Socket, Impact 1/2" DR 1/2" 6 PT Deep | ASME B107.2 |
| J7318H | Socket, Impact 1/2" DR 9/16" 6 PT Deep | ASME B107.2 |
| J7320H | Socket, Impact 1/2" DR 5/8" 6 PT Deep | ASME B107.2 |
| J7322H | Socket, Impact 1/2" DR 11/16" 6 PT Deep | ASME B107.2 |
| J7324H | Socket, Impact 1/2" DR 3/4" 6 PT Deep | ASME B107.2 |
| J7326H | Socket, Impact 1/2" DR 13/16" 6 PT Deep | ASME B107.2 |
| J7328H | Socket, Impact 1/2" DR 7/8" 6 PT Deep | ASME B107.2 |
| J7330H | Socket, Impact 1/2" DR 15/16" 6 PT Deep | ASME B107.2 |
| J7332H | Socket, Impact 1/2" DR 1" 6 PT Deep | ASME B107.2 |
| J7334H | Socket, Impact 1/2" DR 1-1/16" 6 PT Deep | ASME B107.2 |
| J7336H | Socket, Impact 1/2" DR 1-1/8" 6 PT Deep | ASME B107.2 |
| J7338H | Socket, Impact 1/2" DR 1-3/16" 6 PT Deep | ASME B107.2 |
| J7340H | Socket, Impact 1/2" DR 1-1/4" 6 PT Deep | ASME B107.2 |
| J2584 | Socket, Bar 6-1/4" | |
| J2587 | Socket, Bar 17" | |
| J2592 | Socket, Clip 1/2" DR | |

1/2" DRIVE 15 PIECE DEEP THIN WALL IMPACT SOCKET SET - 6 POINT

Product #: J74117

- ▶ Specifically designed for light clearance applications.
- ▶ Reduced wall thickness helps improve access to fasteners in restricted areas.
- ▶ All Impact sockets feature one through hole and a groove to accept a retaining ring and pin to secure the socket to the power tool anvil. Chamfered service ends for quick and positive fastener engagement.
- ▶ Proto® 6 Point Impact Sockets are ideal for use on stubborn or damaged fasteners, and also on fasteners made from soft materials.
- ▶ Thinner walls help improve productivity by making it easier to gain access to fasteners in confined spaces.
- ▶ Often used in application where fasteners are close together, such as tire service.
- ▶ Extra deep length helps improve access in confined areas.
- ▶ TorquePlus™ features apply.
- ▶ Thin wall sockets are lightweight.
- ▶ Designed to fit into smaller spaces.
- ▶ Weight (lbs): 10.06



| Contents | Description | ASME Spec. |
|----------|--|-------------|
| J7312HT | Socket, Impact Thin Wall 1/2" DR 3/8" 6 PT Deep | ASME B107.2 |
| J7314HT | Socket, Impact Thin Wall 1/2" DR 7/16" 6 PT Deep | ASME B107.2 |
| J7316HT | Socket, Impact Thin Wall 1/2" DR 1/2" 6 PT Deep | ASME B107.2 |
| J7318HT | Socket, Impact Thin Wall 1/2" DR 9/16" 6 PT Deep | ASME B107.2 |
| J7320HT | Socket, Impact Thin Wall 1/2" DR 5/8" 6 PT Deep | ASME B107.2 |
| J7322HT | Socket, Impact Thin Wall 1/2" DR 11/16" 6 PT Deep | ASME B107.2 |
| J7324HT | Socket, Impact Thin Wall 1/2" DR 3/4" 6 PT Deep | ASME B107.2 |
| J7326HT | Socket, Impact Thin Wall 1/2" DR 13/16" 6 PT Deep | ASME B107.2 |
| J7328HT | Socket, Impact Thin Wall 1/2" DR 7/8" 6 PT Deep | ASME B107.2 |
| J7330HT | Socket, Impact Thin Wall 1/2" DR 15/16" 6 PT Deep | ASME B107.2 |
| J7332HT | Socket, Impact Thin Wall 1/2" DR 1" 6 PT Deep | ASME B107.2 |
| J7334HT | Socket, Impact Thin Wall 1/2" DR 1-1/16" 6 PT Deep | ASME B107.2 |
| J7336HT | Socket, Impact Thin Wall 1/2" DR 1-1/8" 6 PT Deep | ASME B107.2 |
| J7338HT | Socket, Impact Thin Wall 1/2" DR 1-3/16" 6 PT Deep | ASME B107.2 |
| J7340HT | Socket, Impact Thin Wall 1/2" DR 1-1/4" 6 PT Deep | ASME B107.2 |

1/2" DRIVE 15 PIECE METRIC IMPACT SOCKET SET - 6 POINT

METRIC

Product #: J74204



- › Proto® 6 Point Impact Sockets are ideal for use on stubborn or damaged fasteners, and also on fasteners made from soft materials.
- › TorquePlus™ features apply.
- › Weight (lbs): 4.28



| Contents | Description | ASME Spec. |
|----------|-----------------------------------|---------------|
| J7410M | Socket, Impact 1/2" DR 10 mm 6 PT | ASME B107.33M |
| J7411M | Socket, Impact 1/2" DR 11 mm 6 PT | ASME B107.33M |
| J7412M | Socket, Impact 1/2" DR 12 mm 6 PT | ASME B107.33M |
| J7413M | Socket, Impact 1/2" DR 13 mm 6 PT | ASME B107.33M |
| J7414M | Socket, Impact 1/2" DR 14 mm 6 PT | ASME B107.33M |
| J7415M | Socket, Impact 1/2" DR 15 mm 6 PT | ASME B107.33M |
| J7416M | Socket, Impact 1/2" DR 16 mm 6 PT | ASME B107.33M |
| J7417M | Socket, Impact 1/2" DR 17 mm 6 PT | ASME B107.33M |
| J7418M | Socket, Impact 1/2" DR 18 mm 6 PT | ASME B107.33M |
| J7419M | Socket, Impact 1/2" DR 19 mm 6 PT | ASME B107.33M |
| J7420M | Socket, Impact 1/2" DR 20 mm 6 PT | ASME B107.33M |
| J7421M | Socket, Impact 1/2" DR 21 mm 6 PT | ASME B107.33M |
| J7422M | Socket, Impact 1/2" DR 22 mm 6 PT | ASME B107.33M |
| J7423M | Socket, Impact 1/2" DR 23 mm 6 PT | ASME B107.33M |
| J7424M | Socket, Impact 1/2" DR 24 mm 6 PT | ASME B107.33M |
| J2587 | Socket, Bar 17" | |
| J2592 | Socket, Clip 1/2" DR | |

1/2" DRIVE 11 PIECE IMPACT SOCKET SET - 6 POINT

Product #: J74102



| Contents | Description | ASME Spec. |
|----------|-------------------------------------|-------------|
| J7416H | Socket, Impact 1/2" DR 1/2" 6 PT | ASME B107.2 |
| J7418H | Socket, Impact 1/2" DR 9/16" 6 PT | ASME B107.2 |
| J7420H | Socket, Impact 1/2" DR 5/8" 6 PT | ASME B107.2 |
| J7422H | Socket, Impact 1/2" DR 11/16" 6 PT | ASME B107.2 |
| J7424H | Socket, Impact 1/2" DR 3/4" 6 PT | ASME B107.2 |
| J7426H | Socket, Impact 1/2" DR 13/16" 6 PT | ASME B107.2 |
| J7428H | Socket, Impact 1/2" DR 7/8" 6 PT | ASME B107.2 |
| J7430H | Socket, Impact 1/2" DR 15/16" 6 PT | ASME B107.2 |
| J7432H | Socket, Impact 1/2" DR 1" 6 PT | ASME B107.2 |
| J7434H | Socket, Impact 1/2" DR 1-1/16" 6 PT | ASME B107.2 |
| J7436H | Socket, Impact 1/2" DR 1-1/8" 6 PT | ASME B107.2 |
| J2586 | Socket, Bar 13" | |
| J2592 | Socket, Clip 1/2" DR | |

- › Proto® 6 Point Impact Sockets are ideal for use on stubborn or damaged fasteners, and also on fasteners made from soft materials.
- › TorquePlus™ features apply.
- › Weight (lbs): 4.10



1/2" DRIVE 11 PIECE DEEP IMPACT SOCKET SET - 6 POINT

Product #: J74112



- › Proto® 6 Point Impact Sockets are ideal for use on stubborn or damaged fasteners, and also on fasteners made from soft materials.
- › TorquePlus™ features apply.
- › Weight (lbs): 8.03



| Contents | Description | ASME Spec. |
|----------|--|-------------|
| J7316H | Socket, Impact 1/2" DR 1/2" 6 PT Deep | ASME B107.2 |
| J7318H | Socket, Impact 1/2" DR 9/16" 6 PT Deep | ASME B107.2 |



| Contents | Description | ASME Spec. |
|----------|--|-------------|
| J7320H | Socket, Impact 1/2" DR 5/8" 6 PT Deep | ASME B107.2 |
| J7322H | Socket, Impact 1/2" DR 11/16" 6 PT Deep | ASME B107.2 |
| J7324H | Socket, Impact 1/2" DR 3/4" 6 PT Deep | ASME B107.2 |
| J7326H | Socket, Impact 1/2" DR 13/16" 6 PT Deep | ASME B107.2 |
| J7328H | Socket, Impact 1/2" DR 7/8" 6 PT Deep | ASME B107.2 |
| J7330H | Socket, Impact 1/2" DR 15/16" 6 PT Deep | ASME B107.2 |
| J7332H | Socket, Impact 1/2" DR 1" 6 PT Deep | ASME B107.2 |
| J7334H | Socket, Impact 1/2" DR 1-1/16" 6 PT Deep | ASME B107.2 |
| J7336H | Socket, Impact 1/2" DR 1-1/8" 6 PT Deep | ASME B107.2 |
| J2586 | Socket, Bar 13" | |
| J2592 | Socket, Clip 1/2" DR | |

1/2" DRIVE 10 PIECE METRIC IMPACT SOCKET SET - 6 POINT METRIC

Product #: J74202

- ▶ Proto® 6 Point Impact Sockets are ideal for use on stubborn or damaged fasteners, and also on fasteners made from soft materials.
- ▶ TorquePlus™ features apply.
- ▶ Weight (lbs): 2.15



| Contents | Description | ASME Spec. |
|----------|-----------------------------------|---------------|
| J7410M | Socket, Impact 1/2" DR 10 mm 6 PT | ASME B107.33M |
| J7411M | Socket, Impact 1/2" DR 11 mm 6 PT | ASME B107.33M |
| J7412M | Socket, Impact 1/2" DR 12 mm 6 PT | ASME B107.33M |
| J7413M | Socket, Impact 1/2" DR 13 mm 6 PT | ASME B107.33M |
| J7414M | Socket, Impact 1/2" DR 14 mm 6 PT | ASME B107.33M |
| J7415M | Socket, Impact 1/2" DR 15 mm 6 PT | ASME B107.33M |
| J7416M | Socket, Impact 1/2" DR 16 mm 6 PT | ASME B107.33M |
| J7417M | Socket, Impact 1/2" DR 17 mm 6 PT | ASME B107.33M |
| J7418M | Socket, Impact 1/2" DR 18 mm 6 PT | ASME B107.33M |
| J7419M | Socket, Impact 1/2" DR 19 mm 6 PT | ASME B107.33M |
| J2586 | Socket, Bar 13" | |
| J2592 | Socket, Clip 1/2" DR | |

1/2" DRIVE 10 PIECE METRIC DEEP IMPACT SOCKET SET - 6 POINT

Product #: J74212

- ▶ Proto® 6 Point Impact Sockets are ideal for use on stubborn or damaged fasteners, and also on fasteners made from soft materials.
- ▶ TorquePlus™ features apply.
- ▶ Weight (lbs): 4.78



| Contents | Description | ASME Spec. |
|----------|--|---------------|
| J7310M | Socket, Impact 1/2" DR 10 mm 6 PT Deep | ASME B107.33M |
| J7311M | Socket, Impact 1/2" DR 11 mm 6 PT Deep | ASME B107.33M |
| J7312M | Socket, Impact 1/2" DR 12 mm 6 PT Deep | ASME B107.33M |
| J7313M | Socket, Impact 1/2" DR 13 mm 6 PT Deep | ASME B107.33M |
| J7314M | Socket, Impact 1/2" DR 14 mm 6 PT Deep | ASME B107.33M |
| J7315M | Socket, Impact 1/2" DR 15 mm 6 PT Deep | ASME B107.33M |
| J7316M | Socket, Impact 1/2" DR 16 mm 6 PT Deep | ASME B107.33M |
| J7317M | Socket, Impact 1/2" DR 17 mm 6 PT Deep | ASME B107.33M |
| J7318M | Socket, Impact 1/2" DR 18 mm 6 PT Deep | ASME B107.33M |
| J7319M | Socket, Impact 1/2" DR 19 mm 6 PT Deep | ASME B107.33M |
| J2587 | Socket, Bar 17" | |
| J2592 | Socket, Clip 1/2" DR | |

1/2" DRIVE 8 PIECE DEEP IMPACT SOCKET SET - 6 POINT

Product #: **J72159**



| Contents | Description | ASME Spec. |
|----------|---|-------------|
| J7316H | Socket, Impact 1/2" DR 1/2" 6 PT Deep | ASME B107.2 |
| J7318H | Socket, Impact 1/2" DR 9/16" 6 PT Deep | ASME B107.2 |
| J7320H | Socket, Impact 1/2" DR 5/8" 6 PT Deep | ASME B107.2 |
| J7322H | Socket, Impact 1/2" DR 11/16" 6 PT Deep | ASME B107.2 |
| J7324H | Socket, Impact 1/2" DR 3/4" 6 PT Deep | ASME B107.2 |
| J7326H | Socket, Impact 1/2" DR 13/16" 6 PT Deep | ASME B107.2 |
| J7328H | Socket, Impact 1/2" DR 7/8" 6 PT Deep | ASME B107.2 |
| J7330H | Socket, Impact 1/2" DR 15/16" 6 PT Deep | ASME B107.2 |
| J2588 | Socket, Bar 11" | |
| J2592 | Socket, Clip 1/2" DR | |

- ▶ Deep Sockets: 5/8, 11/16, 3/4, 13/16, 7/8, 15/16 Inch.
- ▶ Accessories: Socket Clip and Socket Rail.
- ▶ Weight (lbs): 4.01



1/2" DRIVE 7 PIECE IMPACT SOCKET SET - 6 POINT

Product #: **J72157**



| Contents | Description | ASME Spec. |
|----------|------------------------------------|-------------|
| J7414H | Socket, Impact 1/2" DR 7/16" 6 PT | ASME B107.2 |
| J7416H | Socket, Impact 1/2" DR 1/2" 6 PT | ASME B107.2 |
| J7418H | Socket, Impact 1/2" DR 9/16" 6 PT | ASME B107.2 |
| J7420H | Socket, Impact 1/2" DR 5/8" 6 PT | ASME B107.2 |
| J7422H | Socket, Impact 1/2" DR 11/16" 6 PT | ASME B107.2 |
| J7424H | Socket, Impact 1/2" DR 3/4" 6 PT | ASME B107.2 |
| J7426H | Socket, Impact 1/2" DR 13/16" 6 PT | ASME B107.2 |
| J2588 | Socket, Bar 11" | |
| J2592 | Socket, Clip 1/2" DR | |

- ▶ Standard Sockets: 7/16, 1/2, 9/16, 5/8, 11/16, 3/4, 13/16 Inch.
- ▶ Accessories: Socket Clip and Socket Rail.
- ▶ Weight (lbs): 3.08



1/2" DRIVE 8 PIECE DEEP UNIVERSAL IMPACT SOCKET SET - 6 POINT

Product #: **J72145**



| Contents | Description |
|----------|---|
| J75275P | Socket, Impact 1/2" DR Universal 1/2" 6 PT Deep |
| J75276P | Socket, Impact 1/2" DR Universal 9/16" 6 PT Deep |
| J75277P | Socket, Impact 1/2" DR Universal 5/8" 6 PT Deep |
| J75278P | Socket, Impact 1/2" DR Universal 11/16" 6 PT Deep |
| J75279P | Socket, Impact 1/2" DR Universal 3/4" 6 PT Deep |
| J75280P | Socket, Impact 1/2" DR Universal 13/16" 6 PT Deep |
| J75281P | Socket, Impact 1/2" DR Universal 7/8" 6 PT Deep |
| J75282P | Socket, Impact 1/2" DR Universal 15/16" 6 PT Deep |
| J2592 | Socket, Clip 1/2" DR |
| J2588 | Socket, Bar 11" |

- ▶ Universal Sockets: 1/2, 9/16, 5/8, 11/16, 3/4, 13/16, 7/8, 15/16 Inch.
- ▶ Accessories: Socket Clip and Socket Rail.
- ▶ Weight (lbs): 3.68



1/2" DRIVE 7 PIECE METRIC DEEP IMPACT UNIVERSAL SOCKET SET - 6 POINT

Product #: **J72147M**



| Contents | Description |
|----------|--|
| J75413MP | Socket, Impact 1/2" DR Universal 13 mm 6 PT Deep |
| J75414MP | Socket, Impact 1/2" DR Universal 14 mm 6 PT Deep |
| J75415MP | Socket, Impact 1/2" DR Universal 15 mm 6 PT Deep |
| J75416MP | Socket, Impact 1/2" DR Universal 16 mm 6 PT Deep |
| J75417MP | Socket, Impact 1/2" DR Universal 17 mm 6 PT Deep |
| J75418MP | Socket, Impact 1/2" DR Universal 18 mm 6 PT Deep |
| J75419MP | Socket, Impact 1/2" DR Universal 19 mm 6 PT Deep |
| J2592 | Socket, Clip 1/2" DR |
| J2588 | Socket, Bar 11" |

- ▶ Universal Sockets: 13, 14, 15, 16, 17, 18, 19 mm.
- ▶ Accessories: Socket Clip and Socket Rail.
- ▶ Weight (lbs): 4.07



1/2" DRIVE 7 PIECE METRIC UNIVERSAL IMPACT SOCKET SET - 6 POINT

METRIC

Product #: J72143M



| Contents | Description |
|----------|---|
| J74413MP | Socket, Impact 1/2" DR Universal 13 mm 6 PT |
| J74414MP | Socket, Impact 1/2" DR Universal 14 mm 6 PT |
| J74415MP | Socket, Impact 1/2" DR Universal 15 mm 6 PT |
| J74416MP | Socket, Impact 1/2" DR Universal 16 mm 6 PT |
| J74417MP | Socket, Impact 1/2" DR Universal 17 mm 6 PT |
| J74418MP | Socket, Impact 1/2" DR Universal 18 mm 6 PT |
| J74419MP | Socket, Impact 1/2" DR Universal 19 mm 6 PT |
| J2592 | Socket, Clip 1/2" DR |
| J2588 | Socket, Bar 11" |

- › Universal Sockets: 13, 14, 15, 16, 17, 18, 19 mm.
- › Accessories: Socket Clip and Socket Rail.
- › Weight (lbs) 3.32



1/2" DRIVE 7 PIECE UNIVERSAL IMPACT SOCKET SET - 6 POINT

Product #: J74142



- › Ball and spring design which allows for a 30° working angle.
- › Smooth 360° rotation.
- › Proto® 6 Point Impact Sockets are ideal for use on stubborn or damaged fasteners, and also on fasteners made from soft materials.
- › TorquePlus™ features apply.
- › Socket size stamped on tool for easy identification.
- › Side locking hole.
- › Weight (lbs): 3.24



| Contents | Description | ASME Spec. |
|----------|--|-------------|
| J74274P | Socket, Impact 1/2" DR 7/16" 6 PT Universal | ASME B107.2 |
| J74275P | Socket, Impact 1/2" DR 1/2" 6 PT Universal | ASME B107.2 |
| J74276P | Socket, Impact 1/2" DR 9/16" 6 PT Universal | ASME B107.2 |
| J74277P | Socket, Impact 1/2" DR 5/8" 6 PT Universal | ASME B107.2 |
| J74278P | Socket, Impact 1/2" DR 11/16" 6 PT Universal | ASME B107.2 |
| J74279P | Socket, Impact 1/2" DR 3/4" 6 PT Universal | ASME B107.2 |
| J74280P | Socket, Impact 1/2" DR 13/16" 6 PT Universal | ASME B107.2 |
| J2585 | Socket, Bar 9" | |
| J2592 | Socket, Clip 1/2" DR | |

1/2" DRIVE 7 PIECE HEX BIT IMPACT SOCKET SET

Product #: J74152



- › Made of forged steel.
- › Size stamped on tool for easy identification.
- › Side locking hole.
- › Weight (lbs): 2.98

| Contents | Description |
|-----------|--------------------------------------|
| J74411/4 | Socket, Impact Hex Bit 1/2" DR 1/4" |
| J74415/16 | Socket, Impact Hex Bit 1/2" DR 5/16" |
| J74413/8 | Socket, Impact Hex Bit 1/2" DR 3/8" |
| J74417/16 | Socket, Impact Hex Bit 1/2" DR 7/16" |
| J74411/2 | Socket, Impact Hex Bit 1/2" DR 1/2" |
| J74419/16 | Socket, Impact Hex Bit 1/2" DR 9/16" |
| J74415/8 | Socket, Impact Hex Bit 1/2" DR 5/8" |
| J2585 | Socket, Bar 9" |
| J2592 | Socket, Clip 1/2" DR |





1/2" DRIVE 6 PIECE METRIC HEX BIT IMPACT SOCKET SET

METRIC



Product #: **J74252**

- › Made of forged steel.
- › Size stamped on tool for easy identification.
- › Side locking hole.
- › Weight (lbs): 2.55

| Contents | Description |
|-----------|--------------------------------------|
| J7441-6M | Socket, Impact Hex Bit 1/2" DR 6 mm |
| J7441-8M | Socket, Impact Hex Bit 1/2" DR 8 mm |
| J7441-10M | Socket, Impact Hex Bit 1/2" DR 10 mm |
| J7441-12M | Socket, Impact Hex Bit 1/2" DR 12 mm |
| J7441-14M | Socket, Impact Hex Bit 1/2" DR 14 mm |
| J7441-17M | Socket, Impact Hex Bit 1/2" DR 17 mm |
| J2585 | Socket, Bar 9" |
| J2592 | Socket, Clip 1/2" DR |



1/2" DRIVE 3 PIECE LOCKING IMPACT EXTENSION SET



Product #: **J7515**

- › Solid one-piece design helps prevent the locking components from becoming loose or disengaged.
- › Patented locking feature locks sockets to the extension with exceptional force.
- › Knurled shank provides a slip-resistant grip when hand-turning the extension.
- › Weight (lbs): 2.06

| Contents | Description |
|----------|---|
| J7503 | Extension, Impact 1/2" DR x 3" Locking |
| J7505 | Extension, Impact 1/2" DR x 5" Locking |
| J7510 | Extension, Impact 1/2" DR x 10" Locking |



1/2" DRIVE IMPACT SOCKETS - 6 POINT

- ▶ Proto® 6 Point Impact Sockets are ideal for use on stubborn or damaged fasteners, and also on fasteners made from soft materials.
- ▶ TorquePlus™ features apply.



| Product # | Size (in) (A) | Nut End Outside Dia. (in) (B) | Drive End Outside Dia. (in) (C) | Nut Depth (in) (D) | Bolt Clearance Depth (in) (E) | Overall Length (in) (L) | Weight (lbs) |
|-----------|---------------|-------------------------------|---------------------------------|--------------------|-------------------------------|-------------------------|--------------|
| J7412H | 3/8 | 41/64 | 15/16 | 11/32 | 27/32 | 1-1/2 | 0.17 |
| J7414H | 7/16 | 23/32 | 15/16 | 13/32 | 27/32 | 1-1/2 | 0.18 |
| J7416H | 1/2 | 51/64 | 15/16 | 13/32 | 27/32 | 1-1/2 | 0.18 |
| J7418H | 9/16 | 7/8 | 15/16 | 7/16 | 27/32 | 1-1/2 | 0.18 |
| J7420H | 5/8 | 1 | 1 | 1/2 | 27/32 | 1-1/2 | 0.20 |
| J7422H | 11/16 | 1-1/32 | 1-1/32 | 1/2 | 27/32 | 1-1/2 | 0.22 |
| J7424H | 3/4 | 1-7/64 | 1-7/64 | 51/64 | 27/32 | 1-1/2 | 0.24 |
| J7426H | 13/16 | 1-13/64 | 1-13/64 | 11/16 | 31/32 | 1-5/8 | 0.31 |
| J7428H | 7/8 | 1-17/64 | 1-9/32 | 43/64 | 31/32 | 1-5/8 | 0.34 |
| J7430H | 15/16 | 1-23/64 | 1-23/64 | 51/64 | 1-3/32 | 1-3/4 | 0.44 |
| J7432H | 1 | 1-1/2 | 1-1/2 | 25/32 | 1-3/32 | 1-3/4 | 0.55 |
| J7434H | 1-1/16 | 1-33/64 | 1-33/64 | 25/32 | 1-3/32 | 1-3/4 | 0.53 |
| J7436H | 1-1/8 | 1-19/32 | 1-19/32 | 25/32 | 1-1/32 | 2 | 0.65 |
| J7438H | 1-3/16 | 1-19/32 | 1-19/32 | 3/4 | 1-1/64 | 2 | 0.85 |
| J7440H | 1-1/4 | 1-3/4 | 1-3/4 | 3/4 | 1-3/4 | 2 | 0.78 |
| J7442H | 1-5/16 | 1-3/4 | 1-3/4 | 13/16 | 63/64 | 2 | 0.73 |
| J7444H | 1-3/8 | 1-51/64 | 1-5/8 | 15/16 | 1-3/32 | 2-1/8 | 0.72 |
| J7446H | 1-7/16 | 1-59/64 | 1-5/8 | 1 | 1-37/64 | 2-15/64 | 0.87 |
| J7448H | 1-1/2 | 2 | 1-5/8 | 1 | 1-37/64 | 2-15/64 | 1.03 |
| J7450H | 1-9/16 | 2-1/32 | 1-5/8 | 1 | 1-1/2 | 2-1/4 | 1.16 |



ASME B107.2

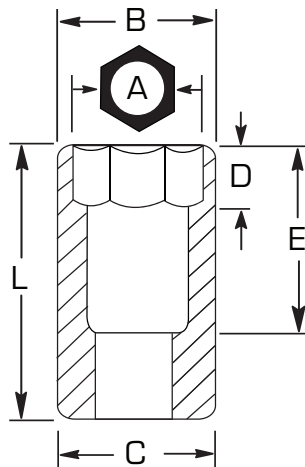

1/2" DRIVE METRIC IMPACT SOCKETS - 6 POINT



- › Proto® 6 Point Impact Sockets are ideal for use on stubborn or damaged fasteners, and also on fasteners made from soft materials.
- › TorquePlus™ features apply.



| Product # | Size (mm) (A) | Nut End Outside Dia. (in) (B) | Drive End Outside Dia. (in) (C) | Nut Depth (in) (D) | Bolt Clearance Depth (in) (E) | Overall Length (in) (L) | Weight (lbs) |
|-----------|---------------|-------------------------------|---------------------------------|--------------------|-------------------------------|-------------------------|--------------|
| J7408M | 8 | 37/64 | 15/16 | 9/32 | 27/32 | 1-1/2 | 0.18 |
| J7409M | 9 | 41/64 | 15/16 | 3/8 | 27/32 | 1-1/2 | 0.18 |
| J7410M | 10 | 43/64 | 15/16 | 3/8 | 27/32 | 1-1/2 | 0.18 |
| J7411M | 11 | 23/32 | 15/16 | 3/8 | 27/32 | 1-1/2 | 0.18 |
| J7412M | 12 | 51/64 | 15/16 | 13/32 | 27/32 | 1-1/2 | 0.17 |
| J7413M | 13 | 51/64 | 15/16 | 7/16 | 27/32 | 1-1/2 | 0.16 |
| J7414M | 14 | 7/8 | 15/16 | 15/32 | 27/32 | 1-1/2 | 0.18 |
| J7415M | 15 | 15/16 | 15/16 | 1/2 | 27/32 | 1-1/2 | 0.18 |
| J7416M | 16 | 1 | 1 | 17/32 | 27/32 | 1-1/2 | 0.20 |
| J7417M | 17 | 1-1/32 | 1-1/32 | 9/16 | 27/32 | 1-1/2 | 0.22 |
| J7418M | 18 | 1-1/8 | 1-1/8 | 51/64 | 27/32 | 1-1/2 | 0.27 |
| J7419M | 19 | 1-7/64 | 1-7/64 | 47/64 | 27/32 | 1-1/2 | 0.25 |
| J7420M | 20 | 1-5/32 | 1-5/32 | 11/16 | 31/32 | 1-5/8 | 0.30 |
| J7421M | 21 | 1-13/64 | 1-13/64 | 43/64 | 31/32 | 1-5/8 | 0.30 |
| J7422M | 22 | 1-9/32 | 1-9/32 | 43/64 | 31/32 | 1-5/8 | 0.36 |
| J7423M | 23 | 1-3/8 | 1-3/8 | 43/64 | 31/32 | 1-5/8 | 0.39 |
| J7424M | 24 | 1-23/64 | 1-23/64 | 43/64 | 31/32 | 1-5/8 | 0.43 |
| J7425M | 25 | 1-3/8 | 1-3/8 | 51/64 | 1-3/32 | 1-3/4 | 0.48 |
| J7426M | 26 | 1-1/2 | 1-1/2 | 1-1/32 | 1-11/32 | 2 | 0.54 |
| J7427M | 27 | 1-1/2 | 1-1/2 | 1-1/32 | 1-11/32 | 2 | 0.62 |
| J7428M | 28 | 1-5/8 | 1-5/8 | 1-1/32 | 1-11/32 | 2 | 0.72 |
| J7429M | 29 | 1-5/8 | 1-5/8 | 1-1/64 | 1-11/32 | 2 | 0.67 |
| J7430M | 30 | 1-33/64 | 1-33/64 | 25/32 | 1-3/32 | 2 | 0.82 |
| J7431M | 31 | 1-33/64 | 1-33/64 | 51/64 | 1-3/32 | 2 | 0.83 |
| J7432M | 32 | 1-33/64 | 1-33/64 | 51/64 | 1-3/32 | 2 | 0.75 |
| J7433M | 33 | 1-27/32 | 1-27/32 | 1-1/64 | 1-9/32 | 2 | 0.95 |
| J7434M | 34 | 1-29/32 | 1-29/32 | 1-1/64 | 1-9/32 | 2 | 1.00 |
| J7436M | 36 | 2-1/64 | 2-1/64 | 1-3/16 | 1-11/32 | 2 | 0.89 |
| J7438M | 38 | 2-5/32 | 2-5/32 | 1-3/16 | 1-11/32 | 2-3/8 | 0.96 |
| J7441M | 41 | 2-19/64 | 2-19/64 | 1-21/64 | 1-17/32 | 2-3/8 | 1.20 |
| J7446M | 46 | 2-3/8 | 2-3/8 | 63/64 | 1-17/32 | 2-7/16 | 1.24 |

ASME B107.33M



1/2" DRIVE DEEP IMPACT SOCKETS - 6 POINT

- › Proto® 6 Point Impact Sockets are ideal for use on stubborn or damaged fasteners, and also on fasteners made from soft materials.
- › TorquePlus™ fetatures apply.
- › Socket size stamped on tool for easy identification.
- › Side locking hole.



| Product # | Size (in) (A) | Nut End Outside Dia. (in) (B) | Drive End Outside Dia. (in) (C) | Nut Depth (in) (D) | Bolt Clearance Depth (in) (E) | Overall Length (in) (L) | Weight (lbs) |
|-----------|---------------|-------------------------------|---------------------------------|--------------------|-------------------------------|-------------------------|--------------|
| J7312H | 3/8 | 19/32 | 15/16 | 15/16 | 2-5/8 | 3-1/4 | 0.42 |
| J7314H | 7/16 | 23/32 | 15/16 | 11/32 | 1-5/8 | 3-1/4 | 0.44 |
| J7316H | 1/2 | 1-25/32 | 15/16 | 7/16 | 1-5/8 | 3-1/4 | 0.43 |
| J7318H | 9/16 | 7/8 | 15/16 | 1/2 | 1-5/8 | 3-1/4 | 0.41 |
| J7320H | 5/8 | 1 | 1 | 9/16 | 1-5/8 | 3-1/4 | 0.44 |
| J7322H | 11/16 | 1-1/32 | 1-1/32 | 5/8 | 2-5/8 | 3-1/4 | 0.47 |
| J7324H | 3/4 | 1-7/64 | 1-1/8 | 1-5/32 | 2-5/8 | 3-1/4 | 0.53 |
| J7326H | 13/16 | 1-3/16 | 1-3/16 | 1-5/32 | 2-5/8 | 3-1/4 | 0.62 |
| J7328H | 7/8 | 1-19/64 | 1-9/32 | 1-13/32 | 2-7/8 | 3-1/2 | 0.78 |
| J7330H | 15/16 | 1-3/8 | 1-3/8 | 1-13/32 | 2-7/8 | 3-1/2 | 0.86 |
| J7332H | 1 | 1-1/2 | 1-1/2 | 1-13/32 | 2-7/8 | 3-1/2 | 1.02 |
| J7334H | 1-1/16 | 1-1/2 | 1-33/64 | 1-17/32 | 2-7/8 | 3-1/2 | 1.11 |
| J7336H | 1-1/8 | 1-5/8 | 1-5/8 | 1-13/32 | 2-7/8 | 3-1/2 | 1.20 |
| J7338H | 1-3/16 | 1-13/16 | 1-21/32 | 1-1/64 | 2-7/8 | 3-1/2 | 1.47 |
| J7340H | 1-1/4 | 1-13/16 | 1-21/32 | 1-1/64 | 2-7/8 | 3-1/2 | 1.39 |
| J7342H | 1-5/16 | 1-7/8 | 1-21/32 | 1-1/16 | 2-7/8 | 3-1/2 | 1.41 |
| J7344H | 1-3/8 | 1-7/8 | 1-21/32 | 1-7/64 | 2-7/8 | 3-1/2 | 1.31 |
| J7346H | 1-7/16 | 2-1/16 | 1-21/32 | 1-5/32 | 2-7/8 | 3-1/2 | 1.67 |
| J7348H | 1-1/2 | 2-1/16 | 1-21/32 | 1-13/64 | 2-7/8 | 3-1/2 | 1.50 |
| J7350H | 1-9/16 | 2 | 1-5/8 | 1-1/4 | 1-1/4 | 3-1/2 | 1.80 |



ASME B107.2



THE STORY BEHIND



TorquePlus™ is a fresh look at an old problem in sockets: worn, stripped and stubborn bolts.

Conventional sockets contact the fasteners near the points of both the fastener and the socket, where they are the weakest.

Excessive force on this combination of fastener and socket can cause fastener rounding, or cut through the socket wall.

The TorquePlus™ design enables sockets to grip the fastener flats, away from the points.

- › Allows up to 15% more torque to be applied safely to the fastener.
- › Reduces the risk of fastener rounding.
- › Improves the ability to turn worn or rounded fasteners.

The TorquePlus™ design also means aerospace specifications.

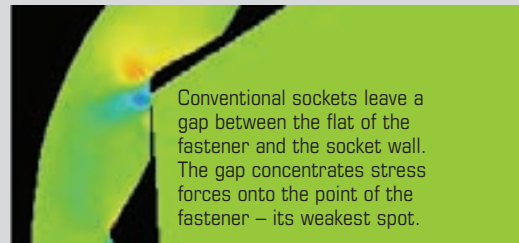

STRESS MAP of a conventional socket.

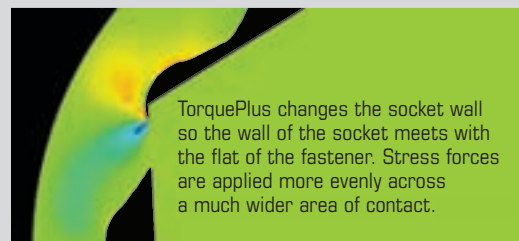

STRESS MAP of a TorquePlus socket.

1/2" DRIVE METRIC DEEP IMPACT SOCKETS - 6 POINT



- › Proto® 6 Point Impact Sockets are ideal for use on stubborn or damaged fasteners, and also on fasteners made from soft materials.
- › TorquePlus™ features apply.
- › Socket size stamped on tool for easy identification.
- › Side locking hole.



| Product # | Size (mm) (A) | Nut End Outside Dia. (in) (B) | Drive End Outside Dia. (in) (C) | Nut Depth (in) (D) | Bolt Clearance Depth (in) (E) | Overall Length (in) (L) | Weight (lbs) |
|-----------|---------------|-------------------------------|---------------------------------|--------------------|-------------------------------|-------------------------|--------------|
| J7308M | 8 | 37/64 | 7/8 | 5/16 | 2-19/32 | 3-1/4 | 0.37 |
| J7309M | 9 | 19/32 | 7/8 | 3/8 | 2-19/32 | 3-1/4 | 0.36 |
| J7310M | 10 | 41/64 | 15/16 | 7/16 | 2-19/32 | 3-1/4 | 0.43 |
| J7311M | 11 | 45/64 | 15/16 | 7/16 | 2-19/32 | 3-1/4 | 0.43 |
| J7312M | 12 | 47/64 | 15/16 | 1/2 | 2-19/32 | 3-1/4 | 0.43 |
| J7313M | 13 | 25/32 | 15/16 | 1/2 | 2-19/32 | 3-1/4 | 0.42 |
| J7314M | 14 | 55/64 | 15/16 | 1/2 | 2-19/32 | 3-1/4 | 0.40 |
| J7315M | 15 | 15/16 | 1 | 37/64 | 2-19/32 | 3-1/4 | 0.40 |
| J7316M | 16 | 1 | 1-1/32 | 19/32 | 2-19/32 | 3-1/4 | 0.46 |
| J7317M | 17 | 1-1/32 | 1-1/16 | 5/8 | 2-19/32 | 3-1/4 | 0.45 |
| J7318M | 18 | 1-1/16 | 1-1/16 | 43/64 | 2-19/32 | 3-1/4 | 0.49 |
| J7319M | 19 | 1-7/64 | 1-7/64 | 1-5/32 | 2-19/32 | 3-1/4 | 0.52 |
| J7320M | 20 | 1-5/32 | 1-5/32 | 1-5/32 | 2-19/32 | 3-1/4 | 0.55 |
| J7321M | 21 | 1-13/64 | 1-13/64 | 1-13/32 | 2-19/32 | 3-1/4 | 0.66 |
| J7322M | 22 | 1-9/32 | 1-9/32 | 1-13/32 | 2-27/32 | 3-1/2 | 0.75 |
| J7323M | 23 | 1-19/64 | 1-19/64 | 1-13/32 | 2-27/32 | 3-1/2 | 0.75 |
| J7324M | 24 | 1-23/64 | 1-23/64 | 1-13/32 | 2-27/32 | 3-1/2 | 0.81 |
| J7325M | 25 | 1-7/16 | 1-7/16 | 1-13/32 | 2-27/32 | 3-1/2 | 0.92 |
| J7326M | 26 | 1-1/2 | 1-1/2 | 1-13/32 | 2-27/32 | 3-1/2 | 1.03 |
| J7327M | 27 | 1-9/16 | 1-9/16 | 1-13/32 | 2-27/32 | 3-1/2 | 1.14 |
| J7328M | 28 | 1-5/8 | 1-5/8 | 1-13/32 | 2-27/32 | 3-1/2 | 1.20 |
| J7329M | 29 | 1-5/8 | 1-5/8 | 1-33/64 | 2-27/32 | 3-1/2 | 1.16 |
| J7330M | 30 | 1-11/16 | 1-11/16 | 1-13/32 | 2-27/32 | 3-1/2 | 1.53 |
| J7332M | 32 | 1-25/32 | 1-25/32 | 1-13/64 | 2-27/32 | 3-1/2 | 1.32 |
| J7333M | 33 | 1-55/64 | 1-55/64 | 1-25/64 | 2-27/32 | 3-1/2 | 1.48 |
| J7334M | 34 | 1-15/16 | 1-15/16 | 1-25/64 | 2-27/32 | 3-1/2 | 1.50 |
| J7335M | 35 | 2-1/16 | 2-1/16 | 1-25/64 | 2-27/32 | 3-1/2 | 1.61 |
| J7336M | 36 | 2-1/16 | 2-1/16 | 1-25/64 | 2-27/32 | 3-1/2 | 1.63 |

ASME B107.33M



1/2" DRIVE DEEP THIN WALL IMPACT SOCKETS - 6 POINT

- › Specifically designed for light clearance applications.
- › Reduced wall thickness helps improve access to fasteners in restricted areas.
- › All Impact sockets feature one through hole and a groove to accept a retaining ring and pin to secure the socket to the power tool anvil.
- › Chamfered service ends for quick and positive fastener engagement.
- › Proto® 6 Point Impact Sockets are ideal for use on stubborn or damaged fasteners, and also on fasteners made from soft materials.
- › TorquePlus™ features apply.
- › Thin wall sockets are lightweight.
- › Designed to fit into smaller spaces.
- › Thinner walls help improve productivity by making it easier to gain access to fasteners in confined spaces.
- › Extra deep length helps improve access in confined areas.
- › Often used in application where fasteners are close together, such as tire service.



| Product # | Size (in) (A) | Nut End Outside Dia. (in) (B) | Drive End Outside Dia. (in) (C) | Nut Depth (in) (D) | Bolt Clearance Depth (in) (E) | Overall Length (in) (L) | Weight (lbs) |
|-----------|---------------|-------------------------------|---------------------------------|--------------------|-------------------------------|-------------------------|--------------|
| J7312HT | 3/8 | 9/16 | 15/16 | 5/16 | 2-9/32 | 3-1/4 | 0.43 |
| J7314HT | 7/16 | 21/32 | 15/16 | 3/8 | 2-1/4 | 3-1/4 | 0.43 |
| J7316HT | 1/2 | 23/32 | 15/16 | 3/8 | 2-3/16 | 3-1/4 | 0.42 |
| J7318HT | 9/16 | 13/16 | 15/16 | 7/16 | 2-3/3 | 3-1/4 | 0.39 |
| J7320HT | 5/8 | 7/8 | 15/16 | 1/2 | 2-1/32 | 3-1/4 | 0.37 |
| J7322HT | 11/16 | 31/32 | 31/32 | 1/2 | 2 | 3-1/4 | 0.47 |
| J7324HT | 3/4 | 1-1/32 | 1-1/32 | 1-11/64 | 1-7/16 | 3-1/4 | 0.39 |
| J7326HT | 13/16 | 1-1/8 | 1-1/8 | 1-11/64 | 1-7/16 | 3-1/4 | 0.48 |
| J7328HT | 7/8 | 1-3/16 | 1-3/16 | 1-13/32 | 1-7/16 | 3-1/2 | 0.58 |
| J7330HT | 15/16 | 1-17/64 | 1-17/64 | 1-13/32 | 1-7/16 | 3-1/2 | 0.69 |
| J7332HT | 1" | 1-3/8 | 1-3/8 | 1-13/32 | 1-7/16 | 3-1/2 | 0.76 |
| J7334HT | 1-1/16 | 1-31/64 | 1-31/64 | 1-17/32 | 1-5/16 | 3-1/2 | 0.89 |
| J7336HT | 1-1/8 | 1-9/16 | 1-9/16 | 1-17/32 | 1-5/16 | 3-1/2 | 1.03 |
| J7338HT | 1-3/16 | 1-5/8 | 1-5/8 | 1-17/32 | 1-5/16 | 3-1/2 | 1.14 |
| J7340HT | 1-1/4 | 1-11/16 | 1-11/16 | 1-17/32 | 1-5/16 | 3-1/2 | 1.22 |
| J7342HT | 1-5/16 | 1-13/16 | 1-13/16 | 1-17/32 | 1-5/16 | 3-1/2 | 1.36 |
| J7344HT | 1-3/8 | 1-13/16 | 1-13/16 | 1-17/32 | 1 | 3-1/2 | 1.44 |
| J7346HT | 1-7/16 | 1-15/16 | 1-15/16 | 1-13/16 | 1 | 3-1/2 | 1.56 |
| J7348HT | 1-1/2 | 2 | 2 | 1-13/16 | 1 | 3-1/2 | 1.58 |



ASME B107.2

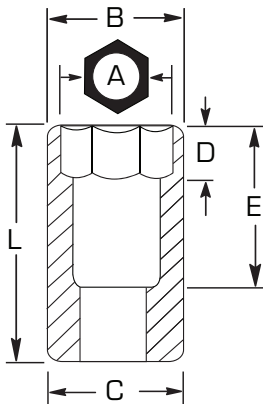

1/2" DRIVE METRIC DEEP THIN WALL IMPACT SOCKETS - 6 POINT

- › Specifically designed for light clearance applications.
- › Reduced wall thickness helps improve access to fasteners in restricted areas.
- › All Impact sockets feature one through hole and a groove to accept a retaining ring and pin to secure the socket to the power tool anvil.
- › Chamfered service ends for quick and positive fastener engagement.
- › Proto® 6 Point Impact Sockets are ideal for use on stubborn or damaged fasteners, and also on fasteners made from soft materials.
- › TorquePlus™ features apply.
- › Thin wall sockets are lightweight.
- › Designed to fit into smaller spaces.
- › Thinner walls help improve productivity by making it easier to gain access to fasteners in confined spaces.
- › Extra deep length helps improve access in confined areas.
- › Often used in application where fasteners are close together, such as tire service.



METRIC



| Product # | Size (mm) (A) | Nut End Outside Dia. (in) (B) | Drive End Outside Dia. (in) (C) | Nut Depth (in) (D) | Bolt Clearance Depth (in) (E) | Overall Length (in) (L) | Weight (lbs) |
|-----------|------------------|----------------------------------|------------------------------------|-----------------------|----------------------------------|----------------------------|--------------|
| J7310MHT | 10 | 39/64 | 15/16 | 3/8 | 2-7/32 | 3-1/4 | 0.43 |
| J7311MHT | 11 | 21/32 | 15/16 | 25/64 | 2-13/64 | 3-1/4 | 0.44 |
| J7312MHT | 12 | 11/16 | 15/16 | 7/16 | 2-5/32 | 3-1/4 | 0.45 |
| J7313MHT | 13 | 47/64 | 15/16 | 7/16 | 2-5/32 | 3-1/4 | 0.41 |
| J7314MHT | 14 | 13/16 | 15/16 | 7/16 | 2-5/32 | 3-1/4 | 0.35 |
| J7315MHT | 15 | 27/32 | 15/16 | 17/32 | 2-1/16 | 3-1/4 | 0.37 |
| J7316MHT | 16 | 7/8 | 15/16 | 17/32 | 2-1/16 | 3-1/4 | 0.37 |
| J7317MHT | 17 | 15/16 | 15/16 | 11/16 | 1-29/32 | 3-1/4 | 0.35 |
| J7318MHT | 18 | 1 | 1 | 3/4 | 1-27/32 | 3-1/4 | 0.40 |
| J7319MHT | 19 | 1-1/32 | 1-1/32 | 1-5/32 | 1-7/16 | 3-1/4 | 0.37 |
| J7320MHT | 20 | 1-1/16 | 1-1/16 | 1-5/32 | 1-7/16 | 3-1/4 | 0.41 |
| J7321MHT | 21 | 1-1/8 | 1-1/8 | 1-13/32 | 1-27/64 | 3-1/2 | 0.51 |
| J7322MHT | 22 | 1-3/16 | 1-3/16 | 1-13/32 | 1-27/64 | 3-1/2 | 0.56 |
| J7323MHT | 23 | 1-1/4 | 1-1/4 | 1-13/32 | 1-27/64 | 3-1/2 | 0.63 |
| J7324MHT | 24 | 1-5/16 | 1-5/16 | 1-13/32 | 1-27/64 | 3-1/2 | 0.72 |
| J7330MHT | 30 | 1-25/32 | 1-25/32 | 2-35/64 | 1-27/64 | 3-1/2 | 1.45 |



ASME B107.33M

1/2" DRIVE POWER SOCKET - 6 POINT

COTTON PICKER SOCKET

- › Removes and replaces spindles on cotton pickers.

| Product # | Size (in) (A) | Finish | Overall Length (in) (L) | Weight (lbs) |
|-----------|------------------|-------------|----------------------------|-----------------|
| J7336CPB | 1-1/8 | Black Oxide | 5-49/64 | 1.67 |



ASME B107.2



1/2" DRIVE IMPACT SOCKETS - 8 POINT

- ▶ Drive end chamfer and four detents help provide quick positive engagement with drive tool on any of the socket drive walls.
- ▶ Tight tolerances for snug fit on fastener.
- ▶ Large clearance holes, concentric opening and nut end chamfer make it easy to position socket on fasteners.
- ▶ Made from high-strength steel to help minimize wall thickness and provide access to fasteners in recesses and where nuts and bolts protrude.
- ▶ Impact sockets are used wherever powered drive tools are used to install or remove fasteners.
- ▶ Impact sockets are designed to withstand higher torque and force associated with impact tools in repetitive application.
- ▶ Proto® 8 Point Impact Sockets are ideal for use on stubborn or damaged fasteners, and also on fasteners made from soft materials.
- ▶ TorquePlus™ features apply.
- ▶ Socket size stamped on tool for easy identification.
- ▶ Side locking hole.



| Product # | Size (in) (A) | Nut End Outside Dia. (in) (B) | Drive End Outside Dia. (in) (C) | Nut Depth (in) (D) | Bolt Clearance Depth (in) (E) | Overall Length (in) (L) | Weight (lbs) |
|-----------|---------------|-------------------------------|---------------------------------|--------------------|-------------------------------|-------------------------|--------------|
| J7412S | 3/8 | 47/64 | 15/16 | 17/64 | 27/32 | 1-1/2 | 0.17 |
| J7414S | 7/16 | 53/64 | 15/16 | 19/64 | 27/32 | 1-1/2 | 0.18 |
| J7416S | 1/2 | 15/16 | 15/16 | 11/32 | 27/32 | 1-1/2 | 0.18 |
| J7418S | 9/16 | 1-1/32 | 1-1/32 | 3/8 | 27/32 | 1-1/2 | 0.21 |
| J7420S | 5/8 | 1-1/8 | 1-1/8 | 27/32 | 27/32 | 1-1/2 | 0.26 |
| J7422S | 11/16 | 1-3/16 | 1-3/16 | 27/32 | 27/32 | 1-1/2 | 0.27 |
| J7424S | 3/4 | 1-11/32 | 1-11/32 | 27/32 | 27/32 | 1-1/2 | 0.37 |
| J7426S | 13/16 | 1-3/8 | 1-3/8 | 27/32 | 27/32 | 1-1/2 | 0.39 |
| J7428S | 7/8 | 1-1/2 | 1-1/2 | 31/32 | 31/32 | 1-5/8 | 0.48 |
| J7430S | 15/16 | 1-5/8 | 1-5/8 | 1-1/64 | 1-3/32 | 1-3/4 | 0.62 |
| J7432S | 1 | 1-3/4 | 1-3/4 | 1-1/64 | 1-3/32 | 1-3/4 | 0.74 |
| J7434S | 1-1/16 | 1-27/32 | 1-27/32 | 1-1/64 | 1-11/32 | 1-3/4 | 0.91 |



ASME B107.2

1/2" DRIVE DEEP IMPACT SOCKETS - 8 POINT

- ▶ Proto® 8 Point Impact Sockets are ideal for use on stubborn or damaged fasteners, and also on fasteners made from soft materials.
- ▶ TorquePlus™ features apply.
- ▶ Drive end chamfer and four detents help provide quick positive engagement with drive tool on any of the socket drive walls.
- ▶ Tight tolerances for snug fit on fastener.
- ▶ Large clearance holes, concentric opening and nut end chamfer make it easy to position socket on fasteners.
- ▶ Made from high-strength steel to help minimize wall thickness and provide access to fasteners in recesses and where nuts and bolts protrude.
- ▶ Impact sockets are used wherever powered drive tools are used to install or remove fasteners.
- ▶ Impact sockets are designed to withstand higher torque and force associated with impact tools in repetitive application.
- ▶ Extra length provides easy access to fasteners in recesses or where nuts and bolts protrude.
- ▶ Socket size stamped on tool for easy identification.
- ▶ Side locking hole.



| Product # | Size (in) (A) | Nut End Outside Dia. (in) (B) | Drive End Outside Dia. (in) (C) | Nut Depth (in) (D) | Bolt Clearance Depth (in) (E) | Overall Length (in) (L) | Weight (lbs) |
|-----------|---------------|-------------------------------|---------------------------------|--------------------|-------------------------------|-------------------------|--------------|
| J7312S | 3/8 | 3/4 | 7/8 | 11/32 | 2-19/32 | 3-1/4 | 0.37 |
| J7314S | 7/16 | 27/32 | 15/16 | 3/8 | 2-19/32 | 3-1/4 | 0.44 |
| J7316S | 1/2 | 51/16 | 15/16 | 7/16 | 2-19/32 | 3-1/4 | 0.43 |
| J7318S | 9/16 | 1-1/32 | 1-1/32 | 1/2 | 2-19/32 | 3-1/4 | 0.54 |
| J7320S | 5/8 | 1-1/8 | 1-1/8 | 1/2 | 2-19/32 | 3-1/4 | 0.63 |
| J7322S | 11/16 | 1-3/16 | 1-3/16 | 1-5/32 | 2-19/32 | 3-1/4 | 0.61 |
| J7324S | 3/4 | 1-5/16 | 1-5/16 | 1-5/32 | 2-19/32 | 3-1/4 | 0.76 |
| J7326S | 13/16 | 1-3/8 | 1-3/8 | 1-5/32 | 2-19/32 | 3-1/4 | 0.83 |
| J7328S | 7/8 | 1-1/2 | 1-1/2 | 1-13/32 | 2-27/32 | 3-1/2 | 1.10 |
| J7330S | 15/16 | 1-39/64 | 1-39/64 | 1-13/32 | 2-27/32 | 3-1/2 | 1.24 |
| J7332S | 1 | 1-11/16 | 1-11/16 | 1-13/32 | 2-27/32 | 3-1/2 | 1.54 |



ASME B107.2



1/2" DRIVE IMPACT SOCKETS - 12 POINT

- › Proto® 12 Point Impact Sockets are ideal for use on stubborn or damaged fasteners, and also on fasteners made from soft materials.
- › TorquePlus™ features apply.
- › Socket size stamped on tool for easy identification.
- › Side locking hole.



| Product # | Size (in) (A) | Nut End Outside Dia. (in) (B) | Drive End Outside Dia. (in) (C) | Nut Depth (in) (D) | Bolt Clearance Depth (in) (E) | Overall Length (in) (L) | Weight (lbs) |
|-----------|---------------|-------------------------------|---------------------------------|--------------------|-------------------------------|-------------------------|--------------|
| J7412 | 3/8 | 41/64 | 15/16 | 11/32 | 27/32 | 1-1/2 | 0.16 |
| J7414 | 7/16 | 23/32 | 15/16 | 13/32 | 27/32 | 1-1/2 | 0.17 |
| J7416 | 1/2 | 51/64 | 15/16 | 13/32 | 27/32 | 1-1/2 | 0.18 |
| J7418 | 9/16 | 7/8 | 15/16 | 7/16 | 27/32 | 1-1/2 | 0.19 |
| J7420 | 5/8 | 1 | 1 | 1/2 | 27/32 | 1-1/2 | 0.20 |
| J7422 | 11/16 | 1-1/32 | 1-1/32 | 1/2 | 27/32 | 1-1/2 | 0.21 |
| J7424 | 3/4 | 1-7/64 | 1-7/64 | 51/64 | 27/32 | 1-1/2 | 0.23 |
| J7426 | 13/16 | 1-13/64 | 1-13/64 | 11/16 | 31/32 | 1-5/8 | 0.30 |
| J7428 | 7/8 | 1-9/32 | 1-9/32 | 43/64 | 31/32 | 1-5/8 | 0.34 |
| J7430 | 15/16 | 1-23/64 | 1-23/64 | 51/64 | 1-3/32 | 1-3/4 | 0.42 |
| J7432 | 1 | 1-1/2 | 1-1/2 | 25/32 | 1-3/32 | 1-3/4 | 0.53 |
| J7434 | 1-1/16 | 1-33/64 | 1-33/64 | 25/32 | 1-3/32 | 1-3/4 | 0.52 |
| J7436 | 1-1/8 | 1-19/32 | 1-19/32 | 25/32 | 1-1/32 | 2 | 0.62 |
| J7438 | 1-3/16 | 1-3/4 | 1-3/4 | 3/4 | 1-1/64 | 2 | 0.80 |
| J7440 | 1-1/4 | 1-3/4 | 1-3/4 | 3/4 | 1 | 2 | 0.77 |
| J7442 | 1-5/16 | 1-3/4 | 1-3/4 | 13/16 | 63/64 | 2 | 0.72 |
| J7444 | 1-3/8 | 1-51/64 | 1-5/8 | 13/16 | 1-3/32 | 2-1/8 | 0.70 |
| J7446 | 1-7/16 | 1-59/64 | 1-5/8 | 1 | 1-37/64 | 2-15/64 | 0.80 |
| J7448 | 1-1/2 | 2 | 1-5/8 | 1 | 1-37/64 | 2-15/64 | 0.97 |



AS954E S3.8.1

ASME B107.2

1/2" DRIVE METRIC IMPACT SOCKETS - 12 POINT

- › Proto® 12 Point Impact Sockets are ideal for use on stubborn or damaged fasteners, and also on fasteners made from soft materials.
- › TorquePlus™ features apply.
- › Socket size stamped on tool for easy identification.
- › Side locking hole.



METRIC

| Product # | Size (mm) (A) | Nut End Outside Dia. (in) (B) | Drive End Outside Dia. (in) (C) | Nut Depth (in) (D) | Bolt Clearance Depth (in) (E) | Overall Length (in) (L) | Weight (lbs) |
|-----------|---------------|-------------------------------|---------------------------------|--------------------|-------------------------------|-------------------------|--------------|
| J7410MT | 10 | 39/64 | 57/64 | 1/4 | 21/32 | 1-1/2 | 0.16 |
| J7411MT | 11 | 21/32 | 15/16 | 9/32 | 21/32 | 1-1/2 | 0.16 |
| J7412MT | 12 | 11/16 | 15/16 | 5/16 | 21/32 | 1-1/2 | 0.18 |
| J7413MT | 13 | 47/64 | 15/16 | 11/32 | 21/32 | 1-1/2 | 0.15 |
| J7414MT | 14 | 51/64 | 15/16 | 3/8 | 21/32 | 1-1/2 | 0.15 |
| J7415MT | 15 | 27/32 | 15/16 | 7/16 | 21/32 | 1-1/2 | 0.16 |
| J7416MT | 16 | 7/8 | 15/16 | 7/16 | 21/32 | 1-1/2 | 0.15 |
| J7417MT | 17 | 15/16 | 15/16 | 7/16 | 21/32 | 1-1/2 | 0.15 |
| J7418MT | 18 | 1 | 1 | 7/16 | 21/32 | 1-1/2 | 0.18 |
| J7419MT | 19 | 1-1/32 | 1-1/32 | 27/32 | 21/32 | 1-1/2 | 0.17 |
| J7420MT | 20 | 1-1/8 | 1-1/16 | 27/32 | 21/32 | 1-1/2 | 0.18 |
| J7421MT | 21 | 1-3/16 | 1-1/8 | 27/32 | 21/32 | 1-1/2 | 0.43 |
| J7422MT | 22 | 1-1/4 | 1-3/16 | 27/32 | 21/32 | 1-1/2 | 0.25 |
| J7423MT | 23 | 1-5/16 | 1-1/4 | 27/32 | 21/32 | 1-1/2 | 0.30 |
| J7424MT | 24 | 1-13/32 | 1-5/16 | 27/32 | 21/32 | 1-1/2 | 0.32 |
| J7430MT | 30 | 1-11/16 | 1-5/8 | 1-1/32 | 1-11/32 | 2 | 0.58 |
| J7432MT | 32 | 1-25/32 | 1-5/8 | 1-1/32 | 1-11/32 | 2 | 0.64 |



AS954E S3.8.1

ASME B107.33M



1/2" DRIVE DEEP IMPACT SOCKETS - 12 POINT

- ▶ Proto® 12 Point Impact Sockets are ideal for use on stubborn or damaged fasteners, and also on fasteners made from soft materials.
- ▶ TorquePlus™ features apply.
- ▶ Socket size stamped on tool for easy identification.
- ▶ Side locking hole.



| Product # | Size (in) (A) | Nut End Outside Dia. (in) (B) | Drive End Outside Dia. (in) (C) | Nut Depth (in) (D) | Bolt Clearance Depth (in) (E) | Overall Length (in) (L) | Weight (lbs) |
|-----------|---------------|-------------------------------|---------------------------------|--------------------|-------------------------------|-------------------------|--------------|
| J7312 | 3/8 | 19/32 | 15/16 | 5/16 | 2-19/32 | 3-1/4 | 0.43 |
| J7314 | 7/16 | 23/32 | 15/16 | 3/8 | 2-5/8 | 3-1/4 | 0.42 |
| J7316 | 1/2 | 1-25/32 | 15/16 | 7/16 | 2-5/8 | 3-1/4 | 0.45 |
| J7318 | 9/16 | 7/8 | 15/16 | 1/2 | 2-5/8 | 3-1/4 | 0.40 |
| J7320 | 5/8 | 1 | 1 | 9/16 | 2-5/8 | 3-1/4 | 0.45 |
| J7322 | 11/16 | 1-1/32 | 1-1/32 | 5/8 | 2-5/8 | 3-1/4 | 0.45 |
| J7324 | 3/4 | 1-7/64 | 1-1/8 | 1-5/32 | 2-5/8 | 3-1/4 | 0.47 |
| J7326 | 13/16 | 1-3/16 | 1-3/16 | 1-5/32 | 2-5/8 | 3-1/4 | 0.56 |
| J7328 | 7/8 | 1-19/64 | 1-19/64 | 1-13/32 | 2-7/8 | 3-1/2 | 0.68 |
| J7330 | 15/16 | 1-3/8 | 1-3/8 | 1-13/32 | 2-7/8 | 3-1/2 | 0.82 |
| J7332 | 1 | 1-1/2 | 1-1/2 | 1-13/32 | 2-7/8 | 3-1/2 | 0.99 |
| J7334 | 1-1/16 | 1-1/2 | 1-1/2 | 1-17/32 | 2-7/8 | 3-1/2 | 0.94 |
| J7336 | 1-1/8 | 1-19/32 | 1-19/32 | 1-13/32 | 2-7/8 | 3-1/2 | 1.06 |
| J7338 | 1-3/16 | 43/64 | 43/64 | 1-13/64 | 2-7/8 | 3-1/2 | 1.17 |
| J7340 | 1-1/4 | 1-3/4 | 1-3/4 | 1-13/64 | 2-7/8 | 3-1/2 | 1.23 |
| J7342 | 1-5/16 | 1-27/32 | 1-27/32 | 1-13/64 | 2-7/8 | 3-1/2 | 1.37 |
| J7344 | 1-3/8 | 1-29/32 | 1-29/32 | 1-13/64 | 2-7/8 | 3-1/2 | 1.54 |
| J7346 | 1-7/16 | 2 | 2 | 1-13/64 | 2-7/8 | 3-1/2 | 1.62 |
| J7348 | 1-1/2 | 2-1/16 | 2-1/16 | 1-13/64 | 2-7/8 | 3-1/2 | 1.76 |



AS954E S3.8.1

ASME B107.2

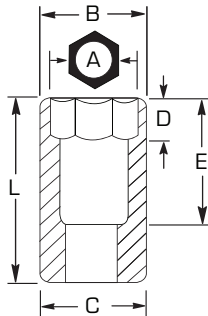

1/2" DRIVE HIGH STRENGTH MAGNETIC IMPACT SOCKETS - 6 POINT

- ▶ ProtoGrip™ Magnetic Sockets use high-strength magnets made from a rare earth magnet alloy/nylon blend.
- ▶ ProtoGrip™ Magnetic Sockets require no bushings to hold the magnet in place. This allows room for more magnet material, helping increase total magnetic strength.
- ▶ Designed to easily pick up heavy fasteners and hold them tightly during use.
- ▶ Strong magnetic hold helps increase efficiency when installing fasteners in awkward or hard-to-reach locations.
- ▶ Power sockets with high surface hardness are used in high-speed assembly operations. Ideal for nut runners.



| Product # | Size (in) (A) | Nut End Outside Dia. (in) (B) | Drive End Outside Dia. (in) (C) | Nut Depth (in) (D) | Overall Length (in) (L) | Weight (lbs) |
|-----------|---------------|-------------------------------|---------------------------------|--------------------|-------------------------|--------------|
| J7412HF | 3/8 | 47/64 | 15/16 | 15/64 | 1-1/2 | 0.18 |
| J7414HF | 7/16 | 45/64 | 15/16 | 1/4 | 1-1/2 | 0.19 |
| J7416HF | 1/2 | 25/32 | 15/16 | 17/64 | 1-1/2 | 0.19 |
| J7418HF | 9/16 | 7/8 | 15/16 | 21/64 | 1-1/2 | 0.20 |
| J7420HF | 5/8 | 1 | 1 | 25/64 | 1-1/2 | 0.23 |



ASME B107.2

1/2" DRIVE METRIC HIGH STRENGTH MAGNETIC IMPACT SOCKETS - 6 POINT

METRIC

- › ProtoGrip™ Magnetic Sockets use high-strength magnets made from a rare earth magnet alloy/nylon blend.
- › ProtoGrip™ Magnetic Sockets require no bushings to hold the magnet in place. This allows room for more magnet material, helping increase total magnetic strength.
- › Designed to easily pick up heavy fasteners and hold them tightly during use.
- › Strong magnetic hold helps increase efficiency when installing fasteners in awkward or hard-to-reach locations.
- › Power sockets with high surface hardness are used in high-speed assembly operations. Ideal for nut runners.



| Product # | Size (mm) (A) | Nut End Outside Dia. (in) (B) | Drive End Outside Dia. (in) (C) | Nut Depth (in) (D) | Overall Length (in) (L) | Weight (lbs) |
|-----------|------------------|----------------------------------|------------------------------------|-----------------------|----------------------------|--------------|
| J7410MHF | 10 | 41/64 | 15/16 | 7/32 | 1-1/2 | 0.19 |
| J7413MHF | 13 | 51/64 | 15/16 | 17/64 | 1-1/2 | 0.19 |
| J7414MHF | 14 | 15/16 | 15/16 | 9/32 | 1-1/2 | 0.20 |
| J7415MHF | 15 | 15/16 | 15/16 | 9/32 | 1-1/2 | 0.21 |
| J7418MHF | 18 | 1-1/16 | 1-1/16 | 13/32 | 1-1/2 | 0.27 |



ASME B107.2

1/2" DRIVE IMPACT HEX BIT SOCKETS

- › Proto® Hex Bit Impact Sockets can be used on stubborn fasteners.
- › Tight tolerances for snug fit on fastener.
- › Hex bit impact sockets are used wherever powered drive tools are used to install or remove fasteners.
- › Hex Bit impact Sockets are designed to withstand the high torque and force associated with impact tools in repetitive application.
- › Side locking hole.

| Product # | Size (in) (A) | Bit Length (in) | Overall Length (in) | Weight (lbs) |
|-----------|------------------|--------------------|------------------------|-----------------|
| J74411/4 | 1/4 | 1-3/4 | 3-1/4 | 0.18 |
| J74415/16 | 5/16 | 1-3/4 | 3-1/4 | 0.22 |
| J74413/8 | 3/8 | 1-3/4 | 3-1/4 | 0.24 |
| J74417/16 | 7/16 | 1-3/4 | 3-1/4 | 0.27 |
| J74411/2 | 1/2 | 1-7/8 | 3-5/8 | 0.47 |
| J74419/16 | 9/16 | 1-7/8 | 3-5/8 | 0.49 |
| J74415/8 | 5/8 | 2 | 4 | 0.84 |



1/2" DRIVE METRIC IMPACT HEX BIT SOCKETS

METRIC

- › Replaceable bit.
- › Size stamped on tool for easy identification.
- › Side locking hole.

| Product # | Size (mm) | Bit Length (in) | Overall Length (in) | Weight (lbs) |
|-----------|-----------|-----------------|---------------------|--------------|
| J7441-6M | 6 | 1-3/4 | 3-1/4 | 0.19 |
| J7441-8M | 8 | 1-3/4 | 3-1/4 | 0.21 |
| J7441-10M | 10 | 1-3/4 | 3-1/4 | 0.26 |
| J7441-12M | 12 | 1-3/4 | 3-1/4 | 0.29 |
| J7441-14M | 14 | 1-7/8 | 3-5/8 | 0.49 |
| J7441-17M | 17 | 2 | 4 | 0.88 |



IMPACT & POWER SOCKETS



1/2" DRIVE TORX® IMPACT SOCKETS

- › Proto® Torx® Impact Sockets can be used on stubborn Torx® fasteners.
- › Tight tolerances for snug fit on fastener.
- › Torx® Impact Sockets are used wherever power drive tools are used to help install or remove fasteners.
- › Torx® Impact Sockets are designed to withstand the high torque and force associated with impact tools in repetitive applications.
- › Socket size stamped on tool for easy identification.
- › Side locking hole.



| Product # | Torx® Size | Nut End Outside Dia. (in) (B) | Drive End Outside Dia. (in) (C) | Nut Depth (in) (D) | Bolt Clearance Depth (in) (E) | Overall Length (in) (L) | Weight (lbs) |
|-----------|------------|-------------------------------|---------------------------------|--------------------|-------------------------------|-------------------------|--------------|
| J7414TX | E14 | 11/16 | 7/8 | 7/16 | 27/32 | 11/2 | 0.14 |
| J7416TX | E16 | 11/16 | 7/8 | 7/16 | 27/32 | 11/2 | 0.13 |
| J7418TX | E18 | 27/32 | 7/8 | 17/32 | 27/32 | 11/2 | 0.14 |
| J7420TX | E20 | 15/16 | 15/16 | 19/32 | 27/32 | 11/2 | 0.17 |



1/2-INCH DRIVE IMPACT SOCKETS

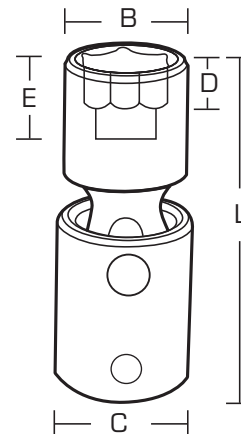
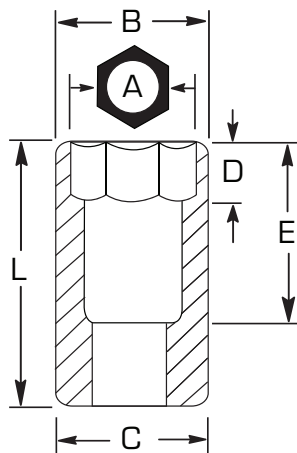



1/2" DRIVE IMPACT UNIVERSAL SOCKETS - 6 POINT

- › Ball and spring design which allows for a 30° working angle.
- › Smooth 360° rotation.
- › Proto® 6 Point Impact Sockets are ideal for use on stubborn or damaged fasteners, and also on fasteners made from soft materials.
- › TorquePlus™ features apply.



| Product # | Size (in) | Nut End Outside Dia. (in) (B) | Drive End Outside Dia. (in) (C) | Nut Depth (in) (D) | Bolt Clearance Depth (in) (E) | Overall Length (in) (L) | Weight (lbs) |
|-----------|-----------|-------------------------------|---------------------------------|--------------------|-------------------------------|-------------------------|--------------|
| J74274P | 7/16 | 3/4 | 1-1/16 | 1/2 | 3/4 | 2-19/32 | 0.34 |
| J74275P | 1/2 | 3/4 | 1-1/16 | 1/2 | 3/4 | 2-19/32 | 0.34 |
| J74276P | 9/16 | 27/32 | 1-1/16 | 1/2 | 3/4 | 2-19/32 | 0.36 |
| J74277P | 5/8 | 15/16 | 1-1/16 | 1/2 | 3/4 | 2-19/32 | 0.38 |
| J74278P | 11/16 | 1-1/16 | 1-1/4 | 1/2 | 3/4 | 2-19/32 | 0.56 |
| J74279P | 3/4 | 1-3/32 | 1-1/4 | 1/2 | 3/4 | 2-19/32 | 0.54 |
| J74280P | 13/16 | 1-3/16 | 1-1/4 | 1/2 | 3/4 | 2-19/32 | 0.56 |
| J74281P | 7/8 | 1-1/4 | 1-1/4 | 1/2 | 3/4 | 2-19/32 | 0.58 |
| J74282P | 15/16 | 1-5/16 | 1-3/8 | 1/2 | 3/4 | 2-27/32 | 0.69 |
| J74283P | 1 | 1-11/32 | 1-3/8 | 1/2 | 3/4 | 2-27/32 | 1.71 |
| J74284P | 1-1/16 | 1-13/32 | 1-3/8 | 9/16 | 13/16 | 2-15/16 | 1.72 |
| J74285P | 1-1/8 | 1-31/64 | 1-3/8 | 5/8 | 7/8 | 3-1/32 | 1.80 |
| J74286P | 1-3/16 | 1-9/16 | 1-3/8 | 11/16 | 57/64 | 3-3/32 | 1.83 |
| J74287P | 1-1/4 | 1-5/8 | 1-3/8 | 3/4 | 1-1/32 | 3-3/16 | 1.86 |
| J74288P | 1-15/16 | 1-45/64 | 1-3/8 | 13/16 | 1 | 3-9/32 | 1.86 |



1/2" DRIVE METRIC UNIVERSAL IMPACT SOCKETS - 6 POINT



| Product # | Drive End Outside Dia. | | Bolt Clearance Depth | | Overall Length (in) (L) | Weight (lbs) |
|-----------|------------------------|----------|----------------------|----------|-------------------------|--------------|
| | Size (mm) | (in) (C) | Nut Depth (in) (D) | (in) (E) | | |
| J74413MP | 13 | 1-1/16 | 1/2 | 3/4 | 2-5/8 | 0.34 |
| J74414MP | 14 | 1-1/16 | 1/2 | 3/4 | 2-5/8 | 0.39 |
| J74415MP | 15 | 1-1/16 | 1/2 | 3/4 | 2-5/8 | 0.43 |
| J74416MP | 16 | 1-1/16 | 1/2 | 3/4 | 2-5/8 | 0.48 |
| J74417MP | 17 | 1-1/4 | 1/2 | 3/4 | 2-5/8 | 0.53 |
| J74418MP | 18 | 1-1/4 | 1/2 | 3/4 | 2-5/8 | 0.54 |
| J74419MP | 19 | 1-1/4 | 1/2 | 3/4 | 2-5/8 | 0.54 |
| J74421MP | 21 | 1-1/4 | 1/2 | 3/4 | 2-5/8 | 0.54 |
| J74422MP | 22 | 1-1/4 | 1/2 | 3/4 | 2-5/8 | 0.58 |
| J74424MP | 24 | 1-1/4 | 1/2 | 3/4 | 2-5/8 | 0.58 |



1/2" DRIVE DEEP UNIVERSAL IMPACT SOCKETS - 6 POINT



| Product # | Drive End Outside Dia. | | Bolt Clearance Depth | | Overall Length (in) (L) | Weight (lbs) |
|-----------|------------------------|----------|----------------------|----------|-------------------------|--------------|
| | Size (in) | (in) (C) | Nut Depth (in) (D) | (in) (E) | | |
| J75275P | 1/2 | 1-1/16 | 11/16 | 1-5/8 | 3-9/16 | 0.41 |
| J75276P | 9/16 | 1-1/16 | 11/16 | 1-5/8 | 3-9/16 | 0.43 |
| J75277P | 5/8 | 1-1/16 | 11/16 | 1-21/32 | 3-9/16 | 0.45 |
| J75278P | 11/16 | 1-1/4 | 11/16 | 1-21/32 | 3-1/2 | 0.50 |
| J75279P | 3/4 | 1-1/4 | 11/16 | 1-39/64 | 3-1/2 | 0.55 |
| J75280P | 13/16 | 1-1/4 | 11/16 | 1-5/8 | 3-1/2 | 0.61 |
| J75281P | 7/8 | 1-1/4 | 11/16 | 1-5/8 | 3-1/2 | 0.73 |
| J75282P | 15/16 | 1-3/8 | 11/16 | 1-43/64 | 3-23/32 | 0.80 |



1/2" DRIVE METRIC DEEP UNIVERSAL IMPACT SOCKETS - 6 POINT



METRIC

| Product # | Drive End Outside Dia. | | Bolt Clearance Depth | | Overall Length (in) (L) | Weight (lbs) |
|-----------|------------------------|----------|----------------------|----------|-------------------------|--------------|
| | Size (mm) | (in) (C) | Nut Depth (in) (D) | (in) (E) | | |
| J75413MP | 13 | 1-1/16 | 11/16 | 1-5/8 | 3-1/2 | 0.43 |
| J75414MP | 14 | 1-1/16 | 11/16 | 1-5/8 | 3-1/2 | 0.45 |
| J75415MP | 15 | 1-1/16 | 11/16 | 1-5/8 | 3-1/2 | 0.50 |
| J75416MP | 16 | 1-1/16 | 11/16 | 1-5/8 | 3-1/2 | 0.55 |
| J75417MP | 17 | 1-1/4 | 11/16 | 1-5/8 | 3-1/2 | 0.61 |
| J75418MP | 18 | 1-1/4 | 11/16 | 1-5/8 | 3-1/2 | 0.73 |
| J75419MP | 19 | 1-1/4 | 11/16 | 1-5/8 | 3-1/2 | 0.80 |



1/2" DRIVE IMPACT UNIVERSAL JOINT

- ▶ Tight tolerances for snug fit on fastener.
- ▶ Used wherever powered drive tools are used to install or remove fasteners.
- ▶ Designed to withstand the high torque and force associated with impact tools in repetitive application.
- ▶ Features two through holes and a groove to accept a Proto® Retaining Ring or pin and O-ring to help secure the socket to the drive tool anvil.
- ▶ Position at appropriate angle to turn fasteners where obstructions prevent a straight application.
- ▶ Ball and spring design which allows for a 30° working angle.
- ▶ Smooth 360° rotation.

| Product # | Overall Length (in) (L) | Weight (lbs) |
|-----------|-------------------------|--------------|
| J74470P | 2-19/32 | 0.57 |



ASME B107.2



1/2" DRIVE ADAPTERS

- ▶ Use adapters to help increase or decrease drive end size.
- ▶ Do not use hand adapters with power tools.
- ▶ Do not over torque small sockets when using them with adapters on large drive tools.
- ▶ Size stamped on tool for easy identification.
- ▶ Side locking hole.

| Product # | Size (in) | Overall Length (in) (L) | Weight (lbs) |
|-----------|-----------------|-------------------------|--------------|
| J7650 | 3/8" F x 1/2" M | 1-5/16 | 0.13 |
| J7651 | 1/2" F x 3/8" M | 1-7/16 | 0.12 |
| J7652 | 1/2" F x 3/4" M | 1-29/32 | 0.35 |
| J7653 | 3/4" F x 1/2" M | 2-1/16 | 0.48 |
| J7655 | 5/8" F x 1/2" M | 1-53/64 | 0.34 |



ASME B107.2





1/2" DRIVE EXTENSIONS

- › Use extensions to gain access to fasteners in locations that would otherwise be difficult to reach.
- › Male square is oriented in-line with female squares for use with fixed head torque wrenches.
- › Full chamfer at drive opening (when applicable) for easy engagement with drive tools.
- › Drive end chamfer and four detents help provide quick positive engagement with drive tool on any of the socket drive walls.
- › Size stamped on tool for easy identification.
- › Side locking hole.

| Product # | Overall Length (in) (L) | Weight (lbs) |
|-----------------|-------------------------|--------------|
| J7180P | 2 | 0.19 |
| J7182P | 3 | 0.3 |
| J7181P | 5 | 0.47 |
| J7184P | 9 | 0.89 |
| J7183-00 | 10 | 0.89 |

 ASME B107.2



1/2" DRIVE LOCKING EXTENSIONS

- › Solid one-piece design helps prevent the locking components from becoming loose or disengaged.
- › Patented locking feature locks sockets to the extension with exceptional force.
- › Knurled shank provides a slip-resistant grip when hand-turning the extension.

| Product # | Size (in) | Overall Length (in) (L) | Weight (lbs) |
|--------------|----------------|-------------------------|--------------|
| J7503 | 7/8" W x 3" L | 3 | 0.34 |
| J7505 | 7/8" W x 5" L | 5 | 0.57 |
| J7510 | 7/8" W x 10" L | 10 | 1.04 |



1/2" DRIVE RETAINING RINGS

- › Retaining Rings are used to help secure sockets onto drive tools.
- › They are not intended to bear any load.
- › The rotational forces are between the drive tool and the socket.
- › One-piece construction, no loose parts.



| Product # | Description | For Groove Dia (in) | Diameter (in) | Height (in) | Weight (lbs) |
|-----------------|----------------------------------|---------------------|---------------|-------------|--------------|
| JRR50080 | Retaining Ring, 1/2" DR 800 GRV | 51/64 | 15/16 | 1/8 | 0.01 |
| JRR50087 | Retaining Ring, 1/2" DR 870 GRV | 7/8 | 1 | 1/8 | 0.01 |
| JRR50095 | Retaining Ring, 1/2" DR 950 GRV | 61/64 | 1-1/16 | 1/8 | 0.01 |
| JRR50105 | Retaining Ring, 1/2" DR 1050 GRV | 1-1/16 | 1-3/16 | 1/8 | 0.01 |
| JRR50115 | Retaining Ring, 1/2" DR 1150 GRV | 1-5/32 | 1-1/4 | 1/8 | 0.01 |
| JRR50130 | Retaining Ring, 1/2" DR 1300 GRV | 1-5/16 | 1-7/16 | 1/8 | 0.01 |
| JRR50145 | Retaining Ring, 1/2" DR 1450 GRV | 1-7/16 | 1-9/16 | 1/8 | 0.01 |
| JRR50160 | Retaining Ring, 1/2" DR 1600 GRV | 1-19/32 | 1-3/4 | 1/8 | 0.01 |



3/4" DRIVE 21 PIECE METRIC IMPACT SOCKET SET - 6 POINT

METRIC

Product #: J72103M



- ▶ Proto® 6 Point Impact Sockets are ideal for use on stubborn or damaged fasteners, and also on fasteners made from soft materials.
- ▶ The TorquePlus™ features apply.
- ▶ Stamped size for easy reference.
- ▶ Side locking hole.
- ▶ Weight (lbs): 14.91



| Contents | Description | ASME Spec. |
|----------|-----------------------------------|---------------|
| J07519M | Socket, Impact 3/4" DR 19 mm 6 PT | ASME B107.33M |
| J07520M | Socket, Impact 3/4" DR 20 mm 6 PT | ASME B107.33M |
| J07521M | Socket, Impact 3/4" DR 21 mm 6 PT | ASME B107.33M |
| J07522M | Socket, Impact 3/4" DR 22 mm 6 PT | ASME B107.33M |
| J07523M | Socket, Impact 3/4" DR 23 mm 6 PT | ASME B107.33M |
| J07524M | Socket, Impact 3/4" DR 24 mm 6 PT | ASME B107.33M |
| J07525M | Socket, Impact 3/4" DR 25 mm 6 PT | ASME B107.33M |
| J07526M | Socket, Impact 3/4" DR 26 mm 6 PT | ASME B107.33M |
| J07527M | Socket, Impact 3/4" DR 27 mm 6 PT | ASME B107.33M |
| J07528M | Socket, Impact 3/4" DR 28 mm 6 PT | ASME B107.33M |
| J07529M | Socket, Impact 3/4" DR 29 mm 6 PT | ASME B107.33M |
| J07530M | Socket, Impact 3/4" DR 30 mm 6 PT | ASME B107.33M |
| J07531M | Socket, Impact 3/4" DR 31 mm 6 PT | ASME B107.33M |
| J07532M | Socket, Impact 3/4" DR 32 mm 6 PT | ASME B107.33M |
| J07533M | Socket, Impact 3/4" DR 33 mm 6 PT | ASME B107.33M |
| J07534M | Socket, Impact 3/4" DR 34 mm 6 PT | ASME B107.33M |
| J07535M | Socket, Impact 3/4" DR 35 mm 6 PT | ASME B107.33M |
| J07536M | Socket, Impact 3/4" DR 36 mm 6 PT | ASME B107.33M |
| J07538M | Socket, Impact 3/4" DR 38 mm 6 PT | ASME B107.33M |
| J07540M | Socket, Impact 3/4" DR 40 mm 6 PT | ASME B107.33M |
| J07541M | Socket, Impact 3/4" DR 41 mm 6 PT | ASME B107.33M |
| J2587 | Socket, Bar 17" | |
| J2594 | Socket, Clip 3/4" DR | |





3/4" DRIVE 15 PIECE IMPACT SOCKET SET - 6 POINT

Product #: J73105



- › Proto® 6 Point Impact Sockets are ideal for use on stubborn or damaged fasteners, and also on fasteners made from soft materials.
- › The TorquePlus™ features apply.
- › Stamped size for easy reference.
- › Side locking hole.
- › Weight (lbs): 10.65



| Contents | Description | ASME Spec. |
|----------|-------------------------------------|-------------|
| J07512 | Socket, Impact 3/4" DR 3/4" 6 PT | ASME B107.2 |
| J07513 | Socket, Impact 3/4" DR 13/16" 6 PT | ASME B107.2 |
| J07514 | Socket, Impact 3/4" DR 7/8" 6 PT | ASME B107.2 |
| J07515 | Socket, Impact 3/4" DR 15/16" 6 PT | ASME B107.2 |
| J07516 | Socket, Impact 3/4" DR 1" 6 PT | ASME B107.2 |
| J07517 | Socket, Impact 3/4" DR 1-1/16" 6 PT | ASME B107.2 |
| J07518 | Socket, Impact 3/4" DR 1-1/8" 6 PT | ASME B107.2 |
| J07519 | Socket, Impact 3/4" DR 1-3/16" 6 PT | ASME B107.2 |
| J07520 | Socket, Impact 3/4" DR 1-1/4" 6 PT | ASME B107.2 |
| J07521 | Socket, Impact 3/4" DR 1-5/16" 6 PT | ASME B107.2 |
| J07522 | Socket, Impact 3/4" DR 1-3/8" 6 PT | ASME B107.2 |
| J07523 | Socket, Impact 3/4" DR 1-7/16" 6 PT | ASME B107.2 |
| J07524 | Socket, Impact 3/4" DR 1-1/2" 6 PT | ASME B107.2 |
| J07525 | Socket, Impact 3/4" DR 1-9/16" 6 PT | ASME B107.2 |
| J07526 | Socket, Impact 3/4" DR 1-5/8" 6 PT | ASME B107.2 |
| J2587 | Socket, Bar 17" | |
| J2594 | Socket, Clip 3/4" DR | |

PRODUCT FEATURES AND BENEFITS —



- › High performance drive configuration allows for quick and easy socket engagement to the fastener flats, not the corners.
- › Employs a radius-corner design, shifting contact area and stress away from the fastener corners and distributing contact stresses over a large area of the socket, minimizing slippage.
- › The internal design minimizes fastener rounding, helps to extend fastener life, and allows the user to more easily turn worn, rounded, or rusted fasteners.

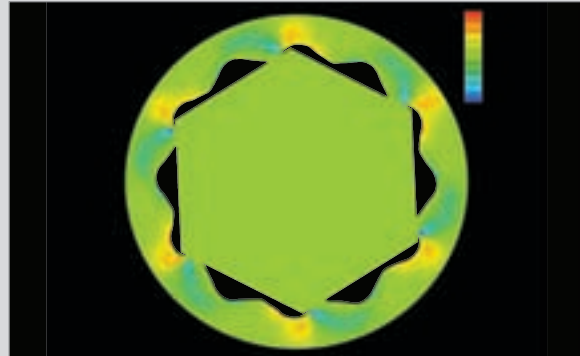

3/4" DRIVE 10 PIECE IMPACT SOCKET SET - 6 POINT

Product #: **J07500-10**



- ▶ Proto® 6 Point Impact Sockets are ideal for use on stubborn or damaged fasteners, and also on fasteners made from soft materials.
- ▶ The TorquePlus™ features apply.
- ▶ Stamped size for easy reference.
- ▶ Side locking hole.
- ▶ Weight (lbs): 7.10



| Contents | Description | ASME Spec. |
|----------|-------------------------------------|-------------|
| J07512 | Socket, Impact 3/4" DR 3/4" 6 PT | ASME B107.2 |
| J07513 | Socket, Impact 3/4" DR 13/16" 6 PT | ASME B107.2 |
| J07514 | Socket, Impact 3/4" DR 7/8" 6 PT | ASME B107.2 |
| J07515 | Socket, Impact 3/4" DR 15/16" 6 PT | ASME B107.2 |
| J07516 | Socket, Impact 3/4" DR 1" 6 PT | ASME B107.2 |
| J07517 | Socket, Impact 3/4" DR 1-1/16" 6 PT | ASME B107.2 |
| J07518 | Socket, Impact 3/4" DR 1-1/8" 6 PT | ASME B107.2 |
| J07519 | Socket, Impact 3/4" DR 1-3/16" 6 PT | ASME B107.2 |
| J07520 | Socket, Impact 3/4" DR 1-1/4" 6 PT | ASME B107.2 |
| J07521 | Socket, Impact 3/4" DR 1-5/16" 6 PT | ASME B107.2 |

3/4" DRIVE 5 PIECE IMPACT HEX BIT SET

Product #: **J07595**



- ▶ Stamped size for easy reference.
- ▶ Side locking hole.
- ▶ Weight (lbs): 0.33

| Contents | Description |
|------------|--------------------------------------|
| J075909/16 | Socket, Impact 3/4" DR Hex Bit 9/16" |
| J075905/8 | Socket, Impact 3/4" DR Hex Bit 5/8" |
| J075903/4 | Socket, Impact 3/4" DR Hex Bit 3/4" |
| J075907/8 | Socket, Impact 3/4" DR Hex Bit 7/8" |
| J075901 | Socket, Impact 3/4" DR Hex Bit 1" |
| J2576 | Socket, Bar 3/4" Drive 9" - 5 Clips |



3/4" DRIVE IMPACT SOCKETS - 4 POINT

- › Drive end chamfer and four detents help provide quick positive engagement with drive tool on any of the socket drive walls.
- › Tight tolerances for snug fit on fastener.
- › Large clearance holes, concentric opening and nut end chamfer make it easy to position socket on fasteners.
- › Made from high-strength steel to help minimize wall thickness and provide access to fasteners in recesses and where nuts and bolts protrude.
- › Impact sockets are used where ever powered drive tools are used to install or remove fasteners.
- › Impact sockets are designed to withstand the high torque and force associated with impact tools in repetitive application.
- › Features two through holes and a groove to accept a Proto® Retaining Ring or pin and O-ring to help secure the socket to the drive tool anvil.
- › Stamped size for easy reference.
- › Side locking hole.



| Product # | Nut End | | Drive End | Nut | Bolt Clearance | Overall Length | Weight (lbs) |
|-----------------|---------------|-----------------------|-----------------------|----------------|----------------|----------------|--------------|
| | Size (in) (A) | Outside Dia. (in) (B) | Outside Dia. (in) (C) | Depth (in) (D) | Depth (in) (E) | (in) (L) | |
| J07510SS | 5/8 | 1-1/4 | 1-5/8 | 25/64 | 15/16 | 2 | 0.70 |
| J07511SS | 11/16 | 1-11/32 | 1-5/8 | 7/16 | 15/16 | 1-7/8 | 0.75 |
| J07513SS | 13/16 | 1-5/8 | 1-5/8 | 33/64 | 1-1/16 | 2 | 0.82 |



ASME B107.2

3/4" DRIVE DEEP IMPACT SOCKET - 4 POINT

- › Drive end chamfer and four detents help provide quick positive engagement with drive tool on any of the socket drive walls.
- › Tight tolerances for snug fit on fastener.
- › Large clearance holes, concentric opening and nut end chamfer make it easy to position socket on fasteners.
- › Made from high-strength steel to help minimize wall thickness and provide access to fasteners in recesses and where nuts and bolts protrude.
- › Impact sockets are used wherever powered drive tools are used to install or remove fasteners.
- › Impact sockets are designed to withstand the high torque and force associated with impact tools in repetitive application.



| Product # | Nut End | | Drive End | Nut | Bolt Clearance | Overall Length | Weight (lbs) |
|-----------------|---------------|-----------------------|-----------------------|----------------|----------------|----------------|--------------|
| | Size (in) (A) | Outside Dia. (in) (B) | Outside Dia. (in) (C) | Depth (in) (D) | Depth (in) (E) | (in) (L) | |
| J07513SL | 13/16 | 1-5/8 | 1-5/8 | 43/64 | 3-1/16 | 4 | 1.75 |



ASME B107.2

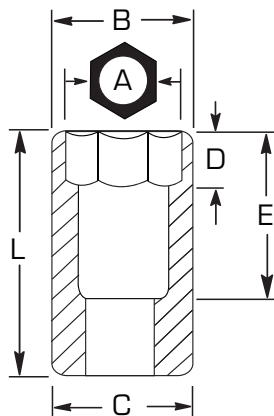

3/4" DRIVE IMPACT SOCKETS - 6 POINT

- › Proto® 6 Point Impact Sockets are ideal for use on stubborn or damaged fasteners, and also on fasteners made from soft materials.
- › TorquePlus™ features apply.
- › Stamped size for easy reference.
- › Side locking hole.



| Product # | Size (in) (A) | Nut End Outside Dia. (in) (B) | Drive End Outside Dia. (in) (C) | Nut Depth (in) (D) | Bolt Clearance Depth (in) (E) | Overall Length (in) (L) | Weight (lbs) | Crush Retaining Ring | O-Ring | Retaining Pin |
|-----------|---------------|-------------------------------|---------------------------------|--------------------|-------------------------------|-------------------------|--------------|----------------------|---------|---------------|
| J07509 | 9/16 | 1 | 1-5/8 | 23/64 | 15/16 | 1-7/8 | 0.72 | JRR07523 | J07500R | J07500P |
| J07510 | 5/8 | 1-3/32 | 1-5/8 | 25/64 | 15/16 | 1-7/8 | 0.69 | JRR07523 | J07500R | J07500P |
| J07511 | 11/16 | 1-5/32 | 1-5/8 | 7/16 | 1 | 1-15/16 | 0.72 | JRR07523 | J07500R | J07500P |
| J07512 | 3/4 | 1-15/64 | 1-5/8 | 15/32 | 1 | 1-15/16 | 0.70 | JRR07523 | J07500R | J07500P |
| J07513 | 13/16 | 1-5/16 | 1-5/8 | 1/2 | 1 | 1-15/16 | 0.67 | JRR07523 | J07500R | J07500P |
| J07514 | 7/8 | 1-1/2 | 1-5/8 | 35/64 | 1-1/16 | 2 | 0.73 | JRR07523 | J07500R | J07500P |
| J07515 | 15/16 | 1-5/8 | 1-5/8 | 37/64 | 1-1/16 | 2 | 0.78 | JRR07523 | J07500R | J07500P |
| J07516 | 1 | 1-5/8 | 1-5/8 | 5/8 | 1-1/8 | 2-1/16 | 0.73 | JRR07523 | J07500R | J07500P |
| J07517 | 1-1/16 | 1-5/8 | 1-5/8 | 21/32 | 1-1/8 | 2-1/16 | 0.81 | JRR07523 | J07500R | J07500P |
| J07518 | 1-1/8 | 1-3/4 | 1-3/4 | 45/64 | 1-1/4 | 2-3/16 | 0.91 | JRR07526 | J07500R | J07500P |
| J07519 | 1-3/16 | 1-7/8 | 1-3/4 | 47/64 | 1-1/4 | 2-3/16 | 1.02 | JRR07526 | J07500R | J07500P |
| J07520 | 1-1/4 | 2 | 1-3/4 | 3/4 | 1-1/4 | 2-3/16 | 1.10 | JRR07526 | J07500R | J07500P |
| J07521 | 1-5/16 | 2-1/8 | 1-3/4 | 27/32 | 1-1/4 | 2-3/16 | 1.19 | JRR07526 | J07500R | J07500P |
| J07522 | 1-3/8 | 2-1/8 | 1-3/4 | 13/16 | 1-3/16 | 2-1/4 | 1.18 | JRR07526 | J07500R | J07500P |
| J07523 | 1-7/16 | 2-1/4 | 1-3/4 | 7/8 | 1-3/8 | 2-5/16 | 1.29 | JRR07526 | J07500R | J07500P |
| J07524 | 1-1/2 | 2-3/8 | 1-3/4 | 1 | 1-7/16 | 2-3/8 | 1.43 | JRR07526 | J07500R | J07500P |
| J07525 | 1-9/16 | 2-3/8 | 1-3/4 | 1 | 1-1/2 | 2-7/16 | 1.57 | JRR07526 | J07500R | J07500P |
| J07526 | 1-5/8 | 2-3/8 | 1-3/4 | 1 | 1-1/2 | 2-7/16 | 1.60 | JRR07526 | J07500R | J07500P |
| J07527 | 1-11/16 | 2-39/64 | 1-3/4 | 1-1/8 | 1-11/16 | 2-5/8 | 1.78 | JRR07526 | J07500R | J07500P |
| J07528 | 1-3/4 | 2-39/64 | 1-3/4 | 1-1/8 | 1-11/16 | 2-5/8 | 1.83 | JRR07526 | J07500R | J07500P |
| J07529 | 1-13/16 | 2-3/4 | 1-3/4 | 1-1/8 | 1-11/16 | 2-5/8 | 1.92 | JRR07526 | J07500R | J07500P |
| J07530 | 1-7/8 | 2-3/4 | 1-3/4 | 1-1/4 | 1-7/8 | 2-13/16 | 2.19 | JRR07526 | J07500R | J07500P |
| J07531 | 1-15/16 | 2-7/8 | 1-3/4 | 1-1/4 | 1-7/8 | 2-13/16 | 2.28 | JRR07526 | J07500R | J07500P |
| J07532 | 2 | 3 | 1-3/4 | 1-1/4 | 1-7/8 | 2-13/16 | 2.30 | JRR07526 | J07500R | J07500P |
| J07533 | 2-1/16 | 3 | 1-3/4 | 1-3/8 | 2-5/32 | 3-3/32 | 2.66 | JRR07526 | J07500R | J07500P |
| J07534 | 2-1/8 | 3-1/8 | 1-3/4 | 1-3/8 | 2-5/32 | 3-3/32 | 2.79 | JRR07526 | J07500R | J07500P |
| J07535 | 2-3/16 | 3-1/4 | 1-3/4 | 1-3/8 | 2-3/16 | 3-1/8 | 3.25 | JRR07526 | J07500R | J07500P |
| J07536 | 2-1/4 | 3-5/16 | 1-3/4 | 1-1/2 | 2-5/16 | 3-1/4 | 3.17 | JRR07526 | J07500R | J07500P |
| J07537 | 2-5/16 | 3-9/32 | 1-3/4 | 1-1/2 | 1-15/16 | 3-5/16 | 3.21 | JRR07526 | J07500R | J07500P |
| J07538 | 2-3/8 | 3-1/2 | 1-3/4 | 1-1/2 | 2-7/16 | 3-3/8 | 3.45 | JRR07526 | J07500R | J07500P |



ASME B107.2



3/4" DRIVE METRIC IMPACT SOCKETS - 6 POINT



- › Proto® 6 Point Impact Sockets are ideal for use on stubborn or damaged fasteners, and also on fasteners made from soft materials.
- › TorquePlus™ features apply.
- › Stamped size for easy reference.
- › Side locking hole.



| Product # | Size (mm) (A) | Nut End Outside Dia. (in) (B) | Drive End Outside Dia. (in) (C) | Nut Depth (in) (D) | Bolt Clearance Depth (in) (E) | Overall Length (in) (L) | Weight (lbs) | Crush Retaining Ring | O-Ring | Retaining Pin |
|-----------|---------------|-------------------------------|---------------------------------|--------------------|-------------------------------|-------------------------|--------------|----------------------|---------|---------------|
| J07517M | 17 | 1-5/32 | 1-5/8 | 27/64 | 63/64 | 1-59/64 | 0.68 | JRR07523 | J07500R | J07500P |
| J07519M | 19 | 1-13/64 | 1-5/8 | 15/32 | 63/64 | 1-59/64 | 0.70 | JRR07523 | J07500R | J07500P |
| J07520M | 20 | 1-19/64 | 1-5/8 | 9/16 | 63/64 | 1-59/64 | 0.70 | JRR07523 | J07500R | J07500P |
| J07521M | 21 | 1-23/64 | 1-5/8 | 5/8 | 59/64 | 1-59/64 | 0.70 | JRR07523 | J07500R | J07500P |
| J07522M | 22 | 1-27/64 | 1-5/8 | 11/16 | 1-1/16 | 2 | 0.79 | JRR07523 | J07500R | J07500P |
| J07523M | 23 | 1-5/8 | 1-5/8 | 11/16 | 1-1/16 | 2 | 0.80 | JRR07523 | J07500R | J07500P |
| J07524M | 24 | 1-5/8 | 1-5/8 | 19/32 | 1-1/16 | 2 | 0.73 | JRR07523 | J07500R | J07500P |
| J07525M | 25 | 1-5/8 | 1-5/8 | 11/16 | 1-1/16 | 2 | 0.76 | JRR07523 | J07500R | J07500P |
| J07526M | 26 | 1-5/8 | 1-5/8 | 3/4 | 1-1/8 | 2-1/16 | 0.77 | JRR07523 | J07500R | J07500P |
| J07527M | 27 | 1-5/8 | 1-5/8 | 13/16 | 1-1/8 | 2-1/16 | 0.74 | JRR07523 | J07500R | J07500P |
| J07528M | 28 | 1-5/8 | 1-5/8 | 45/64 | 1-1/8 | 2-1/16 | 0.72 | JRR07523 | J07500R | J07500P |
| J07529M | 29 | 45.4 | 45.4 | 19.7 | 28.5 | 2-3/16 | 1.01 | JRR07523 | J07500R | J07500P |
| J07530M | 30 | 1-7/8 | 1-3/4 | 59/64 | 1-7/32 | 2-3/16 | 1.01 | JRR07526 | J07500R | J07500P |
| J07531M | 31 | 1-7/8 | 1-3/4 | 7/8 | 1-1/8 | 2-3/16 | 0.99 | JRR07526 | J07500R | J07500P |
| J07532M | 32 | 2 | 1-3/4 | 7/8 | 1-9/64 | 2-3/16 | 1.13 | JRR07526 | J07500R | J07500P |
| J07533M | 33 | 2 | 1-3/4 | 7/8 | 1-3/16 | 2-3/16 | 1.08 | JRR07526 | J07500R | J07500P |
| J07534M | 34 | 2-1/8 | 1-3/4 | 15/16 | 1-3/16 | 2-1/4 | 1.18 | JRR07526 | J07500R | J07500P |
| J07535M | 35 | 2-1/8 | 1-3/4 | 15/16 | 1-5/16 | 2-1/4 | 1.18 | JRR07526 | J07500R | J07500P |
| J07536M | 36 | 2-1/4 | 1-3/4 | 15/16 | 1-9/32 | 2-5/16 | 1.32 | JRR07526 | J07500R | J07500P |
| J07538M | 38 | 2-3/8 | 1-3/4 | 1 | 1-21/64 | 2-3/8 | 1.56 | JRR07526 | J07500R | J07500P |
| J07540M | 40 | 2-1/2 | 1-3/4 | 1-1/32 | 1-17/64 | 2-1/2 | 1.64 | JRR07526 | J07500R | J07500P |
| J07541M | 41 | 2-1/2 | 1-3/4 | 1-1/16 | 1-31/64 | 2-5/8 | 1.76 | JRR07526 | J07500R | J07500P |
| J07542M | 42 | 2-1/2 | 1-3/4 | 1-1/8 | 1-45/64 | 2-3/4 | 1.87 | JRR07526 | J07500R | J07500P |
| J07543M | 43 | 2-9/16 | 1-3/4 | 1-1/8 | 1-45/64 | 2-3/4 | 1.93 | JRR07526 | J07500R | J07500P |
| J07546M | 46 | 2-3/4 | 1-3/4 | 1-1/4 | 1-45/64 | 2-7/8 | 2.10 | JRR07526 | J07500R | J07500P |
| J07550M | 50 | 2-15/16 | 1-3/4 | 1-1/4 | 1-49/64 | 3-1/8 | 2.44 | JRR07526 | J07500R | J07500P |

ASME B107.33M

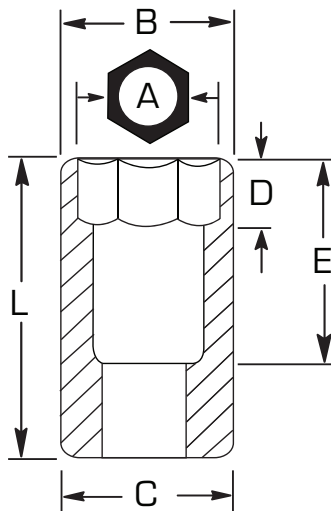

3/4" DRIVE DEEP IMPACT SOCKETS - 6 POINT

- ▶ Proto® 6 Point Impact Sockets are ideal for use on stubborn or damaged fasteners, and also on fasteners made from soft materials.
- ▶ TorquePlus™ features apply.
- ▶ Stamped size for easy reference.
- ▶ Side locking hole.



| Product # | Size (in) (A) | Nut End Outside Dia. (in) (B) | Drive End Outside Dia. (in) (C) | Nut Depth (in) (D) | Bolt Clearance Depth (in) (E) | Overall Length (in) (L) | Weight (lbs) |
|-----------|---------------|-------------------------------|---------------------------------|--------------------|-------------------------------|-------------------------|--------------|
| J07509L | 9/16 | 1 | 1-5/8 | 15/32 | 2-5/16 | 3-1/4 | 1.34 |
| J07510L | 5/8 | 1-3/32 | 1-5/8 | 33/64 | 2-5/16 | 3-1/4 | 1.28 |
| J07511L | 11/16 | 1-5/32 | 1-5/8 | 9/16 | 2-5/16 | 3-1/4 | 1.34 |
| J07512L | 3/4 | 1-1/4 | 1-5/8 | 39/64 | 2-5/16 | 3-1/4 | 1.35 |
| J07513L | 13/16 | 1-5/16 | 1-5/8 | 43/64 | 2-5/16 | 3-1/4 | 1.18 |
| J07514L | 7/8 | 1-1/2 | 1-5/8 | 23/32 | 2-5/16 | 3-1/4 | 1.23 |
| J07515L | 15/16 | 1-5/8 | 1-5/8 | 25/32 | 2-5/16 | 3-1/4 | 1.20 |
| J07516L | 1 | 1-5/8 | 1-5/8 | 53/64 | 2-5/16 | 3-1/4 | 1.11 |
| J07517L | 1-1/16 | 1-5/8 | 1-5/8 | 7/8 | 2-5/16 | 3-1/4 | 1.20 |
| J07518L | 1-1/8 | 1-3/4 | 1-3/4 | 59/64 | 2-5/16 | 3-1/4 | 1.29 |
| J07519L | 1-3/16 | 1-7/8 | 1-3/4 | 31/32 | 2-5/16 | 3-1/4 | 1.54 |
| J07520L | 1-1/4 | 2 | 1-3/4 | 1 | 2-5/16 | 3-1/4 | 1.89 |
| J07521L | 1-5/16 | 2-1/8 | 1-3/4 | 1 | 2-5/16 | 3-1/4 | 1.88 |
| J07522L | 1-3/8 | 2-1/8 | 1-3/4 | 1 | 2-5/16 | 3-1/4 | 1.79 |
| J07523L | 1-7/16 | 2-1/4 | 1-3/4 | 1-1/16 | 2-7/16 | 3-1/2 | 2.00 |
| J07524L | 1-1/2 | 2-3/8 | 1-3/4 | 1-1/16 | 2-7/16 | 3-1/2 | 2.25 |
| J07525L | 1-9/16 | 2-3/8 | 1-3/4 | 1 | 2-3/8 | 3-13/16 | 2.43 |
| J07526L | 1-5/8 | 2-3/8 | 1-3/4 | 2-1/4 | 2-5/8 | 3-13/16 | 2.57 |
| J07527L | 1-11/16 | 2-39/64 | 1-3/4 | 2-1/4 | 2-5/8 | 3-7/8 | 2.69 |
| J07528L | 1-3/4 | 2-39/64 | 1-3/4 | 2-1/4 | 2-5/8 | 3-7/8 | 2.84 |
| J07529L | 1-13/16 | 2-3/4 | 1-3/4 | 2-1/4 | 2-5/8 | 3-7/8 | 3.09 |
| J07530L | 1-7/8 | 2-3/4 | 1-3/4 | 2-3/8 | 3-3/4 | 4-1/16 | 3.19 |
| J07532L | 2 | 3 | 1-3/4 | 1-1/2 | 2-3/4 | 4-1/16 | 3.45 |



ASME B107.2

3/4" DRIVE METRIC DEEP IMPACT SOCKETS - 6 POINT

- ▶ Proto® 6 Point Impact Sockets are ideal for use on stubborn or damaged fasteners, and also on fasteners made from soft materials.
- ▶ TorquePlus™ features apply.
- ▶ Stamped size for easy reference.
- ▶ Side locking hole.



| Product # | Size (mm) (A) | Nut End Outside Dia. (in) (B) | Drive End Outside Dia. (in) (C) | Nut Depth (in) (D) | Bolt Clearance Depth (in) (E) | Overall Length (in) (L) | Weight (lbs) | Crush Retaining Ring | O-Ring | Retaining Pin |
|-----------|---------------|-------------------------------|---------------------------------|--------------------|-------------------------------|-------------------------|--------------|----------------------|---------|---------------|
| J07519ML | 19 | 1-7/32 | 1-5/8 | 5/8 | 2-1/4 | 3-1/4 | 1.32 | JRR07523 | J07500R | J07500P |
| J07521ML | 21 | 1-3/8 | 1-5/8 | 51/64 | 2-1/4 | 3-1/4 | 1.30 | JRR07523 | J07500R | J07500P |
| J07522ML | 22 | 1-7/16 | 1-5/8 | 13/16 | 2-1/4 | 3-1/4 | 1.20 | JRR07523 | J07500R | J07500P |
| J07523ML | 23 | 1-5/8 | 1-5/8 | 3/4 | 2-1/4 | 3-1/4 | 1.28 | JRR07523 | J07500R | J07500P |
| J07524ML | 24 | 1-5/8 | 1-5/8 | 13/16 | 2-1/4 | 3-1/4 | 1.31 | JRR07523 | J07500R | J07500P |
| J07526ML | 26 | 1-5/8 | 1-5/8 | 27/32 | 2-1/4 | 3-1/4 | 1.20 | JRR07523 | J07500R | J07500P |
| J07527ML | 27 | 1-5/8 | 1-5/8 | 7/8 | 2-1/4 | 3-1/4 | 1.14 | JRR07523 | J07500R | J07500P |
| J07530ML | 30 | 1-7/8 | 1-3/4 | 31/32 | 2-9/32 | 3-1/4 | 1.45 | JRR07526 | J07500R | J07500P |
| J07532ML | 32 | 2 | 1-3/4 | 1 | 2-9/32 | 3-1/4 | 1.63 | JRR07526 | J07500R | J07500P |
| J07533ML | 33 | 2 | 1-3/4 | 1 | 2-9/32 | 3-1/4 | 1.55 | JRR07526 | J07500R | J07500P |
| J07535ML | 35 | 2-1/8 | 1-3/4 | 1 | 2-9/32 | 3-1/4 | 1.89 | JRR07526 | J07500R | J07500P |
| J07536ML | 36 | 2-1/4 | 1-3/4 | 1 | 2-9/32 | 3-1/4 | 1.91 | JRR07526 | J07500R | J07500P |
| J07538ML | 38 | 2-3/8 | 1-3/4 | 1-1/16 | 2-29/64 | 3-1/2 | 2.10 | JRR07526 | J07500R | J07500P |
| J07541ML | 41 | 2-1/2 | 1-3/4 | 1-1/16 | 2-29/64 | 3-1/2 | 2.36 | JRR07526 | J07500R | J07500P |
| J07543ML | 43 | 2-9/16 | 1-3/4 | 1-1/8 | 2-29/64 | 3-1/2 | 2.52 | JRR07526 | J07500R | J07500P |



ASME B107.33M



3/4" DRIVE DEEP THIN WALL IMPACT SOCKETS - 6 POINT

- ▶ Proto® 6 Point Impact Sockets are ideal for use on stubborn or damaged fasteners, and also on fasteners made from soft materials.
- ▶ TorquePlus™ features apply.
- ▶ Stamped size for easy reference.
- ▶ Side locking hole.



| Product # | Size (in) (A) | Nut End Outside Dia. (in) (B) | Drive End Outside Dia. (in) (C) | Nut Depth (in) (D) | Bolt Clearance Depth (in) (E) | Overall Length (in) (L) | Weight (lbs) | Crush Retaining Ring | O-Ring | Retaining Pin |
|-----------|---------------|-------------------------------|---------------------------------|--------------------|-------------------------------|-------------------------|--------------|----------------------|---------|---------------|
| J07512-LT | 3/4 | 1-3/8 | 1-3/8 | 39/64 | 3-1/16 | 4 | 1.04 | JRR07523 | J07500R | J07500P |
| J07513-LT | 13/16 | 1-3/8 | 1-3/8 | 21/32 | 3-1/16 | 4 | 1.02 | JRR07523 | J07500R | J07500P |
| J07514-LT | 7/8 | 1-3/8 | 1-3/8 | 23/32 | 3-1/16 | 4 | 1.01 | JRR07523 | J07500R | J07500P |
| J07515-LT | 15/16 | 1-3/8 | 1-3/8 | 49/64 | 3-1/16 | 4 | 0.80 | JRR07523 | J07500R | J07500P |
| J07516-LT | 1 | 1-7/16 | 1-7/16 | 53/64 | 3-1/16 | 4 | 1.06 | JRR07523 | J07500R | J07500P |
| J07517-LT | 1-1/16 | 1-1/2 | 1-1/2 | 7/8 | 3-1/16 | 4 | 0.96 | JRR07523 | J07500R | J07500P |
| J07518-LT | 1-1/8 | 1-5/8 | 1-5/8 | 59/64 | 3-1/16 | 4 | 1.19 | JRR07526 | J07500R | J07500P |
| J07519-LT | 1-3/16 | 1-11/16 | 1-11/16 | 31/32 | 3-1/16 | 4 | 1.24 | JRR07526 | J07500R | J07500P |
| J07520-LT | 1-1/4 | 1-3/4 | 1-3/4 | 1 | 3-1/16 | 4 | 1.33 | JRR07526 | J07500R | J07500P |
| J07521-LT | 1-5/16 | 1-7/8 | 1-3/4 | 1-1/8 | 2-5/16 | 3-1/4 | 1.28 | JRR07526 | J07500R | J07500P |
| J07522-LT | 1-3/8 | 1-15/16 | 1-3/4 | 1-1/8 | 2-5/16 | 3-1/4 | 1.32 | JRR07526 | J07500R | J07500P |
| J07523-LT | 1-7/16 | 2 | 1-3/4 | 1-1/8 | 2-9/16 | 3-1/2 | 1.42 | JRR07526 | J07500R | J07500P |
| J07524-LT | 1-1/2 | 2-1/8 | 1-3/4 | 1-1/4 | 2-9/16 | 3-1/2 | 1.86 | JRR07526 | J07500R | J07500P |



ASME B107.2

3/4" DRIVE IMPACT SOCKETS - 8 POINT

- ▶ Proto® 8 Point Impact Sockets are ideal for use on stubborn or damaged fasteners, and also on fasteners made from soft materials.
- ▶ TorquePlus™ features apply.
- ▶ Drive end chamfer and four detents help provide quick positive engagement with drive tool on any of the socket drive walls.
- ▶ Tight tolerances for snug fit on fastener.
- ▶ Large clearance holes, concentric opening and nut end chamfer make it easy to position socket on fasteners.
- ▶ Made from high-strength steel to help minimize wall thickness and provide access to fasteners in recesses and where nuts and bolts protrude.
- ▶ Impact sockets are designed to withstand higher torque and force associated with impact tools in repetitive application.
- ▶ Features two through holes and a groove to accept a Proto® Retaining Ring or pin and O-ring to help secure the socket to the drive tool anvil.
- ▶ Stamped size for easy reference.
- ▶ Side locking hole.



| Product # | Size (in) (A) | Nut End Outside Dia. (in) (B) | Drive End Outside Dia. (in) (C) | Nut Depth (in) (D) | Bolt Clearance Depth (in) (E) | Overall Length (in) (L) | Weight (lbs) | Crush Retaining Ring | O-Ring | Retaining Pin |
|-----------|---------------|-------------------------------|---------------------------------|--------------------|-------------------------------|-------------------------|--------------|----------------------|---------|---------------|
| J07512S | 3/4 | 1-5/8 | 1-5/8 | 15/37 | 31/32 | 1-15/16 | 0.81 | JRR07523 | J07500R | J07500P |
| J07513S | 13/16 | 1-5/8 | 1-5/8 | 1/2 | 1-1/32 | 2 | 0.82 | JRR07523 | J07500R | J07500P |
| J07514S | 7/8 | 1-3/4 | 1-3/4 | 35/64 | 1-1/32 | 2 | 0.97 | JRR07523 | J07500R | J07500P |
| J07515S | 15/16 | 1-13/16 | 1-3/4 | 19/32 | 1-3/32 | 2-1/16 | 1.07 | JRR07523 | J07500R | J07500P |
| J07516S | 1 | 2 | 1-3/4 | 5/8 | 1-5/32 | 2-1/8 | 1.23 | JRR07523 | J07500R | J07500P |
| J07517S | 1-1/16 | 2-1/8 | 1-3/4 | 21/32 | 1-7/32 | 2-3/16 | 1.28 | JRR07523 | J07500R | J07500P |
| J07518S | 1-1/8 | 2-1/4 | 1-3/4 | 45/64 | 1-15/64 | 2-1/4 | 1.42 | JRR07526 | J07500R | J07500P |
| J07519S | 1-3/16 | 2-3/8 | 1-3/4 | 3/4 | 1-11/32 | 2-5/16 | 1.55 | JRR07526 | J07500R | J07500P |
| J07520S | 1-1/4 | 2-3/8 | 1-3/4 | 3/4 | 1-13/32 | 2-3/8 | 1.57 | JRR07526 | J07500R | J07500P |
| J07521S | 1-5/16 | 2-1/2 | 1-3/4 | 7/8 | 1-13/32 | 2-3/8 | 1.75 | JRR07526 | J07500R | J07500P |



ASME B107.2



3/4" DRIVE IMPACT SOCKETS - 12 POINT

- ▶ Proto® 12 Point Impact Sockets are ideal for use on stubborn or damaged fasteners, and also on fasteners made from soft materials.
- ▶ TorquePlus™ features apply.
- ▶ Stamped size for easy reference.
- ▶ Side locking hole.



| Product # | Size (in) (A) | Nut End | Drive End | Nut | Bolt Clearance Depth (in) (E) | Overall Length (in) (L) | Weight (lbs) | Crush | | Retaining Pin |
|-----------|---------------|-----------------------|-----------------------|----------------|-------------------------------|-------------------------|--------------|----------------|---------|---------------|
| | | Outside Dia. (in) (B) | Outside Dia. (in) (C) | Depth (in) (D) | | | | Retaining Ring | O-Ring | |
| J07509T | 9/16 | 1 | 1-5/8 | 23/64 | 17/32 | 1-7/8 | 0.70 | JRR07523 | J07500R | J07500P |
| J07510T | 5/8 | 1-3/32 | 1-5/8 | 25/64 | 9/16 | 1-7/8 | 0.70 | JRR07523 | J07500R | J07500P |
| J07511T | 11/16 | 1-5/32 | 1-5/8 | 7/16 | 5/8 | 1-15/16 | 0.75 | JRR07523 | J07500R | J07500P |
| J07512T | 3/4 | 1-1/4 | 1-5/8 | 15/32 | 11/16 | 1-15/16 | 0.75 | JRR07523 | J07500R | J07500P |
| J07513T | 13/16 | 1-5/16 | 1-5/8 | 1/2 | 3/4 | 1-15/16 | 0.78 | JRR07523 | J07500R | J07500P |
| J07514T | 7/8 | 1-1/2 | 1-5/8 | 9/16 | 13/16 | 2 | 0.79 | JRR07523 | J07500R | J07500P |
| J07515T | 15/16 | 1-5/8 | 1-5/8 | 37/64 | 7/8 | 2 | 0.76 | JRR07523 | J07500R | J07500P |
| J07516T | 1 | 1-5/8 | 1-5/8 | 5/8 | 15/16 | 2 | 0.76 | JRR07523 | J07500R | J07500P |
| J07517T | 1-1/16 | 1-5/8 | 1-5/8 | 21/32 | 1 | 2-1/16 | 0.80 | JRR07523 | J07500R | J07500P |
| J07518T | 1-1/8 | 1-3/4 | 1-3/4 | 29/32 | 29/32 | 2-3/16 | 0.88 | JRR07526 | J07500R | J07500P |
| J07519T | 1-3/16 | 1-7/8 | 1-3/4 | 63/64 | 1-3/32 | 2-3/16 | 1.01 | JRR07526 | J07500R | J07500P |
| J07520T | 1-1/4 | 2 | 1-3/4 | 1 | 1-1/8 | 2-3/16 | 1.11 | JRR07526 | J07500R | J07500P |
| J07521T | 1-5/16 | 2-1/8 | 1-3/4 | 17/64 | 1-3/32 | 2-3/16 | 1.18 | JRR07526 | J07500R | J07500P |
| J07522T | 1-3/8 | 2-1/8 | 1-3/4 | 1-1/8 | 1-1/8 | 2-1/4 | 1.21 | JRR07526 | J07500R | J07500P |
| J07523T | 1-7/16 | 2-1/4 | 1-3/4 | 1-1/8 | 1-1/8 | 2-5/16 | 1.34 | JRR07526 | J07500R | J07500P |
| J07524T | 1-1/2 | 2-3/8 | 1-3/4 | 1-3/16 | 1-3/16 | 2-3/8 | 1.35 | JRR07526 | J07500R | J07500P |
| J07525T | 1-9/16 | 2-3/8 | 1-3/4 | 1-1/4 | 1-1/4 | 2-7/16 | 1.52 | JRR07526 | J07500R | J07500P |
| J07526T | 1-5/8 | 2-3/8 | 1-3/4 | 11/4 | 1-1/4 | 2-7/16 | 1.47 | JRR07526 | J07500R | J07500P |
| J07527T | 1-11/16 | 2-39/64 | 1-3/4 | 1-13/32 | 1-13/32 | 2-5/8 | 1.65 | JRR07526 | J07500R | J07500P |
| J07528T | 1-3/4 | 2-39/64 | 1-3/4 | 1-13/32 | 1-13/32 | 2-5/8 | 1.80 | JRR07526 | J07500R | J07500P |
| J07529T | 1-13/16 | 2-3/4 | 1-3/4 | 1-13/32 | 1-13/32 | 2-5/8 | 2.01 | JRR07526 | J07500R | J07500P |
| J07530T | 1-7/8 | 2-3/4 | 1-3/4 | 1-1/2 | 1-1/2 | 2-13/16 | 2.02 | JRR07526 | J07500R | J07500P |
| J07531T | 1-15/16 | 2-7/8 | 1-3/4 | 1-1/2 | 1-1/2 | 2-13/16 | 2.23 | JRR07526 | J07500R | J07500P |
| J07532T | 2 | 3 | 1-3/4 | 1-1/2 | 1-1/2 | 2-13/16 | 2.33 | JRR07526 | J07500R | J07500P |
| J07533T | 2-1/16 | 3 | 1-3/4 | 1-9/16 | 1-9/16 | 3-3/32 | 2.73 | JRR07526 | J07500R | J07500P |
| J07534T | 2-1/8 | 3-1/8 | 1-3/4 | 1-9/16 | 1-9/16 | 3-3/32 | 2.96 | JRR07526 | J07500R | J07500P |
| J07535T | 2-3/16 | 3-1/4 | 1-3/4 | 1-9/16 | 1-9/16 | 3-1/8 | 2.87 | JRR07526 | J07500R | J07500P |
| J07536T | 2-1/4 | 3-1/4 | 1-3/4 | 1-21/32 | 1-21/32 | 3-1/4 | 3.13 | JRR07526 | J07500R | J07500P |
| J07538T | 2-3/8 | 3-1/2 | 1-3/4 | 1-3/4 | 1-3/4 | 3-3/8 | 4.11 | JRR07526 | J07500R | J07500P |



AS954E S3.8.1

ASME B107.2

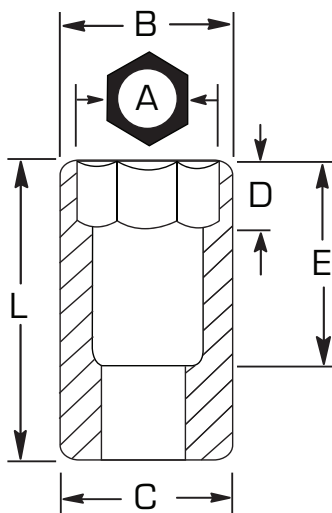

3/4" DRIVE IMPACT HEX BIT SOCKETS

- › Stamped size for easy reference.
- › Side locking hole.



| Product # | Size (in) | Bit Length (in) | Overall Length (in) | Weight (lbs) | Repair Kit |
|------------|-----------|-----------------|---------------------|--------------|--------------|
| J075909/16 | 9/16 | 1-3/8 | 3-3/4 | 0.96 | J075909/16RK |
| J075905/8 | 5/8 | 1-15/32 | 3-27/32 | 1.11 | J075905/8RK |
| J075903/4 | 3/4 | 1-7/8 | 4-3/8 | 1.75 | J075903/4RK |
| J075907/8 | 7/8 | 2-7/32 | 4-3/4 | 2.09 | J075907/8RK |
| J075901 | 1 | 2-33/64 | 5-13/64 | 2.59 | J05901RK |



3/4" DRIVE HEX BIT REPAIR KITS

| Product # | Size (in) | Weight (lbs) | Hex Bit |
|--------------|-----------|--------------|------------|
| J075909/16RK | 9/16 | 0.18 | J075909/16 |
| J075905/8RK | 5/8 | 0.21 | J075905/8 |
| J075903/4RK | 3/4 | 0.41 | J075903/4 |
| J075907/8RK | 7/8 | 0.62 | J075907/8 |
| J075901RK | 1 | 0.94 | J075901 |



3/4" DRIVE IMPACT UNIVERSAL JOINT

- › Tight tolerances for snug fit on fastener.
- › Used wherever powered drive tools are used to install or remove fasteners.
- › Designed to withstand the high torque and force associated with impact tools in repetitive application.
- › Features two through holes and a groove to accept a Proto® Retaining Ring or pin and O-ring to help secure the socket to the drive tool anvil.
- › Position at appropriate angle to turn fasteners where obstructions prevent a straight application.
- › Ball and spring design which allows for a 30° working angle.
- › Smooth 360° rotation.



| Product # | Overall Length (in) (L) | Weight (lbs) |
|-----------|-------------------------|--------------|
| J07570A | 3-1/2 | 1.40 |





3/4" DRIVE ADAPTERS

- › Use adapters to help increase or decrease drive end size.
- › Do not use hand adapters with power tools.
- › Do not over torque small sockets when using them with adapters on large drive tools.
- › Made of forged steel.
- › Size stamped on tool for easy identification.

| Product # | Size (in) | Overall Length (in) (L) | Weight (lbs) |
|---------------|---------------|-------------------------|--------------|
| J07655 | 3/4" F x 1" M | 2-1/2 | 0.89 |
| J07656 | 1"F x 3/4"M | 2-7/8 | 1.42 |
| J7656 | 5/8"F x 3/4"M | 1-31/32 | 0.40 |

 ASME B107.2



3/4" DRIVE BUDD WHEEL DEEP SOCKET

- › Stamped size for easy reference.
- › Side locking hole.

| Product # | Size (in) (A) | Nut End Outside Dia. (in) (B) | Drive End Outside Dia. (in) (C) | Overall Length (in) (L) | Weight (lbs) |
|------------------|---------------|-------------------------------|---------------------------------|-------------------------|--------------|
| J07524-LS | 1-1/2 | 2-1/4 | 1-5/8 | 4 | 3.12 |



3/4" DRIVE EXTENSIONS

- › Use extensions to gain access to fasteners in locations that would otherwise be difficult to reach.
- › Male square is oriented in-line with female squares for use with fixed head torque wrenches.
- › Full chamfer at drive opening (when applicable) for easy engagement with drive tools.
- › Drive end chamfer and four detents help provide quick positive engagement with drive tool on any of the socket drive walls.
- › Features two thru holes and a groove to accept a Proto® retaining ring or pin or O-ring to help secure extension to the drive tool anvil.

| Product # | Overall Length (in) (L) | Weight (lbs) |
|---------------|-------------------------|--------------|
| J07565 | 5 | 1.48 |
| J07567 | 7 | 1.97 |
| J07568 | 10 | 2.73 |
| J07569 | 13 | 3.12 |

 ASME B107.2





3/4" DRIVE RETAINING RINGS

- › Retaining rings are used to help secure sockets onto drive tools.
- › They are not intended to bear any load.
- › The rotational forces are between the drive tool and the socket.
- › The resin crush gauge on the pin helps indicate when a socket is excessively worn and should be replaced.
- › Drive tool and socket should line up when in use and should not pinch the crush gauge.
- › Cracked sockets and or worn drive tools cause each other to turn excessively in relation to each other. This action pinches the small fin or the crush gauge on these retaining rings. If the crush gauge is pinched, it is an indication that the socket and or the drive tool need to be replaced.
- › One-piece construction, no loose parts. Pin is made of resin which allows the material to compress without breaking.
- › Part numbers are embossed on the rings near the point at which the pin and ring meet.



| Product # | Description | For Groove Dia. (in) | Diameter (in) | Height (in) | Weight (lbs) |
|-----------|--------------------------------------|----------------------|---------------|-------------|--------------|
| JRR07520 | Retaining Ring, 3/4" DR 1-1/4" GRV | 1-1/4 | 1-7/16 | 3/16 | 0.01 |
| JRR07523 | Retaining Ring, 3/4" DR 1-7/16" GRV | 1-7/16 | 1-5/8 | 3/16 | 0.01 |
| JRR07526 | Retaining Ring, 3/4" DR 1-5/8" GRV | 1-5/8 | 1-13/16 | 3/16 | 0.01 |
| JRR07528 | Retaining Ring, 3/4" DR 1-3/4" GRV | 1-3/4 | 1-15/16 | 3/16 | 0.01 |
| JRR07532 | Retaining Ring, 3/4" DR 1-15/16" GRV | 1-15/16 | 2-3/16 | 3/16 | 0.01 |
| JRR07534 | Retaining Ring, 3/4" DR 2-1/8" GRV | 2-1/8 | 2-5/16 | 3/16 | 0.01 |
| JRR07536 | Retaining Ring, 3/4" DR 2-1/4" GRV | 2-1/4 | 2-7/16 | 3/16 | 0.01 |



3/4" DRIVE IMPACT SOCKET O-RING

| Product # | Drive Size (in) | For Use With | Weight (lbs) |
|-----------|-----------------|---|--------------|
| J07500R | 3/4 | All 3/4" drive impact sockets and attachments | 0.01 |



3/4" DRIVE IMPACT SOCKET RETAINING PIN

| Product # | Drive Size (in) | For Use With | Weight (lbs) |
|-----------|-----------------|---|--------------|
| J07500P | 3/4 | All 3/4" drive impact sockets and attachments | 0.01 |



1" DRIVE IMPACT SOCKETS - 4 POINT

- ▶ Drive end chamfer and four detents help provide quick positive engagement with drive tool on any of the socket drive walls.
- ▶ Tight tolerances for snug fit on fastener.
- ▶ Large clearance holes, concentric opening and nut end chamfer make it easy to position socket on fasteners.
- ▶ Made from high-strength steel to help minimize wall thickness and provide access to fasteners in recesses and where nuts and bolts protrude.
- ▶ Impact sockets are used wherever powered drive tools are used to install or remove fasteners.
- ▶ Impact sockets are designed to withstand the high torque and force associated with impact tools in repetitive application.
- ▶ Features two through holes and a groove to accept a Proto® Retaining Ring or pin and O-ring to help secure the socket to the drive tool anvil.



| Product # | Nut End Outside Dia. (in) (A) | Drive End Outside Dia. (in) (B) | Nut Depth (in) (C) | Bolt Clearance Depth (in) (D) | Overall Length (in) (E) | Weight (lbs) | Crush Retaining Ring | O-Ring | Retaining Pin | |
|-----------|-------------------------------|---------------------------------|--------------------|-------------------------------|-------------------------|--------------|----------------------|----------|---------------|----------|
| J10012SS | 3/4 | 1-7/8 | 2-1/8 | 5/8 | 1-3/8 | 2-1/2 | 1.57 | JRR10028 | J10000R1 | J10000P1 |
| J10013SS | 13/16 | 1-15/16 | 2-1/8 | 5/8 | 1-3/8 | 2-1/2 | 1.53 | JRR10028 | J10000R1 | J10000P1 |
| J10014SS | 7/8 | 2 | 2-1/8 | 5/8 | 1-3/8 | 2-1/2 | 1.52 | JRR10028 | J10000R1 | J10000P1 |
| J10015SS | 15/16 | 2-1/16 | 2-1/8 | 19/32 | 1-3/8 | 2-1/2 | 1.80 | JRR10028 | J10000R1 | J10000P1 |
| J10016SS | 1 | 2-1/8 | 2-1/8 | 11/16 | 1-3/8 | 2-1/2 | 1.75 | JRR10028 | J10000R1 | J10000P1 |
| J10018SS | 1-1/8 | 2-1/4 | 2-3/8 | 23/32 | 1-3/8 | 2-1/2 | 1.80 | JRR10028 | J10000R1 | J10000P1 |
| J10024SS | 1-1/2 | 2-5/8 | 2-5/8 | 25/32 | 1-3/8 | 2-1/2 | 2.80 | JRR10028 | J10000R1 | J10000P1 |



1" DRIVE IMPACT SOCKETS - 8 POINT

- ▶ Drive end chamfer and four detents help provide quick positive engagement with drive tool on any of the socket drive walls.
- ▶ Tight tolerances for snug fit on fastener.
- ▶ Large clearance holes, concentric opening and nut end chamfer make it easy to position socket on fasteners.
- ▶ Made from high-strength steel to help minimize wall thickness and provide access to fasteners in recesses and where nuts and bolts protrude.
- ▶ Impact sockets are used wherever powered drive tools are used to install or remove fasteners.
- ▶ Impact sockets are designed to withstand the high torque and force associated with impact tools in repetitive application.
- ▶ Features two through holes and a groove to accept a Proto® Retaining Ring or pin and O-ring to help secure the socket to the drive tool anvil.



| Product # | Nut End Outside Dia. (in) (A) | Drive End Outside Dia. (in) (B) | Nut Depth (in) (C) | Bolt Clearance Depth (in) (D) | Overall Length (in) (E) | Weight (lbs) | Crush Retaining Ring | O-Ring | Retaining Pin | |
|-----------|-------------------------------|---------------------------------|--------------------|-------------------------------|-------------------------|--------------|----------------------|----------|---------------|----------|
| J10014S | 7/8 | 2 | 2 | 5/8 | 1-3/8 | 2-5/8 | 1.33 | JRR10028 | J10000R1 | J10000P1 |
| J10015S | 15/16 | 2 | 2 | 5/8 | 1-3/8 | 2-5/8 | 1.52 | JRR10028 | J10000R1 | J10000P1 |
| J10016S | 1 | 2-3/32 | 2-3/32 | 11/16 | 1-3/8 | 2-13/16 | 1.61 | JRR10028 | J10000R1 | J10000P1 |
| J10018S | 1-1/8 | 2-7/16 | 2-7/16 | 23/32 | 1-3/8 | 2-13/16 | 1.85 | JRR10028 | J10000R1 | J10000P1 |
| J10019S | 1-3/16 | 2-1/4 | 2-3/32 | 23/32 | 1-3/8 | 2-11/16 | 1.74 | JRR10028 | J10000R1 | J10000P1 |
| J10020S | 1-1/4 | 2-7/16 | 2-7/16 | 11/16 | 1-1/2 | 2-13/16 | 1.92 | JRR10028 | J10000R1 | J10000P1 |
| J10021S | 1-5/16 | 2-1/2 | 2-1/2 | 25/32 | 1-1/2 | 2-13/16 | 2.07 | JRR10028 | J10000R1 | J10000P1 |
| J10022S | 1-3/8 | 2-1/2 | 2-1/2 | 25/32 | 1-5/8 | 2-13/16 | 1.97 | JRR10028 | J10000R1 | J10000P1 |
| J10023S | 1-7/16 | 2-13/16 | 2-13/16 | 13/16 | 1-5/8 | 2-15/16 | 2.54 | JRR10028 | J10000R1 | J10000P1 |
| J10024S | 1-1/2 | 2-13/16 | 2-13/16 | 13/16 | 1-5/8 | 2-13/16 | 2.47 | JRR10028 | J10000R1 | J10000P1 |
| J10026S | 1-5/8 | 3-3/32 | 3-3/32 | 13/16 | 1-5/8 | 3-1/2 | 3.81 | JRR10032 | J10000R2 | J10000P2 |
| J10027S | 1-11/16 | 3-3/16 | 3-3/16 | 7/8 | 1-3/4 | 3-1/2 | 4.06 | JRR10032 | J10000R2 | J10000P2 |
| J10028S | 1-3/4 | 3-3/16 | 3-3/16 | 7/8 | 1-3/4 | 3-1/2 | 4.29 | JRR10034 | J10000R2 | J10000P2 |
| J10029S | 1-13/16 | 3-3/8 | 3-3/8 | 7/8 | 1-7/8 | 3-1/2 | 4.16 | JRR10034 | J10000R2 | J10000P2 |
| J10030S | 1-7/8 | 3-13/32 | 3-13/32 | 15/16 | 1-7/8 | 3-1/2 | 4.17 | JRR10034 | J10000R2 | J10000P2 |
| J10032S | 2 | 3-1/2 | 3-1/2 | 1 | 1-15/16 | 3-1/2 | 4.42 | JRR10034 | J10000R2 | J10000P2 |
| J10035S | 2-3/16 | 3-7/8 | 3-7/8 | 1 | 1-15/16 | 3-1/2 | 5.28 | JRR10034 | J10000R2 | J10000P2 |





1" DRIVE IMPACT SOCKETS - 6 POINT

- ▶ Proto® 6 Point Impact Sockets are ideal for use on stubborn or damaged fasteners, and also on fasteners made from soft materials.
- ▶ TorquePlus™ features apply.



| Product # | Size (in) (A) | Nut End Outside Dia. (in) (B) | Drive End Outside Dia. (in) (C) | Nut Depth (in) (D) | Bolt Clearance Depth (in) (E) | Overall Length (in) (L) | Weight (lbs) | Crush Retaining Ring | O-Ring | Retaining Pin |
|-----------|---------------|-------------------------------|---------------------------------|--------------------|-------------------------------|-------------------------|--------------|----------------------|----------|---------------|
| J10012 | 3/4 | 1-7/16 | 2-1/8 | 19/32 | 1-5/16 | 2-7/16 | 1.11 | JRR10028 | J10000R1 | J10000P1 |
| J10013 | 13/16 | 1-1/2 | 2-1/8 | 5/8 | 1-3/8 | 2-1/2 | 1.07 | JRR10028 | J10000R1 | J10000P1 |
| J10014 | 7/8 | 1-17/32 | 2-1/8 | 21/32 | 1-3/8 | 2-1/2 | 1.17 | JRR10028 | J10000R1 | J10000P1 |
| J10015 | 15/16 | 1-39/64 | 2-1/8 | 19/32 | 1-3/8 | 2-1/2 | 1.19 | JRR10028 | J10000R1 | J10000P1 |
| J10016 | 1 | 1-3/4 | 2-1/8 | 3/4 | 1-3/8 | 2-1/2 | 1.19 | JRR10028 | J10000R1 | J10000P1 |
| J10017 | 1-1/16 | 1-3/4 | 2-1/8 | 7/8 | 1-1/2 | 2-5/8 | 1.28 | JRR10028 | J10000R1 | J10000P1 |
| J10018 | 1-1/8 | 1-13/16 | 2-1/8 | 7/8 | 1-1/2 | 2-5/8 | 1.27 | JRR10028 | J10000R1 | J10000P1 |
| J10019 | 1-3/16 | 1-7/8 | 2-1/8 | 7/8 | 1-1/2 | 2-5/8 | 1.50 | JRR10028 | J10000R1 | J10000P1 |
| J10020 | 1-1/4 | 2-1/8 | 2-1/8 | 15/16 | 1-1/2 | 2-5/8 | 1.50 | JRR10028 | J10000R1 | J10000P1 |
| J10021 | 1-5/16 | 2-1/8 | 2-1/8 | 15/16 | 1-5/8 | 2-3/4 | 1.45 | JRR10028 | J10000R1 | J10000P1 |
| J10022 | 1-3/8 | 2-1/8 | 2-1/8 | 1-1/32 | 1-5/8 | 2-3/4 | 1.65 | JRR10028 | J10000R1 | J10000P1 |
| J10023 | 1-7/16 | 2-1/8 | 2-1/8 | 1-1/32 | 1-5/16 | 2-7/16 | 1.71 | JRR10028 | J10000R1 | J10000P1 |
| J10024 | 1-1/2 | 2-3/8 | 2-3/8 | 1-1/4 | 1-1/2 | 2-5/8 | 1.89 | JRR10028 | J10000R1 | J10000P1 |
| J10025 | 1-9/16 | 2-3/8 | 2-3/8 | 1-1/4 | 1-1/2 | 2-5/8 | 2.14 | JRR10032 | J10000R2 | J10000P2 |
| J10026 | 1-5/8 | 2-15/32 | 2-3/8 | 1-1/4 | 1-1/2 | 2-5/8 | 2.11 | JRR10032 | J10000R2 | J10000P2 |
| J10027 | 1-11/16 | 2-39/64 | 2-3/8 | 1-1/8 | 1-11/16 | 2-13/16 | 2.18 | JRR10032 | J10000R2 | J10000P2 |
| J10028 | 1-3/4 | 2-11/16 | 2-3/8 | 1-1/8 | 1-11/16 | 2-13/16 | 2.63 | JRR10034 | J10000R2 | J10000P2 |
| J10029 | 1-13/16 | 2-51/64 | 2-3/8 | 1-1/8 | 1-1/16 | 2-13/16 | 2.55 | JRR10034 | J10000R2 | J10000P2 |
| J10030 | 1-7/8 | 2-51/64 | 2-3/8 | 1-1/4 | 1-7/8 | 3 | 2.75 | JRR10034 | J10000R2 | J10000P2 |
| J10031 | 1-15/16 | 2-7/8 | 2-3/8 | 1-1/4 | 1-7/8 | 3 | 3.01 | JRR10034 | J10000R2 | J10000P2 |
| J10032 | 2 | 3 | 2-3/8 | 1-1/4 | 1-7/8 | 3 | 3.10 | JRR10034 | J10000R2 | J10000P2 |
| J10033 | 2-1/16 | 3 | 2-3/8 | 1-9/16 | 1-9/16 | 3-3/32 | 3.04 | JRR10034 | J10000R2 | J10000P2 |
| J10034 | 2-1/8 | 3-1/8 | 2-3/8 | 1-3/8 | 1-9/16 | 3-3/32 | 3.30 | JRR10034 | J10000R2 | J10000P2 |
| J10035 | 2-3/16 | 3-1/4 | 2-3/8 | 1-3/8 | 1-9/16 | 3-1/8 | 3.54 | JRR10034 | J10000R2 | J10000P2 |
| J10036 | 2-1/4 | 3-5/16 | 2-3/8 | 1-1/2 | 1-21/32 | 3-1/4 | 3.60 | JRR10034 | J10000R2 | J10000P2 |
| J10037 | 2-5/16 | 3-7/16 | 2-3/8 | 1-1/2 | 1-23/32 | 3-21/64 | 4.13 | JRR10034 | J10000R2 | J10000P2 |
| J10038 | 2-3/8 | 3-1/2 | 2-3/8 | 1-1/2 | 1-3/4 | 3-3/8 | 4.07 | JRR10034 | J10000R2 | J10000P2 |
| J10039 | 2-7/16 | 3-1/2 | 2-3/8 | 1-5/8 | 1-3/4 | 3-25/64 | 4.12 | JRR10034 | J10000R2 | J10000P2 |
| J10040 | 2-1/2 | 3-5/8 | 2-3/8 | 1-5/8 | 1-13/16 | 3-1/2 | 4.15 | JRR10034 | J10000R2 | J10000P2 |
| J10041 | 2-9/16 | 3-47/64 | 2-3/8 | 1-5/8 | 1-13/16 | 3-1/2 | 4.94 | JRR10040 | - | - |
| J10042 | 2-5/8 | 3-3/4 | 2-3/8 | 1-3/4 | 1-15/16 | 3-5/8 | 4.92 | JRR10040 | - | - |
| J10043 | 2-11/16 | 3-7/8 | 2-3/8 | 1-3/4 | 1-15/16 | 3-21/32 | 5.39 | JRR10040 | - | - |
| J10044 | 2-3/4 | 3-7/8 | 2-3/8 | 1-3/4 | 2 | 3-3/4 | 5.39 | JRR10040 | - | - |
| J10045 | 2-13/16 | 4 | 2-3/8 | 1-7/8 | 2-3/64 | 3-13/16 | 5.99 | JRR10040 | - | - |
| J10046 | 2-7/8 | 4-1/16 | 2-3/8 | 1-7/8 | 2-5/64 | 3-7/8 | 5.95 | JRR10040 | - | - |
| J10047 | 2-15/16 | 4-1/8 | 2-3/8 | 1-7/8 | 2-1/16 | 3-7/8 | 6.11 | JRR10040 | - | - |
| J10048 | 3 | 4-1/4 | 2-3/8 | 2 | 2-3/16 | 4 | 6.77 | JRR10040 | - | - |
| J10050 | 3-1/8 | 4-3/8 | 2-3/8 | 2 | 2-3/16 | 4-1/16 | 6.94 | JRR10040 | - | - |
| J10052 | 3-1/4 | 4-1/2 | 2-3/8 | 2 | 2-15/32 | 4-3/8 | 7.62 | JRR10040 | - | - |
| J10054 | 3-3/8 | 4-9/16 | 2-3/8 | 2-1/4 | 2-15/32 | 4-7/16 | 7.80 | JRR10040 | - | - |
| J10056 | 3-1/2 | 4-3/4 | 2-3/8 | 2-1/4 | 2-1/2 | 4-1/2 | 8.45 | JRR10040 | - | - |
| J10058 | 3-5/8 | 4-7/8 | 2-3/8 | 2-1/4 | 2-35/64 | 4-3/4 | 10.59 | - | - | - |
| J10062 | 3-7/8 | 5-1/16 | 2-3/8 | 2-1/4 | 2-31/32 | 5 | 12.20 | - | - | - |
| J10064 | 4 | 5-3/4 | 2-3/8 | 2-1/2 | 4-3/8 | 5-1/2 | 14.89 | - | - | - |
| J10066 | 4-1/8 | 6 | 2-3/8 | 2-3/4 | 4-5/8 | 5-1/2 | 15.26 | - | - | - |
| J10068 | 4-1/4 | 6 | 2-3/8 | 2-3/4 | 4-5/8 | 5-1/2 | 15.56 | - | - | - |
| J10072 | 4-1/2 | 6-1/4 | 2-3/8 | 3 | 4-7/8 | 6 | 17.61 | - | - | - |



ASME B107.2



1" DRIVE METRIC IMPACT SOCKETS - 6 POINT



- › Proto® 6 Point Impact Sockets are ideal for use on stubborn or damaged fasteners, and also on fasteners made from soft materials.
- › TorquePlus™ features apply.



| Product # | Size (mm) (A) | Nut End Outside Dia. (in) (B) | Drive End Outside Dia. (in) (C) | Nut Depth (in) (D) | Bolt Clearance Depth (in) (E) | Overall Length (in) (L) | Weight (lbs) | Crush Retaining Ring | O-Ring | Retaining Pin |
|-----------|---------------|-------------------------------|---------------------------------|--------------------|-------------------------------|-------------------------|--------------|----------------------|----------|---------------|
| J10019M | 19 | 1-7/16 | 2-1/8 | 39/64 | 57/64 | 2-13/32 | 1.10 | JRR10028 | J10000R1 | J10000P1 |
| J10022M | 22 | 1-35/64 | 2-1/8 | 21/32 | 1 | 2-13/32 | 1.09 | JRR10028 | J10000R1 | J10000P1 |
| J10024M | 24 | 1-39/64 | 2-1/8 | 3/4 | 1 | 2-13/32 | 1.06 | JRR10028 | J10000R1 | J10000P1 |
| J10026M | 26 | 1-45/64 | 2 | 1-1/8 | 1-1/2 | 2-3/8 | 1.16 | JRR10032 | J10000R2 | J10000P2 |
| J10027M | 27 | 1-49/64 | 2-1/8 | 7/8 | 1-13/64 | 2-19/32 | 1.27 | JRR10032 | J10000R2 | J10000P2 |
| J10028M | 28 | 1-13/16 | 2-1/8 | 7/8 | 1-13/64 | 2-19/32 | 1.27 | JRR10034 | J10000R2 | J10000P2 |
| J10029M | 29 | 1-51/64 | 2-1/8 | 1-19/64 | 1-31/64 | 2-19/32 | 1.30 | JRR10034 | J10000R2 | J10000P2 |
| J10030M | 30 | 1-7/8 | 2-1/8 | 7/8 | 1-13/64 | 2-19/32 | 1.58 | JRR10034 | J10000R2 | J10000P2 |
| J10032M | 32 | 2-1/8 | 2-1/8 | 15/16 | 1-13/64 | 2-19/32 | 1.51 | JRR10034 | J10000R2 | J10000P2 |
| J10033M | 33 | 2-1/8 | 2-1/8 | 1 | 1-1/4 | 2-3/4 | 1.48 | JRR10034 | J10000R2 | J10000P2 |
| J10035M | 35 | 2-13/64 | 2-1/8 | 1-13/32 | 1-13/64 | 2-45/64 | 1.63 | JRR10034 | J10000R2 | J10000P2 |
| J10036M | 36 | 2-1/4 | 2-1/8 | 27/32 | 1-13/64 | 2-7/16 | 1.73 | JRR10034 | J10000R2 | J10000P2 |
| J10038M | 38 | 2-25/64 | 2-25/64 | 1-13/32 | 1-1/4 | 2-45/64 | 1.91 | JRR10034 | J10000R2 | J10000P2 |
| J10041M | 41 | 2-31/64 | 2-13/32 | 1-1/8 | 1-1/4 | 2-13/16 | 2.07 | JRR10034 | J10000R2 | J10000P2 |
| J10046M | 46 | 2-25/32 | 2-13/32 | 1-5/16 | 1-13/32 | 2-13/16 | 2.63 | JRR10040 | - | - |
| J10050M | 50 | 3 | 2-13/32 | 1-7/16 | 1-1/2 | 3 | 3.20 | JRR10040 | - | - |
| J10054M | 54 | 3-3/32 | 2-13/32 | 1-19/32 | 1-1/2 | 3 | 3.33 | JRR10040 | - | - |
| J10055M | 55 | 3-1/4 | 2-13/32 | 1-9/16 | 1-9/16 | 3-1/8 | 3.71 | JRR10040 | - | - |
| J10058M | 58 | 3-1/2 | 2-7/16 | 1-43/64 | 2-13/32 | 3-13/64 | 3.85 | - | - | - |
| J10060M | 60 | 3-3/4 | 2-13/32 | 1-9/16 | 1-53/64 | 3-3/8 | 3.91 | - | - | - |
| J10063M | 63 | 3-3/4 | 2-13/32 | 1-9/16 | 1-13/16 | 3-3/8 | 4.12 | - | - | - |
| J10065M | 65 | 3-3/4 | 2-13/32 | 1-9/16 | 1-13/16 | 3-1/2 | 4.93 | - | - | - |
| J10067M | 67 | 3-3/4 | 2-3/4 | 2 | 2-21/64 | 3-1/2 | 4.93 | - | - | - |
| J10070M | 70 | 3-13/16 | 2-3/4 | 1-25/32 | 2-1/4 | 3-53/64 | 5.02 | - | - | - |
| J10075M | 75 | 4 | 2-3/4 | 2-13/64 | 2-11/16 | 3-27/32 | 6.15 | - | - | - |
| J10080M | 80 | 4-13/64 | 2-3/4 | 2-21/64 | 2-13/16 | 4 | 6.59 | - | - | - |



ASME B107.33M

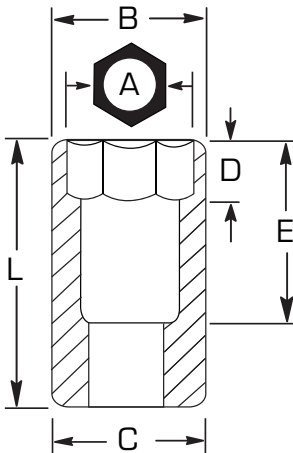



1" DRIVE DEEP IMPACT SOCKETS - 6 POINT

- ▶ Proto® 6 Point Impact Sockets are ideal for use on stubborn or damaged fasteners, and also on fasteners made from soft materials.
- ▶ TorquePlus™ features apply.



| Product # | Size (in) (A) | Nut End Outside Dia. (in) (B) | Drive End Outside Dia. (in) (C) | Nut Depth (in) (D) | Bolt Clearance Depth (in) (E) | Overall Length (in) (L) | Weight (lbs) | Crush Retaining Ring | O-Ring | Retaining Pin |
|-----------|---------------|-------------------------------|---------------------------------|--------------------|-------------------------------|-------------------------|--------------|----------------------|----------|---------------|
| J10014L | 7/8 | 1-35/64 | 2-1/8 | 21/32 | 2-5/8 | 3-3/4 | 2.45 | JRR10028 | J10000R1 | J10000P1 |
| J10015L | 15/16 | 1-39/64 | 2-1/8 | 49/64 | 2-5/8 | 3-3/4 | 2.64 | JRR10028 | J10000R1 | J10000P1 |
| J10016L | 1 | 1-3/4 | 2-1/8 | 3/4 | 2-5/8 | 3-3/4 | 2.66 | JRR10028 | J10000R1 | J10000P1 |
| J10017L | 1-1/16 | 1-3/4 | 2-1/8 | 7/8 | 2-5/8 | 3-3/4 | 2.54 | JRR10028 | J10000R1 | J10000P1 |
| J10018L | 1-1/8 | 1-13/16 | 2-1/8 | 7/8 | 2-5/8 | 3-3/4 | 2.53 | JRR10028 | J10000R1 | J10000P1 |
| J10019L | 1-3/16 | 1-7/8 | 2-1/8 | 7/8 | 2-5/8 | 3-3/4 | 2.32 | JRR10028 | J10000R1 | J10000P1 |
| J10020L | 1-1/4 | 2-1/8 | 2-1/8 | 15/16 | 2-5/8 | 3-3/4 | 2.55 | JRR10028 | J10000R1 | J10000P1 |
| J10021L | 1-5/16 | 2-1/8 | 2-1/8 | 1 | 2-5/8 | 3-3/4 | 2.45 | JRR10028 | J10000R1 | J10000P1 |
| J10022L | 1-3/8 | 2-1/8 | 2-1/8 | 1-1/32 | 2-5/8 | 3-3/4 | 2.38 | JRR10028 | J10000R1 | J10000P1 |
| J10023L | 1-7/16 | 2-1/8 | 2-1/8 | 1-3/8 | 2-5/32 | 4 | 2.52 | JRR10028 | J10000R1 | J10000P1 |
| J10024L | 1-1/2 | 2-3/8 | 2-3/8 | 1-3/8 | 2-5/32 | 4 | 2.80 | JRR10028 | J10000R1 | J10000P1 |
| J10025L | 1-9/16 | 2-3/8 | 2-3/8 | 2 | 2-3/8 | 4 | 2.89 | JRR10028 | J10000R1 | J10000P1 |
| J10026L | 1-5/8 | 2-3/8 | 2-3/8 | 2-1/4 | 2-53/64 | 4 | 2.73 | JRR10032 | J10000R2 | J10000P2 |
| J10027L | 1-11/16 | 2-39/64 | 2-3/8 | 2-1/4 | 2-53/64 | 4-1/16 | 3.45 | JRR10032 | J10000R2 | J10000P2 |
| J10028L | 1-3/4 | 2-39/64 | 2-3/8 | 2-1/4 | 2-53/64 | 4-1/16 | 3.31 | JRR10034 | J10000R2 | J10000P2 |
| J10029L | 1-13/16 | 2-3/4 | 2-3/8 | 2-1/4 | 2-53/64 | 4-1/16 | 3.65 | JRR10034 | J10000R2 | J10000P2 |
| J10030L | 1-7/8 | 2-3/4 | 2-3/8 | 2-3/8 | 2-3/4 | 4-1/4 | 3.74 | JRR10034 | J10000R2 | J10000P2 |
| J10031L | 1-15/16 | 2-7/8 | 2-3/8 | 2-3/8 | 2-3/4 | 4-1/4 | 4.05 | JRR10034 | J10000R2 | J10000P2 |
| J10032L | 2 | 3 | 2-3/8 | 2-3/8 | 2-3/4 | 4-1/4 | 4.31 | JRR10034 | J10000R2 | J10000P2 |
| J10033L | 2-1/16 | 3-1/8 | 2-3/8 | 2-9/16 | 2-3/4 | 4-1/4 | 4.52 | JRR10034 | J10000R2 | J10000P2 |
| J10034L | 2-1/8 | 3-1/8 | 2-3/8 | 2-19/32 | 2-31/32 | 4-1/2 | 4.78 | JRR10034 | J10000R2 | J10000P2 |
| J10035L | 2-3/16 | 3-1/4 | 2-3/8 | 2-9/16 | 2-15/16 | 4-1/2 | 5.19 | JRR10034 | J10000R2 | J10000P2 |
| J10036L | 2-1/4 | 3-1/4 | 2-3/8 | 2-17/32 | 2-29/32 | 4-1/2 | 4.98 | JRR10034 | J10000R2 | J10000P2 |
| J10037L | 2-5/16 | 3-1/2 | 2-3/8 | 2-17/32 | 2-29/32 | 4-3/4 | 5.92 | JRR10034 | J10000R2 | J10000P2 |
| J10038L | 2-3/8 | 3-1/2 | 2-3/8 | 2-3/4 | 3-1/8 | 4-3/4 | 8.06 | JRR10034 | J10000R2 | J10000P2 |
| J10039L | 2-7/16 | 3-9/16 | 2-3/8 | 3-7/8 | 3-3/16 | 4-7/8 | 5.82 | JRR10034 | J10000R2 | J10000P2 |
| J10040L | 2-1/2 | 3-5/8 | 2-3/8 | 3 | 3-1/4 | 4-7/8 | 6.02 | JRR10034 | J10000R2 | J10000P2 |
| J10041L | 2-9/16 | 3-5/8 | 2-3/8 | 3-1/8 | 3-5/16 | 5 | 6.33 | JRR10040 | - | - |
| J10042L | 2-5/5 | 3-3/4 | 2-3/8 | 3-1/16 | 3-7/16 | 5 | 6.75 | JRR10040 | - | - |
| J10044L | 2-3/4 | 3-7/8 | 2-3/8 | 3-1/16 | 3-1/2 | 5 | 7.10 | JRR10040 | - | - |



1" DRIVE IMPACT UNIVERSAL JOINT

- › Tight tolerances for snug fit on fastener.
- › Used wherever powered drive tools are used to install or remove fasteners.
- › Designed to withstand the high torque and force associated with impact tools in repetitive application.
- › Features two through holes and a groove to accept a Proto® Retaining Ring or pin and O-ring to help secure the socket to the drive tool anvil.
- › Position at appropriate angle to turn fasteners where obstructions prevent a straight application.
- › Ball and spring design which allows for a 30° working angle.
- › Smooth 360° rotation.

| Product # | Overall Length (in) (L) | Weight (lbs) |
|----------------|-------------------------|--------------|
| J10670A | 4-19/32 | 3.98 |



1" DRIVE IMPACT ADAPTERS

- › Use adapters to help increase or decrease drive end size.
- › Do not use hand adapters with power tools.
- › Do not over torque small sockets when using them with adapters on large drive tools.

| Product # | Size (in) | Overall Length (in) (L) | Weight (lbs) |
|---------------|-----------------|-------------------------|--------------|
| J15007 | 1-1/2" F x 1" M | 4-3/16 | 5.03 |
| J07655 | 3/4" F x 1" M | 2-1/2 | 0.89 |
| J07656 | 1" F x 3/4" M | 2-7/8 | 1.42 |
| J10004 | 1" F x 1-1/2" M | 3-1/2 | 2.64 |



ASME B107.2

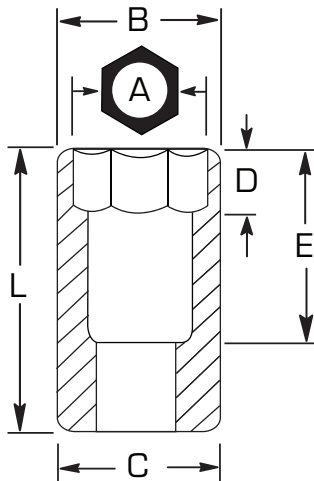

1" DRIVE IMPACT ADAPTER - MALE SPLINE

- › Use adapters to help increase or decrease drive end size.
- › Do not use hand adapters with power tools.
- › Do not over torque small sockets when using them with adapters on large drive tools.

| Product # | Size (in) | Overall Length (in) (L) | Weight (lbs) |
|---------------|----------------------|-------------------------|--------------|
| J10005 | 1" SQ. F x #5 SPL. M | 4-1/2 | 2.58 |



1" DRIVE BUDD WHEEL DEEP IMPACT SOCKET

- › Double opening: 13/16 square threads studs onto wheel, 1-1/2 hex tightens lug nuts.

| Product # | Size (in) | Drive Size (in) | Nut End Outside Dia. (in) (B) | Drive End Outside Dia. (in) (C) | Overall Length (in) (L) | Weight (lbs) |
|-----------------|-----------|-----------------|-------------------------------|---------------------------------|-------------------------|--------------|
| J10024LS | 1-1/2 | 1 | 2-3/8 | 2-3/8 | 4 | 2.96 |



1" DRIVE IMPACT EXTENSIONS

- › Use extensions to gain access to fasteners in locations that would otherwise be difficult to reach.
- › Male square is oriented in-line with female squares for use with fixed head torque wrenches.
- › Full chamfer at drive opening (when applicable) for easy engagement with drive tools.
- › Drive end chamfer and four detents help provide quick positive engagement with drive tool on any of the socket drive walls.
- › Stamped size for easy reference.
- › Side locking hole.

| Product # | Overall Length (in) (L) | Weight (lbs) |
|---------------|-------------------------|--------------|
| J10607 | 7-3/8 | 3.54 |
| J10608 | 10 | 4.49 |
| J10609 | 13 | 5.81 |



ASME B107.2



1" DRIVE RETAINING RINGS

- › Large drive size crush gauge retaining ring.
- › Part numbers are embossed on the rings near the point at which the pin and ring meet.



| Product # | Description | For Groove Dia. (in) | Diameter (in) | Height (in) | Weight (lbs) |
|-----------------|-----------------------------------|----------------------|---------------|-------------|--------------|
| JRR10028 | Retaining Ring 1" DR 1-3/4 Groove | 1-3/4 | 1-15/16 | 3/16 | 0.01 |
| JRR10032 | Retaining Ring 1" DR 2" Groove | 2 | 2-3/16 | 3/16 | 0.01 |
| JRR10034 | Retaining Ring 1" DR 2-1/8 Groove | 2-1/8 | 2-5/16 | 3/16 | 0.02 |
| JRR10036 | Retaining Ring 1" DR 2-1/4 Groove | 2-1/4 | 2-7/16 | 3/16 | 0.02 |
| JRR10040 | Retaining Ring 1" DR 2-1/2 Groove | 2-1/2 | 2-11/16 | 3/16 | 0.02 |
| JRR10042 | Retaining Ring 1" DR 2-5/8 Groove | 2-5/8 | 2-13/16 | 3/16 | 0.02 |



1" DRIVE O-RINGS

- › J10000R1 - "O" Ring for impact sockets with a 1" Drive.
- › Use with:
 - › J10012 thru J10023
 - › J10019M thru J10036M
 - › J10012SS thru J10018SS
 - › J100185, J10017-LT, J10020-LT, J10607, J10608, J10609
- › J10000R2 - "O" Ring for impact sockets with a 1" Drive.
- › Use with:
 - › J10024 thru J10072
 - › J10041M thru J10065M
 - › J10024L thru J10044L
 - › J10024LS, J10670, J10004, J10005

| Product # | Drive Size (in) | Weight (lbs) |
|-----------------|-----------------|--------------|
| J10000R1 | 1 | 0.01 |
| J10000R2 | 1 | 0.01 |



1" DRIVE RETAINING PINS

- › J10000P1 - Use for a variety of impact sockets and attachments.
- › Use with:
 - › J10012 thru J10023
 - › J10019M thru J10036M
 - › J10012SS thru J10018SS
 - › J100185, J10017-LT, J10020-LT, J10607, J10608, J10609
- › J10000P2 - Use for a variety of impact sockets and attachments.
- › Use with:
 - › J10024 thru J10072
 - › J10041M thru J10065M
 - › J10024L thru J10044L
 - › J10024LS, J10670, J10004, J10005

| Product # | Drive Size (in) | Weight (lbs) |
|-----------------|-----------------|--------------|
| J10000P1 | 1 | 0.02 |
| J10000P2 | 1 | 0.02 |



1-1/2" DRIVE IMPACT SOCKETS - 6 POINT

- › Proto® 6 Point Impact Sockets are ideal for use on stubborn or damaged fasteners, and also on fasteners made from soft materials.
- › TorquePlus™ features apply.
- › Stamped size for easy reference.
- › Side locking hole.



| Product # | Size (in) (A) | Nut End | Drive End | Nut | Bolt Clearance | Overall | Weight (lbs) | Crush Retaining Ring |
|-----------|---------------|-----------------------|-----------------------|----------------|----------------|-----------------|--------------|----------------------|
| | | Outside Dia. (in) (B) | Outside Dia. (in) (C) | Depth (in) (D) | Depth (in) (E) | Length (in) (L) | | |
| J15021 | 1-5/16 | 2-3/4 | 3-1/4 | 3/4 | 1-3/8 | 3-1/8 | 4.78 | JRR15046 |
| J15022 | 1-3/8 | 2-19/32 | 3-1/4 | 7/8 | 1-1/2 | 3-1/8 | 4.69 | JRR15046 |
| J15023 | 1-7/16 | 2-19/32 | 3-1/4 | 7/8 | 1-1/2 | 3-1/8 | 4.76 | JRR15046 |
| J15024 | 1-1/2 | 2-19/32 | 3-1/4 | 15/16 | 1-1/2 | 3-1/8 | 4.67 | JRR15046 |
| J15025 | 1-9/16 | 2-3/4 | 3-1/4 | 31/32 | 1-1/2 | 3-1/8 | 4.78 | JRR15046 |
| J15026 | 1-5/8 | 2-7/8 | 3-1/4 | 31/32 | 1-1/2 | 3-1/8 | 4.91 | JRR15046 |
| J15027 | 1-11/16 | 2-7/8 | 3-1/4 | 1-1/16 | 1-19/32 | 3-15/64 | 5.01 | JRR15046 |
| J15028 | 1-3/4 | 2-15/16 | 3-1/4 | 1-3/32 | 1-21/32 | 3-11/32 | 5.22 | JRR15046 |
| J15029 | 1-13/16 | 3 | 3-1/4 | 1-1/8 | 1-21/32 | 3-11/32 | 5.00 | JRR15046 |
| J15030 | 1-7/8 | 3 | 3-1/4 | 1-3/16 | 1-45/64 | 3-11/32 | 5.33 | JRR15046 |
| J15031 | 1-15/16 | 3 | 3-1/4 | 1-1/8 | 2 | 3-5/8 | 5.33 | JRR15046 |
| J15032 | 2 | 3-1/4 | 3-1/4 | 1-1/4 | 1-13/32 | 3-5/8 | 5.65 | JRR15046 |
| J15033 | 2-1/16 | 3-1/4 | 3-1/4 | 1-9/32 | 1-11/16 | 3-5/8 | 5.50 | JRR15046 |
| J15034 | 2-1/8 | 3-1/2 | 3-1/4 | 1-11/32 | 1-43/64 | 3-5/8 | 6.68 | JRR15054 |
| J15035 | 2-3/16 | 3-1/2 | 3-1/4 | 1-3/8 | 1-21/32 | 3-5/8 | 6.47 | JRR15054 |
| J15036 | 2-1/4 | 3-1/2 | 3-1/4 | 1-1/2 | 1-3/4 | 3-3/4 | 7.98 | JRR15054 |
| J15037 | 2-5/16 | 3-1/2 | 3-1/4 | 1-1/2 | 1-53/64 | 3-7/8 | 7.93 | JRR15054 |
| J15038 | 2-3/8 | 3-1/4 | 3-1/4 | 1-9/16 | 1-55/64 | 3-7/8 | 7.90 | JRR15054 |
| J15039 | 2-7/16 | 3-3/4 | 3-1/4 | 1-9/16 | 1-15/16 | 3-7/8 | 8.52 | JRR15054 |
| J15040 | 2-1/2 | 3-3/4 | 3-1/4 | 1-5/8 | 1-59/64 | 4 | 8.40 | JRR15054 |
| J15041 | 2-9/16 | 3-3/4 | 3-1/4 | 1-5/8 | 1-29/32 | 4 | 8.92 | JRR15054 |
| J15042 | 2-5/8 | 4-1/8 | 3-1/4 | 1-5/8 | 2 | 4-1/8 | 8.84 | JRR15054 |
| J15043 | 2-11/16 | 4-1/8 | 3-1/4 | 1-3/4 | 2-7/64 | 4-1/4 | 9.25 | JRR15054 |
| J15044 | 2-3/4 | 4-1/4 | 3-1/4 | 1-3/4 | 2-5/64 | 4-1/4 | 10.03 | JRR15054 |
| J15045 | 2-13/16 | 4-1/4 | 3-1/4 | 1-7/8 | 2-3/16 | 4-3/8 | 9.83 | JRR15054 |
| J15046 | 2-7/8 | 4-1/2 | 3-1/4 | 1-7/8 | 2-11/64 | 4-3/8 | 11.36 | JRR15054 |
| J15047 | 2-15/16 | 4-1/2 | 3-1/4 | 2 | 2-17/16 | 4-1/2 | 11.24 | JRR15054 |
| J15048 | 3 | 4-1/2 | 3-1/4 | 2 | 2-1/4 | 4-1/2 | 12.59 | JRR15054 |
| J15049 | 3-1/16 | 4-3/4 | 3-1/4 | 2 | 2-23/64 | 4-5/8 | 12.53 | JRR15054 |
| J15050 | 3-1/8 | 4-3/4 | 3-1/4 | 2 | 2-23/64 | 4-5/8 | 12.42 | JRR15054 |
| J15051 | 3-3/16 | 4-3/4 | 3-1/4 | 2 | 2-9/16 | 4-23/32 | 12.15 | JRR15054 |
| J15052 | 3-1/4 | 5 | 3-1/4 | 2 | 2-35/64 | 4-23/32 | 14.08 | JRR15054 |
| J15053 | 3-5/16 | 5 | 3-1/4 | 2 | 2-31/64 | 4-23/32 | 13.79 | JRR15054 |
| J15054 | 3-3/8 | 5 | 3-1/4 | 2 | 2-33/64 | 4-23/32 | 13.67 | JRR15054 |
| J15055 | 3-7/16 | 5 | 3-1/4 | 2 | 2-39/64 | 4-31/32 | 13.44 | - |
| J15056 | 3-1/2 | 5-1/8 | 3-1/4 | 2-1/4 | 2-37/64 | 4-31/32 | 14.46 | - |
| J15057 | 3-9/16 | 5-1/8 | 3-1/4 | 2-1/4 | 2-9/16 | 5 | 12.54 | - |
| J15058 | 3-5/8 | 5-1/8 | 3-1/4 | 2-1/4 | 2-35/64 | 5 | 14.73 | - |
| J15059 | 3-11/16 | 5-1/8 | 3-1/4 | 2-1/4 | 2-33/64 | 5 | 14.67 | - |
| J15060 | 3-3/4 | 5-1/2 | 3-1/4 | 2-1/4 | 2-1/2 | 5 | 16.75 | - |
| J15061 | 3-13/16 | 5-1/2 | 3-1/4 | 2-1/4 | 2-31/64 | 5 | 19.49 | - |
| J15062 | 3-7/8 | 5-1/2 | 3-1/4 | 2-1/4 | 2-31/32 | 5-1/2 | 18.70 | - |
| J15063 | 3-15/16 | 5-3/4 | 3-1/4 | 2-1/2 | 2-15/16 | 5-1/2 | 21.33 | - |
| J15064 | 4 | 5-3/4 | 3-1/4 | 2-1/2 | 2-59/64 | 5-1/2 | 20.66 | - |
| J15065 | 4-1/16 | 5-3/4 | 3-1/4 | 2-3/4 | 2-29/32 | 5-1/2 | 20.25 | - |
| J15066 | 4-1/8 | 6 | 3-1/4 | 2-3/4 | 3-1/8 | 5-3/4 | 26.72 | - |



| Product # | Size (in) (A) | Nut End Outside Dia. (in) (B) | Drive End Outside Dia. (in) (C) | Nut Depth (in) (D) | Bolt Clearance Depth (in) (E) | Overall Length (in) (L) | Weight (lbs) | Crush Retaining Ring |
|-----------|---------------|-------------------------------|---------------------------------|--------------------|-------------------------------|-------------------------|--------------|----------------------|
| J15067 | 4-3/16 | 6-11/16 | 3-3/4 | 3-1/8 | 4-5/8 | 6-1/4 | 26.17 | - |
| J15068 | 4-1/4 | 6 | 3-1/4 | 2-3/4 | 3-5/64 | 5-3/4 | 27.05 | - |
| J15069 | 4-5/16 | 6 | 3-1/4 | 2-3/4 | 3-1/16 | 5-3/4 | 27.66 | - |
| J15070 | 4-3/8 | 6-1/4 | 3-1/4 | 2-3/4 | 3-3/64 | 5-3/4 | 28.23 | - |
| J15071 | 4-7/16 | 6-1/4 | 3-1/4 | 3 | 3-17/64 | 6 | 18.63 | - |
| J15072 | 4-1/2 | 6-1/4 | 3-1/4 | 3 | 3-1/4 | 6 | 28.40 | - |
| J15074 | 4-5/8 | 6-1/2 | 3-1/4 | 3 | 3-15/32 | 6-1/4 | 29.98 | - |
| J15076 | 4-3/4 | 6-1/2 | 3-1/4 | 3 | 3-27/64 | 6-1/4 | 30.15 | - |
| J15080 | 5 | 6-3/4 | 3-1/2 | 3 | 3-1/2 | 6-3/4 | 25.16 | - |



ASME B107.2

1-1/2" DRIVE METRIC IMPACT SOCKETS - 6 POINT

- ▶ Proto® 6 Point Impact Sockets are ideal for use on stubborn or damaged fasteners, and also on fasteners made from soft materials.
- ▶ TorquePlus™ features apply.
- ▶ Stamped size for easy reference.
- ▶ Side locking hole.



METRIC

| Product # | Size (mm) (A) | Nut End Outside Dia. (in) (B) | Drive End Outside Dia. (in) (C) | Nut Depth (in) (D) | Bolt Clearance Depth (in) (E) | Overall Length (in) (L) | Weight (lbs) | Crush Retaining Ring | O-Ring | Retaining Pin |
|-----------|---------------|-------------------------------|---------------------------------|--------------------|-------------------------------|-------------------------|--------------|----------------------|----------|---------------|
| J15036M | 36 | 2-3/4 | 3-1/4 | 7/8 | 1-3/8 | 3-3/16 | 4.73 | JRR10034 | J10000R2 | J10000P2 |
| J15038M | 38 | 2-7/8 | 3-1/4 | 7/8 | 1-7/16 | 3-1/4 | 4.85 | JRR10034 | J10000R2 | J10000P2 |
| J15060M | 60 | 3-5/8 | 3-5/8 | 1-3/8 | 2-3/8 | 4 | 8.71 | - | - | - |
| J15065M | 65 | 3-7/8 | 3-7/8 | 1-1/2 | 2-1/2 | 4-3/16 | 8.75 | - | - | - |
| J15070M | 70 | 4-1/16 | 3-3/4 | 1-5/8 | 2-3/4 | 4-3/8 | 9.72 | - | - | - |
| J15075M | 75 | 4-5/16 | 3-3/4 | 1-3/4 | 2-7/8 | 4-1/2 | 11.04 | - | - | - |



1-1/2" DRIVE DEEP IMPACT SOCKETS - 6 POINT

- ▶ Proto® 6 Point Impact Sockets are ideal for use on stubborn or damaged fasteners, and also on fasteners made from soft materials.
- ▶ TorquePlus™ features apply.
- ▶ Stamped size for easy reference.
- ▶ Side locking hole.



| Product # | Size (in) (A) | Nut End Outside Dia. (in) (B) | Drive End Outside Dia. (in) (C) | Nut Depth (in) (D) | Bolt Clearance Depth (in) (E) | Overall Length (in) (L) | Weight (lbs) | Crush Retaining Ring | O-Ring | Retaining Pin |
|-----------|---------------|-------------------------------|---------------------------------|--------------------|-------------------------------|-------------------------|--------------|----------------------|----------|---------------|
| J15021L | 1-5/16 | 2-3/4 | 3-1/4 | 13/16 | 4 | 5-11/16 | 10.23 | JRR15046 | J10000R2 | J10000P2 |
| J15022L | 1-3/8 | 2-19/32 | 3-1/4 | 7/8 | 4-1/8 | 5-3/4 | 9.18 | JRR15046 | J10000R2 | J10000P2 |
| J15023L | 1-7/16 | 2-19/32 | 3-1/4 | 7/8 | 4-1/8 | 5-3/4 | 9.09 | JRR15046 | - | - |
| J15024L | 1-1/2 | 2-19/32 | 3-1/4 | 15/16 | 4-1/8 | 5-3/4 | 9.13 | JRR15046 | - | - |
| J15025L | 1-9/16 | 2-7/8 | 3-1/4 | 31/32 | 4-1/8 | 5-3/4 | 8.86 | JRR15046 | - | - |
| J15026L | 1-5/8 | 2-7/8 | 3-1/4 | 31/32 | 4-1/8 | 5-3/4 | 9.37 | JRR15046 | - | - |
| J15027L | 1-11/16 | 2-7/8 | 3-1/4 | 1-1/16 | 4-1/8 | 5-3/4 | 9.19 | JRR15046 | - | - |
| J15028L | 1-3/4 | 2-15/16 | 3-1/4 | 1-3/32 | 4-1/8 | 5-3/4 | 8.80 | JRR15046 | - | - |
| J15029L | 1-13/16 | 3-1/8 | 3-1/4 | 1-1/8 | 4-1/8 | 5-3/4 | 9.52 | JRR15046 | - | - |
| J15030L | 1-7/8 | 3-1/8 | 3-1/4 | 1-3/16 | 4-1/8 | 5-3/4 | 9.30 | JRR15046 | - | - |
| J15031L | 1-15/16 | 3-1/8 | 3-1/4 | 1-1/8 | 4-1/8 | 5-3/4 | 8.78 | JRR15046 | - | - |
| J15032L | 2 | 3-1/4 | 3-1/4 | 1-21/32 | 3-53/64 | 5-3/4 | 9.40 | JRR15046 | - | - |
| J15033L | 2-1/16 | 3-1/4 | 3-1/4 | 1-45/64 | 3-13/16 | 5-3/4 | 8.27 | JRR15046 | - | - |
| J15034L | 2-1/8 | 3-1/2 | 3-1/4 | 1-3/4 | 3-57/64 | 5-3/4 | 9.35 | JRR15054 | J10000R2 | J10000P2 |
| J15035L | 2-3/16 | 3-1/2 | 3-1/4 | 1-51/64 | 3-57/64 | 5-3/4 | 8.83 | JRR15054 | J10000R2 | J10000P2 |

(CONTINUED ON NEXT PAGE)



1-1/2" DRIVE DEEP IMPACT SOCKETS (CONTINUED)

| Product # | Size (in) (A) | Nut End Outside Dia. (in) (B) | Drive End Outside Dia. (in) (C) | Nut Depth (in) (D) | Bolt Clearance Depth (in) (E) | Overall Length (in) (L) | Weight (lbs) | Crush Retaining Ring | O-Ring | Retaining Pin |
|-----------|---------------|-------------------------------|---------------------------------|--------------------|-------------------------------|-------------------------|--------------|----------------------|--------|---------------|
| J15036L | 2-1/4 | 3-1/2 | 3-1/4 | 1-27/32 | 3-57/64 | 5-7/8 | 8.78 | JRR15054 | - | - |
| J15037L | 2-5/16 | 3-1/2 | 3-1/4 | 1-29/32 | 3-57/64 | 5-7/8 | 8.47 | JRR15054 | - | - |
| J15038L | 2-3/8 | 3-3/4 | 3-1/4 | 1-61/64 | 3-57/64 | 5-7/8 | 12.21 | JRR15054 | - | - |
| J15039L | 2-7/16 | 3-3/4 | 3-1/4 | 2-1/64 | 3-15/16 | 6 | 13.56 | JRR15054 | - | - |
| J15040L | 2-1/2 | 3-3/4 | 3-1/4 | 2-1/16 | 3-59/64 | 6 | 13.41 | JRR15054 | - | - |
| J15041L | 2-9/16 | 3-3/4 | 3-1/4 | 2-7/64 | 3-57/64 | 6 | 14.28 | JRR15054 | - | - |
| J15042L | 2-5/8 | 4-1/8 | 3-1/4 | 2-5/32 | 3-57/64 | 6 | 11.59 | JRR15054 | - | - |
| J15043L | 2-11/16 | 4-1/8 | 3-1/4 | 2-7/32 | 3-63/64 | 6-1/8 | 14.50 | JRR15054 | - | - |
| J15044L | 2-3/4 | 4-1/4 | 3-1/4 | 2-17/64 | 3-31/32 | 6-1/8 | 15.25 | JRR15054 | - | - |
| J15045L | 2-13/16 | 4-1/4 | 3-1/4 | 2-5/16 | 4-1/16 | 6-1/4 | 15.53 | JRR15054 | - | - |
| J15046L | 2-7/8 | 4-1/2 | 3-1/4 | 2-3/8 | 4-3/64 | 6-1/4 | 17.74 | JRR15054 | - | - |
| J15047L | 2-15/16 | 4-1/2 | 3-1/4 | 2-27/64 | 4-1/64 | 6-1/4 | 17.25 | JRR15054 | - | - |
| J15048L | 3 | 4-1/2 | 3-1/4 | 2-15/32 | 4-1/8 | 6-3/8 | 19.17 | JRR15054 | - | - |
| J15049L | 3-1/16 | 4-3/4 | 3-1/4 | 2-33/64 | 4-1/8 | 6-3/8 | 15.76 | JRR15054 | - | - |
| J15050L | 3-1/8 | 4-3/4 | 3-1/4 | 2-37/64 | 4-5/64 | 6-3/8 | 18.89 | JRR15054 | - | - |
| J15051L | 3-3/16 | 4-3/4 | 3-1/4 | 2-5/8 | 4-3/16 | 6-1/2 | 19.16 | JRR15054 | - | - |
| J15052L | 3-1/4 | 5 | 3-1/4 | 2-43/64 | 4-5/32 | 6-1/2 | 21.66 | JRR15054 | - | - |
| J15053L | 3-5/16 | 5 | 3-1/4 | 2-47/64 | 4-1/8 | 6-1/2 | 21.33 | JRR15054 | - | - |
| J15054L | 3-3/8 | 5 | 3-1/4 | 2-25/32 | 4-1/8 | 6-1/2 | 21.10 | JRR15054 | - | - |
| J15055L | 3-7/16 | 5 | 3-1/4 | 2-27/32 | 4-7/64 | 6-1/2 | 20.78 | - | - | - |
| J15056L | 3-1/2 | 5-1/8 | 3-1/4 | 2-7/8 | 4-5/64 | 6-1/2 | 21.68 | - | - | - |
| J15057L | 3-9/16 | 5-1/8 | 3-1/4 | 2-15/16 | 4-5/16 | 6-3/4 | 17.24 | - | - | - |
| J15058L | 3-5/8 | 5-1/8 | 3-1/4 | 2-63/64 | 4-19/64 | 6-3/4 | 17.48 | - | - | - |
| J15059L | 3-11/16 | 5-1/8 | 3-1/4 | 3-1/32 | 4-17/64 | 6-3/4 | 16.2 | - | - | - |
| J15060L | 3-3/4 | 5-1/2 | 3-1/4 | 3-3/32 | 4-15/64 | 6-3/4 | 26.63 | - | - | - |
| J15061L | 3-13/16 | 5-1/2 | 3-1/4 | 3-9/64 | 4-15/64 | 6-3/4 | 18.52 | - | - | - |
| J15062L | 3-7/8 | 5-1/2 | 3-1/4 | 3-3/16 | 4-7/32 | 6-3/4 | 27.36 | - | - | - |
| J15063L | 3-15/16 | 5-3/4 | 3-1/4 | 3-1/4 | 4-7/16 | 7 | 21.16 | - | - | - |
| J15064L | 4 | 5-3/4 | 3-1/4 | 3-19/64 | 4-7/16 | 7 | 30.47 | - | - | - |
| J15065L | 4-1/16 | 5-3/4 | 3-1/4 | 3-11/32 | 4-25/64 | 7 | 19.43 | - | - | - |
| J15066L | 4-1/8 | 6 | 3-1/4 | 3-25/64 | 4-25/64 | 7 | 36.26 | - | - | - |
| J15067L | 4-3/16 | 6 | 3-1/4 | 3-7/16 | 5-1/32 | 7-1/4 | 21.71 | - | - | - |
| J15068L | 4-1/4 | 6 | 3-1/4 | 3-1/2 | 4-37/64 | 7-1/4 | 22.36 | - | - | - |
| J15069L | 4-5/16 | 6 | 3-1/4 | 3-9/16 | 4-9/16 | 7-1/4 | 28.73 | - | - | - |
| J15070L | 4-3/8 | 6-1/4 | 3-1/4 | 3-39/64 | 4-35/64 | 7-1/4 | 24.04 | - | - | - |
| J15072L | 4-1/2 | 6-1/4 | 3-1/4 | 3-45/64 | 4-1/2 | 7-1/4 | 35.85 | - | - | - |
| J15074L | 4-5/8 | 6-1/2 | 3-1/4 | 3-13/16 | 4-23/32 | 7-1/2 | 41.32 | - | - | - |
| J15076L | 4-3/4 | 6-1/2 | 3-1/4 | 3-29/32 | 4-43/64 | 7-1/2 | 24.23 | - | - | - |



ASME B107.2

1-1/2" DRIVE IMPACT UNIVERSAL JOINT

- ▶ Tight tolerances for snug fit on fastener.
- ▶ Used wherever powered drive tools are used to install or remove fasteners.
- ▶ Designed to withstand the high torque and force associated with impact tools in repetitive application.
- ▶ Features two through holes and a groove to accept a Proto® Retaining Ring or pin and O-ring to help secure the socket to the drive tool anvil.
- ▶ Position at appropriate angle to turn fasteners where obstructions prevent a straight application.
- ▶ Ball and spring design which allows for a 30° working angle.
- ▶ Smooth 360° rotation.

| Product # | Overall Length (in) (L) | Weight (lbs) |
|-----------|-------------------------|--------------|
| J15670A | 6-19/64 | 9.35 |





1-1/2" DRIVE IMPACT ADAPTERS

- › Use adapters to help increase or decrease drive end size.
- › Do not use hand adapters with power tools.
- › Do not over torque small sockets when using them with adapters on large drive tools.

| Product # | Size (in) | Overall Length (in) (L) | Weight (lbs) |
|-----------|-----------------|-------------------------|--------------|
| J15007 | 1-1/2" F x 1" M | 4-3/16 | 5.03 |
| J10004 | 1" F x 1-1/2" M | 3-1/2 | 2.64 |

ASME B107.2



1-1/2" DRIVE IMPACT ADAPTER - MALE SPLINE

- › Use adapters to help increase or decrease drive end size.
- › Do not use hand adapters with power tools.
- › Do not over torque small sockets when using them with adapters on large drive tools.

| Product # | Size (in) | Overall Length (in) (L) | Weight (lbs) |
|-----------|----------------------|-------------------------|--------------|
| J15005 | 1-1/2" F x #5 SPL. M | 5-3/8 | 5.94 |



1-1/2" DRIVE IMPACT EXTENSIONS

- › Drive end chamfer and four detents help provide quick positive engagement with drive tool on any of the socket drive walls.
- › Tight tolerances for snug fit on fastener.
- › Large clearance holes, concentric opening and nut end chamfer make it easy to position socket on fasteners.
- › Made from high-strength steel to help minimize wall thickness and provide access to fasteners in recesses and where nuts and bolts protrude.
- › Impact sockets are used wherever powered drive tools are used to install or remove fasteners.
- › Impact sockets are designed to withstand the high torque and force associated with impact tools in repetitive application.
- › Use extensions to gain access to fasteners in locations that would otherwise be difficult to reach.
- › Male square is oriented in line with female squares for use with fixed head torque wrenches.
- › Full chamfer at drive opening (when applicable) for easy engagement with drive tools.

| Product # | Overall Length (in) (L) | Weight (lbs) |
|-----------|-------------------------|--------------|
| J15097P | 8 | 9.17 |
| J15098P | 12 | 12.66 |
| J15099P | 15 | 15.58 |



1-1/2" DRIVE RETAINING RINGS

- › Large drive size crush gauge retaining ring.
- › Part numbers are embossed on the rings near the point at which the pin and ring meet.



| Product # | Description | For Groove Dia. (in) | Diameter (in) | Height (in) | Weight (lbs) |
|-----------|---|----------------------|---------------|-------------|--------------|
| JRR15046 | Retaining Ring, CG 1-1/2" DR 2-7/8 Groove | 2-7/8 | 3-3/8 | 1/4 | 0.03 |
| JRR15054 | Retaining Ring, CG 1-1/2" DR 3-3/8 Groove | 3-3/8 | 3-7/8 | 1/4 | 0.03 |
| JRR15062 | Retaining Ring, CG 1-1/2" DR 3-7/8 Groove | 3-7/8 | 4-3/8 | 1/4 | 0.04 |
| JRR15070 | Retaining Ring, CG 1-1/2" DR 4-3/8 Groove | 4-3/8 | 4-7/8 | 1/4 | 0.04 |

2-1/2" DRIVE IMPACT SOCKETS - 6 POINT

- › Proto® 6 Point Impact Sockets are ideal for use on stubborn or damaged fasteners, and also on fasteners made from soft materials.
- › TorquePlus™ features apply.



| Product # | Size (in) (A) | Nut End Outside Dia. (in) (B) | Drive End Outside Dia. (in) (C) | Nut Depth (in) (D) | Bolt Clearance Depth (in) (E) | Overall Length (in) (L) | Weight (lbs) |
|-----------|---------------|-------------------------------|---------------------------------|--------------------|-------------------------------|-------------------------|--------------|
| J25028 | 1-3/4 | 4-3/16 | 5 | 1-1/8 | 2-7/8 | 5-3/8 | 21.08 |
| J25030 | 1-7/8 | 4-5/16 | 5 | 1-3/16 | 2-7/8 | 5-3/8 | 20.97 |
| J25032 | 2 | 4-3/8 | 5 | 1-1/4 | 2-7/8 | 5-3/8 | 20.80 |
| J25034 | 2-1/8 | 4-1/2 | 5 | 1-3/8 | 2-7/8 | 5-3/8 | 20.59 |
| J25036 | 2-1/4 | 4-9/16 | 5 | 1-7/16 | 3 | 5-1/2 | 21.06 |
| J25038 | 2-3/8 | 4-5/8 | 5 | 1-1/2 | 3 | 5-1/2 | 20.85 |
| J25040 | 2-1/2 | 4-3/4 | 5 | 1-9/16 | 3 | 5-1/2 | 20.65 |
| J25041 | 2-9/16 | 4-3/4 | 5 | 1-5/8 | 3 | 5-1/2 | 20.61 |
| J25042 | 2-5/8 | 4-13/16 | 5 | 1-11/16 | 3 | 5-1/2 | 20.53 |
| J25044 | 2-3/4 | 4-15/16 | 5 | 1-3/4 | 3-1/8 | 5-5/8 | 20.89 |
| J25046 | 2-7/8 | 5 | 5 | 1-13/16 | 3-1/8 | 5-5/8 | 20.87 |
| J25047 | 2-15/16 | 5-1/16 | 5-1/16 | 1-7/8 | 3-1/8 | 5-5/8 | 21.16 |
| J25048 | 3 | 5-1/8 | 5-1/8 | 2 | 3-1/8 | 5-5/8 | 21.30 |
| J25050 | 3-1/8 | 5-3/16 | 5-3/16 | 2 | 3-1/4 | 5-3/4 | 22.63 |
| J25052 | 3-1/4 | 5-5/16 | 5-5/16 | 2-1/16 | 3-1/4 | 5-3/4 | 23.79 |
| J25054 | 3-3/8 | 5-7/16 | 5-7/16 | 2-1/8 | 3-1/4 | 5-3/4 | 24.84 |
| J25055 | 3-7/16 | 5-1/2 | 5-1/2 | 2-3/16 | 3-1/4 | 5-3/4 | 25.29 |
| J25056 | 3-1/2 | 5-9/16 | 5-9/16 | 2-1/4 | 3-1/4 | 5-3/4 | 25.77 |
| J25058 | 3-5/8 | 5-11/16 | 5-11/16 | 2-5/16 | 3-1/4 | 5-3/4 | 26.99 |
| J25060 | 3-3/4 | 5-13/16 | 5-13/16 | 2-3/8 | 3-3/4 | 6-1/4 | 31.04 |
| J25062 | 3-7/8 | 5-15/16 | 5-15/16 | 2-1/2 | 3-3/4 | 6-1/4 | 32.27 |
| J25064 | 4 | 6-1/16 | 6-1/16 | 2-1/2 | 3-3/4 | 6-1/4 | 33.70 |
| J25066 | 4-1/8 | 6-3/16 | 6 | 2-5/8 | 3-3/4 | 6-1/4 | 34.69 |
| J25068 | 4-1/4 | 6-5/16 | 6 | 2-3/4 | 4-1/4 | 6-3/4 | 37.32 |
| J25070 | 4-3/8 | 6-7/16 | 6 | 2-3/4 | 4-1/4 | 6-3/4 | 38.04 |
| J25072 | 4-1/2 | 6-9/16 | 6 | 2-7/8 | 4-1/2 | 7 | 40.41 |
| J25074 | 4-5/8 | 6-11/16 | 6 | 3 | 4-1/2 | 7 | 40.54 |
| J25076 | 4-3/4 | 6-13/16 | 6 | 3 | 4-1/2 | 7 | 41.29 |
| J25078 | 4-7/8 | 6-15/16 | 6 | 3 | 4-3/4 | 7-1/4 | 42.94 |
| J25080 | 5 | 7-1/16 | 6 | 3-3/16 | 5 | 7-1/2 | 45.46 |
| J25082 | 5-1/8 | 7-1/4 | 6 | 3-5/16 | 5 | 7-1/2 | 46.12 |
| J25084 | 5-1/4 | 7-3/8 | 6 | 3-5/16 | 5 | 7-1/2 | 47.47 |
| J25086 | 5-3/8 | 7-1/2 | 6 | 3-3/8 | 5-1/4 | 7-3/4 | 50.48 |
| J25087 | 5-7/16 | 7-9/16 | 6 | 3-7/16 | 5-1/4 | 7-3/4 | 50.92 |
| J25088 | 5-1/2 | 7-5/8 | 6 | 3-1/2 | 5-1/4 | 7-3/4 | 51.41 |





| Product # | Size (in) (A) | Nut End Outside Dia. (in) (B) | Drive End Outside Dia. (in) (C) | Nut Depth (in) (D) | Bolt Clearance Depth (in) (E) | Overall Length (in) (L) | Weight (lbs) |
|-----------|---------------|-------------------------------|---------------------------------|--------------------|-------------------------------|-------------------------|--------------|
| J25090 | 5-5/8 | 7-13/16 | 6 | 3-9/16 | 5-1/4 | 7-3/4 | 52.50 |
| J25092 | 5-3/4 | 7-15/16 | 6 | 3-5/8 | 5-1/4 | 7-3/4 | 53.43 |
| J25094 | 5-7/8 | 8-1/16 | 6 | 3-3/4 | 5-1/4 | 7-3/4 | 53.75 |
| J25096 | 6 | 8-1/4 | 6 | 3-13/16 | 5-3/8 | 7-7/8 | 56.13 |
| J25098 | 6-1/8 | 8-3/8 | 6 | 3-7/8 | 5-3/8 | 7-7/8 | 56.72 |
| J25100 | 6-1/4 | 8-1/2 | 6 | 3-7/8 | 5-3/8 | 7-7/8 | 57.61 |
| J25102 | 6-3/8 | 8-11/16 | 6 | 4 | 5-1/2 | 8 | 59.32 |
| J25104 | 6-1/2 | 8-13/16 | 6 | 4 | 5-1/2 | 8 | 60.35 |
| J25106 | 6-5/8 | 8-15/16 | 6-1/2 | 4-1/4 | 5-1/2 | 8 | 63.91 |
| J25108 | 6-3/4 | 9-1/8 | 6-1/2 | 4-1/4 | 5-1/2 | 8 | 64.60 |
| J25110 | 6-7/8 | 9-1/4 | 6-1/2 | 4-5/16 | 5-1/2 | 8 | 65.05 |
| J25112 | 7 | 9-3/8 | 6-1/2 | 4-5/16 | 5-1/2 | 8 | 66.10 |
| J25114 | 7-1/8 | 9-9/16 | 6-1/2 | 4-5/16 | 5-1/2 | 8 | 67.21 |
| J25116 | 7-1/4 | 9-11/16 | 6-1/2 | 4-5/16 | 6 | 8-1/2 | 75.16 |
| J25118 | 7-3/8 | 9-13/16 | 6-1/2 | 4-5/16 | 6 | 8-1/2 | 76.28 |
| J25120 | 7-1/2 | 10 | 6-1/2 | 4-5/16 | 6 | 8-1/2 | 77.24 |
| J25122 | 7-5/8 | 10-1/8 | 6-1/2 | 4-5/16 | 6 | 8-1/2 | 77.98 |
| J25124 | 7-3/4 | 10-1/4 | 6-1/2 | 4-5/16 | 6 | 8-1/2 | 78.65 |
| J25126 | 7-7/8 | 10-3/8 | 6-1/2 | 4-5/16 | 6-1/4 | 8-3/4 | 84.00 |
| J25128 | 8 | 10-9/16 | 6-1/2 | 4-5/16 | 6-1/4 | 8-3/4 | 86.44 |

2-1/2" DRIVE RETAINING PIN

- › Large drive size crush gauge retaining ring.
- › Part numbers are embossed on the rings near the point at which the pin and ring meet.

| Product # | Description | For Groove Dia. (in) | Diameter (in) | Height (in) | Weight (lbs) |
|-----------|--------------------------|----------------------|---------------|-------------|--------------|
| JRP25000 | Retaining Pin, 2-1/2" DR | 2 | 4-1/2 | 1/2 | 0.21 |

PRODUCT FEATURES AND BENEFITS —

- › High performance drive configuration allows for quick and easy socket engagement to the fastener flats, not the corners.
- › Employs a radius-corner design, shifting contact area and stress away from the fastener corners and distributing contact stresses over a large area of the socket, minimizing slippage.
- › The internal design minimizes fastener rounding, helps to extend fastener life, and allows the user to more easily turn worn, rounded, or rusted fasteners.

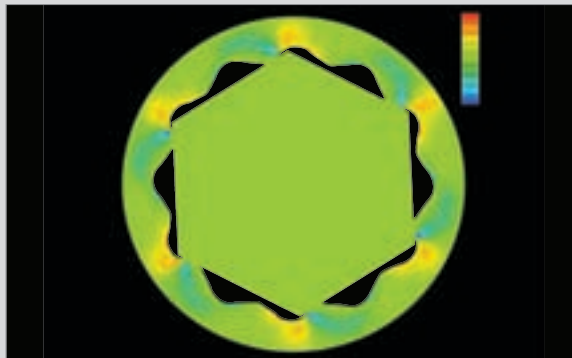

#5 SPLINE DRIVE IMPACT SOCKETS - 6 POINT

- › Proto® 6 Point Impact Sockets are ideal for use on stubborn or damaged fasteners, and also on fasteners made from soft materials.
- › TorquePlus™ features apply.



| Product # | Size (in) (A) | Nut End Outside Dia. (in) (B) | Drive End Outside Dia. (in) (C) | Nut Depth (in) (D) | Bolt Clearance Depth (in) (E) | Overall Length (in) (L) | Weight (lbs) |
|-----------|---------------|-------------------------------|---------------------------------|--------------------|-------------------------------|-------------------------|--------------|
| J09915 | 15/16 | 1-5/8 | 2-3/8 | 19/32 | 1-1/2 | 3 | 1.94 |
| J09916 | 1 | 1-11/16 | 2-3/8 | 5/8 | 1-1/2 | 3-1/8 | 1.91 |
| J09917 | 1-1/16 | 1-11/16 | 2-3/8 | 43/64 | 1-1/2 | 3-1/8 | 1.92 |
| J09918 | 1-1/8 | 1-7/8 | 2-3/8 | 23/32 | 1-1/2 | 3-1/4 | 2.09 |
| J09919 | 1-3/16 | 1-7/8 | 2-3/8 | 3/4 | 1-1/2 | 3-1/4 | 2.10 |
| J09920 | 1-1/4 | 2-3/8 | 2-3/8 | 25/32 | 1-1/2 | 3-1/4 | 2.21 |
| J09921 | 1-5/16 | 2-3/8 | 2-3/8 | 53/64 | 1-5/8 | 3-1/4 | 2.23 |
| J09922 | 1-3/8 | 2-3/8 | 2-3/8 | 55/64 | 1-5/8 | 3-3/8 | 2.23 |
| J09923 | 1-7/16 | 2-1/2 | 2-3/8 | 29/32 | 29/32 | 3-3/8 | 2.43 |
| J09924 | 1-1/2 | 2-1/2 | 2-3/8 | 15/16 | 15/16 | 3-3/8 | 2.46 |
| J09925 | 1-9/16 | 2-3/4 | 2-3/8 | 63/64 | 63/64 | 3-1/2 | 2.69 |
| J09926 | 1-5/8 | 2-3/4 | 2-3/8 | 1-1/64 | 1-1/64 | 3-5/8 | 2.94 |
| J09927 | 1-11/16 | 2-15/16 | 2-3/8 | 1-27/64 | 2-1/8 | 3-5/8 | 2.95 |
| J09928 | 1-3/4 | 2-15/16 | 2-3/8 | 1-7/64 | 1-27/64 | 3-47/64 | 3.11 |
| J09929 | 1-13/16 | 3-1/8 | 2-3/8 | 1-1/8 | 1-27/64 | 3-7/16 | 3.27 |
| J09930 | 1-7/8 | 3-1/8 | 2-3/8 | 1-3/16 | 1-1/2 | 3-17/32 | 3.25 |
| J09931 | 1-15/16 | 3-1/8 | 2-3/8 | 1-1/4 | 1-1/2 | 3-17/32 | 3.43 |
| J09932 | 2 | 3-1/4 | 2-3/8 | 1-1/4 | 1-15/32 | 3-17/32 | 3.66 |
| J09933 | 2-1/16 | 3-1/4 | 2-3/8 | 1-19/32 | 2-1/8 | 4 | 3.89 |
| J09934 | 2-1/8 | 3-1/2 | 2-3/8 | 1-37/64 | 2-1/8 | 3-11/16 | 4.63 |
| J09935 | 2-3/16 | 3-1/2 | 2-3/8 | 1-3/8 | 1-39/64 | 3-3/4 | 4.28 |
| J09936 | 2-1/4 | 3-1/2 | 2-3/8 | 1-1/2 | 1-23/32 | 4-3/16 | 4.52 |
| J09937 | 2-5/16 | 3-1/2 | 2-3/8 | 1-23/32 | 2-7/16 | 3-57/64 | 4.44 |
| J09938 | 2-3/8 | 3-3/4 | 2-3/8 | 1-11/16 | 2-7/16 | 3-57/64 | 4.80 |
| J09939 | 2-7/16 | 3-3/4 | 2-3/8 | 1-25/32 | 2-13/16 | 4 | 5.29 |
| J09940 | 2-1/2 | 3-3/4 | 2-3/8 | 1-53/64 | 2-13/16 | 4-3/8 | 5.11 |
| J09941 | 2-9/16 | 3-3/4 | 2-3/8 | 1-5/8 | 1-55/64 | 4-3/8 | 6.45 |
| J09942 | 2-5/8 | 4-1/8 | 2-3/8 | 1-59/64 | 2-13/16 | 4-1/2 | 6.68 |
| J09944 | 2-3/4 | 4-1/4 | 2-3/8 | 1-3/4 | 1-59/64 | 4-1/4 | 6.89 |
| J09947 | 2-15/16 | 4-1/2 | 2-3/8 | 2-5/32 | 3 | 4-13/16 | 8.22 |
| J09948 | 3 | 4-1/2 | 2-3/8 | 2 | 2-13/64 | 4-39/64 | 7.93 |
| J09950 | 3-1/8 | 4-3/4 | 2-3/8 | 2 | 2-13/64 | 4-39/64 | 7.95 |



#5 SPLINE DRIVE IMPACT ADAPTERS - MALE SQUARE

- › Use adapters to help increase or decrease drive end size.
- › Do not use hand adapters with power tools.
- › Do not over torque small sockets when using them with adapters on large drive tools.



| Product # | Size (in) | Overall Length (in) (L) | Weight (lbs) |
|-----------|--------------------------|-------------------------|--------------|
| J09902 | #5 SPL. F x 1" Sq. M | 4-3/8 | 2.16 |
| J09904 | #5 SPL. F x 1-1/2" Sq. M | 5 | 2.74 |



#5 SPLINE DRIVE BUDD WHEEL DEEP IMPACT SOCKET

- › Proto® 6 Point Impact Sockets are ideal for use on stubborn or damaged fasteners, and also on fasteners made from soft materials.
- › TorquePlus™ features apply.



| Product # | Size (in) (A) | Nut End Outside Dia. (in) (B) | Drive End Outside Dia. (in) (C) | Overall Length (in) (L) | Weight (lbs) |
|-----------|---------------|-------------------------------|---------------------------------|-------------------------|--------------|
| J09924-LS | 1-1/2 | 2-3/8 | 2-3/8 | 4-3/16 | 3.10 |

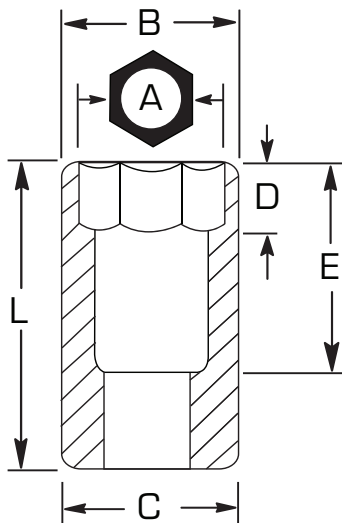

1/4" DRIVE HIGH STRENGTH MAGNETIC POWER SOCKETS - 6 POINT

- › ProtoGrip™ Magnetic Sockets use high-strength magnets made from a rare earth magnet alloy/nylon blend.
- › ProtoGrip™ Magnetic Sockets require no bushings to hold the magnet in place. Allows room for more magnet material, helping increase total magnetic strength.
- › Designed to easily pick up heavy fasteners and hold them tightly during use.
- › Strong magnetic hold helps increase efficiency when installing fasteners in awkward or hard-to-reach locations.
- › Power sockets with high surface hardness are used in high-speed assembly operations. Ideal for nut runners.
- › Socket size stamped on tool for easy identification.
- › Side locking hole.



| Product # | Size (in) (A) | Nut End Outside Dia. (in) (B) | Drive End Outside Dia. (in) (C) | Nut Depth (in) (D) | Overall Length (in) (L) | Weight (lbs) |
|-----------|---------------|-------------------------------|---------------------------------|--------------------|-------------------------|--------------|
| J6906PF | 3/16 | 5/16 | 1/2 | 5/32 | 7/8 | 0.03 |
| J6908PF | 1/4 | 25/64 | 1/2 | 11/64 | 7/8 | 0.03 |
| J6910PF | 5/16 | 1/2 | 1/2 | 13/64 | 15/16 | 0.04 |
| J6911PF | 11/32 | 33/64 | 33/64 | 7/32 | 15/16 | 0.04 |
| J6912PF | 3/8 | 9/16 | 9/16 | 15/64 | 15/16 | 0.05 |
| J6914PF | 7/16 | 21/32 | 21/32 | 1/4 | 1 | 0.07 |
| J6916PF | 1/2 | 11/16 | 11/16 | 1/4 | 1 | 0.08 |



ASME B107.2

1/4" DRIVE METRIC HIGH STRENGTH MAGNETIC POWER SOCKETS - 6 POINT

METRIC

- › ProtoGrip™ Magnetic Sockets use high-strength magnets made from a rare earth magnet alloy/nylon blend.
- › ProtoGrip™ Magnetic Sockets require no bushings to hold the magnet in place. Allows room for more magnet material, helping increase total magnetic strength.
- › Designed to easily pick up heavy fasteners and hold them tightly during use.
- › Strong magnetic hold helps increase efficiency when installing fasteners in awkward or hard-to-reach locations.
- › Socket size stamped on tool for easy identification.
- › Side locking hole.
- › Power sockets with high surface hardness are used in high-speed assembly operations. Ideal for nut runners.



| Product # | Size (mm) (A) | Nut End Outside Dia. (in) (B) | Drive End Outside Dia. (in) (C) | Nut Depth (in) (D) | Overall Length (in) (L) | Weight (lbs) |
|-----------|---------------|-------------------------------|---------------------------------|--------------------|-------------------------|--------------|
| J6905MPF | 5 | 5/16 | 1/2 | 5/32 | 7/8 | 0.03 |
| J69055MPF | 5.5 | 23/64 | 1/2 | 5/32 | 7/8 | 0.03 |
| J6906MPF | 6 | 25/64 | 1/2 | 11/64 | 7/8 | 0.03 |
| J6907MPF | 7 | 7/16 | 1/2 | 11/64 | 15/16 | 0.04 |
| J6908MPF | 8 | 1/2 | 1/2 | 11/64 | 15/16 | 0.04 |
| J6909MPF | 9 | 33/64 | 33/64 | 13/64 | 15/16 | 0.04 |
| J6910MPF | 10 | 9/16 | 9/16 | 7/32 | 15/16 | 0.05 |
| J6911MPF | 11 | 5/8 | 5/8 | 17/64 | 1 | 0.06 |
| J6912MPF | 12 | 11/16 | 11/16 | 9/32 | 1 | 0.08 |
| J6913MPF | 13 | 47/64 | 47/64 | 19/64 | 1 | 0.09 |



ASME B107.33



3/8" DRIVE HIGH STRENGTH MAGNETIC POWER SOCKETS - 6 POINT

- ▶ ProtoGrip™ Magnetic Sockets use high-strength magnets made from a rare earth magnet alloy/nylon blend.
- ▶ ProtoGrip™ Magnetic Sockets require no bushings to hold the magnet in place. This allows room for more magnet material, helping increase total magnetic strength.
- ▶ Designed to easily pick up heavy fasteners and hold them tightly during use.
- ▶ Strong magnetic hold helps increase efficiency when installing fasteners in awkward or hard-to-reach locations.
- ▶ Power sockets with high surface hardness are used in high-speed assembly operations. Ideal for nut runners.



| Product # | Size (in) (A) | Nut End Outside Dia. (in) (B) | Drive End Outside Dia. (in) (C) | Nut Depth (in) (D) | Overall Length (in) (L) | Weight (lbs) |
|-----------|---------------|-------------------------------|---------------------------------|--------------------|-------------------------|--------------|
| J7210PF | 5/16 | 1/2 | 11/16 | 3/16 | 1-3/32 | 0.08 |
| J7212PF | 3/8 | 39/64 | 11/16 | 15/64 | 1-3/32 | 0.09 |
| J7214PF | 7/16 | 11/16 | 11/16 | 1/4 | 1-3/16 | 0.08 |
| J7216PF | 1/2 | 3/4 | 3/4 | 9/32 | 1-3/16 | 0.10 |
| J7218PF | 9/16 | 13/16 | 13/16 | 21/64 | 1-3/16 | 0.11 |



ASME B107.2

3/8" DRIVE METRIC HIGH STRENGTH MAGNETIC POWER SOCKETS - 6 POINT



- ▶ ProtoGrip™ Magnetic Sockets use high-strength magnets made from a rare earth magnet alloy/nylon blend.
- ▶ ProtoGrip™ Magnetic Sockets require no bushings to hold the magnet in place. This allows room for more magnet material, helping increase total magnetic strength.
- ▶ Designed to easily pick up heavy fasteners and hold them tightly during use.
- ▶ Strong magnetic hold helps increase efficiency when installing fasteners in awkward or hard-to-reach locations.
- ▶ Power sockets with high surface hardness are used in high-speed assembly operations. Ideal for nut runners.



| Product # | Size (mm) (A) | Nut End Outside Dia. (in) (B) | Drive End Outside Dia. (in) (C) | Nut Depth (in) (D) | Overall Length (in) (L) | Weight (lbs) |
|-----------|---------------|-------------------------------|---------------------------------|--------------------|-------------------------|--------------|
| J7207MPF | 7 | 31/64 | 11/16 | 11/64 | 1-3/32 | 0.08 |
| J7208MPF | 8 | 1/2 | 11/16 | 7/32 | 1-3/32 | 0.07 |
| J7210MPF | 10 | 5/8 | 11/16 | 7/32 | 1-9/64 | 0.08 |
| J7211MPF | 11 | 11/16 | 11/16 | 17/64 | 1-9/64 | 0.08 |
| J7212MPF | 12 | 47/64 | 47/64 | 9/32 | 1-9/64 | 0.10 |
| J7213MPF | 13 | 3/4 | 3/4 | 19/64 | 1-13/64 | 0.10 |
| J7215MPF | 15 | 55/64 | 55/64 | 21/64 | 1-13/64 | 0.14 |



ASME B107.33M

1/2" DRIVE HIGH STRENGTH MAGNETIC POWER SOCKETS - 6 POINT

- ▶ ProtoGrip™ Magnetic Sockets use high-strength magnets made from a rare earth magnet alloy/nylon blend.
- ▶ ProtoGrip™ Magnetic Sockets require no bushings to hold the magnet in place. This allows room for more magnet material, helping increase total magnetic strength.
- ▶ Designed to easily pick up heavy fasteners and hold them tightly during use.
- ▶ Strong magnetic hold helps increase efficiency when installing fasteners in awkward or hard-to-reach locations.
- ▶ Power sockets with high surface hardness are used in high-speed assembly operations. Ideal for nut runners.



| Product # | Size (in) (A) | Nut End Outside Dia. (in) (B) | Drive End Outside Dia. (in) (C) | Nut Depth (in) (D) | Overall Length (in) (L) | Weight (lbs) |
|-----------|---------------|-------------------------------|---------------------------------|--------------------|-------------------------|--------------|
| J7412PF | 3/8 | 47/64 | 15/16 | 15/16 | 1-1/2 | 0.18 |
| J7414PF | 7/16 | 47/64 | 15/16 | 1/4 | 1-1/2 | 0.18 |
| J7416PF | 1/2 | 51/64 | 15/16 | 17/64 | 1-1/2 | 0.20 |
| J7418PF | 9/16 | 15/16 | 15/16 | 21/64 | 1-1/2 | 0.20 |



ASME B107.2



PROTO

IF YOU FIND YOURSELF SECOND-GUESSING YOUR TORQUE WRENCH, FIND A NEW TORQUE WRENCH.

You simply can't hope that a bolt holding a rotor blade on an Apache helicopter is properly tightened.

Or that a nut keeping a conveyor running smoothly is secured. You have to know they are. At Proto[®],

our wrench parts are manufactured from high-grade steel. Key working components are heat-treated

to resist wear. Springs are manufactured to keep their shape for thousands of cycles. And assembly

is done on a work bench, by hand. We even offer three product series to fit any tolerance ranges from

automotive to commercial air. All this ensures durable, dependable accuracy. Anything less is intolerable.

PRECISION TORQUE

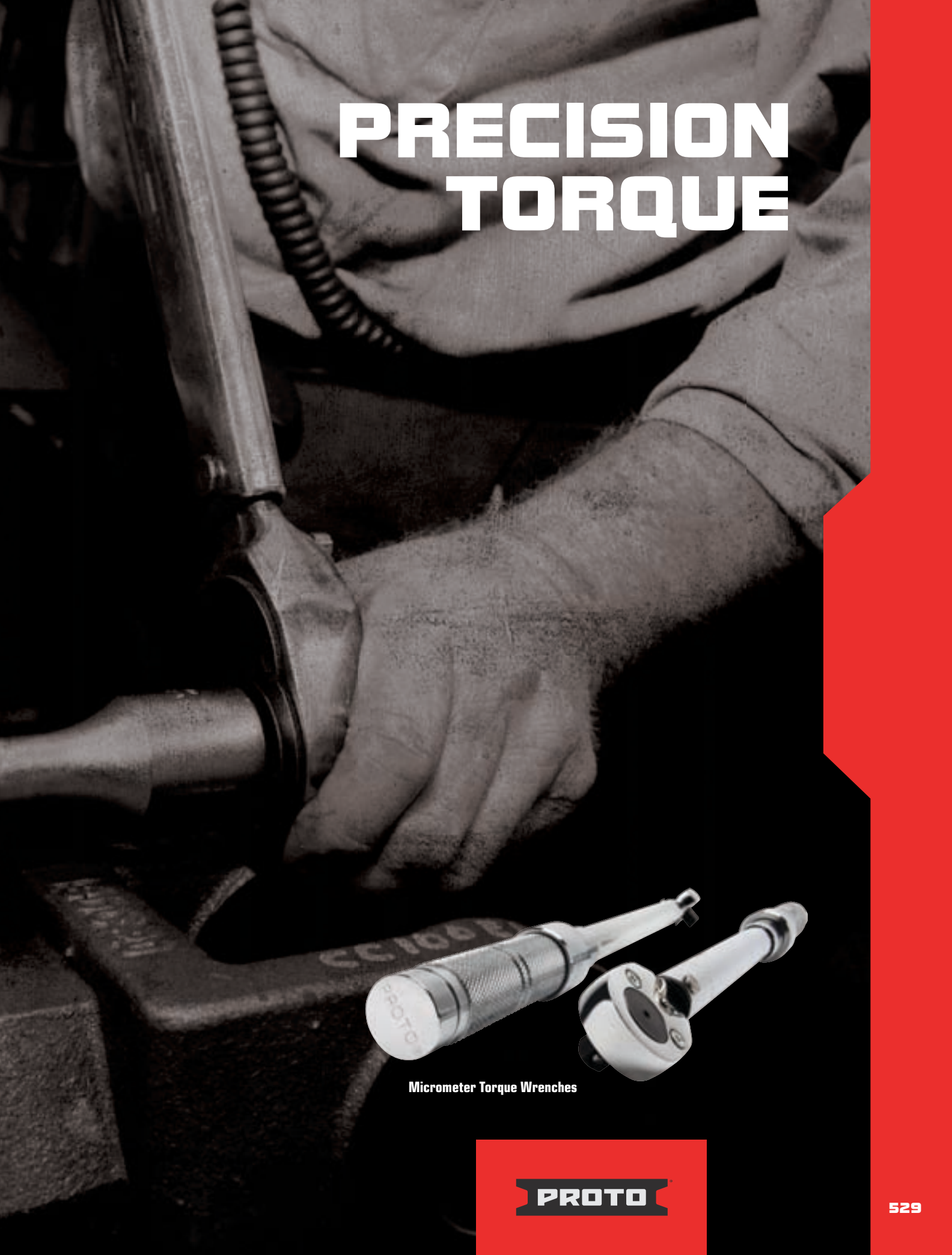

Micrometer Torque Wrenches





INTERCHANGEABLE HEAD TORQUE SYSTEM

- › Manufactured from a solid piece of steel.
- › No welds or cuts to compromise the integrity of the attachment.

In the Proto® IHTW System, the handles and the attachments are engineered by the same team, and manufactured to a precise spec so that the centerline distances of each tang size remain the same, from one attachment to another, from one piece to the next. Proto® can deliver a high degree of consistency and repeatability from tool to tool and job to job.

Each attachment, for a given tang size, has the same centerline distance, so the wrench can use the same torque calculation regardless of the attachment.



Each size is manufactured from a single piece of steel and engineered specifically to that size.



TANG SIZES

Tang sizes are similar to Drive Sizes for Ratchets:
 H4 Tang = 1/4" Drive
 H5 Tang = 3/8" Drive
 H7 Tang = 1/2" Drive



H4 TANG



H5 TANG



H7 TANG

SYSTEM CENTERLINE DISTANCES ARE KEY

Each attachment for a given tang size is specifically engineered to maintain the System Centerline Distance - a fresh design, engineered to work smoothly as part of the whole system. No tool has a weld to throw off the centerline distance. Only when the piece is manufactured from a single piece of steel can the System Centerline Distance be reliably and accurately maintained.

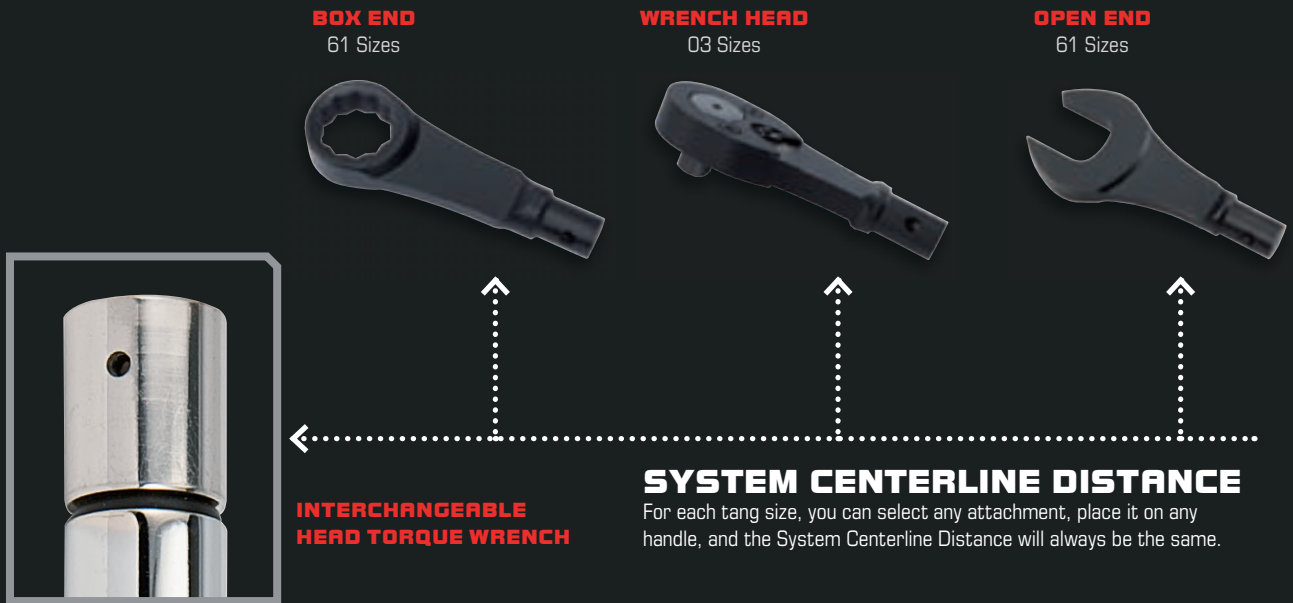

INTERCHANGEABLE HEAD TORQUE WRENCH HANDLE

- › Electronic Torque Wrenches offer the highest level of precision.
- › We offer a range of pre-set torque wrenches from 50 ft-lbs. to 200 ft-lbs. for dedicated applications.



ELECTRONIC INTERCHANGEABLE HEAD TORQUE WRENCH ASSEMBLIES

- › Full interface with Proto® Interchangeable Head Attachments.
- › Accuracy of +/- 2% of indicated value in both clockwise and counter clockwise directions.
- › Broad accuracy range extends from 10% to 100% of Full Scale to help reduce the number of torque wrenches required.
- › Ninety-nine "on-board" memory storage locations help improve efficiency when taking multiple torque readings.
- › Three units of measure are available (Ft-lb, In-lb, and Nm).
- › Three operating modes: Track Mode, Peak Hold and Auto Clear.
- › Fast sampling rate helps maintain high accuracy during torque applications.
- › Torque wrench head rotates to allow for easy viewing of LCD display.
- › Easy to read LCD Display with large digits.
- › 3-way Red/Green/Yellow lights.
- › Yellow light appears at the low end of the zone.
- › Green light appears and buzzer sounds when the target is reached.
- › Red light appears with intermittent buzzer when it is over torqued.
- › Audible buzzer helps identify when desired torque target zones are approaching and met.
- › Target torque zone is adjustable from 1% to 10% of targeted torque value.



| Product # | Drive Size (in) | Torque Range (ft-lbs) | Torque Range (in-lbs) | Torque Range (Nm) | Increments (ft-lbs) | Increments (in-lbs) | Increments (Nm) | Width (in) | Height (in) | Overall Length (in) | Weight (lbs) |
|-----------|-----------------|-----------------------|-----------------------|-------------------|---------------------|---------------------|-----------------|------------|-------------|---------------------|--------------|
| JH4-250 | 1/4 | 2.1-20.8 | 25-250 | 2.8-28.2 | 0.01 | 0.1 | 0.01 | 1-3/4 | 2 | 17-1/4 | 2.20 |
| JH5-100F | 3/8 | 10-100 | 120-1200 | 13.6-135.6 | 0.1 | 1 | 0.1 | 1-3/4 | 2 | 17-1/4 | 2.40 |
| JH7-250F | 1/2 | 25-250 | 300-3000 | 33.9-338.9 | 0.1 | 1 | 0.1 | 1-3/4 | 2 | 23 | 3.00 |

MICROMETER INTERCHANGEABLE HEAD TORQUE WRENCH ASSEMBLIES

- › Full interface with Proto® Interchangeable Head Attachments.
- › Accuracy of +/-4% CW and +/-6% CCW.
- › Two sizes available.



| Product # | Drive Size (in) | Torque Range (ft-lbs) | Increments (ft-lbs) | Width (in) | Height (in) | Overall Length (in) | Weight (lbs) |
|-----------|-----------------|-----------------------|---------------------|------------|-------------|---------------------|--------------|
| JH5-6006C | 3/8 | 16-80 | 0.5 | 1-1/4 | 1-1/4 | 15 | 2.50 |
| JH7-6014C | 1/2 | 50-250 | 1 | 1-1/2 | 1-1/2 | 26 | 4.70 |

PRE-SET INTERCHANGEABLE HEAD TORQUE WRENCH ASSEMBLIES

- › Full interface with Proto® Interchangeable Head Attachments.
- › Accuracy of +/-4% CW and +/-6% CCW.
- › Pre-set for fixed and repeatable torque applications.
- › Click-type operation for audible click.
- › Soft, comfortable grip.



| Product # | Torque Range (ft-lbs) | Torque Range (in-lbs) | Width (in) | Height (in) | Overall Length (in) | Weight (lbs) |
|------------|-----------------------|-----------------------|------------|-------------|---------------------|--------------|
| JH4-150PS | - | 50-150 | 1-1/2 | 1-1/2 | 6 | 0.70 |
| JH4-50FPS | 10-50 | - | 1-1/2 | 1-1/2 | 11 | 1.30 |
| JH5-150FPS | 45-150 | - | 1-1/2 | 1-1/2 | 19-1/4 | 2.25 |
| JH5-200FPS | 45-200 | - | 1-1/2 | 1-1/2 | 23-1/4 | 2.30 |

1/4" DRIVE RATCHET TORQUE WRENCH HEAD - H4 TANG

- › Fixed ratcheting head with a robust 24-tooth design with 15° arc swing.
- › Alloy steel drive gear for strength and durability.
- › Low profile for easy access.
- › Reversing lever design for quick, one-hand operation.



| Product # | Drive Size (in) | Width (in) | Height (in) | Overall Length (in) | Weight (lbs) |
|-----------|-----------------|------------|-------------|---------------------|--------------|
| JH4-14R | 1/4 | 1-1/16 | 23/32 | 3-1/4 | 0.20 |

Use With: JH4-250, JH4-150PS, JH4-50FPS

OPEN END TORQUE WRENCH HEADS - H4 TANG

- › Open end is angled to 15° to help keep shank clear of obstructions helping to improve access.



| Product # | Size (in) | Size (mm) | Width (in) | Height (in) | Overall Length (in) | Weight (lbs) |
|----------------|-----------|-----------|------------|-------------|---------------------|--------------|
| JH4-12 | 3/8 | – | 27/32 | 7/16 | 3-1/16 | 0.08 |
| JH4-14 | 7/16 | – | 15/16 | 7/16 | 3-1/32 | 0.09 |
| JH4-16 | 1/2 | – | 1-1/16 | 7/16 | 3-3/32 | 0.11 |
| JH4-18 | 9/16 | – | 1-7/32 | 7/16 | 3-5/32 | 0.13 |
| JH4-10M | – | 10 | 27/32 | 7/16 | 3-1/16 | 0.08 |
| JH4-11M | – | 11 | 15/16 | 7/16 | 3-1/32 | 0.09 |
| JH4-12M | – | 12 | 1-1/32 | 7/16 | 3-1/16 | 0.10 |
| JH4-13M | – | 13 | 1-1/16 | 7/16 | 3-3/32 | 0.11 |
| JH4-14M | – | 14 | 1-7/32 | 7/16 | 3-5/32 | 0.13 |



Use With: JH4-250, JH4-150PS, JH4-50FPS

BOX END TORQUE WRENCH HEADS - H4 TANG

- › The Proto® TorquePlus™ Design, a high performance drive configuration which allows for quick and easy wrench engagement with the fastener flats, not the corners.
- › 12 point box end allows for fine indexing, helping to improve speed and access.
- › Fits 4, 6 and 12 point fasteners.
- › Indexed to 7.5° to help keep shank clear of obstructions by allowing the user to flip the wrench over to continue turning the fastener.
- › Countersunk on both sides to allow for easy application to the fastener.



| Product # | Size (in) | Size (mm) | Width (in) | Height (in) | Overall Length (in) | Weight (lbs) |
|-----------------|-----------|-----------|------------|-------------|---------------------|--------------|
| JH4-12B | 3/8 | – | 19/32 | 7/16 | 3-1/32 | 0.08 |
| JH4-14B | 7/16 | – | 21/32 | 7/16 | 3-1/16 | 0.08 |
| JH4-16B | 1/2 | – | 25/32 | 7/16 | 3-1/8 | 0.11 |
| JH4-18B | 9/16 | – | 27/32 | 7/16 | 3-5/32 | 0.12 |
| JH4-10MB | – | 10 | 19/32 | 7/16 | 3-1/32 | 0.07 |
| JH4-11MB | – | 11 | 21/32 | 7/16 | 3-1/16 | 0.08 |
| JH4-12MB | – | 12 | 23/32 | 7/16 | 3-3/32 | 0.09 |
| JH4-13MB | – | 13 | 25/32 | 7/16 | 3-1/8 | 0.10 |
| JH4-14MB | – | 14 | 27/32 | 7/16 | 3-5/32 | 0.12 |



Use With: JH4-250, JH4-150PS, JH4-50FPS

3/8" DRIVE RATCHET TORQUE WRENCH HEAD - H5 TANG

- › Fixed ratcheting head with a robust 24-tooth design with 15° arc swing.
- › Alloy steel drive gear for strength and durability.
- › Low profile for easy access.
- › Reversing lever design for quick, one-hand operation.



| Product # | Drive Size (in) | Width (in) | Height (in) | Overall Length (in) | Weight (lbs) |
|----------------|-----------------|------------|-------------|---------------------|--------------|
| JH5-38R | 3/8 | 1-7/16 | 1 | 4-3/32 | 0.47 |



Use With: JH5-100F, JH5-6006C, JH5-150FPS, JH5-200FPS

OPEN END TORQUE WRENCH HEADS - H5 TANG

- Open end is angled to 15° to help keep shank clear of obstructions helping to improve access.



| Product # | Size (in) | Size (mm) | Width (in) | Height (in) | Overall Length (in) | Weight (lbs) |
|-----------|-----------|-----------|------------|-------------|---------------------|--------------|
| JH5-14 | 7/16 | – | 15/16 | 5/8 | 3-21/32 | 0.14 |
| JH5-16 | 1/2 | – | 1-1/16 | 5/8 | 3-3/4 | 0.16 |
| JH5-18 | 9/16 | – | 1-7/32 | 5/8 | 3-13/16 | 0.18 |
| JH5-20 | 5/8 | – | 1-5/16 | 5/8 | 3-27/32 | 0.21 |
| JH5-22 | 11/16 | – | 1-7/16 | 5/8 | 3-7/8 | 0.23 |
| JH5-24 | 3/4 | – | 1-19/32 | 5/8 | 3-15/16 | 0.27 |
| JH5-26 | 13/16 | – | 1-23/32 | 5/8 | 3-31/32 | 0.31 |
| JH5-28 | 7/8 | – | 1-27/32 | 5/8 | 4 | 0.34 |
| JH5-11M | – | 11 | 15/16 | 5/8 | 3-21/32 | 0.14 |
| JH5-12M | – | 12 | 1-1/32 | 5/8 | 3-23/32 | 0.15 |
| JH5-13M | – | 13 | 1-1/16 | 5/8 | 3-3/4 | 0.16 |
| JH5-14M | – | 14 | 1-7/32 | 5/8 | 3-13/16 | 0.18 |
| JH5-15M | – | 15 | 1-1/4 | 5/8 | 3-13/16 | 0.19 |
| JH5-16M | – | 16 | 1-5/16 | 5/8 | 3-27/32 | 0.21 |
| JH5-17M | – | 17 | 1-7/16 | 5/8 | 3-7/8 | 0.23 |
| JH5-18M | – | 18 | 1-1/2 | 5/8 | 3-29/32 | 0.25 |
| JH5-19M | – | 19 | 1-19/32 | 5/8 | 3-15/16 | 0.27 |
| JH5-20M | – | 20 | 1-5/8 | 5/8 | 3-15/16 | 0.28 |
| JH5-21M | – | 21 | 1-23/32 | 5/8 | 3-31/32 | 0.31 |
| JH5-22M | – | 22 | 1-27/32 | 5/8 | 4 | 0.34 |
| JH5-23M | – | 23 | 1-29/32 | 5/8 | 4-1/16 | 0.38 |



Use With: JH5-100F, JH5-6006C, JH5-150FPS, JH5-200FPS

BOX END TORQUE WRENCH HEADS - H5 TANG

- The Proto® TorquePlus™ Design, a high performance drive configuration which allows for quick and easy wrench engagement with the fastener flats, not the corners.
- 12 point box end allows for fine indexing, helping to improve speed and access.
- Fits 4, 6 and 12 point fasteners.
- Indexed to 7.5° to help keep shank clear of obstructions by allowing the user to flip the wrench over to continue turning the fastener.
- Countersunk on both sides to allow for easy application to the fastener.



| Product # | Size (in) | Size (mm) | Width (in) | Height (in) | Overall Length (in) | Weight (lbs) |
|-----------|-----------|-----------|------------|-------------|---------------------|--------------|
| JH5-14B | 7/16 | – | 21/32 | 5/8 | 3-23/32 | 0.13 |
| JH5-16B | 1/2 | – | 25/32 | 5/8 | 3-3/4 | 0.16 |
| JH5-18B | 9/16 | – | 27/32 | 5/8 | 3-25/32 | 0.17 |
| JH5-20B | 5/8 | – | 15/16 | 5/8 | 3-27/32 | 0.20 |
| JH5-22B | 11/16 | – | 1 | 5/8 | 3-7/8 | 0.22 |
| JH5-24B | 3/4 | – | 1-1/8 | 5/8 | 3-15/16 | 0.25 |
| JH5-26B | 13/16 | – | 1-3/16 | 5/8 | 3-31/32 | 0.28 |
| JH5-28B | 7/8 | – | 1-9/32 | 5/8 | 4 | 0.31 |
| JH5-11MB | – | 11 | 21/32 | 5/8 | 3-23/32 | 0.13 |
| JH5-12MB | – | 12 | 23/32 | 5/8 | 3-23/32 | 0.14 |
| JH5-13MB | – | 13 | 25/32 | 5/8 | 3-3/4 | 0.16 |
| JH5-14MB | – | 14 | 27/32 | 5/8 | 3-25/32 | 0.17 |
| JH5-15MB | – | 15 | 7/8 | 5/8 | 3-13/16 | 0.18 |
| JH5-16MB | – | 16 | 15/16 | 5/8 | 3-27/32 | 0.20 |
| JH5-17MB | – | 17 | 1 | 5/8 | 3-7/8 | 0.22 |
| JH5-18MB | – | 18 | 1-1/16 | 5/8 | 3-29/32 | 0.23 |
| JH5-19MB | – | 19 | 1-1/8 | 5/8 | 3-15/16 | 0.25 |
| JH5-20MB | – | 20 | 1-5/32 | 5/8 | 3-31/32 | 0.27 |
| JH5-21MB | – | 21 | 1-3/16 | 5/8 | 3-31/32 | 0.28 |
| JH5-22MB | – | 22 | 1-9/32 | 5/8 | 4 | 0.31 |
| JH5-23MB | – | 23 | 1-11/32 | 5/8 | 4-1/16 | 0.36 |



Use With: JH5-100F, JH5-6006C, JH5-150FPS, JH5-200FPS



1/2" DRIVE RATCHET TORQUE WRENCH HEAD - H7 TANG

- › Fixed ratcheting head with a robust 24-tooth design with 15° arc swing.
- › Alloy steel drive gear for strength and durability.
- › Low profile for easy access.
- › Reversing lever design for quick, one-hand operation.



| Product # | Drive Size (in) | Width (in) | Height (in) | Overall Length (in) | Weight (lbs) |
|----------------|-----------------|------------|-------------|---------------------|--------------|
| JH7-12R | 1/2 | 1-27/32 | 1-13/32 | 5-7/8 | 1.08 |



Use With: JH7-250F, JH7-6014C

OPEN END TORQUE WRENCH HEADS - H7 TANG

- › Open end is angled to 15° to help keep shank clear of obstructions helping to improve access.



| Product # | Size (in) | Size (mm) | Width (in) | Height (in) | Overall Length (in) | Weight (lbs) |
|----------------|-----------|-----------|------------|-------------|---------------------|--------------|
| JH7-18 | 9/16 | – | 1-7/32 | 13/16 | 5-3/8 | 0.32 |
| JH7-20 | 5/8 | – | 1-5/16 | 13/16 | 5-13/32 | 0.35 |
| JH7-22 | 11/16 | – | 1-7/16 | 13/16 | 5-7/16 | 0.38 |
| JH7-24 | 3/4 | – | 1-19/32 | 13/16 | 5-1/2 | 0.42 |
| JH7-26 | 13/16 | – | 1-23/32 | 13/16 | 5-17/32 | 0.48 |
| JH7-28 | 7/8 | – | 1-27/32 | 13/16 | 5-9/16 | 0.51 |
| JH7-30 | 15/16 | – | 1-31/32 | 13/16 | 5-5/8 | 0.57 |
| JH7-32 | 1 | – | 2-3/32 | 13/16 | 5-21/32 | 0.64 |
| JH7-34 | 1-1/16 | – | 2-7/32 | 13/16 | 5-23/32 | 0.71 |
| JH7-36 | 1-1/8 | – | 2-11/32 | 13/16 | 5-25/32 | 0.79 |
| JH7-38 | 1-3/16 | – | 2-7/16 | 13/16 | 5-27/32 | 0.84 |
| JH7-40 | 1-1/4 | – | 2-9/16 | 13/16 | 5-27/32 | 0.93 |
| JH7-42 | 1-5/16 | – | 2-21/32 | 13/16 | 5-29/32 | 0.97 |
| JH7-44 | 1-3/8 | – | 2-13/16 | 13/16 | 5-15/16 | 1.08 |
| JH7-15M | – | 15 | 1-1/4 | 13/16 | 5-3/8 | 0.33 |
| JH7-16M | – | 16 | 1-5/16 | 13/16 | 5-13/32 | 0.35 |
| JH7-17M | – | 17 | 1-7/16 | 13/16 | 5-7/16 | 0.38 |
| JH7-18M | – | 18 | 1-1/2 | 13/16 | 5-15/32 | 0.40 |
| JH7-19M | – | 19 | 1-19/32 | 13/16 | 5-1/2 | 0.42 |
| JH7-20M | – | 20 | 1-5/8 | 13/16 | 5-1/2 | 0.45 |
| JH7-21M | – | 21 | 1-23/32 | 13/16 | 5-17/32 | 0.48 |
| JH7-22M | – | 22 | 1-27/32 | 13/16 | 5-9/16 | 0.51 |
| JH7-23M | – | 23 | 1-29/32 | 13/16 | 5-5/8 | 0.56 |
| JH7-24M | – | 24 | 1-31/32 | 13/16 | 5-5/8 | 0.57 |
| JH7-25M | – | 25 | 2-3/32 | 13/16 | 5-21/32 | 0.64 |
| JH7-26M | – | 26 | 2-5/32 | 13/16 | 5-21/32 | 0.65 |
| JH7-27M | – | 27 | 2-7/32 | 13/16 | 5-23/32 | 0.71 |
| JH7-28M | – | 28 | 2-7/32 | 13/16 | 5-25/32 | 0.70 |
| JH7-29M | – | 29 | 2-11/32 | 13/16 | 5-25/32 | 0.79 |
| JH7-30M | – | 30 | 2-7/16 | 13/16 | 5-27/32 | 0.84 |
| JH7-32M | – | 32 | 2-9/16 | 13/16 | 5-27/32 | 0.93 |



Use With: JH7-250F, JH7-6014C

BOX END TORQUE WRENCH HEADS - H7 TANG

- › The Proto® TorquePlus™ Design, a high performance drive configuration which allows for quick and easy wrench engagement with the fastener flats, not the corners.
- › 12 point box end allows for fine indexing, helping to improve speed and access.
- › Fits 4, 6 and 12 point fasteners.
- › Indexed to 7.5° to help keep shank clear of obstructions by allowing the user to flip the wrench over to continue turning the fastener.
- › Countersunk on both sides to allow for easy application to the fastener.



| Product # | Size (in) | Size (mm) | Width (in) | Height (in) | Overall Length (in) | Weight (lbs) |
|-----------|-----------|-----------|------------|-------------|---------------------|--------------|
| JH7-18B | 9/16 | – | 27/32 | 13/16 | 5-11/32 | 0.31 |
| JH7-20B | 5/8 | – | 15/16 | 13/16 | 5-13/32 | 0.34 |
| JH7-22B | 11/16 | – | 1 | 13/16 | 5-7/16 | 0.36 |
| JH7-24B | 3/4 | – | 1-1/8 | 13/16 | 5-1/2 | 0.40 |
| JH7-26B | 13/16 | – | 1-3/16 | 13/16 | 5-17/32 | 0.45 |
| JH7-28B | 7/8 | – | 1-9/32 | 13/16 | 5-9/16 | 0.48 |
| JH7-30B | 15/16 | – | 1-3/8 | 13/16 | 5-5/8 | 0.55 |
| JH7-32B | 1 | – | 1-15/32 | 13/16 | 5-11/16 | 0.60 |
| JH7-34B | 1-1/16 | – | 1-17/32 | 13/16 | 5-23/32 | 0.66 |
| JH7-36B | 1-1/8 | – | 1-5/8 | 13/16 | 5-3/4 | 0.71 |
| JH7-38B | 1-3/16 | – | 1-3/4 | 13/16 | 5-13/16 | 0.80 |
| JH7-40B | 1-1/4 | – | 1-13/16 | 13/16 | 5-27/32 | 0.82 |
| JH7-42B | 1-5/16 | – | 1-29/32 | 13/16 | 5-29/32 | 0.91 |
| JH7-44B | 1-3/8 | – | 1-31/32 | 13/16 | 5-15/16 | 0.98 |
| JH7-15MB | – | 15 | 7/8 | 13/16 | 5-3/8 | 0.32 |
| JH7-16MB | – | 16 | 15/16 | 13/16 | 5-13/32 | 0.34 |
| JH7-17MB | – | 17 | 1 | 13/16 | 5-7/16 | 0.37 |
| JH7-18MB | – | 18 | 1-1/16 | 13/16 | 5-15/32 | 0.39 |
| JH7-19MB | – | 19 | 1-1/8 | 13/16 | 5-1/2 | 0.40 |
| JH7-20MB | – | 20 | 1-5/32 | 13/16 | 5-17/32 | 0.43 |
| JH7-21MB | – | 21 | 1-3/16 | 13/16 | 5-17/32 | 0.44 |
| JH7-22MB | – | 22 | 1-9/32 | 13/16 | 5-9/16 | 0.48 |
| JH7-23MB | – | 23 | 1-11/32 | 13/16 | 5-5/8 | 0.54 |
| JH7-24MB | – | 24 | 1-3/8 | 13/16 | 5-5/8 | 0.55 |
| JH7-25MB | – | 25 | 1-15/32 | 13/16 | 5-11/16 | 0.61 |
| JH7-26MB | – | 26 | 1-1/2 | 13/16 | 5-11/16 | 0.60 |
| JH7-27MB | – | 27 | 1-17/32 | 13/16 | 5-23/32 | 0.66 |
| JH7-28MB | – | 28 | 1-19/32 | 13/16 | 5-23/32 | 0.66 |
| JH7-29MB | – | 29 | 1-5/8 | 13/16 | 5-3/4 | 0.71 |
| JH7-30MB | – | 30 | 1-3/4 | 13/16 | 5-13/16 | 0.81 |
| JH7-32MB | – | 32 | 1-13/16 | 13/16 | 5-27/32 | 0.82 |



Use With: JH7-250F, JH7-6014C



FIXED HEAD MICROMETER TORQUE WRENCHES - IN-LBS MEETS ASME STANDARD

- › Calibrated to +/- 3% clockwise direction and +/- 6% and counter clockwise direction at 20% to 100% of full scale.
- › Calibration is accomplished by manual loading the torque wrenches.
- › Manufactured to meet standard industrial torque applications, general industry, heavy equipment, and maintenance.



| Product # | Drive Size (in) | Torque Range (in-lbs) | Increments (in-lbs) | Head Width (in) | Head Depth (in) | Overall Length (in) | Weight (lbs) | Storage Case |
|---------------|-----------------|-----------------------|---------------------|-----------------|-----------------|---------------------|--------------|--------------|
| J6061C | 1/4 | 40-200 | 1 | 25/32 | 3/4 | 11-45/64 | 2.60 | J6006PBF |
| J6063C | 3/8 | 40-200 | 1 | 25/32 | 7/8 | 11-45/64 | 2.60 | J6006PBF |
| J6065C | 3/8 | 200-1000 | 5 | 55/64 | 7/8 | 15-13/64 | 3.00 | J6006PBF |



ASME B107.14M

FIXED HEAD MICROMETER TORQUE WRENCHES - FT-LBS MEETS ASME STANDARD

- › Calibrated to +/- 3% in clockwise direction and +/- 6% counter clockwise direction at 20% to 100% of full scale.
- › Calibration is accomplished by manual loading the torque wrenches.
- › Manufactured to meet standard industrial torque applications, general industry, heavy equipment, and maintenance.



| Product # | Drive Size (in) | Torque Range (ft-lbs) | Increments (ft-lbs) | Head Width (in) | Head Depth (in) | Overall Length (in) | Weight (lbs) | Storage Case |
|---------------|-----------------|-----------------------|---------------------|-----------------|-----------------|---------------------|--------------|--------------|
| J6005C | 3/8 | 16-80 | 0.5 | 55/64 | 7/8 | 15-13/64 | 3.00 | J6006PBF |
| J6013C | 1/2 | 50-250 | 1 | 1-1/8 | 1-7/32 | 26-23/32 | 5.90 | J6014PBF |
| J6015C | 1/2 | 30-150 | 1 | 1-1/8 | 1-7/32 | 21-1/8 | 5.00 | J6014PBF |
| J6017B | 3/4 | 120-600 | 2 | 1-7/8 | 1-7/8 | 41-11/64 | 15.50 | J6007PB |



ASME B107.14M

FIXED HEAD MICROMETER TORQUE WRENCHES - IN-LBS MEETS T033K6 STANDARD

- › Calibrated to +/- 3% clockwise direction and +/- 6% counter clockwise direction.
- › Calibration is accomplished by mechanical loading of each wrench in a horizontal position, and performing a three click test at 20%, 60% and 100% of maximum instrument capacity.
- › Manufactured to meet precision/highly accurate applications such as military and aerospace.



| Product # | Drive Size (in) | Torque Range (in-lbs) | Increments (in-lbs) | Head Width (in) | Head Depth (in) | Overall Length (in) | Weight (lbs) | Storage Case |
|----------------|-----------------|-----------------------|---------------------|-----------------|-----------------|---------------------|--------------|--------------|
| J6061CX | 1/4 | 40-200 | 1 | 25/32 | 3/4 | 11-45/64 | 2.60 | J6006PBF |
| J6063CX | 3/8 | 40-200 | 1 | 25/32 | 7/8 | 11-45/64 | 2.60 | J6006PBF |
| J6065CX | 3/8 | 200-1000 | 5 | 55/64 | 7/8 | 15-13/64 | 3.00 | J6006PBF |



T033K6-4-2193-1

ASME B107.300

FIXED HEAD MICROMETER TORQUE WRENCHES - IN-LBS

MEETS T033K6 STANDARD WITH CERTIFICATION AND N.I.S.T. TRACEABILITY

- › Calibrated to +/- 3% in clockwise direction and +/- 6% in counter clockwise direction.
- › Calibration is accomplished by mechanical loading of each wrench in a horizontal position, and performing a three click test at 20%, 60% and 100% of maximum instrument capacity.
- › Certification documents traceable to N.I.S.T. (National Institute of Standards and Technology).
- › Manufactured to meet precision/highly accurate applications such as military and aerospace.



| Product # | Drive Size (in) | Torque Range (in-lbs) | Increments (in-lbs) | Head Width (in) | Head Depth (in) | Overall Length (in) | Weight (lbs) | Storage Case |
|-------------------|-----------------|-----------------------|---------------------|-----------------|-----------------|---------------------|---------------|--------------|
| J6061XCERT | 1/4 | 40-200 | 1 | 25/32 | 3/4 | 11-45/64 | 2.60 | J6006PBF |
| J6063XCERT | 3/8 | 40-200 | 1 | 25/32 | 7/8 | 11-45/64 | 2.60 | J6006PBF |
| J6065XCERT | 3/8 | 200-1000 | 5 | 55/64 | 7/8 | 15-13/64 | 3.00 | J6006PBF |
| | | | | | | 🇺🇸 T033K6-4-2193-1 | ASME B107.300 | |

FIXED HEAD MICROMETER TORQUE WRENCH 200-1000 FT-LBS

- › Includes an extension handle.
- › Torque wrench is 40" long. Weight and over all length are for torque wrench with the extension handle.
- › Packaged in a metal box for easy storage.
- › Calibrated ± 4% of torque reading clockwise and ±6% counter clockwise at 20% to 100% of full scale.
- › Certified wrenches to ±2% one direction are available upon request.



| Product # | Drive Size (in) | Torque Range (ft-lbs) | Increments (ft-lbs) | Head Width (in) | Head Depth (in) | Overall Length (in) | Weight (lbs) | |
|--------------|-----------------|-----------------------|---------------------|-----------------|-----------------|---------------------|--------------|---------------|
| J6023 | 1 | 200-1000 | 5 | 1-7/8 | 2-1/4 | 69 | 24.50 | |
| | | | | 🇺🇸 JIS B4650 | ISO 6789 | T033K6-4-2193-1 | AS28431 | ASME B107.14M |

FIXED HEAD MICROMETER TORQUE WRENCH 400-2000 FT-LBS

- › Includes two extension handles, each 43" long.
- › Torque wrench is 34-1/4" long. Weight and overall length are for torque wrench assembled with both extension handles.
- › Calibrated ±4% of torque reading clockwise and ±6% counter clockwise at 20% to 100% of full scale.

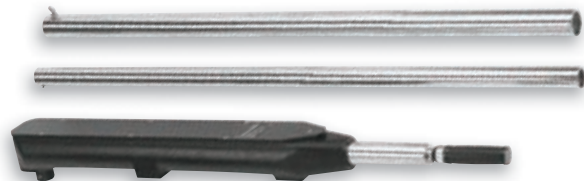

| Product # | Drive Size (in) | Torque Range (ft-lbs) | Increments (ft-lbs) | Head Width (in) | Head Depth (in) | Overall Length (in) | Weight (lbs) | |
|--------------|-----------------|-----------------------|---------------------|-----------------|-----------------|---------------------|--------------|---------------|
| J6025 | 1 | 400-2000 | 10 | 3-1/16 | 4-1/8 | 107-1/2 | 53.10 | |
| | | | | 🇺🇸 JIS B4650 | ISO 6789 | T033K6-4-2193-1 | AS28431 | ASME B107.14M |

RATCHETING HEAD MICROMETER TORQUE WRENCHES - IN-LBS MEETS ASME STANDARD

- ▶ Calibrated to +/- 3% clockwise direction (for J6060A, calibrated to +/- 4% clockwise direction) and +/- 6% counter clockwise direction at 20% to 100% of full scale.
- ▶ Calibration is accomplished by manually loading the torque wrench.
- ▶ Manufactured to meet standard industrial torque applications such as general industry, heavy equipment and maintenance.



| Product # | Drive Size (in) | Torque Range (in-lbs) | Increments (in-lbs) | Head Width (in) | Head Depth (in) | Overall Length (in) | Weight (lbs) | Storage Case | Repair Kit |
|-----------|-----------------|-----------------------|---------------------|-----------------|-----------------|---------------------|--------------|--------------|------------|
| J6060A | 1/4 | 10-50 | 1 | 1-1/16 | 7/8 | 9-1/2 | 1.20 | J6006PBF | J6062RK |
| J6062C | 1/4 | 40-200 | 1 | 1-1/32 | 3/4 | 11-7/8 | 2.60 | J6006PBF | J6062RK |
| J6064C | 3/8 | 40-200 | 1 | 1-1/32 | 7/8 | 11-7/8 | 2.60 | J6006PBF | J6064RK |
| J6066C | 3/8 | 200-1000 | 5 | 1-7/16 | 1-1/64 | 15-1/2 | 3.00 | J6006PBF | J6006RK |
| J6068C | 1/2 | 360-1800 | 10 | 1-7/8 | 1-13/32 | 21-1/2 | 5.00 | J6014PBF | J6014RK |
| J6072C | 1/2 | 600-3000 | 10 | 1-7/8 | 1-13/32 | 27-1/8 | 5.90 | J6014PBF | J6014RK |



ASME B107.14M

RATCHETING HEAD MICROMETER TORQUE WRENCHES - FT-LBS MEETS ASME STANDARD

- ▶ Calibrated to +/- 3% clockwise direction and +/- 6% counter clockwise at 20% to 100% of full scale.
- ▶ Calibration is accomplished by manual loading the torque wrenches.
- ▶ Manufactured to meet standard industrial torque applications, general industry, heavy equipment, and maintenance.

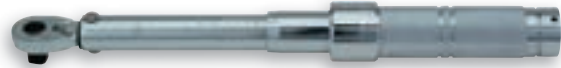

| Product # | Drive Size (in) | Torque Range (ft-lbs) | Increments (ft-lbs) | Head Width (in) | Head Depth (in) | Overall Length (in) | Weight (lbs) | Storage Case | Repair Kit |
|-----------|-----------------|-----------------------|---------------------|-----------------|-----------------|---------------------|--------------|--------------|------------|
| J6006C | 3/8 | 16-80 | 0.5 | 1-7/16 | 1-1/64 | 15-1/2 | 3.00 | J6006PBF | J6006RK |
| J6012C | 3/8 | 20-100 | 0.5 | 1-7/16 | 1-1/64 | 17 | 3.30 | J6006PBF | J6006RK |
| J6008C | 1/2 | 16-80 | 0.5 | 1-7/16 | 1-7/32 | 15-1/2 | 3.00 | J6006PBF | J6008RK |
| J6016C | 1/2 | 30-150 | 1 | 1-7/8 | 1-13/32 | 21-1/2 | 5.00 | J6014PBF | J6014RK |
| J6014C | 1/2 | 50-250 | 1 | 1-7/8 | 1-13/32 | 27-1/8 | 5.90 | J6014PBF | J6014RK |
| J6018AB | 3/4 | 60-300 | 2 | 2-5/8 | 2-1/16 | 32-23/32 | 14.00 | J6007PB | J6018RK |
| J6020AB | 3/4 | 120-600 | 2 | 2-5/8 | 2-1/16 | 41-9/16 | 15.50 | J6007PB | J6018RK |
| J6022B | 1 | 140-700 | 2 | 2-5/8 | 2-5/16 | 46-27/32 | 20.50 | J6007PB | J6022RK |



ASME B107.14M

RATCHETING HEAD MICROMETER TORQUE WRENCHES - NM MEETS ASME STANDARD

- ▶ Calibrated to +/- 3% clockwise direction and +/- 6% counter clockwise direction at 20% to 100% of full scale.
- ▶ Calibration is accomplished by manual loading the torque wrenches.
- ▶ Manufactured to meet standard industrial torque applications, general industry, heavy equipment, and maintenance.

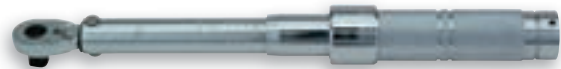

| Product # | Drive Size (in) | Torque Range (Nm) | Increments (Nm) | Head Width (in) | Head Depth (in) | Overall Length (in) | Weight (lbs) | Storage Case | Repair Kit |
|-----------|-----------------|-------------------|-----------------|-----------------|-----------------|---------------------|--------------|--------------|------------|
| J6006MC | 3/8 | 16-80 | 0.5 | 1-7/16 | 1-1/64 | 15-1/2 | 3.00 | J6006PBF | J6006RK |
| J6006NMC | 3/8 | 16-80 | 0.5 | 1-7/16 | 1-1/64 | 15-1/2 | 3.00 | J6006PBF | J6006RK |
| J6016MC | 1/2 | 40-200 | 1 | 1-7/8 | 1-13/32 | 21-1/2 | 5.00 | J6014PBF | J6014RK |
| J6016NMC | 1/2 | 40-200 | 1 | 1-7/8 | 1-13/32 | 21-1/2 | 5.00 | J6014PBF | J6014RK |
| J6014MC | 1/2 | 70-350 | 1 | 1-7/8 | 1-13/32 | 27-1/8 | 5.90 | J6014PBF | J6014RK |
| J6014NMC | 1/2 | 70-350 | 1 | 1-7/8 | 1-13/32 | 27-1/8 | 5.90 | J6014PBF | J6014RK |
| J6020NM | 3/4 | 160-800 | 4 | 2-5/8 | 2-1/16 | 41-9/16 | 15.50 | J6007PB | J6018RK |



ASME B107.14M

RATCHETING HEAD MICROMETER TORQUE WRENCHES - IN-LBS

MEETS T033K6 STANDARD

- › Calibrated to +/- 3% in clockwise direction and +/- 6% in counter clockwise direction.
- › Calibration is accomplished by mechanical loading of each wrench in a horizontal position, and performing a three click test at 20%, 60% and 100% of maximum instrument capacity.
- › Manufactured to meet precision/highly accurate applications such as military and aerospace.



| Product # | Drive Size (in) | Torque Range (in-lbs) | Increments (in-lbs) | Head Width (in) | Head Depth (in) | Overall Length (in) | Weight (lbs) | Storage Case | Repair Kit |
|-----------|-----------------|-----------------------|---------------------|-----------------|-----------------|---------------------|--------------|--------------|------------|
| J6062CX | 1/4 | 40-200 | 1 | 1-1/32 | 3/4 | 11-7/8 | 2.60 | J6006PBF | J6062RK |
| J6064CX | 3/8 | 40-200 | 1 | 1-1/32 | 7/8 | 11-7/8 | 2.60 | J6006PBF | J6064RK |
| J6066CX | 3/8 | 200-1000 | 5 | 1-7/16 | 1-1/64 | 15-1/2 | 3.00 | J6006PBF | J6006RK |
| J6072CX | 1/2 | 600-3000 | 10 | 1-7/8 | 1-13/32 | 27-1/8 | 5.90 | J6014PBF | J6014RK |

USA T033K6-4-2193-1 ASME B107.300

RATCHETING HEAD MICROMETER TORQUE WRENCHES - FT-LBS

MEETS T033K6 STANDARD

- › Calibrated to +/- 3% in clockwise direction and +/- 6% counter clockwise direction.
- › Calibration is accomplished by mechanical loading each wrench in a horizontal position and performing a three click test at 20%, 60% and 100% of maximum instrument capacity.
- › Manufactured to meet precision/highly accurate applications such as military and aerospace.



| Product # | Drive Size (in) | Torque Range (ft-lbs) | Increments (ft-lbs) | Head Width (in) | Head Depth (in) | Overall Length (in) | Weight (lbs) | Storage Case | Repair Kit |
|-----------|-----------------|-----------------------|---------------------|-----------------|-----------------|---------------------|--------------|--------------|------------|
| J6006CX | 3/8 | 16-80 | 0.5 | 1-7/16 | 1-1/64 | 15-1/2 | 3.00 | J6006PBF | J6006RK |
| J6008CX | 1/2 | 16-80 | 0.5 | 1-7/16 | 1-7/32 | 15-1/2 | 3.00 | J6006PBF | J6008RK |
| J6014CX | 1/2 | 50-250 | 1 | 1-7/8 | 1-13/32 | 27-1/8 | 5.90 | J6014PBF | J6014RK |
| J6016CX | 1/2 | 30-150 | 1 | 1-7/8 | 1-13/32 | 21-1/2 | 5.00 | J6014PBF | J6014RK |
| J6018CX | 3/4 | 60-300 | 2 | 2-5/8 | 2-1/16 | 32-23/32 | 14.00 | J6007PB | J6018RK |
| J6020CX | 3/4 | 120-600 | 2 | 2-5/8 | 2-1/16 | 41-9/16 | 15.50 | J6007PB | J6018RK |

USA T033K6-4-2193-1 ASME B107.300

RATCHETING HEAD MICROMETER TORQUE WRENCHES - IN-LBS

MEETS T033K6 STANDARD WITH CERTIFICATION AND N.I.S.T. TRACEABILITY

- › Calibrated to +/- 3% in clockwise direction and +/- 6% in counter clockwise direction.
- › Calibration is accomplished by mechanical loading of each wrench in a horizontal position, and performing a three click test at 20%, 60% and 100% of maximum instrument capacity.
- › Certification documents traceable to N.I.S.T. (National Institute of Standards and Technology).
- › Manufactured to meet precision/highly accurate applications such as military and aerospace.



| Product # | Drive Size (in) | Torque Range (in-lbs) | Increments (in-lbs) | Head Width (in) | Head Depth (in) | Overall Length (in) | Weight (lbs) | Storage Case | Repair Kit |
|------------|-----------------|-----------------------|---------------------|-----------------|-----------------|---------------------|--------------|--------------|------------|
| J6062XCERT | 1/4 | 40-200 | 1 | 1-1/32 | 3/4 | 11-7/8 | 2.60 | J6006PBF | J6062RK |
| J6064XCERT | 3/8 | 40-200 | 1 | 1-1/32 | 7/8 | 11-7/8 | 2.60 | J6006PBF | J6064RK |
| J6066XCERT | 3/8 | 200-1000 | 5 | 1-7/16 | 1-1/64 | 15-1/2 | 3.00 | J6006PBF | J6006RK |
| J6072XCERT | 1/2 | 600-3000 | 10 | 1-7/8 | 1-13/32 | 27-1/8 | 5.90 | J6014PBF | J6014RK |

USA T033K6-4-2193-1 ASME B107.300

RATCHETING HEAD MICROMETER TORQUE WRENCHES - FT-LBS

MEETS TO33K6 STANDARD WITH CERTIFICATION AND N.I.S.T. TRACEABILITY

- › Calibrated to +/- 3% in clockwise direction and +/- 6% in counter clockwise direction.
- › Calibration is accomplished by mechanical loading of each wrench in a horizontal position, and performing a three click test at 20%, 60% and 100% of maximum instrument capacity.
- › Certification documents traceable to N.I.S.T. (National Institute of Standards and Technology).
- › Manufactured to meet precision/highly accurate applications such as military and aerospace.



| Product # | Drive Size (in) | Torque Range (ft-lbs) | Increments (ft-lbs) | Head Width (in) | Head Depth (in) | Overall Length (in) | Weight (lbs) | Storage Case | Repair Kit |
|-------------|-----------------|-----------------------|---------------------|-----------------|-----------------|---------------------|--------------|--------------|------------|
| J6006CXCERT | 3/8 | 16-80 | 0.5 | 1-7/16 | 1-1/64 | 15-1/2 | 3.00 | J6006PBF | J6006RK |
| J6008CXCERT | 1/2 | 16-80 | 0.5 | 1-7/16 | 1-1/64 | 15-1/2 | 3.00 | J6006PBF | J6008RK |
| J6016CXCERT | 1/2 | 30-150 | 1 | 1-7/8 | 1-13/32 | 21-1/2 | 5.00 | J6014PBF | J6014RK |
| J6014CXCERT | 1/2 | 50-250 | 1 | 1-7/8 | 1-13/32 | 27-1/8 | 5.90 | J6014PBF | J6014RK |
| J6018CXCERT | 3/4 | 60-300 | 2 | 2-5/8 | 2-1/16 | 32-23/32 | 14.00 | J6007PB | J6018RK |
| J6020CXCERT | 3/4 | 120-600 | 2 | 2-5/8 | 2-1/16 | 41-9/16 | 15.50 | J6007PB | J6018RK |



TO33K6-4-2193-1

ASME B107.300

RATCHET HEAD REPAIR KITS - TORQUE WRENCH

- › 1/4" to 1" ratchet wheels made from alloy steel for uncompromising strength and durability.
- › Field repair your torque wrench ratchet head easily with the corresponding repair kit.



| Product # | Drive Size (in) | Use With | Weight (lbs) |
|-----------|-----------------|--|--------------|
| J6062RK | 1/4 | J6062C, J6062CX, J6062CXCERT | 0.06 |
| J6064RK | 3/8 | J6064C, J6064CX, J6064CXCERT | 0.07 |
| J6006RK | 3/8 | J6006C, J6006CX, J6006CXCERT, J6006MC, J6006NMC, J6012C, J6066C, J6066CX, J6066CXCERT | 0.18 |
| J6014RK | 1/2 | J6014C, J6014CX, J6014CXCERT, J6014MC, J6014NMC, J6016C, J6016CX, J6016CXCERT, J6016MC, J6016NMC, J6068C, J6072C, J6072CX, J6072CXCERT | 0.37 |
| J6008RK | 1/2 | J6008C, J6008CX, J6008CXCERT | 0.19 |
| J6018RK | 3/4 | J6018AB, J6018CX, J6018CXCERT, J6020AB, J6020CX, J6020CXCERT, J6020NM | 1.36 |
| J6022RK | 1 | J6022B | 1.51 |

TORQUE SCREWDRIVERS - IN-OZ

- › Calibrated to $\pm 4\%$ of torque reading, clockwise at 20% to 100% of full scale.
- › 1/4" Square to 1/4" Hex Adapter included for use with insert bits.
- › Industrial heavy-duty design.
- › Aircraft grade aluminum.
- › Aircraft quality spring.
- › Positive self locking lock ring.
- › Floating three point reaction for repeatability.
- › Laser marked easy-to-read scale.
- › N.I.S.T. (National Institute of Standards and Technology) traceable certification supplied with J6104ACERT.



| Product # | Drive Size (in) | Torque Range (in-oz) | Increments (in-oz) | Width (in) | Height (in) | Overall Length (in) | Weight (lbs) |
|-------------------|-----------------|----------------------|--------------------|------------|-------------|---------------------|--------------|
| J6104A | 1/4 | 20-100 | 2 | 1-1/4 | 1-1/4 | 6-1/2 | 1.00 |
| J6104ACERT | 1/4 | 20-100 | 2 | 1-1/4 | 1-1/4 | 6-1/2 | 1.00 |

ASME B107.14M

TORQUE SCREWDRIVERS - IN-LBS

- › Calibrated to $\pm 4\%$ of torque reading, clockwise at 20% to 100% of full scale.
- › 1/4" Square to 1/4" Hex Adapter included for use with insert bits.
- › Industrial heavy-duty design.
- › Aircraft grade aluminum.
- › Aircraft quality spring.
- › Positive self locking lock ring.
- › Floating three point reaction for repeatability.
- › Laser marked easy-to-read scale.
- › N.I.S.T. (National Institute of Standards and Technology) traceable certification supplied with J6106ACERT.



| Product # | Drive Size (in) | Torque Range (in-lbs) | Increments (in-lbs) | Width (in) | Height (in) | Overall Length (in) | Weight (lbs) |
|-------------------|-----------------|-----------------------|---------------------|------------|-------------|---------------------|--------------|
| J6106A | 1/4 | 7-36 | 1 | 1-1/4 | 1-1/4 | 6-1/2 | 1.00 |
| J6106ACERT | 1/4 | 7-36 | 1 | 1-1/4 | 1-1/4 | 6-1/2 | 1.00 |

ASME B107.14M

DIAL TORQUE WRENCHES - IN-LBS/CM-KG

- › 6-30 in-lbs. thru 120-600 in-lbs. / 7-35 cm-kg thru 140-700 cm-kg.
- › Accurate to $\pm 4\%$ of torque reading in both directions at 20% to 100% of full scale.
- › Industrial all steel or aluminum torque transfer components.
- › High alloy torsion drive design — accuracy not effected by hand position.
- › Dual scale (English/Metric) with clockwise and counterclockwise operation — fewer wrenches needed to complete job.
- › Memory needles are standard on all wrenches except electric light models.
- › Easy-to-read, high contrast scale.
- › Laser marked serial number for traceability.
- › N.I.S.T. (National Institute of Standards and Technology) traceable CW certification supplied with each wrench.



| Product # | Drive Size (in) | Torque Range (metric) | Torque Range (in-lbs) | Increments (in-lbs) | Overall Length (in) | Weight (lbs) |
|---------------|-----------------|-----------------------|-----------------------|---------------------|---------------------|--------------|
| J6168F | 1/4 | 7-35 cm-kg | 6-30 | 0.5 | 10 | 1.00 |
| J6169F | 1/4 | 18-90 cm-kg | 15-75 | 1 | 10 | 1.40 |
| J6177F | 3/8 | 56-280 cm-kg | 50-250 | 5 | 10 | 1.30 |
| J6181F | 3/8 | 140-700 cm-kg | 120-600 | 10 | 10 | 2.20 |

JIS B4650 ISO 6789 ASME B107.14M

DIAL TORQUE WRENCHES - FT-LBS/MKG

- › Accurate to ± 4% of torque reading in both directions at 20% to 100% of full scale.
- › Industrial all steel or aluminum torque transfer components.
- › High alloy torsion drive design — accuracy not effected by hand position.
- › Dual scale (English/Metric) with clockwise and counterclockwise operation — fewer wrenches needed to complete job.
- › Memory needles are standard on all wrenches except electric light models.
- › Easy-to-read, high contrast scale.
- › Laser marked serial number for traceability.
- › N.I.S.T. (National Institute of Standards and Technology) traceable CW certification supplied with each wrench.
- › J6133F and J6141F include one removeable extension handle for easy force application.
- › J6149F includes five removeable extensions (requires two operators) and electric LED and buzzer.



| Product # | Drive Size (in) | Torque Range (ft-lbs) | Torque Range (metric) | Increments (ft-lbs) | Overall Length (in) | Weight (lbs) |
|---------------|-----------------|-----------------------|-----------------------|---------------------|---------------------|--------------|
| J6113F | 3/8 | 10-50 | 1.4-7 mkg | 1 | 10-1/4 | 2.20 |
| J6121F | 1/2 | 35-175 | 5-24 mkg | 5 | 21-1/2 | 4.00 |
| J6125F | 1/2 | 50-250 | 7-35 mkg | 5 | 21-1/2 | 3.80 |
| J6134F | 3/4 | 70-350 | — | 10 | 27-7/8 | 7.10 |
| J6133F | 3/4 | 120-600 | 16-80 mkg | 10 | 46-1/2 | 9.90 |
| J6141F | 1 | 200-1000 | 28-140 mkg | 20 | 74-1/4 | 27.00 |
| J6149F | 1 | 400-2000 | 56-280 mkg | 40 | 110-3/4 | 48.00 |

DIAL TORQUE WRENCHES - NM/IN-LBS, FT-LBS

- › 2-10 Nm thru 50-250 Nm / 18-90 in-lbs. thru 35-175 ft-lbs
- › Accurate to ± 4% of torque reading in both directions at 20% to 100% of full scale.
- › Industrial all steel or aluminum torque transfer components.
- › High alloy torsion drive design — accuracy not effected by hand position.
- › Dual scale (Metric/English) with clockwise and counterclockwise operation — fewer wrenches needed to complete job.
- › Memory needles are standard on all wrenches except electric light models.
- › Easy-to-read, high contrast scale.
- › Laser marked serial number for traceability.
- › N.I.S.T. (National Institute of Standards and Technology) traceable CW certification supplied with each wrench.



| Product # | Drive Size (in) | Torque Range (ft-lbs) | Torque Range (in-lbs) | Torque Range (Nm) | Increments (Nm) | Overall Length (in) | Weight (lbs) |
|-----------------|-----------------|-----------------------|-----------------------|-------------------|-----------------|---------------------|--------------|
| J6169NMF | 1/4 | — | 18-90 | 2-10 | 0.2 | 10 | 1.30 |
| J6177NMF | 3/8 | — | 50-250 | 6-30 | 0.5 | 10 | 1.50 |
| J6113NMF | 3/8 | 10-50 | — | 14-70 | 2 | 14-7/8 | 2.10 |
| J6121NMF | 1/2 | 35-175 | — | 50-250 | 5 | 21-1/2 | 4.00 |

DIAL ELECTRONIC TORQUE WRENCHES - IN-LBS, FT-LBS

- › Extended operation range in ft-lbs., in-lbs. and Nm units.
- › Precision Accuracy: + / - 1% in BOTH directions.
- › Accuracy valid from 10% to 100% of full scale.
- › Large easy to read digits.
- › Patented rotary bezel. LCD and key pad rotate both ways, up to 359 degrees for easy viewing.
- › Torque target zone adjustable 1% to 10% indicates when the desired torque limit is approaching.
 - › Yellow light indicates the low end of the zone
 - › Green light and buzzer sounds when the target is reached
 - › Red Light with intermittent buzzer indicates over-torqued
- › One button target torque setting.
- › Ergonomically designed for user comfort.
- › Operates on standard 9 volt battery.
- › Torsion drive strain gauge technology improves accuracy.
- › Users can pull on the handle anywhere and still maintain accuracy.
- › Built on durable chrome body (not painted) with nylon-6 rotary bezel.
- › Rotary dial is shrouded with metal walls to protect display.
- › Peak, hold and track modes standard.
- › Fast sampling rate helps maintain high accuracy during torque applications.
- › Easy to use by production line or quality control inspector.



J6345



J6345B

| Product # | Drive Size (in) | Torque Range (ft-lbs) | Torque Range (in-lbs) | Torque Range (Nm) | Increments (ft-lbs) | Increments (in-lbs) | Increments (Nm) | Width (in) | Height (in) | Overall Length (in) | Weight (lbs) |
|---------------|-----------------|-----------------------|-----------------------|-------------------|---------------------|---------------------|-----------------|------------|-------------|---------------------|--------------|
| J6339 | 1/4 | 0.63-6.25 | 7.5-75 | 0.84-8.47 | 0.01 | 0.01 | 0.01 | 3 | 2-1/2 | 11 | 1.40 |
| J6342 | 1/4 | 0.83-8.33 | 10-100 | 1.11-11.13 | 0.01 | 0.1 | 0.01 | 3 | 2-1/2 | 11 | 1.40 |
| J6345 | 3/8 | 2.1-21 | 25-250 | 2.8-28.2 | 0.01 | 0.1 | 0.01 | 3 | 2-1/2 | 11 | 1.40 |
| J6345A | 3/8 | 5-50 | 60-600 | 6.78-67.8 | 0.01 | 0.1 | 0.1 | 3 | 2-1/2 | 11 | 1.40 |
| J6345B | 1/2 | 10-100 | 120-1200 | 13.3-133.5 | 0.01 | 1 | 1 | 3 | 4 | 22 | 2.80 |
| J6346 | 1/2 | 25-250 | 300-3000 | 33.8-338 | 0.1 | 1 | 0.1 | 3 | 4 | 22 | 2.80 |
| J6347 | 3/4 | 60-600 | 720-7200 | 81-813 | 0.1 | 1 | 0.1 | 3 | 4 | 22 | 2.80 |
| J6349 | 1 | 100-1000 | - | 140-1400 | - | - | - | 4 | 5 | 77 | 20.00 |
| J6351 | 1 | 200-2000 | - | 271-2700 | - | - | - | 4 | 5 | 125 | 46.00 |

ASME B107.300



J6351

ELECTRONIC FIXED RATCHETING HEAD TORQUE WRENCHES

- › Accuracy of +/- 2% of indicated value in both clockwise and counter clockwise directions.
- › Broad accuracy range extends from 10% of Full Scale to 100% of Full Scale to help reduce the number of torque wrenches required.
- › Ninety-nine "on-board" memory storage locations help improve efficiency when taking multiple torque readings.
- › Three units of measure are available (Ft-lb, In-lb, and Nm).
- › Three operating modes: Track Mode, Peak Hold and Auto Clear.
- › Fast sampling rate helps maintain high accuracy during torque applications.
- › Torque wrench head rotates to allow for easy viewing of LCD display.
- › Easy to read LCD Display with large digits.
- › 3-way Red/Green/Yellow lights.
- › Yellow light appears at the low end of the zone.
- › Green light appears and buzzer sounds when the target is reached.
- › Red light appears with intermittent buzzer when it is over torqued.
- › An audible buzzer helps identify when desired torque target zones are approaching and met.
- › Target torque zone is adjustable from 1% to 10% of targeted torque value.
- › Fixed ratcheting head features a robust 24-tooth design with 15° arc swing, alloy steel drive gear for strength and durability, low profile for easy access and a reversing lever design for quick, one-hand operation.
- › Ergonomically designed, comfortable cushion grip.



| Product # | Size (in) | Drive Size (in) | Torque Range (ft-lbs) | Torque Range (in-lbs) | Torque Range (Nm) | Increments (ft-lbs) | Increments (in-lbs) | Increments (Nm) | Width (in) | Height (in) | Overall Length (in) | Weight (lbs) | Battery Type |
|------------------|-----------|-----------------|-----------------------|-----------------------|-------------------|---------------------|---------------------|-----------------|------------|-------------|---------------------|--------------|---------------|
| JH4-250R | 17/40 | 1/4 | 2.1-20.8 | 25-250 | 2.8-28.2 | 0.01 | 0.1 | 0.01 | 1-3/4 | 2 | 20-1/2 | 2.50 | 4 AA included |
| JH5-100FR | 14/25 | 3/8 | 10-100 | 20-1200 | 13.6-135.6 | 0.1 | 1 | 0.1 | 1-3/4 | 2 | 20-1/2 | 2.70 | 4 AA included |
| JH7-250FR | 61/83 | 1/2 | 25-250 | 300-3000 | 33.9-338.9 | 0.1 | 1 | 0.1 | 1-3/4 | 2 | 27-3/4 | 3.30 | 4 AA included |

ASME B107.300

ELECTRONIC TORQUE WRENCH SOFTWARE AND USB INTERFACE

- › Proto® Software allows for full two-way communication between the torque wrench and a laptop or desktop computer.
- › Add-on the software and plug in the cable for full computer interface.
- › All data captured by the torque wrench can be downloaded directly into a spreadsheet: either all at once from on-board memory or one reading at a time.
- › Control all settings on the torque wrench from the wrench or computer.
- › Software includes CD and connection cable which interfaces with computer's RS-232 connection.



| Product # | Width (in) | Height (in) | Overall Length (in) | Weight (lbs) |
|----------------|------------|-------------|---------------------|--------------|
| JH600SW | 5 | 1-3/4 | 5 | 0.60 |

Use With: JH4-250, JH4-250R, JH5-100F, JH5-100FR, JH7-250F, JH7-250FR, J6470-C, J6472-C, J6474-C, J6476-C, J6478-C

DIGITAL ANGLE ADAPTER

- › Digital angle value readout.
- › Ultra simple use: autotest and reset upon powering on.
- › Adapter magnetized so it attaches to all types of ratchets.
- › +/-2° accuracy (rotating 90° at speed of 30° / sec).
- › +/-2% clockwise and counter clockwise for torque accuracy.
- › LEDs for easy viewing of results and audible beep when desired level is reached.
- › Buzzer and LED indicator for the 9 pre-settable target torques.
- › 50 data memory for recall and joint torque auditing.
- › Auto Sleep after about 2 minutes idle.
- › Both AAA and rechargeable batteries are compatible.



| Product # | Overall Length (in) | Weight (lbs) | Battery Type | Storage Case |
|-----------------|---------------------|--------------|----------------|--------------|
| J6300TWA | 2-9/32 | 0.50 | 2 AAA included | J6300PB |

ASME B107.300

DIGITAL TORQUE AND ANGLE ADAPTERS

- › Torque and angle tightening with one tool: productivity improvement, digital display minimizes reading errors, and delivers high precision.
- › +/-2° (rotating 90° at speed of 30° / sec) for angle accuracy.
- › +/-3% clockwise or +/-4% counter clockwise for torque accuracy.
- › LEDs for easy viewing of results and audible beep when desired level is reached.
- › Buzzer and LED indicator for the 9 pre-settable target torques or angles.
- › Five Units Selectable (N.m, ft-lb, in.lb, kg.cm, degree).
- › 50 data memory for recall and joint torque-angle auditing.
- › Auto Sleep after about 2 minutes idle.
- › Both AAA and rechargeable batteries are compatible.



| Product # | Drive Size (in) | Torque Range (ft-lbs) | Torque Range (in-lbs) | Torque Range (Nm) | Overall Length (in) | Weight (lbs) | Battery Type | Storage Case |
|------------|-----------------|-----------------------|-----------------------|-------------------|---------------------|--------------|----------------|--------------|
| J6280TA100 | 3/8 | 5-99.5 | 60-1195 | 6.8-135 | 3-23/64 | 0.70 | 2 AAA included | J6310PB |
| J6280TA150 | 1/2 | 7.4-147.5 | 88-1770 | 10-200 | 3-23/64 | 0.70 | 2 AAA included | J6415PB |
| J6280TA250 | 1/2 | 12.5-250.7 | 150-3009 | 17-340 | 3-23/64 | 0.70 | 2 AAA included | J6425PB |

ASME B107.300

3/8" DRIVE 9 PIECE TORQUE ADAPTER SET - 12 POINT

- › Designed for easy torque calibrations.
- › Adapters measure 2" from the center of the square drive to the center of the adapter opening.
- › Special heat-treated alloy steel helps to increase strength and durability.
- › Box end wall thickness is specially engineered to provide strength while still allowing ample room for access to reach difficult fasteners.
- › 12 point box end allows for fine indexing, helping to improve speed and access. Fits 4, 6 and 12 point fasteners.



| Product # | Drive Size (in) | Weight (lbs) |
|-----------|-----------------|--------------|
| J5100 | 3/8 | 1.32 |



AS954E S3.8.1

3/8" DRIVE TORQUE ADAPTERS - 12 POINT

- › Designed for easy torque calibrations.
- › Adapters measure 2" from the center of the square drive to the center of the adapter opening.
- › Special heat-treated alloy steel helps to increase strength and durability.
- › Box end wall thickness is specially engineered to provide strength while still allowing ample room for access to reach difficult fasteners.
- › 12 point box end allows for fine indexing, helping to improve speed and access. Fits 4, 6 and 12 point fasteners.

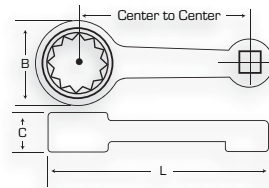

| Product # | Size (in) | Drive Size (in) | Head Width (in) (B) | Head Depth (in) (C) | Overall Length (in) (L) | Weight (lbs) |
|-----------|-----------|-----------------|---------------------|---------------------|-------------------------|--------------|
| J5112 | 3/8 | 3/8 | 9/16 | 17/64 | 2-11/16 | 0.08 |
| J5114 | 7/16 | 3/8 | 21/32 | 19/64 | 2-47/64 | 0.10 |
| J5116 | 1/2 | 3/8 | 47/64 | 21/64 | 2-25/32 | 0.10 |
| J5118 | 9/16 | 3/8 | 13/16 | 23/64 | 2-13/16 | 0.12 |
| J5120 | 5/8 | 3/8 | 29/32 | 25/64 | 2-55/64 | 0.12 |
| J5122 | 11/16 | 3/8 | 1 | 27/64 | 2-29/32 | 0.12 |
| J5124 | 3/4 | 3/8 | 1-5/64 | 29/64 | 2-61/64 | 0.12 |
| J5126 | 13/16 | 3/8 | 1-11/64 | 31/64 | 2-63/64 | 0.14 |
| J5128 | 7/8 | 3/8 | 1-17/64 | 33/64 | 3-1/32 | 0.16 |



AS954E S3.8.1



ELECTRONIC TORQUE TESTERS

- › Use to test all types of torque wrenches in all types of settings where full scale calibration is needed or where a quick Pass/Fail check is required.
- › Accuracy of +/- 1% of indicated value in both clockwise and counter clockwise directions.
- › Broad accuracy range extends from 10% to 100% of full scale.
- › Three units of measure are available ft-lb, in-lb, and Nm.
- › Three operating modes: Track Mode, Peak Hold and First Peak (for use with Click-style Torque wrenches).
- › Fast sampling rate helps maintain high accuracy during torque applications.
- › Each tester is built with a male square drive and also comes supplied with a female-to-female square drive adapter.
- › Powered by a standard 9V battery, providing up to 50 hours run time.
- › N.I.S.T. (National Institute of Standards and Technology) traceable certification supplied with each tester.
- › Optional all-steel stand (J6470S) provides a strong support with minimal footprint.



ELECTRONIC USB TORQUE TESTERS

- › Powers the tester via USB cable.
- › Recharges Internal Nimh battery.
- › Allows communication with computer for downloading torque readings via communication port on computer. Use with JH6000SW.
- › An extensive two-way communication command set (ASCII text commands) that can control the tester remotely, from a computer, using any third party communication program (including Hyperterminal).
 - › Set target torque remotely.
 - › Set units remotely.
 - › Set target tolerance remotely.
 - › Set mode (track, peak, first peak) remotely.
 - › Query torque value remotely.
 - › Clear the Display remotely.
 - › Get (call) torque value remotely by sending a Carriage Return to tester.
- › 100 torque reading memory (torque value saved to memory when save key is pressed on keypad).

| Product # | USB Version # | Drive Size (in) | Torque Range (ft-lbs) | Torque Range (in-lbs) | Torque Range (Nm) | Increments (ft-lbs) | Increments (in-lbs) | Increments (Nm) | Width (in) | Height (in) | Overall | | | Battery Type |
|-----------|---------------|-----------------|-----------------------|-----------------------|-------------------|---------------------|---------------------|-----------------|------------|-------------|-------------|--------------|-----------------|--------------|
| | | | | | | | | | | | Length (in) | Weight (lbs) | | |
| J6470 | J6470-C | 1/4 | 0.42-4.17 | 5-50 | 0.56-5.65 | 0.01 | 0.01 | 0.01 | 6 | 4-1/2 | 6 | 6.00 | 9 volt included | |
| J6472 | J6472-C | 3/8 | 2.1-20.8 | 25-250 | 2.8-28.2 | 0.01 | 0.1 | 0.01 | 6 | 4-1/2 | 6 | 6.00 | 9 volt included | |
| J6474 | J6474-C | 3/8 | 5-50 | 60-600 | 6.78-67.8 | 0.01 | 0.1 | 0.1 | 6 | 4-1/2 | 6 | 6.00 | 9 volt included | |
| J6476 | J6476-C | 1/2 | 25-250 | 300-3000 | 33.8-338 | 0.1 | 1 | 0.1 | 6 | 4-1/2 | 6 | 6.00 | 9 volt included | |
| J6478 | J6478-C | 3/4 | 60-600 | 720-7200 | 81.3-813 | 0.1 | 1 | 0.1 | 6 | 4-1/2 | 6 | 6.00 | 9 volt included | |



ASME B107.300

TORQUE TESTER FLOOR STAND

- › Floor stand for Proto® Torque Testing systems makes installation quick and easy.
- › All steel construction.
- › Mounting holes predrilled to match Proto® test systems.
- › Floor mount holes are pre-drilled for securing to the floor.
- › Small footprint for space saving economy.
- › Durable powder coated paint.

| Product # | Width (in) | Height (in) | Overall Length (in) | Weight (lbs) |
|---------------|------------|-------------|---------------------|--------------|
| J6470S | 7 | 32 | 4 | 20.00 |

Use With: J6470, J6472, J6474, J6476, J6478



ELECTRONIC TORQUE METER

- › The Proto® Electronic Torque Meter is a true all-in-one torque meter.
- › The Proto® Electronic Torque Meter provides the maximum flexibility in lab and production applications. This system meets a broad range of needs from demanding users.
- › It can help eliminate the need for multiple electronic torque wrenches and testers. The system grows as the demands of the user grow.
- › Ideal for use in production (application of torque), quality control (verification of torque) and for the calibration and or verification of torque wrench accuracy (calibration labs and kit rooms).
- › Easy to learn and use. Anyone can be up and running in seconds. Unit designed with the end user in mind.

| Product # | Width (in) | Height (in) | Overall Length (in) | Weight (lbs) | Battery Type |
|--------------|------------|-------------|---------------------|--------------|-----------------|
| J6360 | 3-1/4 | 2 | 7-1/4 | 2.34 | 9 volt included |

ASME B107.300



1.0% IN-LINE EXTENSION TRANSDUCERS

- › In-line extension transducers, connect between a wrench and a socket to measure the torque that is applied to a fastener.
- › This versatile type of transducer converts a hand held torque meter (J6360) into a highly accurate digital torque wrench.
- › In-line transducers can also be used as torque wrench testers when mounted to a fixture.



| Product # | Drive Size (in) | Torque Range (ft-lbs) | Torque Range (in-lbs) | Width (in) | Height (in) | Overall Length (in) | Use With | Weight (lbs) |
|--------------|-----------------|-----------------------|-----------------------|------------|-------------|---------------------|----------|--------------|
| J6361 | 3/8 | – | 25-250 | 1-1/4 | 3-1/4 | 1-1/4 | J6360 | 0.52 |
| J6362 | 3/8 | 5-50 | – | 1-1/4 | 3-1/4 | 1-1/4 | J6360 | 0.55 |
| J6363 | 1/2 | 15-150 | – | 1-7/16 | 3-5/8 | 1-7/16 | J6360 | 0.79 |
| J6364 | 1/2 | 25-250 | – | 1-7/16 | 3-5/8 | 1-7/16 | J6360 | 0.89 |

ASME B107.300

0.5% BENCH MOUNT TRANSDUCERS

- › “Plug and play” torque transducers. Automatic set-up of transducers means user friendly operation and less down time.
- › Versatile all-in-one unit can be used as both an accurate torque wrench and as an accurate torque tool tester. No need to own separate torque testers and electronic torque wrenches.
- › First peak of torque mode allows hand calibration of click type torque wrenches.
- › Memory for traceability.



| Product # | Drive Size (in) | Torque Range (ft-lbs) | Torque Range (in-lbs) | Width (in) | Height (in) | Overall Length (in) | Use With | Weight (lbs) |
|-----------|-----------------|-----------------------|-----------------------|------------|-------------|---------------------|----------|--------------|
| J6365 | 1/4 | – | 10-100 | 2-3/4 | 2-1/4 | 2-3/4 | J6360 | 0.90 |
| J6366 | 3/8 | – | 25-250 | 2-3/4 | 2-3/4 | 2-3/4 | J6360 | 0.83 |
| J6367 | 3/8 | 5-50 | – | 2-3/4 | 2-3/4 | 2-3/4 | J6360 | 1.13 |
| J6368 | 1/2 | 25-250 | – | 4 | 3-3/4 | 4 | J6360 | 3.14 |
| J6369 | 3/4 | 50-500 | – | 4 | 4-5/8 | 4 | J6360 | 3.16 |
| J6371 | 1/4 | – | 5-50 | 2-3/4 | 2-1/4 | 2-3/4 | J6360 | 0.60 |
| J6372 | 1/2 | 15-150 | – | 4 | 3-3/4 | 4 | J6360 | 0.60 |
| J6373 | 3/4 | 60-600 | – | 4 | 4-5/8 | 4 | J6360 | 0.90 |
| J6374 | 1 | 100-1000 | – | 6 | 5 | 8-1/2 | J6360 | 0.90 |
| J6375 | 1 | 200-2000 | – | 6 | 5 | 8-1/2 | J6360 | 0.90 |



ASME B107.300

BRACKET FOR BENCH MOUNT TRANSDUCERS

- › Heavy-duty mounting bracket for bench mount transducers.
- › Use up to 600 ft-lbs.

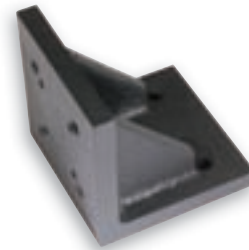

| Product # | Width (in) | Height (in) | Overall Length (in) | Weight (lbs) |
|-----------|------------|-------------|---------------------|--------------|
| J6370 | 5 | 5 | 5 | 5.75 |



Use With: J6365, J6366, J6367, J6368, ASME B107.300
J6369, J6371, J6372, J6373, J6374, J6375

TORQUE MULTIPLIER DISPLAY WRENCHES

- › When placed between the torque multiplier and the fastener, the Proto® Torque Multiplier Display Wrench will display the actual torque applied to the fastener.
- › Precision Accuracy: + / - 1% in BOTH directions.



| Product # | Drive Size (in) | Torque Range (ft-lbs) | Torque Range (Nm) | Increments (ft-lbs) | Increments (Nm) | Width (in) | Height (in) | Overall Length (in) | Weight (lbs) |
|-----------|-----------------|-----------------------|-------------------|---------------------|-----------------|------------|-------------|---------------------|--------------|
| J6349A | 1 | 100-1000 | 133-1335 | 1 | 1 | 4 | 5 | 44 | 15.00 |
| J6352 | 1 | 200-2000 | 267-2670 | 1 | 1 | 4 | 5 | 24 | 15.00 |

TORQUE MULTIPLIERS 750 FT-LBS

- › Maximum rated input: 227 ft-lbs. (308 Nm).
- › Maximum rated output: 750 ft-lbs. (1017 Nm).
- › Standard torque accuracy is +/- 5% of reading.
- › Reaction system: tubular reaction bar.
- › Gear system: single stage planetary.



| Product # | Input Drive (in) | Output Drive (in) | Torque Ratio | Head Depth (in) (A) | Head Length (in) (B) | Handle Length (in) (L1) | Overall Length (in) (L) | Weight (lbs) |
|-------------------|------------------|-------------------|--------------|---------------------|----------------------|-------------------------|-------------------------|--------------|
| J6202A | 1/2 | 3/4 Sq. Male | 1:3.33 | 3-3/32 | 2-13/16 | 5-1/4 | 8-19/32 | 4.00 |
| J6202ACERT | 1/2 | 3/4 Sq. Male | 1:3.33 | 3-3/32 | 2-13/16 | 5-1/4 | 8-19/32 | 4.00 |

TORQUE MULTIPLIERS 1200 FT-LBS

- › Maximum rated input: 200 ft-lbs. (271 Nm).
- › Maximum rated output: 1200 ft-lbs. (1626 Nm).
- › Standard torque accuracy is +/- 5% of reading.
- › Reaction system: tubular reaction bar.
- › Gear system: single stage planetary.
- › Angle of turn protractor: 5° increments.



| Product # | Input Drive (in) | Output Drive (in) | Torque Ratio | Head Depth (in) (A) | Head Length (in) (B) | Handle Length (in) (L1) | Overall Length (in) (L) | Weight (lbs) | Repair Kit |
|------------------|------------------|-------------------|--------------|---------------------|----------------------|-------------------------|-------------------------|--------------|------------|
| J6212 | 1/2 | 3/4 Sq. Male | 1:6 | 4 | 3-15/16 | 14-1/8 | 19-19/32 | 9.10 | J6212RD |
| J6212CERT | 1/2 | 3/4 Sq. Male | 1:6 | 4 | 3-15/16 | 14-1/8 | 19-19/32 | 9.10 | J6212RD |

TORQUE MULTIPLIERS 2200 FT-LBS

- › Maximum rated input: 162 ft-lbs. (220 Nm).
- › Maximum rated output: 2200 ft-lbs. (2983 Nm).
- › Standard torque accuracy is +/- 5% of reading.
- › Reaction system: tubular reaction bar.
- › Gear system: two stage planetary.
- › Angle of turn protractor: 5° increments.
- › Anti-backlash device: self-contained, 3 position.



| Product # | Input Drive (in) | Output Drive (in) | Torque Ratio | Head Depth (in) (A) | Head Length (in) (B) | Handle Length (in) (L1) | Overall Length (in) (L) | Weight (lbs) | Repair Kit |
|------------------|------------------|-------------------|--------------|---------------------|----------------------|-------------------------|-------------------------|--------------|------------|
| J6222 | 1/2 | 1 Sq. Male | 1:13.6 | 5-3/4 | 4-1/16 | 14-1/8 | 19-19/32 | 15.20 | J6222RD |
| J6222CERT | 1/2 | 1 Sq. Male | 1:13.6 | 5-3/4 | 4-1/16 | 14-1/8 | 19-19/32 | 15.20 | J6222RD |

TORQUE MULTIPLIERS 3200 FT-LBS

- › Maximum rated input: 173 ft-lbs. (235 Nm).
- › Maximum rated output: 3200 ft-lbs. (4338 Nm).
- › Standard torque accuracy is +/- 5% of reading.
- › Reaction system: tubular reaction bar.
- › Gear system: two stage planetary.
- › Angle of turn protractor: 5° increments.
- › Anti-backlash device: self-contained, 3 position.



| Product # | Input Drive (in) | Output Drive (in) | Torque Ratio | Head Depth (in) (A) | Head Length (in) (B) | Handle Length (in) (L1) | Overall Length (in) (L) | Weight (lbs) | Repair Kit |
|------------------|------------------|-------------------|--------------|---------------------|----------------------|-------------------------|-------------------------|--------------|------------|
| J6232 | 1/2 | 1 Sq. Male | 1:18.5 | 6-1/2 | 4-1/16 | 14-1/8 | 19-19/32 | 18.30 | J6232RD |
| J6232CERT | 1/2 | 1 Sq. Male | 1:18.5 | 6-1/2 | 4-1/16 | 14-1/8 | 19-19/32 | 18.30 | J6232RD |

TORQUE MULTIPLIER - REACTION PLATE SYSTEM - 2200 FT-LBS

- › Maximum rated input: 162 ft-lbs. (220 Nm).
- › Maximum rated output: 2200 ft-lbs. (2983 Nm).
- › Standard torque accuracy is +/- 5% of reading.
- › Reaction system: reaction plate with slave drive
- › Gear system: two stage planetary.
- › Anti-backlash device: self-contained, 3 position.
- › Can be used for Mack truck leaf springs.



| Product # | Input Drive (in) | Output Drive (in) | Torque Ratio | Head Depth (in) (A) | Head Length (in) (B) | Overall Length (in) (L) | Weight (lbs) | Repair Kit |
|--------------|------------------|-------------------|--------------|---------------------|----------------------|-------------------------|--------------|------------|
| J6234 | 1/2 | 1 Sq. Male | 1:13.6 | 5-1/2 | 4-7/8 | 14 | 17.20 | J6222RD |

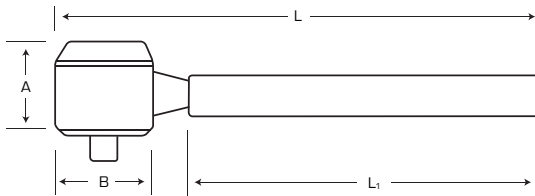

TORQUE MULTIPLIER - REACTION PLATE SYSTEM - 5000 FT-LBS

- › Maximum rated input: 189 ft-lbs. (256 Nm).
- › Maximum rated output: 5000 ft-lbs. (6778 Nm).
- › Standard torque accuracy is +/- 5% of reading.
- › Reaction system: reaction plate with slave drive.
- › Gear system: three stage planetary.
- › Anti-backlash device: self-contained, 3 position.



| Product # | Input Drive (in) | Output Drive (in) | Torque Ratio | Head Depth (in) (A) | Head Length (in) (B) | Overall Length (in) (L) | Weight (lbs) | Repair Kit |
|--------------|------------------|-------------------|--------------|---------------------|----------------------|-------------------------|--------------|------------|
| J6242 | 1/2 | 1-1/2 Sq. Male | 1:26.5 | 8-3/4 | 5-5/8 | 14-29/32 | 34.00 | J6242RD |



TORQUE MULTIPLIER - REACTION PLATE SYSTEM - 8000 FT-LBS

- › Maximum rated input: 154 ft-lbs. (209 Nm).
- › Maximum rated output: 8000 ft-lbs. (10846 Nm).
- › Standard torque accuracy is +/- 5% of reading.
- › Reaction system: reaction plate with slave drive.
- › Gear system: three stage planetary.
- › Anti-backlash device: self-contained, 3 position.



| Product # | Input Drive (in) | Output Drive (in) | Torque Ratio | Head Depth (in) (A) | Head Length (in) (B) | Overall Length (in) (L) | Weight (lbs) | Repair Kit |
|--------------|------------------|-------------------|--------------|---------------------|----------------------|-------------------------|--------------|------------|
| J6252 | 1/2 | 1-1/2 Sq. Male | 1:52 | 10-3/4 | 5-13/16 | 15-3/16 | 50.30 | J6252RD |

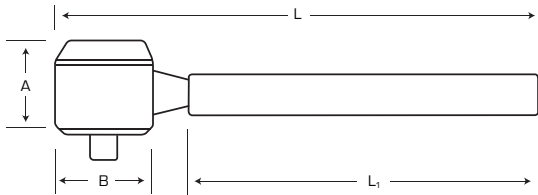

TORQUE MULTIPLIER SQUARE DRIVE REPLACEMENT KITS

- ▶ Proto® Torque Multipliers provide overload protection with replaceable output square drives that are designed to twist off at 3%-10% over maximum output capacity.

| Product # | Drive Size (in) | Use With | Weight (lbs) |
|----------------|-----------------|-------------------------|--------------|
| J6212RD | 3/4 | J6212, J6212CERT | 0.20 |
| J6222RD | 1 | J6222, J6222CERT, J6234 | 0.53 |
| J6232RD | 1 | J6232, J6232CERT | 0.56 |
| J6242RD | 1-1/2 | J6242 | 1.55 |
| J6252RD | 1-1/2 | J6252 | 1.72 |



ACCESSORY AIR DRIVE 200 FT-LBS

- ▶ Powered input to a torque multiplier can reduce operator fatigue, increase productivity.
- ▶ Designed to drive Proto® Torque Multipliers (except J6202A).
- ▶ Maximum torque output: 200 ft-lbs. (271 Nm).
- ▶ Maximum running air pressure: 60 PSI.
- ▶ Output free speed: 70 RPM.
- ▶ Output rotation: clockwise and counterclockwise.

| Product # | Drive Size (in) | Output Drive (in) | Maximum Diameter (in) | Overall Length (in) | Weight (lbs) |
|--------------|-----------------|-------------------|-----------------------|---------------------|--------------|
| J6201 | 1/4 | 1/2 Sq. Male | 3-1/8 | 16-1/4 | 11.00 |



AIR DRIVE CONVERTER 200 FT-LBS

- ▶ Powered input to a torque multiplier can reduce operator fatigue, increase productivity.
- ▶ Designed to drive Proto® Torque Multipliers (except J6202A) when used with an air or electric drive tool.
- ▶ Not designed for use with Impact Tools.
- ▶ Maximum torque output: 200 ft-lbs. (271 Nm).
- ▶ Maximum torque input: 38 ft-lbs. (52 Nm).

| Product # | Drive Size (in) | Input Drive (in) | Output Drive (in) | Torque Ratio | Diameter (in) | Overall Length (in) | Weight (lbs) |
|--------------|-----------------|------------------|-------------------|--------------|---------------|---------------------|--------------|
| J6203 | 1/2 | 1/2 | 1/2 Sq. Male | 1:5.2 | 3-1/8 | 4 | 5.50 |





PROTO



**WE'RE OUT TO MAKE WORK, LESS WORK. ONE TURN
OF THE WRENCH AT A TIME.**

That begins with a comprehensive product line that puts the right wrench for the task in your hand.

Ours includes standard, extra long, flex-head, angle-head, box, deep offset box, ratcheting box,

obstruction, adjustable, flare nut, striking, slugging, spanner and ... you get the point. Most of these

incorporate time (and knuckle) saving features like Anti-Slip Design™ technology on open ends and

TorquePlus™ drive configurations on box ends. And all wrenches are forged, polished and finished to last.

WRENCHES



Full Polish Anti-Slip Combination Wrenches

PROTO

ENGINEERED FOR INDUSTRY

Proto® offers a wide range of sizes for many types of ends, with innovations like ratcheting splines and flex-head sockets. We also offer a wide range of angled and bent offsets to meet specific job applications.

Chrome plating to aerospace standards where applicable.

Precision broached for tight tolerances.

Premium alloy steel for strength.

Anti-Slip Design locks the fastener into place.

ASD increases the applied force to the flat of the fastener and away from corners.

FINISHES AVAILABLE



Polish Chrome Satin Chrome Black Oxide Black Chrome

DIFFERENT KINDS OF OFFSETS

- › **Angled Offsets:** The end lies flat with the handle, and the end turns either left or right.
- › **Bent Offsets:** The end is centered with the handle, but bent. The end does not lie flat.
- › **Deep Offsets:** Two bends offset the handle away from the end for better clearance.

DIFFERENT KINDS OF ENDS



WRENCH GUIDE

COMBINATION WRENCHES

Same sizes of two different types.



DOUBLE BOX AND OPEN END WRENCHES

Two different sizes of the same type.



RATCHETING WRENCHES

Reversables have an offset. Non-Reversables are flat.



CROWFOOT WRENCHES

With locking extensions to reach around obstacles.



PIPE WRENCHES

Available in Aluminum and Cast Iron.



STRIKING WRENCHES

Hit them with a hammer. Available with flat or offset ends.



ADJUSTABLE WRENCHES

Featuring Klik-Stop®. The wrench clicks at different sizings so you can feel your adjustments without looking.



INSULATED WRENCHES

Insulated to 1000V AC or 1500V DC.



X-LARGE WRENCHES

For work on oversized equipment.

FULL POLISH COMBINATION REVERSIBLE RATCHETING WRENCHES - SPLINE

Delayed Availability

- › Anti-Slip Design (ASD) open end.
- › Smooth transition from head to shank.
- › Industrial strength I-Beam shank provides broad bearing surface helping improve comfort and helping reduce hand fatigue.
- › Protected switch lever helps prevent accidental reversal.
- › Compact ratcheting head improves access.
- › 72-teeth provide 5° ratcheting.



| Product # | Size (in) | Throat Depth (in) (B) | Outside Head Width (in) (C) | Head Thickness (in) (D) | Outside Head Width (in) (C1) | Head Thickness (in) (D1) | Overall Length (in) | Weight (lbs) |
|-----------|-----------|-----------------------|-----------------------------|-------------------------|------------------------------|--------------------------|---------------------|--------------|
| JSCV08A | 1/4 | 5/16 | 35/64 | 5/32 | 35/64 | 1/4 | 4-59/64 | 0.05 |
| JSCV09A | 9/32 | 5/16 | 39/64 | 11/64 | 43/64 | 1/4 | 5-5/32 | 0.07 |
| JSCV10A | 5/16 | 25/64 | 11/16 | 11/64 | 43/64 | 1/4 | 5-27/64 | 0.08 |
| JSCV11A | 11/32 | 13/32 | 25/32 | 3/16 | 3/4 | 17/64 | 5-43/64 | 0.10 |
| JSCV12A | 3/8 | 29/64 | 27/32 | 13/64 | 25/32 | 9/32 | 5-29/32 | 0.12 |
| JSCV14A | 7/16 | 1/2 | 15/16 | 7/32 | 55/64 | 19/64 | 6-29/32 | 0.16 |
| JSCV16A | 1/2 | 39/64 | 1-5/64 | 1/4 | 1 | 11/32 | 7-29/32 | 0.24 |
| JSCV18A | 9/16 | 11/16 | 1-13/64 | 9/32 | 1-5/64 | 23/64 | 8-49/64 | 0.30 |
| JSCV20A | 5/8 | 3/4 | 1-21/64 | 19/64 | 1-3/16 | 25/64 | 9-33/64 | 0.40 |
| JSCV22A | 11/16 | 53/64 | 1-7/16 | 5/16 | 1-1/4 | 13/32 | 10-17/64 | 0.49 |
| JSCV24A | 3/4 | 29/32 | 1-37/64 | 11/32 | 1-21/64 | 7/16 | 11-3/64 | 0.60 |
| JSCV26A | 13/16 | 31/32 | 1-23/32 | 23/64 | 1-37/64 | 33/64 | 11-13/16 | 0.80 |
| JSCV28A | 7/8 | 1-3/64 | 1-7/8 | 3/8 | 1-37/64 | 33/64 | 12-35/64 | 0.86 |
| JSCV30A | 15/16 | 1-1/8 | 1-31/32 | 25/64 | 1-53/64 | 37/64 | 13-5/16 | 1.09 |
| JSCV32A | 1 | 1-13/64 | 2-3/32 | 27/64 | 1-53/64 | 37/64 | 14-1/16 | 1.17 |
| JSCV34A | 1-1/16 | 1-9/32 | 2-7/32 | 15/32 | 2-3/64 | 39/64 | 14-15/16 | 1.44 |
| JSCV36A | 1-1/8 | 1-23/64 | 2-11/32 | 1/2 | 2-9/32 | 43/64 | 15-7/8 | 1.85 |
| JSCV40A | 1-1/4 | 1-1/2 | 2-19/32 | 35/64 | 2-15/32 | 11/16 | 16-59/64 | 2.29 |

THE STORY BEHIND THE OFFSET OPEN END



A standard combination wrench gets stuck.



The Proto® Wrench with the Offset Open End still has 10 - 12° of turning angle.

Reaching a fastener behind an obstruction is frustrating, especially when you can reach it with the wrench, but you can't turn the wrench.

Rethinking the standard combination wrench allowed Proto® engineers to discover a better way reach and turn something in a difficult place.

By turning the open end to an angle, the patented Offset Open End has an improved angle of attack onto the fastener. It can squeeze an extra 10 to 12 degrees of turning angle when obstructions are nearby.

FULL POLISH METRIC COMBINATION REVERSIBLE RATCHETING WRENCHES - SPLINE

METRIC
Delayed Availability

- › Anti-Slip Design (ASD) open end.
- › Smooth transition from head to shank.
- › Industrial strength I-Beam shank provides broad bearing surface helping improve comfort and helping reduce hand fatigue.
- › Protected switch lever helps prevent accidental reversal.
- › Compact ratcheting head improves access.
- › 72-teeth provide 5° ratcheting.



| Product # | Size (mm) | Throat Depth (in) (B) | Outside Head Width (in) (C) | Head Thickness (in) (D) | Outside Head Width (in) (C1) | Head Thickness (in) (D1) | Overall Length (in) | Weight (lbs) |
|-----------|-----------|-----------------------|-----------------------------|-------------------------|------------------------------|--------------------------|---------------------|--------------|
| JSCVM06A | 6 | 5/16 | 35/64 | 5/32 | 35/64 | 1/4 | 4-59/64 | 0.05 |
| JSCVM07A | 7 | 5/16 | 39/64 | 11/64 | 43/64 | 1/4 | 5-5/32 | 0.07 |
| JSCVM08A | 8 | 25/64 | 11/16 | 11/64 | 43/64 | 1/4 | 5-27/64 | 0.08 |
| JSCVM09A | 9 | 13/32 | 25/32 | 3/16 | 3/4 | 17/64 | 5-43/64 | 0.10 |
| JSCVM10A | 10 | 29/64 | 27/32 | 13/64 | 25/32 | 9/32 | 5-29/32 | 0.12 |
| JSCVM11A | 11 | 1/2 | 15/16 | 7/32 | 55/64 | 19/64 | 6-29/32 | 0.16 |
| JSCVM12A | 12 | 35/64 | 1-1/64 | 15/64 | 29/32 | 21/64 | 7-23/32 | 0.20 |
| JSCVM13A | 13 | 39/64 | 1-5/64 | 1/4 | 1 | 11/32 | 7-29/32 | 0.24 |
| JSCVM14A | 14 | 11/16 | 1-13/64 | 9/32 | 1-5/64 | 23/64 | 8-49/64 | 0.30 |
| JSCVM15A | 15 | 23/32 | 1-17/64 | 9/32 | 1-7/64 | 3/8 | 9-9/64 | 0.34 |
| JSCVM16A | 16 | 3/4 | 1-21/64 | 19/64 | 1-3/16 | 25/64 | 9-33/64 | 0.40 |
| JSCVM17A | 17 | 53/64 | 1-7/16 | 5/16 | 1-1/4 | 13/32 | 10-17/64 | 0.49 |
| JSCVM18A | 18 | 55/64 | 1-33/64 | 21/64 | 1-9/32 | 27/64 | 10-11/16 | 0.55 |
| JSCVM19A | 19 | 29/32 | 1-37/64 | 11/32 | 1-21/64 | 7/16 | 11-3/64 | 0.60 |
| JSCVM21A | 21 | 31/32 | 1-23/32 | 23/64 | 1-37/64 | 33/64 | 11-13/16 | 0.80 |
| JSCVM22A | 22 | 1-3/64 | 1-7/8 | 3/8 | 1-37/64 | 33/64 | 12-35/64 | 0.86 |
| JSCVM24A | 24 | 1-1/8 | 1-31/32 | 25/64 | 1-53/64 | 37/64 | 13-5/16 | 1.09 |
| JSCVM27A | 27 | 1-9/32 | 2-7/32 | 15/32 | 2-3/64 | 39/64 | 14-15/16 | 1.44 |
| JSCVM30A | 30 | 1-23/64 | 2-11/32 | 1/2 | 2-9/32 | 43/64 | 15-7/8 | 1.85 |
| JSCVM32A | 32 | 1-1/2 | 2-19/32 | 35/64 | 2-15/32 | 11/16 | 16-59/64 | 2.29 |

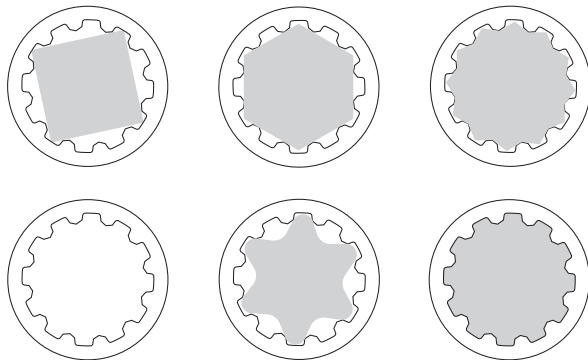

Versatile usages on 4pt, 6pt, 12pt, spline, Torx®, and slightly rounded fasteners.

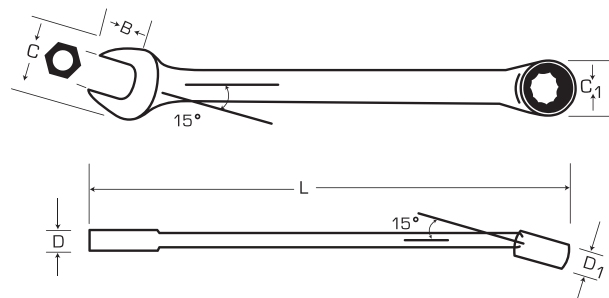

20 PIECE REVERSIBLE COMBINATION RATCHETING WRENCH SET - SPLINE

Product #: **JSCV-20S**

| Contents | Size (in) | Point Count | Overall Length (in) |
|----------|-----------|-------------|---------------------|
| JSCV07 | 7/32 | Spline | 5 |
| JSCV08 | 1/4 | Spline | 5 |
| JSCV09 | 9/32 | Spline | 5-1/2 |
| JSCV10 | 5/16 | Spline | 5-1/2 |
| JSCV11 | 11/32 | Spline | 5-15/16 |
| JSCV12 | 3/8 | Spline | 6-1/4 |
| JSCV14 | 7/16 | Spline | 6-1/2 |
| JSCV16 | 1/2 | Spline | 7 |
| JSCV18 | 9/16 | Spline | 7-1/2 |
| JSCV20 | 5/8 | Spline | 8-3/16 |
| JSCV22 | 11/16 | Spline | 8-7/8 |
| JSCV24 | 3/4 | Spline | 9-3/4 |
| JSCV26 | 13/16 | Spline | 1-17/16 |
| JSCV28 | 7/8 | Spline | 1-17/16 |
| JSCV30 | 15/16 | Spline | 12-3/4 |
| JSCV32 | 1 | Spline | 12-3/4 |
| JSCV34 | 1-1/16 | Spline | 14-1/8 |
| JSCV36 | 1-1/8 | Spline | 15-7/8 |
| JSCV40 | 1-1/4 | Spline | 16-3/4 |
| JSCV48 | 1-1/2 | Spline | 19-5/16 |
| JSCV20SP | Tool Roll | | |

- ▶ Black chrome finish is corrosion resistant and visually distinctive.
- ▶ Fractional spline wrenches can be used on fractional 4, 6, 12 point, spline and Torx® fasteners.
- ▶ The chrome-vanadium switch lever allows for easy changes in turning direction which helps improve speed.
- ▶ 15° angled offset box end helps keep shank clear of obstructions.
- ▶ Anti-Slip Design (ASD) open end.
- ▶ Weight (lbs): 16.20



22 PIECE METRIC REVERSIBLE COMBINATION RATCHETING WRENCH SET - SPLINE

METRIC

Product #: **JSCVM-22S**

| Contents | Size (mm) | Point Count | Overall Length (in) |
|-----------|-----------|-------------|---------------------|
| JSCVM06 | 6 | Spline | 5 |
| JSCVM07 | 7 | Spline | 5-1/2 |
| JSCVM08 | 8 | Spline | 5-1/2 |
| JSCVM09 | 9 | Spline | 5-15/16 |
| JSCVM10 | 10 | Spline | 6-1/4 |
| JSCVM11 | 11 | Spline | 6-9/16 |
| JSCVM12 | 12 | Spline | 6-3/4 |
| JSCVM13 | 13 | Spline | 7 |
| JSCVM14 | 14 | Spline | 7-1/2 |
| JSCVM15 | 15 | Spline | 7-7/8 |
| JSCVM16 | 16 | Spline | 8-3/16 |
| JSCVM17 | 17 | Spline | 8-7/8 |
| JSCVM18 | 18 | Spline | 9-5/16 |
| JSCVM19 | 19 | Spline | 9-3/4 |
| JSCVM21 | 21 | Spline | 11-7/16 |
| JSCVM22 | 22 | Spline | 11-7/16 |
| JSCVM24 | 24 | Spline | 12-3/4 |
| JSCVM27 | 27 | Spline | 14-1/8 |
| JSCVM30 | 30 | Spline | 15-7/8 |
| JSCVM32 | 32 | Spline | 16-3/4 |
| JSCVM34 | 34 | Spline | 18-1/8 |
| JSCVM36 | 36 | Spline | 19-5/16 |
| JSCVM22SP | Tool Roll | | |

- ▶ Metric Spline wrenches can be used on metric 4, 6, 12 point, spline and Torx® fasteners.
- ▶ The chrome-vanadium switch lever allows for easy changes in turning direction which helps improve speed.
- ▶ 15° angled offset box end helps keep shank clear of obstructions.
- ▶ Chrome-vanadium box ends and switch levers provide high strength and durability.
- ▶ Box end is countersunk for easy application to the fastener.
- ▶ Spline design was created for use with speciality spline bolts which are used when weight and size of bolt heads must be minimized.
- ▶ Spline design enables the wrench to contact conventional fasteners away from the corners, which applies force over a larger area, reducing risk of fastener scoring and helps prevent rounding of the corners and other fasteners damage that could lead to Foreign Object Damage (FOD).
- ▶ The high contact surface area which is away from fastener points enables turning of highly rounded fasteners.
- ▶ Anti-Slip Design (ASD) open end.
- ▶ Black chrome finish is corrosion resistant and visually distinctive.
- ▶ Weight (lbs): 17.10



13 PIECE METRIC REVERSIBLE COMBINATION RATCHETING WRENCH SET - SPLINE

METRIC

Product #: **JSCVM-13S**

- › Metric Spline wrenches can be used on metric 4, 6, 12 point, spline and Torx® fasteners.
- › The chrome-vanadium switch lever allows for easy changes in turning direction which helps improve speed.
- › 15° angled offset box end helps keep shank clear of obstructions.
- › Chrome-vanadium box ends and switch levers provide high strength and durability.
- › Box end is countersunk for easy application to the fastener.
- › Spline design was created for use with speciality spline bolts which are used when weight and size of bolt heads must be minimized.
- › Spline design enables the wrench to contact conventional fasteners away from the corners, which applies force over a larger area, reducing risk of fastener scoring and helps prevent rounding of the corners and other fasteners damage that could lead to Foreign Object Damage (FOD).
- › The high contact surface area which is away from fastener points enables turning of highly rounded fasteners.
- › Anti-Slip Design (ASD) open end.
- › Black chrome finish is corrosion resistant and visually distinctive.
- › Weight (lbs): 3.02

| Contents | Size (mm) | Point Count | Overall Length (in) |
|-----------|-----------|-------------|---------------------|
| JSCVM07 | 7 | Spline | 5-1/2 |
| JSCVM08 | 8 | Spline | 5-1/2 |
| JSCVM09 | 9 | Spline | 5-15/16 |
| JSCVM10 | 10 | Spline | 6-1/4 |
| JSCVM11 | 11 | Spline | 6-9/16 |
| JSCVM12 | 12 | Spline | 6-3/4 |
| JSCVM13 | 13 | Spline | 7 |
| JSCVM14 | 14 | Spline | 7-1/2 |
| JSCVM15 | 15 | Spline | 7-7/8 |
| JSCVM16 | 16 | Spline | 8-3/16 |
| JSCVM17 | 17 | Spline | 8-7/8 |
| JSCVM18 | 18 | Spline | 9-5/16 |
| JSCVM19 | 19 | Spline | 9-3/4 |
| JSCVM13SP | Tool Roll | | |



9 PIECE REVERSIBLE COMBINATION RATCHETING WRENCH SET - SPLINE

Product #: **JSCV-9S**

- › Black chrome finish is corrosion resistant and visually distinctive.
- › Fractional spline wrenches can be used on fractional 4, 6, 12 point, spline fasteners and Torx® fasteners.
- › The chrome-vanadium switch lever allows for easy changes in turning direction which helps improve speed.
- › 15° angled offset box end helps keep shank clear of obstructions.
- › Anti-Slip Design (ASD) open end.
- › Weight (lbs): 1.90

| Contents | Size (in) | Point Size | Overall Length (in) |
|----------|-----------|------------|---------------------|
| JSCV09 | 9/32 | Spline | 5-1/2 |
| JSCV10 | 5/16 | Spline | 5-1/2 |
| JSCV12 | 3/8 | Spline | 6-1/4 |
| JSCV14 | 7/16 | Spline | 6-1/2 |
| JSCV16 | 1/2 | Spline | 7 |
| JSCV18 | 9/16 | Spline | 7-1/2 |
| JSCV20 | 5/8 | Spline | 8-3/16 |
| JSCV22 | 11/16 | Spline | 8-7/8 |
| JSCV24 | 3/4 | Spline | 9-3/4 |
| JSCV9SP | Tool Roll | | |



BLACK CHROME COMBINATION REVERSIBLE RATCHETING WRENCHES - SPLINE

- › Fractional spline wrenches can be used on fractional 4, 6, 12 point, spline and Torx® fasteners.
- › The chrome-vanadium switch lever allows for easy changes in turning direction which helps improve speed.
- › 15° angled offset box end helps keep shank clear of obstructions.
- › Chrome-vanadium box ends and switch levers provide high strength and durability.
- › Box end is countersunk for easy application to the fastener.
- › Spline design was created for use with specialty spline bolts which are used when weight and size of bolt heads must be minimized.
- › Spline design enables the wrench to contact conventional fasteners away from the corners, which applies force over a larger area, reducing risk of fastener scoring and helps prevent rounding of the corners and other fasteners damage that could lead to Foreign Object Damage (FOD).
- › The high contact surface area which is away from fastener points enables turning of highly rounded fasteners.
- › Anti-Slip Design (ASD) open end.
- › Black chrome finish is corrosion resistant and visually distinctive.



| Product # | Size (in) | Outside Head Width (in) (C) | Head Thickness (in) (D) | Head Thickness (in) (D1) | Overall Length (in) | Weight (lbs) |
|-----------|-----------|-----------------------------|-------------------------|--------------------------|---------------------|--------------|
| JSCV07 | 7/32 | 9/16 | 1/8 | 1/8 | 5 | 0.06 |
| JSCV08 | 1/4 | 9/16 | 1/8 | 1/8 | 5 | 0.06 |
| JSCV09 | 9/32 | 11/16 | 1/8 | 1/8 | 5-1/2 | 0.07 |
| JSCV10 | 5/16 | 11/16 | 1/8 | 1/8 | 5-1/2 | 0.07 |
| JSCV11 | 11/32 | 3/4 | 1/8 | 1/8 | 5-15/16 | 0.09 |
| JSCV12 | 3/8 | 13/16 | 1/8 | 1/8 | 6-1/4 | 0.11 |
| JSCV14 | 7/16 | 15/16 | 1/8 | 1/8 | 6-1/2 | 0.14 |
| JSCV16 | 1/2 | 1-1/16 | 3/16 | 3/16 | 7 | 0.20 |
| JSCV18 | 9/16 | 1-1/8 | 3/16 | 3/16 | 7-1/2 | 0.22 |
| JSCV20 | 5/8 | 1-5/16 | 3/16 | 3/16 | 8-3/16 | 0.33 |
| JSCV22 | 11/16 | 1-3/8 | 3/16 | 3/16 | 8-7/8 | 0.37 |
| JSCV24 | 3/4 | 1-9/16 | 1/4 | 1/4 | 9-3/4 | 0.48 |
| JSCV26 | 13/16 | 1-13/16 | 1/4 | 1/4 | 1-17/16 | 0.77 |
| JSCV28 | 7/8 | 1-13/16 | 1/4 | 1/4 | 1-17/16 | 0.73 |
| JSCV30 | 15/16 | 2-1/16 | 1/4 | 1/4 | 12-3/4 | 1.02 |
| JSCV32 | 1 | 2-1/16 | 1/4 | 1/4 | 12-3/4 | 1.00 |
| JSCV34 | 1-1/16 | 2-1/4 | 5/16 | 5/16 | 14-1/8 | 1.45 |
| JSCV36 | 1-1/8 | 2-5/16 | 5/16 | 5/16 | 15-7/8 | 1.96 |
| JSCV40 | 1-1/4 | 2-1/2 | 5/16 | 5/16 | 16-3/4 | 2.30 |
| JSCV48 | 1-1/2 | 2-13/16 | 3/8 | 3/8 | 19-5/16 | 3.09 |

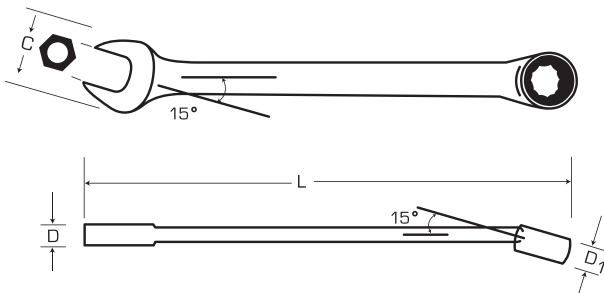

BLACK CHROME METRIC COMBINATION REVERSIBLE RATCHETING WRENCHES - SPLINE

METRIC

- › Metric Spline wrenches can be used on metric 4, 6, 12 point, spline and Torx® fasteners.
- › The chrome-vanadium switch lever allows for easy changes in turning direction which helps improve speed.
- › 15° angled offset box end helps keep shank clear of obstructions.
- › Chrome-vanadium box ends and switch levers provide high strength and durability.
- › Box end is countersunk for easy application to the fastener.
- › Spline design was created for use with specialty spline bolts which are used when weight and size of bolt heads must be minimized.
- › Spline design enables the wrench to contact conventional fasteners away from the corners, which applies force over a larger area, reducing risk of fastener scoring and helps prevent rounding of the corners and other fasteners damage that could lead to Foreign Object Damage (FOD).
- › The high contact surface area which is away from fastener points enables turning of highly rounded fasteners.
- › Anti-Slip Design (ASD) open end.
- › Black chrome finish is corrosion resistant and visually distinctive.



WRENCHES



RATCHETING

| Product # | Size (mm) | Outside Head Width (in) (C) | Head Thickness (in) (D) | Head Thickness (in) (D1) | Overall Length (in) | Weight (lbs) |
|-----------|-----------|-----------------------------|-------------------------|--------------------------|---------------------|--------------|
| JSCVM06 | 6 | 9/16 | 1/8 | 1/8 | 5 | 0.06 |
| JSCVM07 | 7 | 11/16 | 1/8 | 1/8 | 5-1/2 | 0.07 |
| JSCVM08 | 8 | 11/16 | 1/8 | 1/8 | 5-1/2 | 0.07 |
| JSCVM09 | 9 | 3/4 | 1/8 | 1/8 | 5-15/16 | 0.09 |
| JSCVM10 | 10 | 13/16 | 1/8 | 1/8 | 6-1/4 | 0.11 |
| JSCVM11 | 11 | 15/16 | 1/8 | 1/8 | 6-9/16 | 0.14 |
| JSCVM12 | 12 | 1 | 3/16 | 3/16 | 6-3/4 | 0.17 |
| JSCVM13 | 13 | 1-11/16 | 3/16 | 3/16 | 7 | 0.20 |
| JSCVM14 | 14 | 1-1/8 | 3/16 | 3/16 | 7-1/2 | 0.24 |
| JSCVM15 | 15 | 1-1/4 | 3/16 | 3/16 | 7-7/8 | 0.28 |
| JSCVM16 | 16 | 1-5/16 | 3/16 | 3/16 | 8-3/16 | 0.33 |
| JSCVM17 | 17 | 1-3/8 | 3/16 | 3/16 | 8-7/8 | 0.39 |
| JSCVM18 | 18 | 1-1/2 | 3/16 | 3/16 | 9-5/16 | 0.43 |
| JSCVM19 | 19 | 1-9/16 | 1/4 | 1/4 | 9-3/4 | 0.50 |
| JSCVM21 | 21 | 1-13/16 | 1/4 | 1/4 | 11-7/16 | 0.76 |
| JSCVM22 | 22 | 1-13/16 | 1/4 | 1/4 | 11-7/16 | 0.76 |
| JSCVM24 | 24 | 2-1/16 | 1/4 | 1/4 | 12-3/4 | 1.06 |
| JSCVM27 | 27 | 2-1/4 | 5/16 | 5/16 | 14-1/8 | 1.42 |
| JSCVM30 | 30 | 2-5/16 | 5/16 | 5/16 | 15-7/8 | 1.89 |
| JSCVM32 | 32 | 2-1/2 | 5/16 | 5/16 | 16-3/4 | 2.32 |
| JSCVM34 | 34 | 2-1/2 | 3/8 | 3/8 | 18-1/8 | 2.65 |
| JSCVM36 | 36 | 2-13/16 | 3/8 | 3/8 | 19-5/16 | 3.09 |

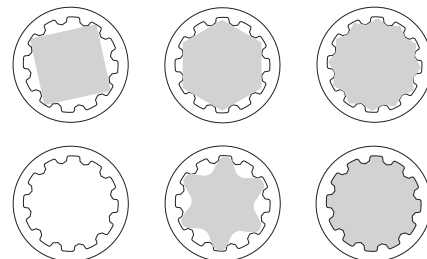

Versatile usages on 4pt, 6pt, 12pt, spline, Torx®, and slightly rounded fasteners.



9 PIECE NON-REVERSIBLE COMBINATION WRENCH SET - SPLINE

Product #: JSCR-9S

- › Black chrome finish is corrosion resistant and visually distinctive.
- › Non-reversing ratcheting wrenches can be flipped over to turn the fastener in the opposite direction.
- › Ratcheting spline box end is countersunk for easy application to the fastener.
- › Spline design was created for use with specialty spline bolts which are used when weight and size of bolt heads must be minimized.
- › Spline design enables the wrench to contact conventional fasteners away from the corners, which help apply force over a large area helping to reduce risk of fastener rounding.
- › Spline design also helps prevent rounding of corners and other fastener damage that could lead to Foreign Object Damage (FOD).
- › The high contact surface area which is away from fastener points enables turning of highly rounded fasteners.
- › Anti-Slip Design (ASD) open end.
- › Fractional spline wrenches can be used on fractional 4, 6, 12 point, spline and Torx® fasteners.
- › Weight (lbs): 2.71

| Contents | Size (in) | Point Count | Overall Length (in) |
|----------|-----------|-------------|---------------------|
| JSCR08 | 1/4 | Spline | 5 |
| JSCR10 | 5/16 | Spline | 5-1/2 |
| JSCR12 | 3/8 | Spline | 6-1/4 |
| JSCR14 | 7/16 | Spline | 6-1/2 |
| JSCR16 | 1/2 | Spline | 7 |
| JSCR18 | 9/16 | Spline | 7-1/2 |
| JSCR20 | 5/8 | Spline | 8-3/16 |
| JSCR22 | 11/16 | Spline | 8-7/8 |
| JSCR24 | 3/4 | Spline | 9-3/4 |
| JSCR9SP | Tool Roll | | |



10 PIECE METRIC NON-REVERSIBLE COMBINATION WRENCH SET - SPLINE

METRIC

Product #: JSCRM-10S

- › Metric Spline wrenches can be used on metric 4, 6, 12 point, spline and Torx® fasteners.
- › The chrome-vanadium switch lever allows for easy changes in turning direction which helps improve speed.
- › 15° angled offset box end helps keep shank clear of obstructions.
- › Chrome-vanadium box ends and switch levers provide high strength and durability.
- › Box end is countersunk for easy application to the fastener.
- › Spline design was created for use with speciality spline bolts which are used when weight and size of bolt heads must be minimized.
- › Spline design enables the wrench to contact conventional fasteners away from the corners, which applies force over a larger area, reducing risk of fastener scoring and helps prevent rounding of the corners and other fasteners damage that could lead to Foreign Object Damage (FOD).
- › The high contact surface area which is away from fastener points enables turning of highly rounded fasteners.
- › Anti-Slip Design (ASD) open end.
- › Black chrome finish is corrosion resistant and visually distinctive.
- › Weight (lbs): 2.71

| Contents | Size (mm) | Point Count | Overall Length (in) |
|-----------|-----------|-------------|---------------------|
| JSCRM10 | 10 | Spline | 6-1/4 |
| JSCRM11 | 11 | Spline | 6-1/2 |
| JSCRM12 | 12 | Spline | 6-3/4 |
| JSCRM13 | 13 | Spline | 7 |
| JSCRM14 | 14 | Spline | 7-1/2 |
| JSCRM15 | 15 | Spline | 7-7/8 |
| JSCRM16 | 16 | Spline | 8-3/16 |
| JSCRM17 | 17 | Spline | 8-7/8 |
| JSCRM18 | 18 | Spline | 9-5/16 |
| JSCRM19 | 19 | Spline | 9-3/4 |
| JSCRM10SP | Tool Roll | | |



BLACK CHROME COMBINATION NON-REVERSIBLE RATCHETING WRENCHES - SPLINE

- › Fractional spline wrenches can be used on fractional 4, 6, 12 point, spline and Torx® fasteners.
- › The chrome-vanadium switch lever allows for easy changes in turning direction which helps improve speed.
- › 15° angled offset box end helps keep shank clear of obstructions.
- › Chrome-vanadium box ends and switch levers provide high strength and durability.
- › Box end is countersunk for easy application to the fastener.
- › Spline design was created for use with speciality spline bolts which are used when weight and size of bolt heads must be minimized.
- › Spline design enables the wrench to contact conventional fasteners away from the corners, which applies force over a larger area, reducing risk of fastener scoring and helps prevent rounding of the corners and other fasteners damage that could lead to Foreign Object Damage (FOD).
- › The high contact surface area which is away from fastener points enables turning of highly rounded fasteners.
- › Anti-Slip Design (ASD) open end.
- › Black chrome finish is corrosion resistant and visually distinctive.



| Product # | Size (in) | Outside Head Width (in) (C) | Head Thickness (in) (D) | Head Thickness (in) (D1) | Overall Length (in) | Weight (lbs) |
|-----------|-----------|-----------------------------|-------------------------|--------------------------|---------------------|--------------|
| JSCR08 | 1/4 | 9/16 | 1/8 | 1/8 | 5 | 0.05 |
| JSCR10 | 5/16 | 11/16 | 1/8 | 1/8 | 5-1/2 | 0.06 |
| JSCR11 | 11/32 | 3/4 | 1/8 | 1/8 | 5-15/16 | 0.08 |
| JSCR12 | 3/8 | 13/16 | 1/8 | 1/8 | 6-1/4 | 0.10 |
| JSCR14 | 7/16 | 15/16 | 1/8 | 1/8 | 6-1/2 | 0.13 |
| JSCR16 | 1/2 | 1-1/16 | 3/16 | 3/16 | 7 | 0.18 |
| JSCR18 | 9/16 | 1-1/8 | 3/16 | 3/16 | 7-1/2 | 0.22 |
| JSCR20 | 5/8 | 1-5/16 | 3/16 | 3/16 | 8-3/16 | 0.32 |
| JSCR22 | 11/16 | 1-3/8 | 3/16 | 3/16 | 8-7/8 | 0.38 |
| JSCR24 | 3/4 | 1-9/16 | 1/4 | 1/4 | 9-3/4 | 0.47 |
| JSCR26 | 13/16 | 1-13/16 | 1/4 | 1/4 | 11-7/16 | 0.70 |
| JSCR28 | 7/8 | 1-13/16 | 1/4 | 1/4 | 11-7/16 | 0.70 |
| JSCR30 | 15/16 | 2-1/16 | 1/4 | 1/4 | 12-3/4 | 1.02 |
| JSCR32 | 1 | 2-1/16 | 1/4 | 1/4 | 12-3/4 | 1.02 |

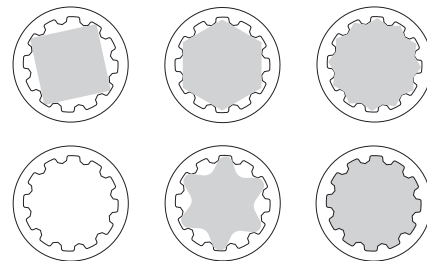
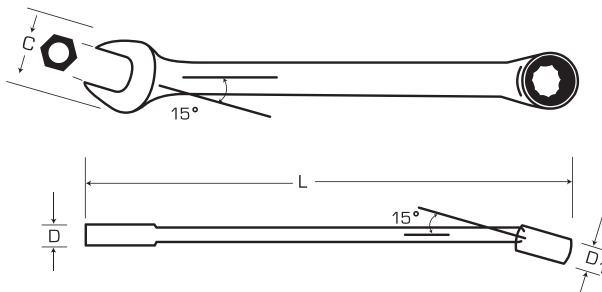

Versatile usages on 4pt, 6pt, 12pt, spline, Torx®, and slightly rounded fasteners.

BLACK CHROME METRIC COMBINATION NON-REVERSIBLE RATCHETING WRENCHES - SPLINE

METRIC

- › Metric Spline wrenches can be used on metric 4, 6, 12 point, spline and Torx® fasteners.
- › The chrome-vanadium switch lever allows for easy changes in turning direction which helps improve speed.
- › 15° angled offset box end helps keep shank clear of obstructions.
- › Chrome-vanadium box ends and switch levers provide high strength and durability.
- › Box end is countersunk for easy application to the fastener.
- › Spline design was created for use with specialty spline bolts which are used when weight and size of bolt heads must be minimized.
- › Spline design enables the wrench to contact conventional fasteners away from the corners, which applies force over a larger area, reducing risk of fastener scoring and helps prevent rounding of the corners and other fasteners damage that could lead to Foreign Object Damage (FOD).
- › The high contact surface area which is away from fastener points enables turning of highly rounded fasteners.
- › Anti-Slip Design (ASD) open end.
- › Black chrome finish is corrosion resistant and visually distinctive.



| Product # | Size (mm) | Outside Head Width (in) (C) | Head Thickness (in) (D) | Head Thickness (in) (D1) | Overall Length (in) | Weight (lbs) |
|-----------|-----------|-----------------------------|-------------------------|--------------------------|---------------------|--------------|
| JSCRM08 | 8 | 11/16 | 1/8 | 1/8 | 5-1/2 | 0.06 |
| JSCRM09 | 9 | 3/4 | 1/8 | 1/8 | 5-15/16 | 0.08 |
| JSCRM10 | 10 | 13/16 | 1/8 | 1/8 | 6-1/4 | 0.10 |
| JSCRM11 | 11 | 15/16 | 1/8 | 1/8 | 6-1/2 | 0.13 |
| JSCRM12 | 12 | 1 | 1/8 | 1/8 | 6-3/4 | 0.16 |
| JSCRM13 | 13 | 1-1/16 | 3/16 | 3/16 | 7 | 0.18 |
| JSCRM14 | 14 | 1-1/8 | 3/16 | 3/16 | 7-1/2 | 0.22 |
| JSCRM15 | 15 | 1-1/4 | 3/16 | 3/16 | 7-7/8 | 0.25 |
| JSCRM16 | 16 | 1-5/16 | 3/16 | 3/16 | 8-3/16 | 0.32 |
| JSCRM17 | 17 | 1-7/16 | 3/16 | 3/16 | 8-7/8 | 0.38 |
| JSCRM18 | 18 | 1-1/2 | 3/16 | 3/16 | 9-5/16 | 0.46 |
| JSCRM19 | 19 | 1-9/16 | 1/4 | 1/4 | 9-3/4 | 0.47 |

8 PIECE DOUBLE BOX REVERSIBLE RATCHETING WRENCH SET - SPLINE

Product #: **JSBV-8S**

- › Black chrome finish is corrosion resistant and visually distinctive.
- › Non-reversing ratcheting wrenches can be flipped over to turn the fastener in the opposite direction.
- › Ratcheting spline box end is countersunk for easy application to the fastener.
- › Spline design was created for use with specialty spline bolts which are used when weight and size of bolt heads must be minimized.
- › Spline design enables the wrench to contact conventional fasteners away from the corners, which help apply force over a large area helping to reduce risk of fastener rounding.
- › Spline design also helps prevent rounding of corners and other fastener damage that could lead to Foreign Object Damage (FOD).
- › The fractional spline wrenches can be used on fractional 4, 6, 12 point and spline fasteners.
- › The high contact surface area which is away from fastener points enables turning of highly rounded fasteners.
- › Weight (lbs): 4.12

| Contents | Size (in) | Point Count | Overall Length (in) |
|----------|---------------|-------------|---------------------|
| JSBV0709 | 7/32 x 9/32 | Spline | 4-1/2 |
| JSBV0810 | 1/4 x 5/16 | Spline | 4-1/2 |
| JSBV1214 | 3/8 x 7/16 | Spline | 5-15/16 |
| JSBV1618 | 1/2 x 9/16 | Spline | 7-1/16 |
| JSBV2022 | 5/8 x 11/16 | Spline | 7-7/8 |
| JSBV2428 | 3/4 x 7/8 | Spline | 9-5/8 |
| JSBV2630 | 13/16 x 15/16 | Spline | 10-1/4 |
| JSBV3236 | 1 x 1-1/8 | Spline | 11-5/8 |
| JSBV8SP | Tool Roll | | |



BLACK CHROME DOUBLE BOX REVERSIBLE RATCHETING WRENCHES - SPLINE

- › Black chrome finish is corrosion resistant and visually distinctive.
- › Ratcheting spline box end is countersunk for easy application to the fastener.
- › Spline design was created for use with specialty spline bolts which are used when weight and size of bolt heads must be minimized.
- › Spline design enables the wrench to contact conventional fasteners away from the corners, which help apply force over a large area helping to reduce risk of fastener rounding.
- › Spline design also helps prevent rounding of corners and other fastener damage that could lead to Foreign Object Damage (FOD).
- › The fractional spline wrenches can be used on fractional 4, 6, 12 point and spline fasteners.
- › The high contact surface area which is away from fastener points enables turning of highly rounded fasteners.



| Product # | Size (in) | Outside Head Width (in) (C) | Head Thickness (in) (D) | Head Thickness (in) (D1) | Overall Length (in) | Weight (lbs) |
|-----------------|---------------|-----------------------------|-------------------------|--------------------------|---------------------|--------------|
| JSBV0709 | 7/32 x 9/32 | 11/16 | 1/8 | 1/8 | 4-1/2 | 0.08 |
| JSBV0810 | 1/4 x 5/16 | 11/16 | 1/8 | 1/8 | 4-1/2 | 0.08 |
| JSBV1214 | 3/8 x 7/16 | 7/8 | 1/8 | 1/8 | 5-15/16 | 0.12 |
| JSBV1618 | 1/2 x 9/16 | 1 | 3/16 | 3/16 | 7-1/16 | 0.23 |
| JSBV2022 | 5/8 x 11/16 | 1-3/16 | 3/16 | 3/16 | 7-7/8 | 0.35 |
| JSBV2428 | 3/4 x 7/8 | 1-5/8 | 1/4 | 1/4 | 9-5/8 | 0.63 |
| JSBV2630 | 13/16 x 15/16 | 1-13/16 | 1/4 | 1/4 | 10-1/4 | 0.84 |
| JSBV3236 | 1 x 1-1/8 | 2-5/16 | 5/16 | 5/16 | 11-5/8 | 0.95 |

4 PIECE RATCHETING WRENCH ADAPTER SET

Product #: **JHA4S**

- › Full polish finish provides corrosion resistance and easy clean surfaces.
- › Converts ratcheting wrench into super-thin ratchets or ratcheting bit drivers.
- › Inserts into box end with a stable locking and release mechanism.
- › Converts:
 - › 3/8" Ratcheting Wrench to 1/4" Drive Bit Adapter
 - › 3/8" Ratcheting Wrench to 1/4" Drive Adapter
 - › 1/2" Ratcheting Wrench to 3/8" Drive Adapter
 - › 3/4" Ratcheting Wrench to 1/2" Drive Adapter
- › Weight (lbs): 0.21



4 PIECE METRIC RATCHETING WRENCH ADAPTER SET



Product #: **JHAM4S**

- › Full polish finish provides corrosion resistance and easy clean surfaces.
- › Converts ratcheting wrench into super-thin ratchets or ratcheting bit drivers.
- › Inserts into box end with a stable locking and release mechanism.
- › Easy to read markings.
- › Converts:
 - › 10 mm Ratcheting Wrench to 1/4" Drive Bit Adapter
 - › 10 mm Ratcheting Wrench to 1/4" Drive Adapter
 - › 13 mm Ratcheting Wrench to 3/8" Drive Adapter
 - › 19 mm Ratcheting Wrench to 1/2" Drive Adapter
- › Weight (lbs): 0.22



5 PIECE OFFSET REVERSIBLE RATCHETING BOX WRENCH SET - 6 AND 12 POINT

Product #: **J1180A**

- › 25° offset box end helps keep shank clear of obstructions.
- › Shorter length for access to confined workspaces.
- › Reversing switch lever allows for easy changes in turning direction which helps improve speed.
- › Full polish finish on handle provides corrosion resistance and easy to clean surfaces.
- › 6 point box end allows for large wrench to fastener contact area which helps prevent rounding of the fastener.
- › 12 point box end allows for fine indexing, helping to improve speed and access.
- › Weight (lbs): 2.24

| Contents | Size (in) | Point Count | Overall Length (in) |
|----------|-------------|-------------|---------------------|
| J1181-A | 1/4 x 5/16 | 6 | 4-1/4 |
| J1182-A | 3/8 x 7/16 | 6 | 5-7/16 |
| J1183-A | 1/2 x 9/16 | 6 | 6-3/4 |
| J1184-A | 5/8 x 11/16 | 12 | 8 |
| J1185-A | 3/4 x 7/8 | 12 | 9-1/8 |
| J25TR06C | Tool Roll | | |



7 PIECE METRIC OFFSET RATCHETING BOX WRENCH SET - 6 AND 12 POINT

METRIC

Product #: **J1180MA**

- › Full polish finish provides corrosion resistance and easy to clean surfaces.
- › 12 point box end allows for fine indexing, helping to improve speed and access. Fits 4, 6 and 12 point fasteners.
- › 6 point box end allows larger wrench to fastener contact area which helps prevent rounding of the fastener.
- › 25° offset box end helps keep shank clear of obstructions.
- › Reversing switch lever allows for easy changes in turning direction which helps improve speed.
- › Weight (lbs): 3.60

| Contents | Size (mm) | Point Count | Overall Length (in) |
|-----------|-----------|-------------|---------------------|
| J1181M-A | 7 x 8 | 6 | 4-1/4 |
| J1182M-A | 9 x 10 | 6 | 5-7/16 |
| J1183MA-A | 11 x 13 | 6 | 6-3/4 |
| J1184MA-A | 12 x 14 | 6 | 6-3/4 |
| J1185M-A | 15 x 17 | 12 | 8 |
| J1186M-A | 16 x 18 | 12 | 8 |
| J1187M-A | 19 x 21 | 12 | 9-1/8 |
| J25TR01C | Tool Roll | | |



OFFSET REVERSIBLE RATCHETING DOUBLE BOX WRENCHES - 6 POINT

- › 25° offset box end helps keep shank clear of obstructions.
- › Shorter length for access to confined workspaces.
- › Reversing switch lever allows for easy changes in turning direction which helps improve speed.
- › Full polish finish on handle provides corrosion resistance and easy to clean surfaces.
- › 6 point box end allows for large wrench to fastener contact area which helps prevent rounding of the fastener.



| Product # | Size (in) | Outside Head Width (in) (C) | Head Thickness (in) (D) | Outside Head Width (in) (C1) | Head Thickness (in) (D1) | Overall Length (in) | Weight (lbs) |
|----------------|------------|-----------------------------|-------------------------|------------------------------|--------------------------|---------------------|--------------|
| J1181-A | 1/4 x 5/16 | 19/32 | 3/8 | 43/64 | 3/8 | 4-1/4 | 0.15 |
| J1182-A | 3/8 x 7/16 | 25/32 | 3/8 | 7/8 | 3/8 | 5-7/16 | 0.21 |
| J1183-A | 1/2 x 9/16 | 1 | 1/2 | 1-9/64 | 1/2 | 6-3/4 | 0.43 |

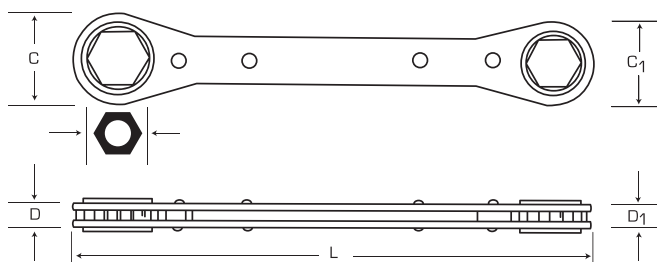

RATCHETING

METRIC OFFSET REVERSIBLE RATCHETING DOUBLE BOX WRENCHES - 6 POINT

METRIC

- › Full polish finish provides corrosion resistance and easy to clean surfaces.
- › 25° offset box end helps keep shank clear of obstructions.
- › Shorter length for access to confined workspaces.
- › 6 point box end allows larger wrench to fastener contact area which helps prevent rounding of the fastener.
- › Reversing switch lever allows for easy changes in turning direction which helps improve speed.
- › The wrench self-aligns with the fastener.



| Product # | Size (mm) | Outside Head Width (in) (C) | Head Thickness (in) (D) | Outside Head Width (in) (C1) | Head Thickness (in) (D1) | Overall Length (in) | Weight (lbs) |
|------------------|-----------|-----------------------------|-------------------------|------------------------------|--------------------------|---------------------|--------------|
| J1181M-A | 7 x 8 | 19/32 | 3/8 | 43/64 | 3/8 | 4-1/4 | 0.13 |
| J1182M-A | 9 x 10 | 25/32 | 3/8 | 7/8 | 3/8 | 5-7/16 | 0.22 |
| J1183MA-A | 11 x 13 | 1-1/64 | 1/2 | 1-5/32 | 1/2 | 6-3/4 | 0.32 |
| J1184MA-A | 12 x 14 | 1-1/64 | 1/2 | 1-5/32 | 1/2 | 6-3/4 | 0.32 |



OFFSET REVERSIBLE RATCHETING DOUBLE BOX WRENCHES - 12 POINT

- › Full polish finish provides corrosion resistance and easy to clean surfaces.
- › 25° offset box end helps keep shank clear of obstructions for greater accessibility.
- › Shorter length for access to confined workspaces.
- › Reversing switch lever allows for easy changes in turning direction which helps improve speed.
- › 12 point box end allows for fine indexing.
- › Fits 4, 6 and 12 point fasteners.



| Product # | Size (in) | Outside Head Width (in) (C) | Head Thickness (in) (D) | Outside Head Width (in) (C1) | Head Thickness (in) (D1) | Overall Length (in) | Weight (lbs) |
|-----------|-------------|-----------------------------|-------------------------|------------------------------|--------------------------|---------------------|--------------|
| J1179T | 7/32 x 9/32 | 19/32 | 3/8 | 43/64 | 3/8 | 4-1/4 | 0.15 |
| J1181T | 1/4 x 5/16 | 19/32 | 3/8 | 41/64 | 3/8 | 4-1/4 | 0.15 |
| J1182T | 3/8 x 7/16 | 25/32 | 3/8 | 7/8 | 3/8 | 5-7/16 | 0.21 |
| J1183T | 1/2 x 9/16 | 1 | 1/2 | 1-9/64 | 1/2 | 6-3/4 | 0.43 |
| J1184-A | 5/8 x 11/16 | 1-19/64 | 1/2 | 1-7/16 | 1/2 | 8 | 0.58 |
| J1185-A | 3/4 x 7/8 | 1-13/32 | 1/2 | 1-9/16 | 1/2 | 9-1/8 | 0.77 |
| J1186 | 5/8 x 3/4 | 1-19/64 | 1/2 | 1-7/16 | 1/2 | 8 | 0.58 |



METRIC OFFSET REVERSIBLE RATCHETING DOUBLE BOX WRENCHES - 12 POINT

METRIC

- › Full polish finish provides corrosion resistance and easy to clean surfaces.
- › Built in retaining ring in each ratchet wheel adds speed and convenience.
- › Shorter length for access to confined workspaces.
- › Reversing switch lever allows for easy changes in turning direction which helps improve speed.
- › The wrench self-aligns with the fastener.
- › 12 point box end allows for fine indexing.
- › Fits 4, 6 and 12 point fasteners.



| Product # | Size (mm) | Outside Head Width (in) (C) | Head Thickness (in) (D) | Outside Head Width (in) (C1) | Head Thickness (in) (D1) | Overall Length (in) | Weight (lbs) |
|-----------|-----------|-----------------------------|-------------------------|------------------------------|--------------------------|---------------------|--------------|
| J1185M-A | 15 x 17 | 1-19/64 | 1/2 | 1-7/16 | 1/2 | 8 | 0.46 |
| J1186M-A | 16 x 18 | 1-19/64 | 1/2 | 1-7/16 | 1/2 | 8 | 0.46 |
| J1187M-A | 19 x 21 | 1-13/32 | 1/2 | 1-37/64 | 1/2 | 9-1/8 | 0.52 |

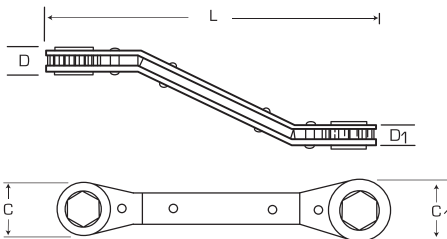

5 PIECE REVERSIBLE RATCHETING BOX WRENCH SET - 12 POINT

Product #: **J1190LO**

- › Full polish finish on handle provides corrosion resistance and easy to clean surfaces.
- › Built-in retaining ring in each ratchet wheel adds speed and convenience for greater accessibility.
- › Wrench self-aligns on the fastener which helps save time.
- › 12 point box end allows for fine indexing, helping improve speed and access.
- › Fits 4, 6 and 12 point fasteners.
- › Weight (lbs): 2.18

| Contents | Size (in) | Point Count | Overall Length (in) |
|----------|-------------|-------------|---------------------|
| J1191LO | 1/4 x 5/16 | 12 | 4-1/2 |
| J1192LO | 3/8 x 7/16 | 12 | 5-1/2 |
| J1193LO | 1/2 x 9/16 | 12 | 6-7/8 |
| J1194LO | 5/8 x 11/16 | 12 | 8-1/8 |
| J1195LO | 3/4 x 7/8 | 12 | 9-1/4 |
| J25TR06C | Tool Roll | | |



5 PIECE METRIC REVERSIBLE RATCHETING BOX WRENCH SET - 12 POINT

METRIC

Product #: **J1190MLO**

- › Full polish finish provides corrosion resistance and easy to clean surfaces.
- › Built in retaining ring in each ratchet wheel adds speed and convenience for greater accessibility.
- › Shorter length for access to confined workspaces.
- › Reversing switch lever allows for easy changes in turning direction which helps improve speed.
- › The wrench self-aligns with the fastener.
- › 12 point box end allows for fine indexing.
- › Fits 4, 6 and 12 point fasteners.
- › Weight (lbs): 2.03

| Contents | Size (mm) | Overall Length (in) |
|----------|-----------|---------------------|
| J1191MLO | 7 x 8 | 4-1/2 |
| J1192MLO | 9 x 10 | 5-1/2 |
| J1193MLO | 11 x 12 | 6-7/8 |
| J1194MLO | 13 x 14 | 6-7/8 |
| J1195MLO | 15 x 17 | 8-1/8 |
| J25TR06C | Tool Roll | |



REVERSIBLE RATCHETING DOUBLE BOX WRENCHES - 12 POINT

- › Full polish finish provides corrosion resistance and easy to clean surfaces.
- › Built in retaining ring in each ratchet wheel adds speed and convenience.
- › Shorter length for access to confined workspaces.
- › Reversing switch lever allows for easy changes in turning direction which helps improve speed.
- › The wrench self-aligns with the fastener.
- › 12 point box end allows for fine indexing.
- › Fits 4, 6 and 12 point fasteners.

| Product # | Size (in) | Overall Length | |
|-----------|-------------|----------------|--------------|
| | | (in) | Weight (lbs) |
| J1191LO | 1/4 x 5/16 | 4-1/2 | 0.15 |
| J1192LO | 3/8 x 7/16 | 5-1/2 | 0.21 |
| J1193LO | 1/2 x 9/16 | 6-7/8 | 0.31 |
| J1194LO | 5/8 x 11/16 | 8-1/8 | 0.58 |
| J1195LO | 3/4 x 7/8 | 9-1/4 | 0.67 |

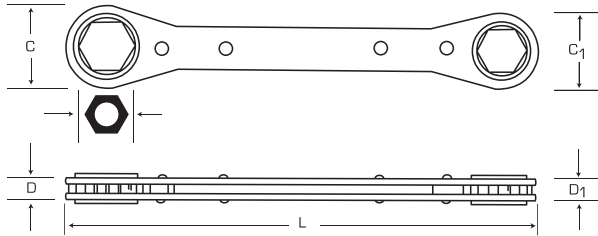

METRIC REVERSIBLE RATCHETING DOUBLE BOX WRENCHES - 12 POINT

- › Full polish finish provides corrosion resistance and easy to clean surfaces.
- › Built in retaining ring in each ratchet wheel adds speed and convenience for greater accessibility.
- › Shorter length for access to confined workspaces.
- › Reversing switch lever allows for easy changes in turning direction which helps improve speed.
- › The wrench self-aligns with the fastener.
- › 12 point box end allows for fine indexing.
- › Fits 4, 6 and 12 point fasteners.

METRIC

| Product # | Size (mm) | Overall Length | |
|-----------|-----------|----------------|--------------|
| | | (in) | Weight (lbs) |
| J1191MLO | 7 x 8 | 4-1/2 | 0.16 |
| J1192MLO | 9 x 10 | 5-1/2 | 0.23 |
| J1193MLO | 11 x 12 | 6-7/8 | 0.33 |
| J1194MLO | 13 x 14 | 6-7/8 | 0.61 |
| J1195MLO | 15 x 17 | 8-1/8 | 0.7 |



5 PIECE METRIC RATCHETING BOX WRENCH SET - 6 AND 12 POINT

Product #: **J1190MA**

METRIC

- › Full polish finish provides corrosion resistance and easy to clean surfaces.
- › Shorter length for access to confined workspaces.
- › The wrench self-aligns with the fastener.
- › 6 point box end allows for a large wrench to fastener contact area which helps prevent fastener rounding.
- › 12 point box end allows for fine indexing.
- › Fits 4, 6 and 12 point fasteners.
- › Weight (lbs): 2.12

| Contents | Size (mm) | Point Count | Overall Length (in) |
|-----------|-----------|-------------|---------------------|
| J1191M-A | 7 x 8 | 6 | 4-1/2 |
| J1192M-A | 9 x 10 | 6 | 5-1/2 |
| J1193MA-A | 11 x 13 | 6 | 6-7/8 |
| J1194MA-A | 12 x 14 | 6 | 6-7/8 |
| J1195M-A | 15 x 17 | 12 | 8-1/8 |
| J25TR06C | Tool Roll | | |



WRENCHES



5 PIECE RATCHETING BOX WRENCH SET - 12 POINT

Product #: **J1190A**

- › Full polish finish provides corrosion resistance and easy to clean surfaces.
- › Shorter length for access to confined workspaces.
- › The wrench self-aligns with the fastener.
- › 12 point box end allows for fine indexing.
- › Fits 4, 6 and 12 point fasteners.
- › Weight (lbs): 1.72

| Contents | Size (in) | Point Count | Overall Length (in) |
|----------|-------------|-------------|---------------------|
| J1191T-A | 1/4 x 5/16 | 12 | 4-1/2 |
| J1192T-A | 3/8 x 7/16 | 12 | 5-1/2 |
| J1193T-A | 1/2 x 9/16 | 12 | 6-7/8 |
| J1194-A | 5/8 x 11/16 | 12 | 8-1/8 |
| J1195-A | 3/4 x 7/8 | 12 | 9-1/4 |
| J25TR06C | Tool Roll | | |



RATCHETING

3 PIECE RATCHETING BOX WRENCH SET - 12 POINT

Product #: **J1190B**

- › Full polish finish provides corrosion resistance and easy to clean surfaces.
- › Built in retaining ring in each ratchet wheel adds speed and convenience for greater accessibility.
- › Shorter length for access to confined workspaces.
- › The wrench self-aligns with the fastener.
- › 12 point box end allows for fine indexing.
- › Fits 4, 6 and 12 point fasteners.
- › Weight (lbs): 1.10



| Contents | Size (in) | Point Count | Overall Length (in) |
|----------|-------------|-------------|---------------------|
| J1192T-A | 3/8 x 7/16 | 12 | 5-1/2 |
| J1193T-A | 1/2 x 9/16 | 12 | 6-7/8 |
| J1194-A | 5/8 x 11/16 | 12 | 8-1/8 |
| J25TR17C | Tool Roll | | |

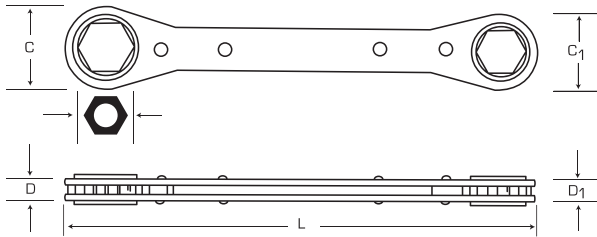

RATCHETING DOUBLE BOX WRENCHES - 6 POINT

- › Full polish finish provides corrosion resistance and easy to clean surfaces.
- › Shorter length for access to confined workspaces.
- › The wrench self-aligns with the fastener.
- › 6 point box end allows for large wrench to fastener contact area which helps prevent fastener rounding.



| Product # | Size (in) | Outside Head Width (in) (C) | Head Thickness (in) (D) | Outside Head Width (in) (C1) | Head Thickness (in) (D1) | Overall Length (in) | Weight (lbs) |
|-----------|------------|-----------------------------|-------------------------|------------------------------|--------------------------|---------------------|--------------|
| J1191-A | 1/4 x 5/16 | 19/32 | 3/8 | 43/64 | 3/8 | 4-1/2 | 0.12 |
| J1192-A | 3/8 x 7/16 | 3/4 | 1/2 | 7/8 | 1/2 | 5-1/2 | 0.18 |
| J1193-A | 1/2 x 9/16 | 1 | 1/2 | 1-1/8 | 1/2 | 6-7/8 | 0.29 |



METRIC RATCHETING DOUBLE BOX WRENCHES - 6 POINT

METRIC

- › Full polish finish provides corrosion resistance and easy to clean surfaces.
- › Shorter length for access to confined workspaces.
- › The wrench self-aligns with the fastener.
- › 6 point box end allows for large wrench to fastener contact area which helps prevent fastener rounding.



| Product # | Size (mm) | Outside Head Width (in) (C) | Head Thickness (in) (D) | Outside Head Width (in) (C1) | Head Thickness (in) (D1) | Overall Length (in) | Weight (lbs) |
|-----------|-----------|-----------------------------|-------------------------|------------------------------|--------------------------|---------------------|--------------|
| J1191M-A | 7 x 8 | 19/32 | 3/8 | 43/64 | 3/8 | 4-1/2 | 0.12 |
| J1192M-A | 9 x 10 | 25/32 | 3/8 | 7/8 | 3/8 | 5-1/2 | 0.17 |
| J1193MA-A | 11 x 13 | 1-1/64 | 1/2 | 1-5/32 | 1/2 | 6-7/8 | 0.31 |
| J1194MA-A | 12 x 14 | 1-1/64 | 1/2 | 1-5/32 | 1/2 | 6-7/8 | 0.39 |



RATCHETING DOUBLE BOX WRENCHES - 12 POINT

- › Full polish finish provides corrosion resistance and easy to clean surfaces.
- › Shorter length for access to confined workspaces.
- › The wrench self-aligns with the fastener.
- › 12 point box end allows for fine indexing.
- › Fits 4, 6 and 12 point fasteners.



| Product # | Size (in) | Outside Head Width (in) (C) | Head Thickness (in) (D) | Outside Head Width (in) (C1) | Head Thickness (in) (D1) | Overall Length (in) | Weight (lbs) |
|-----------|----------------|-----------------------------|-------------------------|------------------------------|--------------------------|---------------------|--------------|
| J1191T-A | 1/4 x 5/16 | 9/32 | 3/8 | 43/64 | 3/8 | 4-1/2 | 0.12 |
| J1192T-A | 3/8 x 7/16 | 3/4 | 3/8 | 7/8 | 3/8 | 5-1/2 | 0.17 |
| J1193T-A | 1/2 x 9/16 | 1 | 1/2 | 1-1/8 | 1/2 | 6-7/8 | 0.29 |
| J1194-A | 5/8 x 11/16 | 1-19/64 | 1/2 | 1-7/16 | 1/2 | 8-1/8 | 0.44 |
| J1195-A | 3/4 x 7/8 | 1-13/32 | 1/2 | 1-37/64 | 1/2 | 9-1/4 | 0.52 |
| J1196-A | 5/8 x 3/4 | 1-19/64 | 1/2 | 1-7/16 | 1/2 | 8-1/8 | 0.47 |
| J1197-A | 13/16 x 15/16 | 1-13/32 | 1/2 | 1-37/64 | 1/2 | 9-1/4 | 0.52 |
| J1198* | 1-1/4 x 1-1/16 | 1-29/32 | 9/16 | 2-1/4 | 9/16 | 15 | 1.38 |
| J1199* | 1-1/16 x 1-1/4 | 1-29/32 | 9/16 | 2-1/4 | 9/16 | 15 | 1.38 |

* Reversible



METRIC RATCHETING DOUBLE BOX WRENCHES - 12 POINT



- › Full polish finish provides corrosion resistance and easy to clean surfaces.
- › Shorter length for access to confined workspaces.
- › The wrench self-aligns with the fastener.
- › 12 point box end allows for fine indexing and fits 4, 6 and 12 point fasteners.
- › Fits 4, 6 and 12 point fasteners.



| Product # | Size (mm) | Outside Head Width (in) (C) | Head Thickness (in) (D) | Outside Head Width (in) (C1) | Head Thickness (in) (D1) | Overall Length (in) | Weight (lbs) |
|-----------------|-----------|-----------------------------|-------------------------|------------------------------|--------------------------|---------------------|--------------|
| J1195M-A | 15 x 17 | 1-19/64 | 1/2 | 1-7/16 | 1/2 | 8-7/64 | 0.48 |
| J1196M | 16 x 18 | 1-19/64 | 1/2 | 1-7/16 | 1/2 | 8-7/64 | 0.48 |
| J1197M | 19 x 21 | 1-13/32 | 1/2 | 1-37/64 | 1/2 | 9-15/64 | 0.55 |



REFRIGERATION WRENCHES

- › Full polish finish provides corrosion resistance and easy to clean surfaces.
- › Designed for servicing automotive, commercial, and residential air conditioners, refrigeration units and freezers.
- › Hex openings are used for packing gland fittings, mounting bolts, clutch bolts, tubing fittings, dust cap nuts and oil check plugs.
- › Square openings are used on male service valves, plug fittings, compressor valves and refrigerant charging tanks.
- › Reversing switch lever allows for easy changes in turning direction which helps improve speed.



| Product # | Size | Size | Overall Length (in) | Weight (lbs) |
|--------------|-------------------|----------------|---------------------|--------------|
| J1111 | 1/4 x 3/16 Square | 9/16 x 1/2 Hex | 7 | 0.35 |
| J1112 | 1/4 x 3/16 Square | 1/4 x 3/16 Hex | 5-1/2 | 0.25 |

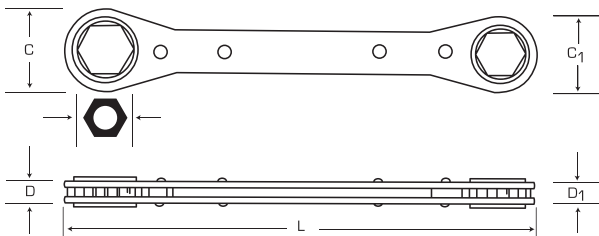

7 PIECE RATCHETING FLARE NUT WRENCH SET - 12 POINT

Product #: J3800A

- › Black oxide finish.
- › Non-reflective black oxide finish for use where non-plated products are required.
- › 12 Point flare nut box end allows for fine indexing, helping to improve speed and access.
- › Pivoting head allows user to place the wrench over the connected pipes to reach the fastener.
- › Weight (lbs): 1.93

| Contents | Size (in) | Point Count | Overall Length (in) |
|----------|-----------|-------------|---------------------|
| J3812 | 3/8 | 12 | 5-7/16 |
| J3814 | 7/16 | 12 | 5-7/16 |
| J3816 | 1/2 | 12 | 5-7/16 |
| J3818 | 9/16 | 12 | 7-1/4 |
| J3820 | 5/8 | 12 | 7-1/4 |
| J3822 | 11/16 | 12 | 7-1/4 |
| J3824 | 3/4 | 12 | 7-1/4 |
| J25TR03C | Tool Roll | | |



WRENCHES



RATCHETING FLARE NUT WRENCHES - 12 POINT

- › Black oxide finish.
- › Non-reflective black oxide finish for use where non-plated products are required.
- › 12 Point flare nut box end allows for fine indexing, helping to improve speed and access.
- › Pivoting head allows user to place the wrench over the connected pipes to reach the fastener.



| Product # | Size (in) | Outside Head Width (in) (C) | Head Thickness (in) (D) | Overall Length (in) | Weight (lbs) |
|--------------|-----------|-----------------------------|-------------------------|---------------------|--------------|
| J3812 | 3/8 | 1 | 9/32 | 5-7/16 | 0.17 |
| J3814 | 7/16 | 1 | 9/32 | 5-7/16 | 0.17 |
| J3816 | 1/2 | 1 | 9/32 | 5-7/16 | 0.17 |
| J3818 | 9/16 | 1-5/16 | 3/8 | 7-1/4 | 0.31 |
| J3820 | 5/8 | 1-5/16 | 3/8 | 7-1/4 | 0.31 |
| J3822 | 11/16 | 1-5/16 | 3/8 | 7-1/4 | 0.31 |
| J3824 | 3/4 | 1-5/16 | 3/8 | 7-1/4 | 0.31 |
| J3826 | 13/16 | 1-11/16 | 7/16 | 9-3/8 | 0.58 |
| J3828 | 7/8 | 1-11/16 | 7/16 | 9-3/8 | 0.58 |
| J3830 | 15/16 | 1-11/16 | 1/2 | 9-3/8 | 0.58 |
| J3832 | 1 | 1-11/16 | 1/2 | 9-3/8 | 0.58 |

RATCHETING

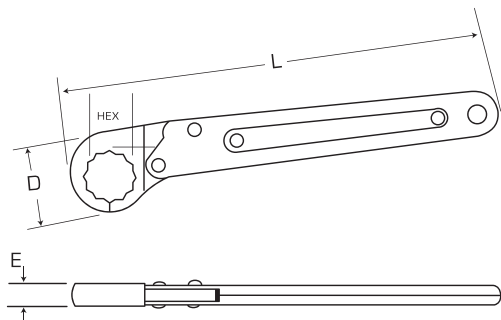

17 PIECE METRIC COMBINATION WRENCH SET - 12 POINT

METRIC

Product #: **J1200RM-T500**

- › Full polish finish provides corrosion resistance and easy to clean surfaces.
- › 12 point box end allows for fine indexing, helping to improve speed and access. Fits 4, 6 and 12 point fasteners.
- › Anti-Slip Design (ASD) open end. Metric sizes 9 mm and smaller do not have ASD feature.
- › Box ends incorporate the TorquePlus™ system.
- › Weight (lbs): 6.92



| Contents | Size (mm) | Point Count | Overall Length (in) |
|-------------|-----------|-------------|---------------------|
| J1207M-T500 | 7 | 12 | 5-5/32 |
| J1208M-T500 | 8 | 12 | 5-13/32 |
| J1209M-T500 | 9 | 12 | 5-21/32 |
| J1210M-T500 | 10 | 12 | 5-29/32 |
| J1211M-T500 | 11 | 12 | 6-29/32 |
| J1212M-T500 | 12 | 12 | 7-45/64 |
| J1213M-T500 | 13 | 12 | 7-29/32 |
| J1214M-T500 | 14 | 12 | 8-13/16 |
| J1215M-T500 | 15 | 12 | 9-5/32 |
| J1216M-T500 | 16 | 12 | 9-35/64 |
| J1217M-T500 | 17 | 12 | 10-9/32 |
| J1218M-T500 | 18 | 12 | 10-11/16 |
| J1219M-T500 | 19 | 12 | 11-1/32 |
| J1220M-T500 | 20 | 12 | 11-27/64 |
| J1221M-T500 | 21 | 12 | 11-13/16 |
| J1222M-T500 | 22 | 12 | 12-17/32 |
| J1224M-T500 | 24 | 12 | 13-5/16 |
| J25TR36C | Tool Roll | | |

ASME B107.100



15 PIECE COMBINATION ASD WRENCH SET - 12 POINT

Product #: **J1200F-T500**

- › Full polish finish provides corrosion resistance and easy to clean surfaces.
- › 12 point box end allows for fine indexing, helping to improve speed and access. Fits 4, 6, and 12 point fasteners.
- › Anti-Slip Design (ASD) open end. Fractional sizes 1 1/32" and smaller do not have the ASD feature.
- › Box ends incorporate the TorquePlus™ system.
- › Weight (lbs): 9.76



| Contents | Size (in) | Point Count | Overall Length (in) |
|------------|-----------|-------------|---------------------|
| J1210-T500 | 5/16 | 12 | 5-3/8 |
| J1212-T500 | 3/8 | 12 | 6 |
| J1214-T500 | 7/16 | 12 | 7 |
| J1216-T500 | 1/2 | 12 | 8 |
| J1218-T500 | 9/16 | 12 | 8-7/8 |
| J1220-T500 | 5/8 | 12 | 9-1/2 |
| J1222-T500 | 11/16 | 12 | 10-1/4 |
| J1224-T500 | 3/4 | 12 | 11 |
| J1226-T500 | 13/16 | 12 | 11-7/8 |
| J1228-T500 | 7/8 | 12 | 12-1/2 |
| J1230-T500 | 15/16 | 12 | 13-1/4 |
| J1232-T500 | 1 | 12 | 14 |
| J1234-T500 | 1-1/16 | 12 | 15-1/4 |
| J1236-T500 | 1-1/8 | 12 | 15-7/8 |
| J1240-T500 | 1-1/4 | 12 | 16-7/8 |
| J25TR34C | Tool Roll | | |

ASME B107.100



7 PIECE COMBINATION ASD WRENCH SET - 12 POINT

Product #: J1200H-T500

- › Full polish finish provides corrosion resistance and easy to clean surfaces.
- › 12 point box end allows for fine indexing, helping to improve speed and access. Fits 4, 6, and 12 point fasteners.
- › Anti-Slip Design (ASD) open end.
- › Box ends incorporate the TorquePlus™ system.
- › Weight (lbs): 2.02



| Contents | Size (in) | Point Count | Overall Length (in) |
|------------|-----------|-------------|---------------------|
| J1212-T500 | 3/8 | 12 | 6 |
| J1214-T500 | 7/16 | 12 | 7 |
| J1216-T500 | 1/2 | 12 | 8 |
| J1218-T500 | 9/16 | 12 | 8-7/8 |
| J1220-T500 | 5/8 | 12 | 9-1/2 |
| J1222-T500 | 11/16 | 12 | 10-1/4 |
| J1224-T500 | 3/4 | 12 | 11 |
| J25TR33C | Tool Roll | | |

ASME B107.100



FEATURES AND BENEFITS — ANTI-SLIP DESIGN (ASD)

The Anti-Slip Design consists of two features:

- › A notch to lock the fastener in place.
- › A curve for greater contact area against the fastener.

An ASD Wrench does not apply load to the corners of the fastener, so it helps to prevent rounding. Because of the greater surface contact, the wrench can also successfully apply greater torque without slipping.

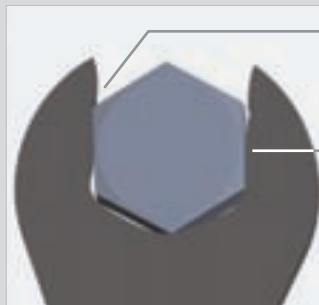

The groove locks the fastener in place.

The curved edge grips the flat of the bolt for a better grip and less rounding.

9 PIECE METRIC COMBINATION WRENCH SET - 12 POINT

METRIC

Product #: J1200HM-T500

- › Full polish finish provides corrosion resistance and easy to clean surfaces.
- › 12 point box end allows for fine indexing, helping to improve speed and access. Fits 4, 6 and 12 point fasteners.
- › Anti-Slip Design (ASD) open end. Metric sizes 9 mm and smaller do not have ASD feature.
- › Box ends incorporate the TorquePlus™ system.
- › Weight (lbs): 1.62



| Contents | Size (mm) | Point Count | Overall Length (in) |
|-------------|-----------|-------------|---------------------|
| J1207M-T500 | 7 | 12 | 5-5/32 |
| J1208M-T500 | 8 | 12 | 5-13/32 |
| J1209M-T500 | 9 | 12 | 5-21/32 |
| J1210M-T500 | 10 | 12 | 5-29/32 |
| J1211M-T500 | 11 | 12 | 6-29/32 |
| J1212M-T500 | 12 | 12 | 7-45/64 |
| J1213M-T500 | 13 | 12 | 7-29/32 |
| J1214M-T500 | 14 | 12 | 8-13/16 |
| J1215M-T500 | 15 | 12 | 9-5/32 |
| J25TR35C | Tool Roll | | |

ASME B107.100



FULL POLISH COMBINATION WRENCHES - 6 POINT

Delayed Availability

- › Full polish finish provides corrosion resistance and easy to clean surfaces.
- › 6 point box end allows for large wrench to fastener contact area which helps prevent rounding of the fastener.
- › Anti-Slip Design (ASD) open end. Fractional sizes 11/32" and smaller do not have the ASD feature.
- › Box ends incorporate the TorquePlus™ system.



| Product # | Size (in) | Throat Depth (in) (B) | Outside Head Width (in) (C) | Head Thickness (in) (D) | Outside Head Width (in) (C1) | Head Thickness (in) (D1) | Overall Length (in) | Weight (lbs) |
|-------------|-----------|-----------------------|-----------------------------|-------------------------|------------------------------|--------------------------|---------------------|--------------|
| J1208H-T500 | 1/4 | 19/64 | 39/64 | 5/32 | 27/64 | 15/64 | 4-59/64 | 0.04 |
| J1210H-T500 | 5/16 | 3/8 | 45/64 | 13/64 | 33/64 | 17/64 | 5-7/16 | 0.08 |
| J1211H-T500 | 11/32 | 13/32 | 25/32 | 21/32 | 17/32 | 7/32 | 5-43/64 | 0.08 |
| J1212H-T500 | 3/8 | 13/32 | 13/16 | 1/4 | 39/64 | 5/16 | 5-29/32 | 0.10 |
| J1214H-T500 | 7/16 | 17/32 | 15/16 | 17/64 | 43/64 | 21/64 | 6-29/32 | 0.14 |
| J1216H-T500 | 1/2 | 39/64 | 1-5/64 | 21/64 | 49/64 | 11/32 | 7-29/32 | 0.20 |
| J1218H-T500 | 9/16 | 11/16 | 1-3/16 | 11/32 | 27/32 | 23/64 | 8-13/16 | 0.27 |
| J1220H-T500 | 5/8 | 3/4 | 1-21/64 | 25/64 | 15/16 | 13/32 | 9-35/64 | 0.35 |
| J1222H-T500 | 11/16 | 13/16 | 1-29/64 | 27/64 | 1-1/64 | 7/16 | 10-19/64 | 0.38 |
| J1224H-T500 | 3/4 | 57/64 | 1-37/64 | 31/64 | 1-3/32 | 15/32 | 11-3/64 | 0.52 |
| J1226H-T500 | 13/16 | 31/32 | 1-11/16 | 33/64 | 1-11/64 | 1/2 | 11-13/16 | 0.54 |
| J1228H-T500 | 7/8 | 1-1/16 | 1-13/16 | 35/64 | 1-1/4 | 33/64 | 12-35/64 | 0.65 |
| J1230H-T500 | 15/16 | 1-1/8 | 1-29/32 | 39/64 | 1-27/64 | 37/64 | 13-5/16 | 0.74 |
| J1232H-T500 | 1 | 1-13/64 | 2-1/64 | 21/32 | 1-13/32 | 37/64 | 14-1/16 | 0.95 |
| J1234H-T500 | 1-1/16 | 1-9/32 | 2-9/64 | 45/64 | 1-31/64 | 39/64 | 15-1/4 | 1.13 |
| J1236H-T500 | 1-1/8 | 1-23/64 | 2-17/64 | 3/4 | 1-21/32 | 41/64 | 15-7/8 | 1.38 |
| J1238H-T500 | 1-3/16 | 1-23/64 | 2-25/64 | 3/4 | 1-21/32 | 21/32 | 15-7/8 | 1.54 |
| J1240H-T500 | 1-1/4 | 1-1/2 | 2-33/64 | 53/64 | 1-3/4 | 45/64 | 16-59/64 | 1.89 |

ASME B107.100

FULL POLISH METRIC COMBINATION WRENCHES - 6 POINT



Delayed Availability

- › Full polish finish provides corrosion resistance and easy to clean surfaces.
- › 6 point box end allows for large wrench to fastener contact area which helps prevent rounding of the fastener.
- › Anti-Slip Design (ASD) open end. Metric sizes 9 mm and smaller do not have ASD feature.
- › Box ends incorporate the TorquePlus™ system.



| Product # | Size (mm) | Throat Depth (in) (B) | Outside Head Width (in) (C) | Head Thickness (in) (D) | Outside Head Width (in) (C1) | Head Thickness (in) (D1) | Overall Length (in) | Weight (lbs) |
|--------------|-----------|-----------------------|-----------------------------|-------------------------|------------------------------|--------------------------|---------------------|--------------|
| J1206MH-T500 | 6 | 19/64 | 35/64 | 5/32 | 25/64 | 5/32 | 4-59/64 | 0.04 |
| J1207MH-T500 | 7 | 5/16 | 19/32 | 3/16 | 13/32 | 15/64 | 5-11/64 | 0.04 |
| J1208MH-T500 | 8 | 25/64 | 11/16 | 13/64 | 1/2 | 17/64 | 5-7/16 | 0.07 |
| J1209MH-T500 | 9 | 13/32 | 3/4 | 7/32 | 35/64 | 17/64 | 5-43/64 | 0.08 |
| J1210MH-T500 | 10 | 31/64 | 7/8 | 1/4 | 21/32 | 5/16 | 5-29/32 | 0.13 |
| J1211MH-T500 | 11 | 33/64 | 59/64 | 17/64 | 11/16 | 21/64 | 6-29/32 | 0.14 |
| J1212MH-T500 | 12 | 9/16 | 1 | 19/64 | 47/64 | 11/32 | 7-23/32 | 0.17 |
| J1213MH-T500 | 13 | 39/64 | 1-1/32 | 21/64 | 25/32 | 11/32 | 7-29/32 | 0.18 |
| J1214MH-T500 | 14 | 11/16 | 1-3/16 | 11/32 | 55/64 | 23/64 | 8-13/16 | 0.22 |
| J1215MH-T500 | 15 | 3/4 | 1-1/4 | 3/8 | 7/8 | 23/64 | 9-9/64 | 0.25 |
| J1216MH-T500 | 16 | 3/4 | 1-21/64 | 25/64 | 15/16 | 13/32 | 9-35/64 | 0.26 |
| J1217MH-T500 | 17 | 53/64 | 1-25/64 | 27/64 | 1-1/32 | 7/16 | 10-19/64 | 0.38 |
| J1218MH-T500 | 18 | 55/64 | 1-33/64 | 29/64 | 1-1/16 | 29/64 | 10-11/16 | 0.41 |
| J1219MH-T500 | 19 | 29/32 | 1-37/64 | 31/64 | 1-7/64 | 15/32 | 11-3/64 | 0.46 |

ASME B107.100



FULL POLISH COMBINATION WRENCHES - 12 POINT

- › Full polish finish provides corrosion resistance and easy to clean surfaces.
- › 12 point box end allows for fine indexing, helping to improve speed and access. Fits 4, 6, and 12 point fasteners.
- › Anti-Slip Design (ASD) open end.
- › Fractional sizes 11/32" and smaller do not have the ASD feature.
- › Box ends incorporate the TorquePlus™ system.



| Product # | Size (in) | Throat | Outside Head | Head | Outside Head | Head | Overall Length (in) | Weight (lbs) |
|------------|-----------|----------------|----------------|--------------------|-----------------|---------------------|---------------------|--------------|
| | | Depth (in) (B) | Width (in) (C) | Thickness (in) (D) | Width (in) (C1) | Thickness (in) (D1) | | |
| J1208-T500 | 1/4 | 19/64 | 39/64 | 3/16 | 27/64 | 15/64 | 4-7/8 | 0.04 |
| J1209-T500 | 9/32 | 23/64 | 41/64 | 3/16 | 29/64 | 7/32 | 5-5/32 | 0.06 |
| J1210-T500 | 5/16 | 3/8 | 45/64 | 3/16 | 33/64 | 17/64 | 5-3/8 | 0.08 |
| J1211-T500 | 11/32 | 13/32 | 25/32 | 3/16 | 17/32 | 7/32 | 5-5/8 | 0.08 |
| J1212-T500 | 3/8 | 13/32 | 13/16 | 3/16 | 39/64 | 5/16 | 6 | 0.10 |
| J1214-T500 | 7/16 | 17/32 | 15/16 | 15/64 | 43/64 | 21/64 | 7 | 0.14 |
| J1216-T500 | 1/2 | 39/64 | 1-5/64 | 1/4 | 49/64 | 11/32 | 8 | 0.20 |
| J1218-T500 | 9/16 | 11/16 | 1-3/16 | 9/32 | 27/32 | 23/64 | 8-7/8 | 0.27 |
| J1220-T500 | 5/8 | 3/4 | 1-21/64 | 19/64 | 15/16 | 13/32 | 9-1/2 | 0.35 |
| J1222-T500 | 11/16 | 13/16 | 1-29/64 | 5/16 | 1-1/64 | 7/16 | 10-1/4 | 0.38 |
| J1224-T500 | 3/4 | 57/64 | 1-37/64 | 11/32 | 1-3/32 | 15/32 | 11 | 0.52 |
| J1226-T500 | 13/16 | 31/32 | 1-11/16 | 23/64 | 1-11/64 | 1/2 | 11-7/8 | 0.54 |
| J1228-T500 | 7/8 | 1-1/16 | 1-13/16 | 3/8 | 1-1/4 | 33/64 | 12-1/2 | 0.65 |
| J1230-T500 | 15/16 | 1-1/8 | 1-29/32 | 13/32 | 1-27/64 | 37/64 | 13-1/4 | 0.74 |
| J1232-T500 | 1 | 1-13/64 | 2-1/64 | 13/32 | 1-13/32 | 37/64 | 14 | 0.95 |
| J1234-T500 | 1-1/16 | 1-9/32 | 2-9/64 | 29/64 | 1-31/64 | 39/64 | 15-1/4 | 1.13 |
| J1236-T500 | 1-1/8 | 1-23/64 | 2-17/64 | 15/32 | 1-21/32 | 41/64 | 15-7/8 | 1.38 |
| J1240-T500 | 1-1/4 | 1-1/2 | 2-33/64 | 33/64 | 1-3/4 | 45/64 | 16-7/8 | 1.89 |



ASME B107.100

FULL POLISH METRIC COMBINATION WRENCHES - 12 POINT

METRIC

- › Full polish finish provides corrosion resistance and easy to clean surfaces.
- › 12 point box end allows for fine indexing, helping to improve speed and access. Fits 4, 6 and 12 point fasteners.
- › Anti-Slip Design (ASD) open end.
- › Metric sizes 9 mm and smaller do not have ASD feature.
- › Box ends incorporate the TorquePlus™ system.



| Product # | Size (mm) | Throat | Outside Head | Head | Outside Head | Head | Overall Length (in) | Weight (lbs) |
|-------------|-----------|----------------|----------------|--------------------|-----------------|---------------------|---------------------|--------------|
| | | Depth (in) (B) | Width (in) (C) | Thickness (in) (D) | Width (in) (C1) | Thickness (in) (D1) | | |
| J1207M-T500 | 7 | 5/16 | 19/32 | 11/64 | 13/32 | 15/64 | 5-5/32 | 0.04 |
| J1208M-T500 | 8 | 25/64 | 11/16 | 3/16 | 1/2 | 17/64 | 5-13/32 | 0.07 |
| J1209M-T500 | 9 | 13/32 | 3/4 | 3/16 | 35/64 | 17/64 | 5-21/32 | 0.08 |
| J1210M-T500 | 10 | 31/64 | 7/8 | 7/32 | 21/32 | 5/16 | 5-29/32 | 0.13 |
| J1211M-T500 | 11 | 33/64 | 59/64 | 15/64 | 11/16 | 21/64 | 6-29/32 | 0.14 |
| J1212M-T500 | 12 | 9/16 | 1 | 1/4 | 47/64 | 11/32 | 7-45/64 | 0.17 |
| J1213M-T500 | 13 | 39/64 | 1-1/32 | 1/4 | 25/32 | 11/32 | 7-29/32 | 0.18 |
| J1214M-T500 | 14 | 11/16 | 1-3/16 | 9/32 | 55/64 | 23/64 | 8-13/16 | 0.22 |
| J1215M-T500 | 15 | 3/4 | 1-1/4 | 19/64 | 7/8 | 23/64 | 9-5/32 | 0.25 |
| J1216M-T500 | 16 | 3/4 | 1-21/64 | 5/16 | 15/16 | 13/32 | 9-35/64 | 0.26 |
| J1217M-T500 | 17 | 53/64 | 1-25/64 | 21/64 | 1-1/32 | 7/16 | 10-9/32 | 0.38 |
| J1218M-T500 | 18 | 55/64 | 1-33/64 | 11/32 | 1-1/16 | 29/64 | 10-11/16 | 0.41 |
| J1219M-T500 | 19 | 29/32 | 1-37/64 | 11/32 | 1-7/64 | 15/32 | 11-1/32 | 0.46 |
| J1220M-T500 | 20 | 63/64 | 1-11/16 | 23/64 | 1-3/16 | 31/64 | 11-27/64 | 0.55 |
| J1221M-T500 | 21 | 63/64 | 1-11/16 | 23/64 | 1-3/16 | 31/64 | 11-13/16 | 0.54 |
| J1222M-T500 | 22 | 1-3/64 | 1-25/32 | 3/8 | 1-17/64 | 1/2 | 12-17/32 | 0.62 |
| J1224M-T500 | 24 | 1-1/8 | 1-57/64 | 13/32 | 1-11/32 | 35/64 | 13-5/16 | 0.77 |



ASME B107.100

FULL POLISH COMBINATION WRENCHES - SPLINE

- › Proto® Spline Tools are designed to service high tensile strength fasteners used widely on military and commercial aircraft and in heavy machinery applications where vibration is prevalent. They are also used in automotive and industrial areas where high performance torque needs to be achieved.
- › Spline fasteners help tighten high strength bolts to high torque loads.
- › They help lower the force required to turn standard fasteners by allowing the torque load to be moved away from the corners, helping prevent fastener rounding. They also turn fasteners with damaged corners.
- › Spline helps reduce foreign object debris (FOD) by having a precise fit between the fastening tool and its fastener.
- › Full polish finish provides corrosion resistance and an easy to clean surface.
- › Anti-Slip Design (ASD) open end.
- › Fractional sizes 11/32" and smaller do not have the ASD feature.



| Product # | Size (in) | Throat Depth (in) (B) | Outside Head Width (in) (C) | Head Thickness (in) (D) | Outside Head Width (in) (C1) | Head Thickness (in) (D1) | Overall Length (in) | Weight (lbs) |
|-----------|-----------|-----------------------|-----------------------------|-------------------------|------------------------------|--------------------------|---------------------|--------------|
| J1208SPL | 1/4 | 17/64 | 35/64 | 5/32 | 25/64 | 11/64 | 4-29/32 | 0.06 |
| J1209SPL | 9/32 | 19/64 | 39/64 | 11/64 | 7/16 | 11/64 | 5-5/32 | 0.07 |
| J1210SPL | 5/16 | 21/64 | 11/16 | 11/64 | 31/64 | 3/16 | 5-27/64 | 0.08 |
| J1211SPL | 11/32 | 23/64 | 25/32 | 3/16 | 35/64 | 7/32 | 5-21/32 | 0.09 |
| J1212SPL | 3/8 | 13/32 | 27/32 | 13/64 | 37/64 | 15/64 | 5-59/62 | 0.10 |
| J1214SPL | 7/16 | 15/32 | 15/16 | 7/32 | 43/64 | 17/64 | 6-29/32 | 0.14 |
| J1216SPL | 1/2 | 17/32 | 1-5/64 | 1/4 | 47/64 | 5/16 | 7-29/32 | 0.20 |
| J1218SPL | 9/16 | 19/32 | 1-13/64 | 9/32 | 13/16 | 11/32 | 8-53/64 | 0.26 |
| J1220SPL | 5/8 | 43/64 | 1-21/64 | 19/64 | 57/64 | 3/8 | 9-35/64 | 0.34 |
| J1222SPL | 11/16 | 47/64 | 1-7/16 | 5/16 | 63/64 | 13/32 | 10-19/64 | 0.42 |
| J1224SPL | 3/4 | 51/64 | 1-37/64 | 11/32 | 1-5/64 | 15/32 | 11-3/64 | 0.50 |
| J1226SPL | 13/16 | 55/64 | 1-23/32 | 23/64 | 1-3/16 | 33/64 | 11-53/64 | 0.59 |
| J1228SPL | 7/8 | 15/16 | 1-27/32 | 3/8 | 1-1/4 | 17/32 | 12-17/32 | 0.73 |
| J1230SPL | 15/16 | 1 | 1-31/32 | 25/64 | 1-23/64 | 37/64 | 13-5/16 | 0.90 |
| J1232SPL | 1 | 1-1/16 | 2-3/32 | 27/64 | 1-29/64 | 37/64 | 14-1/16 | 1.10 |

FEATURES AND BENEFITS — A SPLINE END FITS MANY TYPES OF FASTENERS

Spline End Wrenches are versatile tools that handle several types of fasteners better than conventional wrenches.

- › One Spline End wrench can replace many because the innovative spline end can grab and turn several types of fasteners.
- › The contact points for spline end sockets are always away from the corners of the fastener. This design, by its nature, reduces the problem of rounding.
- › The same grip also turns previously-rounded fasteners better, because the splines grip the head along the flat edge.

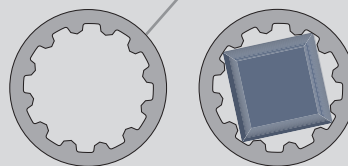

One wrench replaces many wrenches.

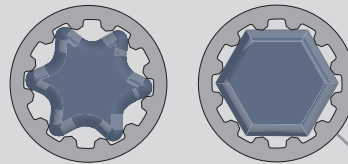

A better grip on rounded fasteners.

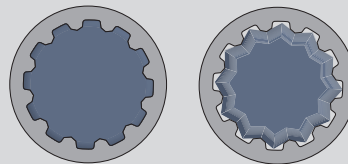

31 PIECE COMBINATION ASD WRENCH SET - 12 POINT

Product #: **J1200-90ASD**

| Contents | Size (in) | Point Count | Overall Length (in) |
|----------|-----------|-------------|---------------------|
| J1210A | 5/16 | 12 | 5-3/8 |
| J1212ASD | 3/8 | 12 | 6 |
| J1214ASD | 7/16 | 12 | 7 |
| J1216ASD | 1/2 | 12 | 8 |
| J1218ASD | 9/16 | 12 | 8-7/8 |
| J1220ASD | 5/8 | 12 | 9-1/2 |
| J1222ASD | 11/16 | 12 | 10-1/4 |
| J1224ASD | 3/4 | 12 | 11 |
| J1226ASD | 13/16 | 12 | 11-7/8 |
| J1228ASD | 7/8 | 12 | 12-1/2 |
| J1230ASD | 15/16 | 12 | 13-1/4 |
| J1232ASD | 1 | 12 | 14 |
| J1234ASD | 1-1/16 | 12 | 15-1/4 |
| J1236ASD | 1-1/8 | 12 | 15-7/8 |
| J1240ASD | 1-1/4 | 12 | 16-7/8 |
| J1242 | 1-5/16 | 12 | 17-5/8 |
| J1244 | 1-3/8 | 12 | 18-1/2 |
| J1246 | 1-7/16 | 12 | 19-3/8 |
| J1248 | 1-1/2 | 12 | 20-1/4 |
| J1252 | 1-5/8 | 12 | 23 |
| J1254 | 1-11/16 | 12 | 23 |
| J1256 | 1-3/4 | 12 | 25 |
| J1258 | 1-13/16 | 12 | 25 |
| J1260 | 1-7/8 | 12 | 28 |
| J1264 | 2 | 12 | 28 |
| J1266 | 2-1/16 | 12 | 29-1/2 |
| J1268 | 2-1/8 | 12 | 29-1/2 |
| J1270 | 2-3/16 | 12 | 29-1/2 |
| J1272 | 2-1/4 | 12 | 29-1/2 |
| J1276 | 2-3/8 | 12 | 31-1/2 |
| J1280 | 2-1/2 | 12 | 31-1/2 |
| J25TR34C | Tool Roll | | |

 ASME B107.100

- › Satin finish provides corrosion resistance and a slip-resistant grip.
- › 12 point box end allows for fine indexing, helping to improve speed and access. Fits 4, 6 and 12 point fasteners.
- › Anti-Slip Design (ASD) open end. Fractional sizes 11/32" and smaller and 1-15/16" and larger do not have the ASD feature.
- › Box ends incorporate the TorquePlus™ system.
- › Weight (lbs): 124



FEATURES AND BENEFITS — ANTI-SLIP DESIGN (ASD)

The Anti-Slip Design consists of two features:

- › A notch to lock the fastener in place.
- › A curve for greater contact area against the fastener.

An ASD Wrench does not apply load to the corners of the fastener, so it helps to prevent rounding. Because of the greater surface contact, the wrench can also successfully apply greater torque without slipping.

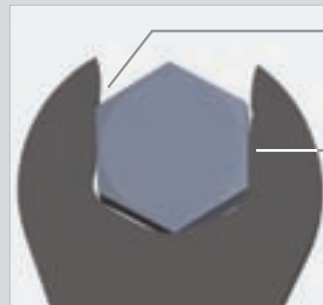

The groove locks the fastener in place.

The curved edge grips the flat of the bolt for a better grip and less rounding.

26 PIECE COMBINATION ASD WRENCH SET - 12 POINT

Product #: **J1200-80ASD**

| Contents | Size (in) | Point Count | Overall Length (in) |
|----------|-----------|-------------|---------------------|
| J1208A | 1/4 | 12 | 4-7/8 |
| J1210A | 5/16 | 12 | 5-3/8 |
| J1212ASD | 3/8 | 12 | 6 |
| J1214ASD | 7/16 | 12 | 7 |
| J1216ASD | 1/2 | 12 | 8 |
| J1218ASD | 9/16 | 12 | 8-7/8 |
| J1220ASD | 5/8 | 12 | 9-1/2 |
| J1222ASD | 11/16 | 12 | 10-1/4 |
| J1224ASD | 3/4 | 12 | 11 |
| J1226ASD | 13/16 | 12 | 11-7/8 |
| J1228ASD | 7/8 | 12 | 12-1/2 |
| J1230ASD | 15/16 | 12 | 13-1/4 |
| J1232ASD | 1 | 12 | 14 |
| J1234ASD | 1-1/16 | 12 | 15-1/4 |
| J1236ASD | 1-1/8 | 12 | 15-7/8 |
| J1240ASD | 1-1/4 | 12 | 16-7/8 |
| J1242 | 1-5/16 | 12 | 17-5/8 |
| J1244 | 1-3/8 | 12 | 18-1/2 |
| J1246 | 1-7/16 | 12 | 19-3/8 |
| J1248 | 1-1/2 | 12 | 20-1/4 |
| J1252 | 1-5/8 | 12 | 23 |
| J1254 | 1-11/16 | 12 | 23 |
| J1256 | 1-3/4 | 12 | 25 |
| J1258 | 1-13/16 | 12 | 25 |
| J1260 | 1-7/8 | 12 | 28 |
| J1264 | 2 | 12 | 28 |



ASME B107.100

- › Satin finish provides corrosion resistance and a slip-resistant grip.
- › 12 point box end allows for fine indexing, helping to improve speed and access. Fits 4, 6 and 12 point fasteners.
- › Anti-Slip Design (ASD) open end. Fractional sizes 11/32" and smaller and sizes 1-5/16" and larger do not have the ASD feature.
- › Box ends incorporate the TorquePlus™ system.
- › Weight (lbs): 57.42



PRODUCT FEATURES AND BENEFITS —



- › High performance drive configuration allows for quick and easy socket engagement to the fastener flats, not the corners.
- › Employs a radius-corner design, shifting contact area and stress away from the fastener corners and distributing contact stresses over a large area of the socket, minimizing slippage.
- › The internal design minimizes fastener rounding, helps to extend fastener life, and allows the user to more easily turn worn, rounded, or rusted fasteners.

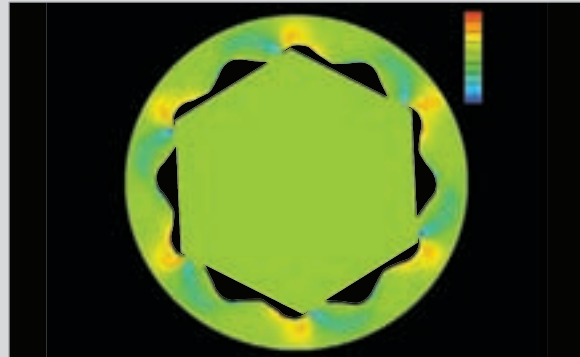

18 PIECE METRIC COMBINATION ASD WRENCH SET - 12 POINT METRIC

Product #: J1200R-MASD

| Contents | Size (mm) | Point Count | Overall Length (in) |
|-----------|-----------|-------------|---------------------|
| J1207MA | 7 | 12 | 5-5/32 |
| J1208MA | 8 | 12 | 5-13/32 |
| J1209MA | 9 | 12 | 5-21/32 |
| J1210MASD | 10 | 12 | 5-29/32 |
| J1211MASD | 11 | 12 | 6-29/32 |
| J1212MASD | 12 | 12 | 7-45/64 |
| J1213MASD | 13 | 12 | 7-29/32 |
| J1214MASD | 14 | 12 | 8-13/16 |
| J1215MASD | 15 | 12 | 9-5/32 |
| J1216MASD | 16 | 12 | 9-35/64 |
| J1217MASD | 17 | 12 | 10-9/32 |
| J1218MASD | 18 | 12 | 10-11/16 |
| J1219MASD | 19 | 12 | 11-1/32 |
| J1220MASD | 20 | 12 | 11-27/64 |
| J1221MASD | 21 | 12 | 11-13/16 |
| J1222MASD | 22 | 12 | 12-17/32 |
| J1223MASD | 23 | 12 | 12-59/64 |
| J1224MASD | 24 | 12 | 13-5/16 |
| J25TR42C | Tool Roll | | |

 ASME B107.100

- › Satin finish provides corrosion resistance and a slip-resistant grip.
- › 12 point box end allows for fine indexing, helping to improve speed and access. Fits 4, 6 and 12 point fasteners.
- › Anti-Slip Design (ASD) open end. Metric sizes 9 mm and smaller do not have ASD feature.
- › Box ends incorporate the TorquePlus™ system.
- › Weight (lbs): 8.1



16 PIECE COMBINATION WRENCH SET - 12 POINT

Product #: J1200F-HD

| Contents | Size (in) | Point Count | Overall Length (in) |
|----------|-----------|-------------|---------------------|
| J1242 | 1-5/16 | 12 | 17-5/8 |
| J1244 | 1-3/8 | 12 | 18-1/2 |
| J1246 | 1-7/16 | 12 | 19-3/8 |
| J1248 | 1-1/2 | 12 | 20-1/4 |
| J1252 | 1-5/8 | 12 | 23 |
| J1254 | 1-11/16 | 12 | 23 |
| J1256 | 1-3/4 | 12 | 25 |
| J1258 | 1-13/16 | 12 | 25 |
| J1260 | 1-7/8 | 12 | 28 |
| J1264 | 2 | 12 | 28 |
| J1266 | 2-1/16 | 12 | 29-1/2 |
| J1268 | 2-1/8 | 12 | 29-1/2 |
| J1270 | 2-3/16 | 12 | 29-1/2 |
| J1272 | 2-1/4 | 12 | 29-1/2 |
| J1276 | 2-3/8 | 12 | 31-1/2 |
| J1280 | 2-1/2 | 12 | 31-1/2 |

 ASME B107.100

- › Satin finish provides corrosion resistance and a slip-resistant grip.
- › 12 point box end allows for fine indexing, helping to improve speed and access. Fits 4, 6 and 12 point fasteners.
- › 15° angled offset box end helps keep shank clear of obstructions.
- › The box end is countersunk for easy application to the fastener.
- › Box ends incorporate the TorquePlus™ system.
- › Weight (lbs): 113.5



15 PIECE COMBINATION ASD WRENCH SET - 12 POINT

Product #: **J1200FASD**

| Contents | Size (in) | Point Count | Overall Length (in) |
|----------|-----------|-------------|---------------------|
| J1210A | 5/16 | 12 | 5-3/8 |
| J1212ASD | 3/8 | 12 | 6 |
| J1214ASD | 7/16 | 12 | 7 |
| J1216ASD | 1/2 | 12 | 8 |
| J1218ASD | 9/16 | 12 | 8-7/8 |
| J1220ASD | 5/8 | 12 | 9-1/2 |
| J1222ASD | 11/16 | 12 | 10-1/4 |
| J1224ASD | 3/4 | 12 | 11 |
| J1226ASD | 13/16 | 12 | 11-7/8 |
| J1228ASD | 7/8 | 12 | 12-1/2 |
| J1230ASD | 15/16 | 12 | 13-1/4 |
| J1232ASD | 1 | 12 | 14 |
| J1234ASD | 1-1/16 | 12 | 15-1/4 |
| J1236ASD | 1-1/8 | 12 | 15-7/8 |
| J1240ASD | 1-1/4 | 12 | 16-7/8 |
| J25TR34C | Tool Roll | | |

 ASME B107.100

- › Satin finish provides corrosion resistance and a slip-resistant grip.
- › 12 point box end allows for fine indexing, helping to improve speed and access. Fits 4, 6 and 12 point fasteners.
- › Anti-Slip Design (ASD) open end. Fractional sizes 11/32" and smaller do not have the ASD feature.
- › Box ends incorporate the TorquePlus™ system.
- › Weight (lbs): 9.75



15 PIECE METRIC COMBINATION ASD WRENCH SET - 12 POINT **METRIC**

Product #: **J1200F-MASD**

| Contents | Size (mm) | Point Count | Overall Length (in) |
|-----------|-----------|-------------|---------------------|
| J1207MA | 7 | 12 | 5-5/32 |
| J1208MA | 8 | 12 | 5-13/32 |
| J1209MA | 9 | 12 | 5-21/32 |
| J1210MASD | 10 | 12 | 5-29/32 |
| J1211MASD | 11 | 12 | 6-29/32 |
| J1212MASD | 12 | 12 | 7-45/64 |
| J1213MASD | 13 | 12 | 7-29/32 |
| J1214MASD | 14 | 12 | 8-13/16 |
| J1215MASD | 15 | 12 | 9-5/32 |
| J1216MASD | 16 | 12 | 9-35/64 |
| J1217MASD | 17 | 12 | 10-9/32 |
| J1218MASD | 18 | 12 | 10-11/16 |
| J1219MASD | 19 | 12 | 11-1/32 |
| J1220MASD | 20 | 12 | 11-27/64 |
| J1221MASD | 21 | 12 | 11-13/16 |
| J25TR41C | Tool Roll | | |

 ASME B107.100

- › Satin finish provides corrosion resistance and a slip-resistant grip.
- › 12 point box end allows for fine indexing, helping to improve speed and access. Fits 4, 6 and 12 point fasteners.
- › Anti-Slip Design (ASD) open end. Metric sizes 9 mm and smaller do not have ASD feature.
- › Box ends incorporate the TorquePlus™ system.
- › Weight (lbs): 4.25



15 PIECE METRIC COMBINATION ASD WRENCH SET - 12 POINT METRIC

Product #: J1200P-MASD

| Contents | Size (mm) | Point Count | Overall Length (in) |
|-----------|-----------|-------------|---------------------|
| J1207MA | 7 | 12 | 5-5/32 |
| J1208MA | 8 | 12 | 5-13/32 |
| J1210MASD | 10 | 12 | 5-29/32 |
| J1212MASD | 12 | 12 | 7-45/64 |
| J1214MASD | 14 | 12 | 8-13/16 |
| J1216MASD | 16 | 12 | 9-35/64 |
| J1218MASD | 18 | 12 | 10-11/16 |
| J1220MASD | 20 | 12 | 11-27/64 |
| J1222MASD | 22 | 12 | 12-17/32 |
| J1224MASD | 24 | 12 | 13-5/16 |
| J1226MASD | 26 | 12 | 14-41/64 |
| J1228MASD | 28 | 12 | 15-35/64 |
| J1229MASD | 29 | 12 | 15-55/64 |
| J1230MASD | 30 | 12 | 15-55/64 |
| J1232MASD | 32 | 12 | 16-59/64 |
| J25TR41C | Tool Roll | | |

 ASME B107.100

- › Satin finish provides corrosion resistance and a slip-resistant grip.
- › 12 point box end allows for fine indexing, helping to improve speed and access. Fits 4, 6 and 12 point fasteners.
- › Anti-Slip Design (ASD) open end. Metric sizes 9 mm and smaller do not have ASD feature.
- › Box ends incorporate the TorquePlus™ system.
- › Weight (lbs): 4.25



10 PIECE COMBINATION ASD WRENCH SET - 12 POINT

Product #: J1200GASD

| Contents | Size (in) | Point Count | Overall Length (in) |
|----------|-----------|-------------|---------------------|
| J1214ASD | 7/16 | 12 | 7 |
| J1216ASD | 1/2 | 12 | 8 |
| J1218ASD | 9/16 | 12 | 8-7/8 |
| J1220ASD | 5/8 | 12 | 9-1/2 |
| J1222ASD | 11/16 | 12 | 10-1/4 |
| J1224ASD | 3/4 | 12 | 11 |
| J1226ASD | 13/16 | 12 | 11-7/8 |
| J1228ASD | 7/8 | 12 | 12-1/2 |
| J1230ASD | 15/16 | 12 | 13-1/4 |
| J1232ASD | 1 | 12 | 14 |
| J25TR05C | Tool Roll | | |

 ASME B107.100

- › Satin finish provides corrosion resistance and a slip-resistant grip.
- › 12 point box end allows for fine indexing, helping to improve speed and access. Fits 4, 6 and 12 point fasteners.
- › Anti-Slip Design (ASD) open end.
- › Box ends incorporate the TorquePlus™ system.
- › Weight (lbs): 4.88



10 PIECE METRIC COMBINATION ASD WRENCH SET - 12 POINT METRIC

Product #: J1200K-MASD

| Contents | Size (mm) | Point Count | Overall Length (in) |
|-----------|-----------|-------------|---------------------|
| J1210MASD | 10 | 12 | 5-29/32 |
| J1211MASD | 11 | 12 | 6-29/32 |
| J1212MASD | 12 | 12 | 7-45/64 |
| J1213MASD | 13 | 12 | 7-29/32 |
| J1214MASD | 14 | 12 | 8-13/16 |
| J1215MASD | 15 | 12 | 9-5/32 |
| J1216MASD | 16 | 12 | 9-35/64 |
| J1217MASD | 17 | 12 | 10-9/32 |
| J1218MASD | 18 | 12 | 10-11/16 |
| J1219MASD | 19 | 12 | 11-1/32 |
| J25TR39C | Tool Roll | | |

 ASME B107.100

- › Satin finish provides corrosion resistance and a slip-resistant grip.
- › 12 point box end allows for fine indexing, helping to improve speed and access. Fits 4, 6 and 12 point fasteners.
- › Anti-Slip Design (ASD) open end.
- › Box ends incorporate the TorquePlus™ system.
- › Weight (lbs): 2.71



10 PIECE COMBINATION ASD WRENCH SET - 6 POINT

Product #: **J1200GHASD**

| Contents | Size (in) | Point Count | Overall Length (in) |
|-----------|-----------|-------------|---------------------|
| J1214HASD | 7/16 | 6 | 7 |
| J1216HASD | 1/2 | 6 | 8 |
| J1218HASD | 9/16 | 6 | 8-7/8 |
| J1220HASD | 5/8 | 6 | 9-1/2 |
| J1222HASD | 11/16 | 6 | 10-1/4 |
| J1224HASD | 3/4 | 6 | 11 |
| J1226HASD | 13/16 | 6 | 11-7/8 |
| J1228HASD | 7/8 | 6 | 12-1/2 |
| J1230HASD | 15/16 | 6 | 13-1/4 |
| J1232HASD | 1 | 6 | 14 |
| J25TR05C | Tool Roll | | |

 ASME B107.100

- › Satin finish provides corrosion resistance and a slip-resistant grip.
- › 6 point box end allows for large wrench to fastener contact area which helps prevent rounding of the fastener.
- › Anti-Slip Design (ASD) open end.
- › Box ends incorporate the TorquePlus™ system.
- › Weight (lbs): 4.88



10 PIECE METRIC COMBINATION ASD WRENCH SET - 6 POINT METRIC

Product #: **J1200MHASD**

| Contents | Size (mm) | Point Count | Overall Length (in) |
|------------|-----------|-------------|---------------------|
| J1210MHASD | 10 | 6 | 5-29/32 |
| J1211MHASD | 11 | 6 | 6-29/32 |
| J1212MHASD | 12 | 6 | 7-45/64 |
| J1213MHASD | 13 | 6 | 7-29/32 |
| J1214MHASD | 14 | 6 | 8-13/16 |
| J1215MHASD | 15 | 6 | 9-5/32 |
| J1216MHASD | 16 | 6 | 9-35/64 |
| J1217MHASD | 17 | 6 | 10-9/32 |
| J1218MHASD | 18 | 6 | 10-11/16 |
| J1219MHASD | 19 | 6 | 11-1/32 |
| J25TR39C | Tool Roll | | |

 ASME B107.100

- › Satin finish provides corrosion resistance and a slip-resistant grip.
- › 6 point box end allows for large wrench to fastener contact area which helps prevent rounding of the fastener.
- › Anti-Slip Design (ASD) open end.
- › Box ends incorporate the TorquePlus™ system.
- › Weight (lbs): 3.46



9 PIECE METRIC COMBINATION ASD WRENCH SET - 12 POINT METRIC

Product #: **J1200H-MASD**

| Contents | Size (mm) | Point Count | Overall Length (in) |
|-----------|-----------|-------------|---------------------|
| J1207MA | 7 | 12 | 5-5/32 |
| J1208MA | 8 | 12 | 5-13/32 |
| J1209MA | 9 | 12 | 5-21/32 |
| J1210MASD | 10 | 12 | 5-29/32 |
| J1211MASD | 11 | 12 | 6-29/32 |
| J1212MASD | 12 | 12 | 7-45/64 |
| J1213MASD | 13 | 12 | 7-29/32 |
| J1214MASD | 14 | 12 | 8-13/16 |
| J1215MASD | 15 | 12 | 9-5/32 |
| J25TR38C | Tool Roll | | |

 ASME B107.100

- › Satin finish provides corrosion resistance and a slip-resistant grip.
- › 12 point box end allows for fine indexing, helping to improve speed and access. Fits 4, 6 and 12 point fasteners.
- › Anti-Slip Design (ASD) open end. Metric sizes 9 mm and smaller do not have ASD feature.
- › Box ends incorporate the TorquePlus™ system.
- › Weight (lbs): 1.43



8 PIECE SHORT COMBINATION WRENCH SET - 6 POINT

Product #: **J1200EF**

| Contents | Size (in) | Point Count | Overall Length (in) |
|----------|-----------|-------------|---------------------|
| J1204EF | 1/8 | 6 | 2-49/64 |
| J1205EF | 5/32 | 6 | 2-57/64 |
| J1206EF | 3/16 | 6 | 3-1/4 |
| J1208EF | 1/4 | 6 | 3-17/64 |
| J1209EF | 9/32 | 6 | 3-7/16 |
| J1210EF | 5/16 | 6 | 4-1/8 |
| J1211EF | 11/32 | 6 | 4-7/16 |
| J1212EF | 3/8 | 6 | 4-5/8 |
| J25TR12C | Tool Roll | | |

ASME B107.100

- › Satin finish provides corrosion resistance and a slip-resistant grip.
- › 6 point box end allows for large wrench to fastener contact area which helps prevent rounding of the fastener.
- › Compact shank design and short length for access in confined spaces.
- › 15° angled offset box end helps keep shank clear of obstructions.
- › Standard open end.
- › Weight (lbs): 0.35



7 PIECE COMBINATION ASD WRENCH SET - 12 POINT

Product #: **J1200HASD**

| Contents | Size (in) | Point Count | Overall Length (in) |
|----------|-----------|-------------|---------------------|
| J1212ASD | 3/8 | 12 | 6 |
| J1214ASD | 7/16 | 12 | 7 |
| J1216ASD | 1/2 | 12 | 8 |
| J1218ASD | 9/16 | 12 | 8-7/8 |
| J1220ASD | 5/8 | 12 | 9-1/2 |
| J1222ASD | 11/16 | 12 | 10-1/4 |
| J1224ASD | 3/4 | 12 | 11 |
| J25TR37C | Tool Roll | | |



ASME B107.100

- › Satin finish provides corrosion resistance and a slip-resistant grip.
- › 12 point box end allows for fine indexing, helping to improve speed and access. Fits 4, 6 and 12 point fasteners.
- › Anti-Slip Design (ASD) open end.
- › Box ends incorporate the TorquePlus™ system.
- › Weight (lbs): 2.40



FACOM® 16 PIECE METRIC COMBINATION SHORT WRENCH SET

Product #: **FM-39.JE16T**

| Contents | Size (mm) | Point Count | Overall Length (in) |
|------------|-----------|-------------|---------------------|
| FM-39.3.2H | 3.2 | 6 | 3-1/32 |
| FM-39.4H | 4 | 6 | 3-1/32 |
| FM-39.5H | 5 | 6 | 3-7/32 |
| FM-39.5.5H | 5.5 | 6 | 3-5/16 |
| FM-39.6 | 6 | 12 | 3-17/32 |
| FM-39.7 | 7 | 12 | 3-17/32 |
| FM-39.8 | 8 | 12 | 3-19/32 |
| FM-39.9 | 9 | 12 | 3-27-32 |
| FM-39.10 | 10 | 12 | 4-1/16 |
| FM-39.11 | 11 | 12 | 4-9/32 |
| FM-39.12 | 12 | 12 | 5 |
| FM-39.13 | 13 | 12 | 5-9/16 |
| FM-39.14 | 14 | 12 | 5-25/32 |
| FM-39.15 | 15 | 12 | 5-31/32 |
| FM-39.16 | 16 | 12 | 6-7/32 |
| FM-39.17 | 17 | 12 | 6-1/2 |

- › Short shank and compact heads help improve access to tight spots.
- › Box end angled at 15°.
- › 12 point box end allows for fine indexing, helping to improve speed and access.
- › 6 point box end allows for large wrench to fastener contact area which helps prevent rounding the fastener.
- › Fits 4, 6 and 12 point fasteners.
- › Satin finish provides corrosion resistance and a slip-resistant grip.
- › Weight (lbs): 1.58



SATIN COMBINATION WRENCHES - 6 POINT

- › Satin finish provides corrosion resistance and a slip-resistant grip.
- › 6 point box end allows for large wrench to fastener contact area which helps prevent rounding of the fastener.
- › Fractional sizes 11/32" and smaller and sizes 1-5/16" and larger do not have the ASD feature.
- › Box ends incorporate the TorquePlus™ system.



| Product # | Size (in) | Throat | | Outside Head | | Head | | Overall Length (in) | Weight (lbs) |
|-----------|-----------|----------------|----------------|--------------------|-----------------|---------------------|----------|---------------------|--------------|
| | | Depth (in) (B) | Width (in) (C) | Thickness (in) (D) | Width (in) (C1) | Thickness (in) (D1) | | | |
| J1208HA | 1/4 | 19/64 | 39/64 | 3/16 | 27/64 | 15/64 | 4-7/8 | 0.04 | |
| J1210HA | 5/16 | 5/16 | 45/64 | 3/16 | 33/64 | 17/64 | 5-3/8 | 0.08 | |
| J1211HA | 11/32 | 11/32 | 25/32 | 3/16 | 17/32 | 7/32 | 5-5/8 | 0.08 | |
| J1212HASD | 3/8 | 13/32 | 13/16 | 3/16 | 39/64 | 5/16 | 6 | 0.10 | |
| J1214HASD | 7/16 | 17/32 | 15/16 | 15/64 | 43/64 | 21/64 | 7 | 0.14 | |
| J1216HASD | 1/2 | 39/64 | 1-5/64 | 1/4 | 49/64 | 11/32 | 8 | 0.18 | |
| J1218HASD | 9/16 | 11/16 | 1-3/16 | 9/32 | 27/32 | 23/64 | 8-7/8 | 0.21 | |
| J1220HASD | 5/8 | 3/4 | 1-21/64 | 19/64 | 15/16 | 13/32 | 9-1/2 | 0.29 | |
| J1222HASD | 11/16 | 13/16 | 1-29/64 | 5/16 | 1-1/64 | 7/16 | 10-1/4 | 0.35 | |
| J1224HASD | 3/4 | 57/64 | 1-37/64 | 11/32 | 1-3/32 | 15/32 | 11 | 0.41 | |
| J1226HASD | 13/16 | 31/32 | 1-11/16 | 23/64 | 1-11/64 | 1/2 | 11-7/8 | 0.54 | |
| J1228HASD | 7/8 | 1-1/16 | 1-13/16 | 3/8 | 1-1/4 | 33/64 | 12-1/2 | 0.64 | |
| J1230HASD | 15/16 | 1-1/8 | 1-29/32 | 13/32 | 1-27/64 | 37/64 | 13-1/4 | 0.74 | |
| J1232HASD | 1 | 1-13/64 | 2-1/64 | 13/32 | 1-13/32 | 37/64 | 14 | 0.95 | |
| J1234HASD | 1-1/16 | 1-9/32 | 2-9/64 | 45/64 | 1-31/64 | 39/64 | 15-1/4 | 1.13 | |
| J1236HASD | 1-1/8 | 1-23/64 | 2-17/64 | 3/4 | 1-21/32 | 41/64 | 15-7/8 | 1.38 | |
| J1238HASD | 1-3/16 | 1-23/64 | 2-25/64 | 3/4 | 1-21/32 | 21/32 | 15-7/8 | 1.54 | |
| J1240HASD | 1-1/4 | 1-1/2 | 2-33/64 | 53/64 | 1-3/4 | 45/64 | 16-59/64 | 1.89 | |

ASME B107.100

SATIN METRIC COMBINATION WRENCHES - 6 POINT

METRIC

- › Satin finish provides corrosion resistance and a slip-resistant grip.
- › 6 point box end allows for large wrench to fastener contact area which helps prevent rounding of the fastener.
- › Anti-Slip Design (ASD) open end.
- › Metric Sizes 9 mm and smaller do not have ASD feature.
- › Box ends incorporate the TorquePlus™ system.



| Product # | Size (mm) | Throat | | Outside Head | | Head | | Overall Length (in) | Weight (lbs) |
|------------|-----------|----------------|----------------|--------------------|-----------------|---------------------|----------|---------------------|--------------|
| | | Depth (in) (B) | Width (in) (C) | Thickness (in) (D) | Width (in) (C1) | Thickness (in) (D1) | | | |
| J1206MHA | 6 | 19/64 | 35/64 | 5/32 | 25/64 | 5/32 | 4-59/64 | 0.05 | |
| J1207MHA | 7 | 19/64 | 39/64 | 11/64 | 7/16 | 3/16 | 4-53/64 | 0.06 | |
| J1208MHA | 8 | 3/8 | 11/16 | 11/64 | 31/64 | 13/64 | 5-13/32 | 0.07 | |
| J1209MHA | 9 | 13/32 | 49/64 | 3/16 | 17/32 | 7/32 | 5-21/32 | 0.08 | |
| J1210MHASD | 10 | 31/64 | 7/8 | 7/32 | 41/64 | 5/16 | 5-29/32 | 0.13 | |
| J1211MHASD | 11 | 17/32 | 59/64 | 15/64 | 11/16 | 21/64 | 6-29/32 | 0.14 | |
| J1212MHASD | 12 | 9/16 | 1 | 1/4 | 47/64 | 21/64 | 7-45/64 | 0.17 | |
| J1213MHASD | 13 | 39/64 | 1-1/32 | 11/32 | 25/32 | 1/4 | 7-29/32 | 0.18 | |
| J1214MHASD | 14 | 11/16 | 1-3/16 | 9/32 | 55/64 | 23/64 | 8-13/16 | 0.22 | |
| J1215MHASD | 15 | 3/4 | 1-1/4 | 19/64 | 57/64 | 23/64 | 9-5/32 | 0.25 | |
| J1216MHASD | 16 | 49/64 | 1-21/64 | 5/16 | 15/16 | 13/32 | 9-35/64 | 0.26 | |
| J1217MHASD | 17 | 53/64 | 1-29/64 | 21/64 | 1-1/32 | 7/16 | 10-9/32 | 0.38 | |
| J1218MHASD | 18 | 55/64 | 1-33/64 | 11/32 | 1-5/64 | 7/16 | 10-11/16 | 0.41 | |
| J1219MHASD | 19 | 29/32 | 1-37/64 | 11/32 | 1-7/64 | 31/64 | 11-1/32 | 0.46 | |

ASME B107.100



SATIN COMBINATION WRENCHES - 12 POINT

- › Satin finish provides corrosion resistance and a slip-resistant grip.
- › 12 point box end allows for fine indexing, helping to improve speed and access. Fits 4, 6 and 12 point fasteners.
- › Anti-Slip Design (ASD) open end.
- › Fractional sizes 11/32" and smaller and sizes 1-5/16" and larger do not have the ASD feature.
- › Box ends incorporate the TorquePlus™ system.



| Product # | Size (in) | Throat Depth (in) (B) | Outside Head Width (in) (C) | Head Thickness (in) (D) | Outside Head Width (in) (C1) | Head Thickness (in) (D1) | Overall Length (in) | Weight (lbs) |
|-----------|-----------|-----------------------|-----------------------------|-------------------------|------------------------------|--------------------------|---------------------|--------------|
| J1208A | 1/4 | 19/64 | 39/64 | 3/16 | 27/64 | 15/64 | 4-7/8 | 0.04 |
| J1209A | 9/32 | 23/64 | 41/64 | 3/16 | 29/64 | 7/32 | 5-5/32 | 0.06 |
| J1210A | 5/16 | 3/8 | 45/64 | 3/16 | 33/64 | 17/64 | 5-3/8 | 0.08 |
| J1211A | 11/32 | 13/32 | 25/32 | 3/16 | 17/32 | 7/32 | 5-5/8 | 0.08 |
| J1212ASD | 3/8 | 13/32 | 13/16 | 3/16 | 39/64 | 5/16 | 6 | 0.11 |
| J1214ASD | 7/16 | 17/32 | 15/16 | 15/64 | 43/64 | 21/64 | 7 | 0.14 |
| J1216ASD | 1/2 | 39/64 | 1-5/16 | 1/4 | 49/64 | 11/32 | 8 | 0.18 |
| J1218ASD | 9/16 | 11/16 | 1-3/16 | 9/32 | 3/4 | 23/64 | 8-7/8 | 0.21 |
| J1220ASD | 5/8 | 3/4 | 1-21/64 | 19/64 | 15/16 | 13/32 | 9-1/2 | 0.29 |
| J1222ASD | 11/16 | 13/16 | 1-29/64 | 5/16 | 1-1/64 | 7/16 | 10-1/4 | 0.35 |
| J1224ASD | 3/4 | 57/64 | 1-37/64 | 11/32 | 1-3/32 | 15/32 | 11 | 0.41 |
| J1226ASD | 13/16 | 31/32 | 1-11/16 | 23/64 | 1-11/64 | 1/2 | 11-7/8 | 0.54 |
| J1228ASD | 7/8 | 1-1/16 | 1-13/16 | 3/8 | 1-1/4 | 33/64 | 12-1/2 | 0.65 |
| J1230ASD | 15/16 | 1-1/8 | 1-29/32 | 13/32 | 1-27/64 | 37/64 | 13-1/4 | 0.74 |
| J1232ASD | 1 | 1-13/64 | 2-1/64 | 13/32 | 1-13/32 | 37/64 | 14 | 0.95 |
| J1234ASD | 1-1/16 | 1-9/32 | 2-9/64 | 29/64 | 1-31/64 | 39/64 | 15-1/4 | 1.13 |
| J1236ASD | 1-1/8 | 1-23/64 | 2-17/64 | 15/32 | 1-21/32 | 41/64 | 15-7/8 | 1.38 |
| J1238ASD | 1-3/16 | 1-23/64 | 2-25/64 | 3/4 | 1-21/32 | 21/32 | 15-7/8 | 1.54 |
| J1240ASD | 1-1/4 | 1-1/2 | 2-33/64 | 33/64 | 1-3/4 | 45/64 | 16-7/8 | 1.89 |
| J1242 | 1-5/16 | 1-37/64 | 2-41/64 | 17/32 | 1-27/32 | 47/64 | 17-5/8 | 2.15 |
| J1244 | 1-3/8 | 1-21/32 | 2-49/64 | 35/64 | 1-15/16 | 25/32 | 18-1/2 | 2.34 |
| J1246 | 1-7/16 | 1-47/64 | 2-57/64 | 37/64 | 2-3/64 | 51/64 | 19-3/8 | 2.67 |
| J1248 | 1-1/2 | 1-51/64 | 3-1/64 | 39/64 | 2-1/8 | 53/64 | 20-1/4 | 3.18 |
| J1252 | 1-5/8 | 1-63/64 | 3-25/64 | 21/32 | 2-13/32 | 29/32 | 23 | 4.64 |
| J1254 | 1-11/16 | 1-63/64 | 3-25/64 | 21/32 | 2-13/32 | 29/32 | 23 | 4.74 |
| J1256 | 1-3/4 | 2-11/64 | 3-41/64 | 45/64 | 2-39/64 | 31/32 | 25 | 5.64 |
| J1258 | 1-13/16 | 2-11/64 | 3-41/64 | 45/64 | 2-39/64 | 31/32 | 25 | 5.64 |
| J1260 | 1-7/8 | 2-25/64 | 4-1/64 | 49/64 | 2-57/64 | 1-1/16 | 28 | 7.46 |
| J1264 | 2 | 2-25/64 | 4-1/64 | 49/64 | 2-57/64 | 11/16 | 28 | 7.35 |
| J1266 | 2-1/16 | 2-45/64 | 4-33/64 | 27/32 | 3-1/4 | 13/16 | 29-1/2 | 9.88 |
| J1268 | 2-1/8 | 2-45/64 | 4-33/64 | 27/32 | 3-1/4 | 13/16 | 29-1/2 | 9.74 |
| J1270 | 2-3/16 | 2-45/64 | 4-33/64 | 27/32 | 3-1/4 | 1-3/16 | 29-1/2 | 9.45 |
| J1272 | 2-1/4 | 2-45/64 | 4-33/64 | 27/32 | 3-1/4 | 1-3/16 | 29-1/2 | 8.25 |
| J1276 | 2-3/8 | 2-55/64 | 5 | 31/32 | 3-5/8 | 1-5/16 | 31-1/2 | 13.12 |
| J1280 | 2-1/2 | 3 | 5 | 31/32 | 3-5/8 | 1-5/16 | 31-1/2 | 12.49 |

See pages 595 and 598 for larger sizes.



AS 954

ASME B107.100

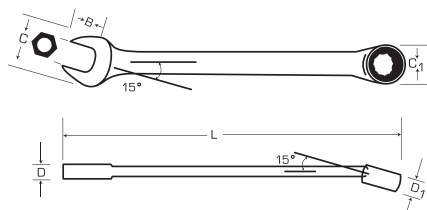

SATIN METRIC COMBINATION WRENCHES - 12 POINT



- › Satin finish provides corrosion resistance and a slip-resistant grip.
- › 12 point box end allows for fine indexing, helping to improve speed and access. Fits 4, 6 and 12 point fasteners.
- › Anti-Slip Design (ASD) open end.
- › Metric sizes 9 mm and smaller and sizes 36 mm and larger do not have the ASD feature.
- › Box ends incorporate the TorquePlus™ system.



| Product # | Size (mm) | Throat Depth (in) (B) | Outside Head Width (in) (C) | Head Thickness (in) (D) | Outside Head Width (in) (C1) | Head Thickness (in) (D1) | Overall Length (in) | Weight (lbs) |
|-----------|-----------|-----------------------|-----------------------------|-------------------------|------------------------------|--------------------------|---------------------|--------------|
| J1206MA | 6 | 19/64 | 35/64 | 5/32 | 25/64 | 5/32 | 4-29/32 | 0.05 |
| J1207MA | 7 | 5/16 | 19/32 | 11/64 | 13/32 | 15/64 | 5-5/32 | 0.06 |
| J1208MA | 8 | 25/64 | 11/16 | 3/16 | 1/2 | 17/64 | 5-13/32 | 0.07 |
| J1209MA | 9 | 13/32 | 3/4 | 3/16 | 35/64 | 17/64 | 5-21/32 | 0.08 |
| J1210MASD | 10 | 31/64 | 7/8 | 7/32 | 21/32 | 5/16 | 5-29/32 | 0.11 |
| J1211MASD | 11 | 33/64 | 59/64 | 15/64 | 11/16 | 21/64 | 6-29/32 | 0.15 |
| J1212MASD | 12 | 9/16 | 1 | 1/4 | 47/64 | 11/32 | 7-45/64 | 0.18 |
| J1213MASD | 13 | 39/64 | 1-1/32 | 1/4 | 25/32 | 11/32 | 7-29/32 | 0.21 |
| J1214MASD | 14 | 11/16 | 1-3/16 | 9/32 | 55/64 | 23/64 | 8-13/16 | 0.29 |
| J1215MASD | 15 | 3/4 | 1-1/4 | 19/64 | 7/8 | 23/64 | 9-5/32 | 0.25 |
| J1216MASD | 16 | 3/4 | 1-21/64 | 5/16 | 15/16 | 13/32 | 9-35/64 | 0.26 |
| J1217MASD | 17 | 53/64 | 1-25/64 | 21/64 | 1-1/32 | 7/16 | 10-9/32 | 0.38 |
| J1218MASD | 18 | 55/64 | 1-33/64 | 11/32 | 1-1/16 | 29/64 | 10-11/16 | 0.41 |
| J1219MASD | 19 | 29/32 | 1-37/64 | 11/32 | 1-7/64 | 15/32 | 11-1/32 | 0.46 |
| J1220MASD | 20 | 63/64 | 1-11/16 | 23/64 | 1-3/16 | 31/64 | 11-27/64 | 0.55 |
| J1221MASD | 21 | 63/64 | 1-11/16 | 23/64 | 1-3/16 | 31/64 | 11-13/16 | 0.54 |
| J1222MASD | 22 | 1-3/64 | 1-25/32 | 3/8 | 1-17/64 | 1/2 | 12-17/32 | 0.62 |
| J1223MASD | 23 | 1-1/8 | 1-57/64 | 13/32 | 1-11/32 | 35/64 | 12-59/64 | 0.77 |
| J1224MASD | 24 | 1-1/8 | 1-57/64 | 13/32 | 1-11/32 | 35/64 | 13-5/16 | 0.77 |
| J1225MASD | 25 | 1-13/64 | 2 | 27/64 | 1-27/64 | 19/32 | 14-1/16 | 0.85 |
| J1226MASD | 26 | 1-13/64 | 2-1/64 | 27/64 | 1-27/64 | 19/32 | 14-41/64 | 0.97 |
| J1227MASD | 27 | 1-7/32 | 2-9/64 | 29/64 | 1-31/64 | 39/64 | 15-15/64 | 1.17 |
| J1228MASD | 28 | 1-23/64 | 2-17/64 | 15/32 | 1-21/32 | 41/64 | 15-35/64 | 1.37 |
| J1229MASD | 29 | 1-23/64 | 2-17/64 | 15/32 | 1-21/32 | 41/64 | 15-55/64 | 1.39 |
| J1230MASD | 30 | 1-23/64 | 2-17/64 | 15/32 | 1-21/32 | 41/64 | 15-55/64 | 1.41 |
| J1232MASD | 32 | 1-1/2 | 2-33/64 | 33/64 | 1-49/64 | 45/64 | 16-59/64 | 1.82 |
| J1236M | 36 | 1-47/64 | 2-57/64 | 17/32 | 2-3/64 | 51/64 | 19-3/8 | 2.77 |
| J1241M | 41 | 2-1/64 | 3-25/64 | 41/64 | 2-27/64 | 59/64 | 23 | 4.34 |
| J1246M | 46 | 2-11/64 | 3-41/64 | 43/64 | 2-39/64 | 31/32 | 25 | 5.5 |
| J1250M | 50 | 2-25/64 | 4-1/64 | 47/64 | 2-57/64 | 1-1/16 | 28 | 6.97 |

See pages 595 and 599 for larger sizes.



ASME B107.100

PRODUCT FEATURES AND BENEFITS —



- › High performance drive configuration allows for quick and easy socket engagement to the fastener flats, not the corners.
- › Employs a radius-corner design, shifting contact area and stress away from the fastener corners and distributing contact stresses over a large area of the socket, minimizing slippage.
- › The internal design minimizes fastener rounding, helps to extend fastener life, and allows the user to more easily turn worn, rounded, or rusted fasteners.

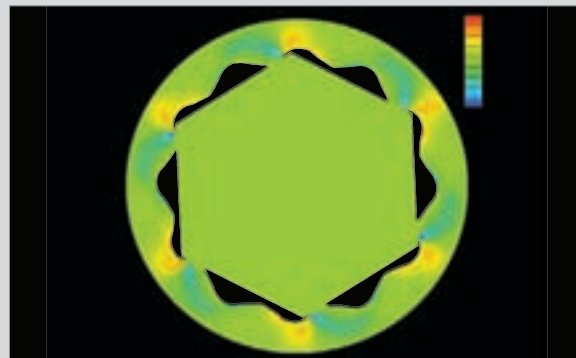

SHORT SATIN COMBINATION WRENCHES - 6 POINT

- › Satin finish provides corrosion resistance and a slip-resistant grip.
- › 6 point box end allows for large wrench to fastener contact area which helps prevent rounding of the fastener.
- › Compact shank design and short length for access in confined spaces.
- › 15° angled offset box end helps keep shank clear of obstructions.
- › Standard open end.



| Product # | Size (in) | Throat Depth (in) (B) | Outside Head Width (in) (C) | Head Thickness (in) (D) | Outside Head Width (in) (C1) | Head Thickness (in) (D1) | Overall Length (in) | Weight (lbs) |
|-----------|-----------|-----------------------|-----------------------------|-------------------------|------------------------------|--------------------------|---------------------|--------------|
| J1204EF | 1/8 | 11/64 | 11/32 | 1/8 | 9/32 | 1/8 | 2-49/64 | 0.01 |
| J1205EF | 5/32 | 13/64 | 13/32 | 1/8 | 19/64 | 1/8 | 2-57/64 | 0.01 |
| J1206EF | 3/16 | 15/64 | 15/32 | 1/8 | 11/32 | 5/32 | 3-1/4 | 0.02 |
| J1207EF | 7/32 | 1/4 | 1/8 | 1/8 | 3/8 | 5/32 | 3-1/8 | 0.02 |
| J1208EF | 1/4 | 19/64 | 9/16 | 5/32 | 27/64 | 3/16 | 3-17/64 | 0.03 |
| J1209EF | 9/32 | 21/64 | 5/8 | 5/32 | 7/16 | 3/16 | 3-7/16 | 0.04 |
| J1210EF | 5/16 | 3/8 | 11/16 | 5/32 | 1/2 | 1/4 | 4-1/8 | 0.04 |
| J1211EF | 11/32 | 25/64 | 47/64 | 3/16 | 17/32 | 1/4 | 4-7/16 | 0.05 |
| J1212EF | 3/8 | 7/16 | 53/64 | 3/16 | 37/64 | 1/4 | 4-5/8 | 0.07 |
| J1214EF | 7/16 | 33/64 | 7/8 | 7/32 | 5/8 | 9/32 | 5-1/16 | 0.12 |
| J1216EF | 1/2 | 19/32 | 1 | 7/32 | 3/4 | 5/16 | 5-1/4 | 0.16 |
| J1218EF | 9/16 | 43/64 | 1-1/8 | 1/4 | 51/64 | 11/32 | 5-7/8 | 0.16 |
| J1220EF | 5/8 | 47/64 | 1-17/64 | 9/32 | 57/64 | 3/8 | 6-3/16 | 0.17 |

ASME B107.100

FACOM® SHORT SATIN METRIC COMBINATION WRENCHES - 6 POINT

- › Short shank and compact heads help improve access to tight spots.
- › Box end angled at 15°.
- › Satin finish provides corrosion resistance and a slip-resistant grip.



| Product # | Size (mm) | Outside Head Width (in) (C) | Head Thickness (in) (D) | Outside Head Width (in) (C1) | Head Thickness (in) (D1) | Overall Length (in) | Weight (lbs) |
|------------|-----------|-----------------------------|-------------------------|------------------------------|--------------------------|---------------------|--------------|
| FM-39.3.2H | 3.2 | 25/64 | 1/8 | 9/32 | 1/8 | 3-1/32 | 0.02 |
| FM-39.4H | 4 | 25/64 | 1/8 | 5/16 | 1/8 | 3-1/32 | 0.01 |
| FM-39.5H | 5 | 15/32 | 5/32 | 23/64 | 5/32 | 3-7/32 | 0.02 |
| FM-39.5.5H | 5.5 | 15/32 | 5/32 | 3/8 | 5/32 | 3-5/16 | 0.02 |

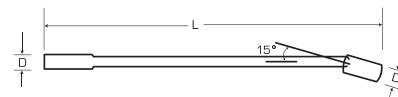
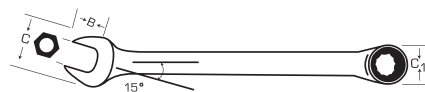

SHORT SATIN COMBINATION WRENCHES - 12 POINT

- › Satin finish provides corrosion resistance and a slip-resistant grip.
- › 12 point box end allows for fine indexing, helping to improve speed and access. Fits 4, 6 and 12 point fasteners.
- › Compact shank design and short length for access in confined spaces.
- › 15° angled offset box end helps keep shank clear of obstructions.
- › Standard open end.



| Product # | Size (in) | Throat Depth (in) (B) | Outside Head Width (in) (C) | Head Thickness (in) (D) | Outside Head Width (in) (C1) | Head Thickness (in) (D1) | Overall Length (in) | Weight (lbs) |
|-----------|-----------|-----------------------|-----------------------------|-------------------------|------------------------------|--------------------------|---------------------|--------------|
| J1208TF | 1/4 | 19/64 | 17/32 | 1/8 | 25/64 | 5/16 | 3-1/4 | 0.02 |
| J1209TF | 9/32 | 21/64 | 5/8 | 5/32 | 7/16 | 3/16 | 3-7/16 | 0.04 |
| J1210TF | 5/16 | 3/8 | 41/64 | 3/16 | 5/32 | 7/32 | 3-1/2 | 0.04 |
| J1211TF | 11/32 | 25/64 | 47/64 | 3/16 | 17/32 | 1/4 | 4-7/16 | 0.05 |
| J1212TF | 3/8 | 7/16 | 3/4 | 13/64 | 35/64 | 1/4 | 4-5/8 | 0.07 |
| J1214TF | 7/16 | 33/64 | 7/8 | 15/64 | 5/8 | 17/64 | 5-1/16 | 0.10 |
| J1216TF | 1/2 | 19/32 | 1 | 1/4 | 23/64 | 19/64 | 5-11/16 | 0.11 |
| J1218TF | 9/16 | 43/64 | 1-1/8 | 9/32 | 51/64 | 21/64 | 5-13/16 | 0.16 |
| J1220TF | 5/8 | 47/64 | 1-17/64 | 23/64 | 57/64 | 11/32 | 6-3/16 | 0.18 |
| J1222TF | 11/16 | 13/16 | 1-25/64 | 11/32 | 31/32 | 3/8 | 7-1/16 | 0.23 |
| J1224TF | 3/4 | 57/64 | 1-33/64 | 3/8 | 1-3/64 | 13/32 | 8-1/16 | 0.33 |

ASME B107.100

FACOM® SHORT SATIN METRIC COMBINATION WRENCHES - 12 POINT



- › Short shank and compact heads help improve access to tight spots.
- › Box end angled at 15°.
- › 12 point box end allows for fine indexing, helping to improve speed and access.
- › Fits 4, 6 and 12 point fasteners.
- › Satin finish provides corrosion resistance and a slip-resistant grip.



| Product # | Size (mm) | Outside Head Width (in) (C) | Head Thickness (in) (D) | Outside Head Width (in) (C1) | Head Thickness (in) (D1) | Overall Length (in) | Weight (lbs) |
|-----------|-----------|-----------------------------|-------------------------|------------------------------|--------------------------|---------------------|--------------|
| FM-39.6 | 6 | 19/32 | 5/32 | 13/32 | 13/64 | 3-17/32 | 0.04 |
| FM-39.7 | 7 | 19/32 | 5/32 | 29/64 | 13/64 | 3-17/32 | 0.03 |
| FM-39.8 | 8 | 43/64 | 11/64 | 31/64 | 15/64 | 3-19/32 | 0.04 |
| FM-39.9 | 9 | 49/64 | 3/16 | 35/64 | 15/64 | 3-27/32 | 0.05 |
| FM-39.10 | 10 | 27/32 | 13/64 | 39/64 | 1/4 | 4-1/16 | 0.06 |
| FM-39.11 | 11 | 15/16 | 13/64 | 21/32 | 17/64 | 4-9/32 | 0.08 |
| FM-39.12 | 12 | 1-1/32 | 7/32 | 45/64 | 19/64 | 5 | 0.1 |
| FM-39.13 | 13 | 1-7/64 | 15/64 | 49/64 | 5/16 | 5-9/16 | 0.12 |
| FM-39.14 | 14 | 1-3/16 | 15/64 | 13/16 | 21/64 | 5-25/32 | 0.15 |
| FM-39.15 | 15 | 1-17/64 | 1/4 | 7/8 | 23/64 | 5-31/32 | 0.17 |
| FM-39.16 | 16 | 1-23/64 | 17/64 | 59/64 | 3/8 | 6-7/32 | 0.19 |
| FM-39.17 | 17 | 1-7/16 | 17/64 | 63/64 | 25/64 | 6-1/2 | 0.23 |

SATIN X-LARGE COMBINATION WRENCHES - 12 POINT

- › Satin finish provides corrosion resistance and a slip-resistant grip.
- › For use on extra large fasteners.
- › Used in Mining, Oil and Gas, Industrial Construction.
- › Forged heads with machined openings.
- › 12 point box end allows for fine indexing, helping to improve speed and access. Fits 4, 6 and 12 point.
- › Box end is countersunk for easy application to the fastener.



| Product # | Size (in) | Outside Head Width (in) (C) | Outside Head Width (in) (C1) | Head Thickness (in) (D1) | Overall Length (in) | Weight (lbs) |
|--------------|-----------|-----------------------------|------------------------------|--------------------------|---------------------|--------------|
| J1282 | 2-9/16 | 4-1/2 | 3-5/8 | 1-9/16 | 29-3/4 | 13 |
| J1284 | 2-9/16 | 4-3/4 | 3-3/4 | 1-5/8 | 29-3/4 | 13 |
| J1288 | 2-3/4 | 4-3/4 | 3-3/4 | 1-5/8 | 29-3/4 | 13 |



SATIN X-LARGE METRIC COMBINATION WRENCHES - 12 POINT

METRIC

- › Satin finish provides corrosion resistance and a slip-resistant grip.
- › For use on extra large fasteners.
- › Used in Mining, Oil and Gas, Industrial Construction.
- › Forged heads with machined openings.
- › 12 point box end allows for fine indexing, helping to improve speed and access. Fits 4, 6 and 12 point.
- › Box end is countersunk for easy application to the fastener.



| Product # | Size (mm) | Outside Head Width (in) (C) | Outside Head Width (in) (C1) | Head Thickness (in) (D1) | Overall Length (in) | Weight (lbs) |
|---------------|-----------|-----------------------------|------------------------------|--------------------------|---------------------|--------------|
| J1255M | 55 | 4-1/4 | 3-1/4 | 1-3/16 | 28-3/4 | 10 |
| J1260M | 60 | 4-1/2 | 3-5/8 | 1-9/16 | 29-3/4 | 13 |
| J1265M | 65 | 4-1/2 | 3-5/8 | 1-9/16 | 29-3/4 | 13 |
| J1270M | 70 | 4-3/4 | 3-3/4 | 1-5/8 | 29-3/4 | 13 |



15 PIECE METRIC BLACK OXIDE COMBINATION ASD WRENCH SET - 12 POINT

METRIC

Product #: **J1200F-MBASD**

| Contents | Size (mm) | Point Count | Overall Length (in) |
|------------|-----------|-------------|---------------------|
| J1207MBA | 7 | 12 | 5-5/32 |
| J1208MBA | 8 | 12 | 5-13/32 |
| J1209MBA | 9 | 12 | 5-21/32 |
| J1210MBASD | 10 | 12 | 5-29/32 |
| J1211MBASD | 11 | 12 | 6-29/32 |
| J1212MBASD | 12 | 12 | 7-45/64 |
| J1213MBASD | 13 | 12 | 7-29/32 |
| J1214MBASD | 14 | 12 | 8-13/16 |
| J1215MBASD | 15 | 12 | 9-5/32 |
| J1216MBASD | 16 | 12 | 9-35/64 |
| J1217MBASD | 17 | 12 | 10-9/32 |
| J1218MBASD | 18 | 12 | 10-11/16 |
| J1219MBASD | 19 | 12 | 11-1/32 |
| J1220MBASD | 20 | 12 | 11-27/64 |
| J1221MBASD | 21 | 12 | 11-13/16 |
| J25TR40C | Tool Roll | | |



ASME B107.100

- ▶ Non-reflective black oxide finish for use where non-plated products are required.
- ▶ 12 point box end allows for fine indexing, helping to improve speed and access. Fits 4, 6 and 12 point fasteners.
- ▶ Anti-Slip Design (ASD) open end. Metric sizes 9 mm and smaller do not have ASD feature.
- ▶ Box ends incorporate the TorquePlus™ system.
- ▶ Weight (lbs): 5.10

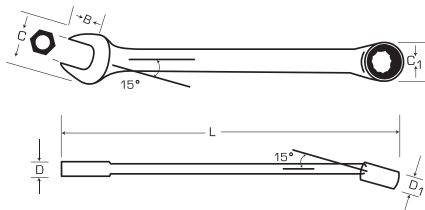

FEATURES AND BENEFITS – ANTI-SLIP DESIGN

Wrenches with the Anti-Slip Design (ASD) apply force to the flat sides of the fasteners, and not the corners. This feature helps to prevent rounding, and permits higher torques.

14 PIECE BLACK OXIDE COMBINATION ASD WRENCH SET - 12 POINT

Product #: **J1200FBASD**

| Contents | Size (in) | Point Count | Overall Length (in) |
|-----------|-----------|-------------|---------------------|
| J1212BASD | 3/8 | 12 | 6 |
| J1214BASD | 7/16 | 12 | 7 |
| J1216BASD | 1/2 | 12 | 8-7/8 |
| J1218BASD | 9/16 | 12 | 8-7/8 |
| J1220BASD | 5/8 | 12 | 9-1/2 |
| J1222BASD | 11/16 | 12 | 10-1/4 |
| J1224BASD | 3/4 | 12 | 11 |
| J1226BASD | 13/16 | 12 | 11-7/8 |
| J1228BASD | 7/8 | 12 | 12-1/2 |
| J1230BASD | 15/16 | 12 | 13-1/4 |
| J1232BASD | 1 | 12 | 14 |
| J1234BASD | 1-1/16 | 12 | 15-1/4 |
| J1238BASD | 1-1/8 | 12 | 15-7/8 |
| J1240BASD | 1-1/4 | 12 | 16-7/8 |
| J25TR41C | Tool Roll | | |



ASME B107.100

- ▶ Non-reflective black oxide finish for use where non-plated products are required.
- ▶ 12 point box end allows for fine indexing, helping to improve speed and access. Fits 4, 6 and 12 point fasteners.
- ▶ Anti-Slip Design (ASD) open end.
- ▶ Box ends incorporate the TorquePlus™ system.
- ▶ Weight (lbs): 9.70



7 PIECE BLACK OXIDE COMBINATION ASD WRENCH SET - 12 POINT

Product #: **J1200HBASD**

- › Non-reflective black oxide finish for use where non-plated products are required.
- › 12 point box end allows for fine indexing, helping to improve speed and access. Fits 4, 6 and 12 point fasteners.
- › Anti-Slip Design (ASD) open end.
- › Box ends incorporate the TorquePlus™ system.
- › Weight (lbs): 2.25



| Contents | Size (in) | Point Count | Overall Length (in) |
|-----------|-----------|-------------|---------------------|
| J1212BASD | 3/8 | 12 | 6 |
| J1214BASD | 7/16 | 12 | 7 |
| J1216BASD | 1/2 | 12 | 8-7/8 |
| J1218BASD | 9/16 | 12 | 8-7/8 |
| J1220BASD | 5/8 | 12 | 9-1/2 |
| J1222BASD | 11/16 | 12 | 10-1/4 |
| J1224BASD | 3/4 | 12 | 11 |
| J25TR37C | Tool Roll | | |

ASME B107.100



BLACK OXIDE COMBINATION WRENCHES - 12 POINT

- › Non-reflective black oxide finish for use where non-plated products are required.
- › 12 point box end allows for fine indexing, helping to improve speed and access. Fits 4, 6 and 12 point fasteners.
- › The box end is countersunk for easy application to the fastener.
- › 15° angled offset box end helps keep shank clear of obstructions.
- › Anti-Slip Design (ASD) open end.
- › Sizes 1-5/16" and larger do not have ASD feature.
- › Box ends incorporate the TorquePlus™ system.



| Product # | Size (in) | Throat Depth (in) (B) | Outside Head Width (in) (C) | Head Thickness (in) (D) | Outside Head Width (in) (C1) | Head Thickness (in) (D1) | Overall Length (in) | Weight (lbs) |
|-----------|-----------|-----------------------|-----------------------------|-------------------------|------------------------------|--------------------------|---------------------|--------------|
| J1212BASD | 3/8 | 27/64 | 13/16 | 7/32 | 39/64 | 5/16 | 6 | 0.10 |
| J1214BASD | 7/16 | 17/32 | 15/16 | 1/4 | 43/64 | 21/64 | 7 | 0.22 |
| J1216BASD | 1/2 | 39/64 | 1-5/64 | 17/64 | 49/64 | 11/32 | 8-7/8 | 0.26 |
| J1218BASD | 9/16 | 11/16 | 1-3/16 | 19/64 | 27/32 | 23/64 | 8-7/8 | 0.21 |
| J1220BASD | 5/8 | 3/4 | 1-21/64 | 5/16 | 15/16 | 13/32 | 9-1/2 | 0.29 |
| J1222BASD | 11/16 | 13/16 | 1-29/64 | 11/32 | 1-1/4 | 7/16 | 10-1/4 | 0.35 |
| J1224BASD | 3/4 | 57/64 | 1-37/64 | 23/64 | 1-3/32 | 15/32 | 11 | 0.41 |
| J1226BASD | 13/16 | 31/32 | 1-11/16 | 3/8 | 1-11/64 | 1/2 | 11-7/8 | 0.54 |
| J1228BASD | 7/8 | 1-1/16 | 1-13/16 | 13/32 | 1-1/4 | 17/32 | 12-1/2 | 0.64 |
| J1230BASD | 15/16 | 1-1/8 | 1-29/32 | 1/8 | 1-11/32 | 9/16 | 13-1/4 | 0.74 |
| J1232BASD | 1 | 1-13/64 | 2-1/64 | 29/64 | 1-13/32 | 19/32 | 14 | 0.95 |
| J1234BASD | 1-1/16 | 1-9/32 | 2-9/64 | 15/32 | 1-31/64 | 5/8 | 15-1/4 | 1.13 |
| J1236BASD | 1-1/8 | 1-23/64 | 2-17/64 | 33/64 | 1-21/32 | 41/64 | 15-7/8 | 1.38 |
| J1240BASD | 1-1/4 | 1-1/2 | 2-33/64 | 17/32 | 1-3/4 | 45/64 | 16-7/8 | 1.89 |
| J1242B | 1-5/16 | 1-37/64 | 2-41/64 | 17/32 | 2-1/8 | 47/64 | 17-5/8 | 2.15 |
| J1244B | 1-3/8 | 1-21/32 | 2-49/64 | 35/64 | 1-15/76 | 25/32 | 18-1/2 | 2.34 |
| J1246B | 1-7/16 | 1-47/64 | 2-57/64 | 37/64 | 23/64 | 51/64 | 19-3/8 | 2.67 |
| J1248B | 1-1/2 | 1-3/4 | 3 | 5/8 | 2-1/8 | 53/64 | 20-1/8 | 2.15 |
| J1252B | 1-5/8 | 1-63/64 | 3-25/64 | 21/32 | 2-13/32 | 29/32 | 23 | 4.64 |
| J1254B | 1-11/16 | 1-63/64 | 3-25/64 | 21/32 | 2-13/32 | 29/32 | 23 | 4.74 |
| J1256B | 1-3/4 | 1-3/4 | 3-41/64 | 45/64 | 2-39//64 | 31/32 | 25 | 5.64 |
| J1258B | 1-13/16 | 1-13/16 | 3-41/64 | 45/64 | 2-39//64 | 31/32 | 25 | 5.59 |
| J1260B | 1-7/8 | 1-7/8 | 4-1/64 | 49/64 | 2-57/64 | 1-1/16 | 28 | 7.46 |
| J1264B | 2 | 2 | 4-1/64 | 49/64 | 2-57/64 | 1-1/16 | 28 | 7.35 |

See pages 595 and 598 for larger sizes.



AS 954

ASME B107.100

BLACK OXIDE METRIC COMBINATION WRENCHES - 12 POINT



- › Non-reflective black oxide finish for use where non-plated products are required.
- › 12 point box end allows for fine indexing, helping to improve speed and access. Fits 4, 6 and 12 point fasteners.
- › The box end is countersunk for easy application to the fastener.
- › 15° angled offset box end helps keep shank clear of obstructions.
- › Anti-Slip Design (ASD) open end.
- › Inch sizes 1-5/16" and larger do not have ASD feature.
- › Box ends incorporate the TorquePlus™ system.



| Product # | Size (mm) | Throat Depth (in) (B) | Outside Head Width (in) (C) | Head Thickness (in) (D) | Outside Head Width (in) (C1) | Head Thickness (in) (D1) | Overall Length (in) | Weight (lbs) |
|------------|-----------|-----------------------|-----------------------------|-------------------------|------------------------------|--------------------------|---------------------|--------------|
| J1207MBA | 7 | 5/16 | 37/64 | 3/16 | 27/64 | 13/64 | 5-5/32 | 0.04 |
| J1208MBA | 8 | 25/64 | 11/16 | 13/64 | 17/32 | 9/32 | 5-13/32 | 0.07 |
| J1209MBA | 9 | 13/32 | 47/64 | 13/64 | 17/32 | 9/32 | 5-21/32 | 0.08 |
| J1210MBASD | 10 | 31/64 | 7/8 | 15/64 | 41/64 | 5/16 | 5-29/32 | 0.13 |
| J1211MBASD | 11 | 17/32 | 15/16 | 1/4 | 11/16 | 21/64 | 6-29/32 | 0.14 |
| J1212MBASD | 12 | 9/16 | 1-7/64 | 1/4 | 47/64 | 21/64 | 7-45/64 | 0.17 |
| J1213MBASD | 13 | 39/64 | 1-3/64 | 17/64 | 25/32 | 11/32 | 7-29/32 | 0.18 |
| J1214MBASD | 14 | 11/16 | 1-3/16 | 19/64 | 55/64 | 23/64 | 8-13/16 | 0.22 |
| J1215MBASD | 15 | 23/32 | 1-7/32 | 19/64 | 7/8 | 23/64 | 9-5/32 | 0.25 |
| J1216MBASD | 16 | 3/4 | 1-21/64 | 21/64 | 61/64 | 13/32 | 9-35/64 | 0.26 |
| J1217MBASD | 17 | 53/64 | 1-29/64 | 11/32 | 1-1/32 | 7/16 | 10-9/32 | 0.38 |
| J1218MBASD | 18 | 55/64 | 1-33/64 | 21/64 | 1-1/16 | 29/64 | 10-11/16 | 0.41 |
| J1219MBASD | 19 | 29/32 | 1-37/64 | 23/64 | 1-7/64 | 15/32 | 11-1/32 | 0.46 |
| J1220MBASD | 20 | 63/64 | 1-11/16 | 25/64 | 1-3/16 | 1/2 | 11-27/64 | 0.55 |
| J1221MBASD | 21 | 63/64 | 1-11/16 | 13/32 | 1-3/16 | 1/2 | 11-13/16 | 0.54 |
| J1222MBASD | 22 | 1-3/64 | 1-51/64 | 13/32 | 1-9/32 | 35/64 | 12-17/32 | 0.62 |
| J1223MBASD | 23 | 1-1/8 | 1-29/32 | 13/32 | 1-11/32 | 9/16 | 12-59/64 | 0.77 |
| J1224MBASD | 24 | 1-1/8 | 1-61/64 | 13/32 | 1-11/32 | 9/16 | 13-5/16 | 0.77 |

See pages 595 and 599 for larger sizes.



ASME B107.100

BLACK OXIDE X-LARGE COMBINATION WRENCHES - 12 POINT

- › Black Oxide Finish.
- › For use on extra large fasteners.
- › Used in Mining, Oil and Gas, Industrial Construction.
- › Forged heads with machined openings.
- › 12 point box end allows for fine indexing, helping to improve speed and access. Fits 4, 6 and 12 point.
- › Box end is countersunk for easy application to the fastener.



| Product # | Size (in) | Outside Head Width (in) (C) | Outside Head Width (in) (C1) | Head Thickness (in) (D1) | Overall Length (in) | Weight (lbs) |
|-----------|-----------|-----------------------------|------------------------------|--------------------------|---------------------|--------------|
| J1290 | 2-3/16 | 5-1/2 | 4-1/4 | 1-11/16 | 34 | 18 |
| J1292 | 2-7/8 | 5-1/2 | 4-3/4 | 1-11/16 | 34 | 18 |
| J1294 | 2-15/16 | 5-1/2 | 4-3/4 | 1-11/16 | 34 | 18 |
| J1296 | 3 | 5-1/2 | 4-3/4 | 1-11/16 | 34 | 18 |
| J1298 | 3-1/16 | 5-1/2 | 4-3/4 | 1-11/16 | 34 | 18 |
| J12100 | 3-1/8 | 5-1/2 | 4-3/4 | 1-11/16 | 34 | 18 |
| J12104 | 3-1/4 | 7 | 5-1/2 | 2-1/4 | 37 | 35 |
| J12108 | 3-3/8 | 7 | 5-1/2 | 2-1/4 | 37 | 35 |
| J12112 | 3-1/2 | 7 | 5-7/8 | 2-1/4 | 37 | 35 |
| J12116 | 3-5/8 | 7 | 5-7/8 | 2-1/4 | 37 | 35 |
| J12120 | 3-3/4 | 7 | 6-1/8 | 2-1/4 | 37 | 35 |
| J12124 | 3-7/8 | 7 | 6-1/8 | 2-1/4 | 37 | 35 |
| J12128 | 4 | 7 | 6-1/8 | 2-1/4 | 37 | 35 |



BLACK OXIDE X-LARGE METRIC COMBINATION WRENCHES - 12 POINT

METRIC

- › Black Oxide Finish.
- › For use on extra large fasteners.
- › Used in Mining, Oil and Gas, Industrial Construction.
- › Forged heads with machined openings.
- › 12 point box end allows for fine indexing, helping to improve speed and access. Fits 4, 6 and 12 point.
- › Box end is countersunk for easy application to the fastener.



| Product # | Size (mm) | Outside Head Width (in) (C) | Outside Head Width (in) (C1) | Head Thickness (in) (D1) | Overall Length (in) | Weight (lbs) |
|-----------|-----------|-----------------------------|------------------------------|--------------------------|---------------------|--------------|
| J1273M | 73 | 5-1/2 | 4-3/4 | 1-11/16 | 34 | 18 |
| J1275M | 75 | 5-1/2 | 4-3/4 | 1-11/16 | 34 | 18 |
| J1280M | 80 | 5-1/2 | 4-3/4 | 1-11/16 | 34 | 18 |

7 PIECE FLEX-HEAD WRENCH SET - 12 POINT

Product #: J1270A

- › Satin finish provides corrosion resistance and a slip-resistant grip.
- › 12 point box end allows for fine indexing, helping to improve speed and access. Fits 4, 6 and 12 point fasteners.
- › Use the swiveling box end to break or cinch bolts in difficult locations.
- › Heat-treated alloy steels produce a shank with high leverage.
- › Box ends incorporate the TorquePlus™ system.
- › Weight (lbs): 2.91



| Contents | Size (in) | Overall Length (in) |
|----------|-----------|---------------------|
| J1270-12 | 3/8 | 6 |
| J1270-14 | 7/16 | 6-7/8 |
| J1270-16 | 1/2 | 7-3/4 |
| J1270-18 | 9/16 | 8-5/8 |
| J1270-20 | 5/8 | 9-1/2 |
| J1270-22 | 11/16 | 10-3/8 |
| J1270-24 | 3/4 | 11-1/4 |
| J25TR01C | Tool Roll | |



4 PIECE FLEX-HEAD WRENCH SET - 12 POINT

Product #: J1270B

- › Satin finish provides corrosion resistance and a slip-resistant grip.
- › 12 point box end allows for fine indexing, helping to improve speed and access. Fits 4, 6 and 12 point fasteners.
- › Use the swiveling box end to break or cinch bolts in difficult locations.
- › Heat-treated alloy steels produce a shank with high leverage.
- › Box ends incorporate the TorquePlus™ system.
- › Weight (lbs): 0.88



| Contents | Size (in) | Overall Length (in) |
|----------|-----------|---------------------|
| J1270-14 | 7/16 | 6-7/8 |
| J1270-16 | 1/2 | 7-3/4 |
| J1270-18 | 9/16 | 8-5/8 |
| J1270-20 | 5/8 | 9-1/2 |
| J25TR18C | Tool Roll | |



SATIN COMBINATION FLEX-HEAD WRENCHES - 12 POINT

- › Satin finish provides corrosion resistance and a slip-resistant grip.
- › 12 point box end allows for fine indexing, helping to improve speed and access. Fits 4, 6 and 12 point fasteners.
- › Use the swiveling box end to break or cinch bolts in difficult locations.
- › Heat-treated alloy steels produce a shank with high leverage.
- › Box ends incorporate the TorquePlus™ system.

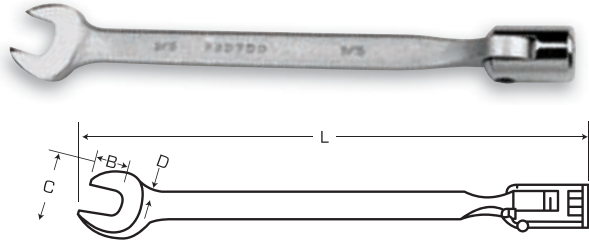

| Product # | Size (in) | Throat Depth (in) (B) | Outside Head Width (in) (C) | Head Thickness (in) (D) | Overall Length (in) | Weight (lbs) |
|-----------|-----------|-----------------------|-----------------------------|-------------------------|---------------------|--------------|
| J1270-12 | 3/8 | 27/64 | 55/64 | 15/64 | 6 | 0.14 |
| J1270-14 | 7/16 | 1/2 | 1 | 1/4 | 6-7/8 | 0.20 |
| J1270-16 | 1/2 | 37/64 | 1-3/32 | 9/32 | 7-3/4 | 0.25 |
| J1270-18 | 9/16 | 21/32 | 1-15/64 | 5/16 | 8-5/8 | 0.36 |
| J1270-20 | 5/8 | 23/32 | 1-23/32 | 21/64 | 9-1/2 | 0.46 |
| J1270-22 | 11/16 | 51/64 | 1-1/2 | 11/32 | 10-3/8 | 0.58 |
| J1270-24 | 3/4 | 7/8 | 1-41/64 | 23/64 | 11-1/4 | 0.46 |
| J1270-28 | 7/8 | 1-1/64 | 1-27/32 | 13/32 | 13 | 0.93 |



FACOM® 3 PIECE DOUBLE FLEX-HEAD SOCKET WRENCH SET

Product #: FF-66A.JU3



- › Satin chrome finish.
- › Spring-steadied pivoting 12 point socket.
- › Strength to ISO 1711-1, DIN 899, NF ISO 1711-1.
- › Weight (lbs): 1.55

| Contents | Size (in) | Point Count | Overall Length (in) |
|----------------|------------|-------------|---------------------|
| FF-66A.1/2X9/1 | 1/2 x 9/16 | 12 | 9-1/4 |
| FF-66A.3/8X7/1 | 3/8 x 7/16 | 12 | 6-1/2 |
| FF-66A.5/8X3/4 | 5/8 x 3/4 | 12 | 11-1/4 |



FACOM® 9 PIECE DOUBLE FLEX-HEAD SOCKET WRENCH SET

Product #: FM-66A.JE9T



- › Satin chrome finish.
- › Spring-steadied pivoting 12 point socket.
- › Strength to ISO 1711-1, DIN 899, NF ISO 1711-1.
- › Weight (lbs): 4.35

| Contents | Size (mm) | Point Count | Overall Length (in) |
|--------------|-----------|-------------|---------------------|
| FM-66A.6X7 | 6 X 7 | 12 | 7-11/16 |
| FM-66A.8X9 | 8 X 9 | 12 | 7-11/16 |
| FM-66A.10X11 | 10 X 11 | 12 | 7-7/8 |
| FM-66A.12X13 | 12 X 13 | 12 | 9-1/4 |
| FM-66A.14X15 | 14 X 15 | 12 | 9-1/4 |
| FM-66A.16X17 | 16 X 17 | 12 | 9-7/16 |
| FM-66A.18X19 | 18 X 19 | 12 | 11-7/32 |
| FM-66A.20X22 | 20 X 22 | 12 | 11-7/32 |
| FM-66A.21X23 | 21 X 23 | 12 | 11-13/32 |



FACOM® SATIN DOUBLE FLEX-HEAD SOCKET WRENCHES - 12 POINT

- › Satin chrome finish.
- › Spring-steadied pivoting 12 point socket.
- › Strength to ISO 1711-1, DIN 899, NF ISO 1711-1.



| Product # | Size (in) | Outside Head Width (in) (C) | Outside Head Width (in) (C1) | Overall Length (in) | Weight (lbs) |
|-----------------------|------------|-----------------------------|------------------------------|---------------------|--------------|
| FF-66A.3/8X7/1 | 3/8 x 7/16 | 19/32 | 21/32 | 6-1/2 | 0.26 |
| FF-66A.1/2X9/1 | 1/2 x 9/16 | 3/4 | 13/16 | 9-1/4 | 0.47 |
| FF-66A.5/8X3/4 | 5/8 x 3/4 | 29/32 | 1-1/32 | 11-1/4 | 0.82 |

FACOM® SATIN METRIC DOUBLE FLEX-HEAD SOCKET WRENCHES - 12 POINT

- › Satin chrome finish.
- › Spring-steadied pivoting 12 point socket.
- › Strength to ISO 1711-1, DIN 899, NF ISO 1711-1.



| Product # | Size (mm) | Outside Head Width (in) (C) | Outside Head Width (in) (C1) | Overall Length (in) | Weight (lbs) |
|---------------------|-----------|-----------------------------|------------------------------|---------------------|--------------|
| FM-66A.6X7 | 6 X 7 | 19/32 | 29/64 | 7-11/16 | 0.20 |
| FM-66A.8X9 | 8 X 9 | 19/32 | 35/64 | 7-11/16 | 0.21 |
| FM-66A.10X11 | 10 X 11 | 45/64 | 21/32 | 7-7/8 | 0.24 |
| FM-66A.12X13 | 12 X 13 | 53/64 | 3/4 | 9-1/4 | 0.42 |
| FM-66A.14X15 | 14 X 15 | 29/32 | 55/64 | 9-1/4 | 0.44 |
| FM-66A.16X17 | 16 X 17 | 29/32 | 15/16 | 9-7/16 | 0.49 |
| FM-66A.18X19 | 18 X 19 | 63/64 | 1-1/32 | 11-7/32 | 0.77 |
| FM-66A.20X22 | 20 X 22 | 1-5/64 | 1-13/64 | 11-7/32 | 0.76 |
| FM-66A.21X23 | 21 X 23 | 1-1/8 | 1-15/64 | 11-13/32 | 0.82 |
| FM-66A.24X27 | 24 X 27 | 1-19/64 | 1-7/16 | 13-3/16 | 1.15 |
| FM-66A.30X32 | 30 X 32 | 1-19/32 | 1-11/16 | 13-1/8 | 1.32 |

10 PIECE FACOM® ANGLED SOCKET WRENCH SET

Product #: **FF-75.JU10**

| Contents | Size (in) | Overall Length (in) |
|-------------|-----------|---------------------|
| FF-75.5/16 | 5/16 | 4-31/64 |
| FF-75.3/8 | 3/8 | 5-5/64 |
| FF-75.7/16 | 7/16 | 5-23/64 |
| FF-75.1/2 | 1/2 | 5-63/64 |
| FF-75.9/16 | 9/16 | 6-21/32 |
| FF-75.5/8 | 5/8 | 7-1/64 |
| FF-75.11/16 | 11/16 | 7-43/64 |
| FF-75.3/4 | 3/4 | 8-1/32 |
| FF-75.13/16 | 13/16 | 8-45/64 |
| FF-75.7/8 | 7/8 | 9-29/64 |

- › Satin finish.
- › Angle and through-hole design helps accommodate threaded rods or a bar for extra leverage, without affecting wrench strength.
- › Deep recess at one end and open end socket at the other fit over protruding studs.
- › Weight (lbs): 6.08



FACOM® SATIN ANGLED OPEN-SOCKET WRENCHES - 6 POINT X 6 POINT



| Product # | Size (in) | Overall Length (in) | Weight (lbs) |
|-------------|-----------|---------------------|--------------|
| FF-75.1/4 | 1/4 | 4-1/64 | 0.07 |
| FF-75.5/16 | 5/16 | 4-31/64 | 0.13 |
| FF-75.3/8 | 3/8 | 5-5/64 | 0.20 |
| FF-75.7/16 | 7/16 | 5-23/64 | 0.25 |
| FF-75.1/2 | 1/2 | 5-63/64 | 0.38 |
| FF-75.9/16 | 9/16 | 6-21/32 | 0.49 |
| FF-75.5/8 | 5/8 | 7-1/64 | 0.62 |
| FF-75.11/16 | 11/16 | 7-43/64 | 0.80 |
| FF-75.3/4 | 3/4 | 8-1/32 | 0.94 |
| FF-75.13/16 | 13/16 | 8-45/64 | 1.08 |
| FF-75.7/8 | 7/8 | 9-29/64 | 1.38 |
| FF-75.15/16 | 15/16 | 9-27/32 | 1.45 |
| FF-75.1 | 1 | 10-5/8 | 1.75 |

- › Satin finish.
- › Angle and through-hole design helps accommodate threaded rods or a bar for extra leverage, without affecting wrench strength.
- › Deep recess at one end and open end socket at the other fit over protruding studs.



FACOM® SATIN METRIC ANGLED OPEN-SOCKET WRENCHES - 12 POINT X 6 POINT

METRIC

| Product # | Size (mm) | Overall Length (in) | Weight (lbs) |
|-----------|-----------|---------------------|--------------|
| FM-76.6 | 6 | 4-1/64 | 0.07 |
| FM-76.7 | 7 | 4-11/64 | 0.09 |
| FM-76.8 | 8 | 4-31/64 | 0.13 |
| FM-76.9 | 9 | 4-51/64 | 0.14 |
| FM-76.10 | 10 | 5-5/64 | 0.21 |
| FM-76.11 | 11 | 5-23/64 | 0.25 |
| FM-76.12 | 12 | 5-43/64 | 0.34 |
| FM-76.13 | 13 | 5-63/64 | 0.39 |
| FM-76.14 | 14 | 6-19/64 | 0.44 |
| FM-76.15 | 15 | 6-21/32 | 0.50 |
| FM-76.16 | 16 | 7-1/64 | 0.63 |
| FM-76.17 | 17 | 7-23/64 | 0.69 |
| FM-76.18 | 18 | 7-43/64 | 0.80 |
| FM-76.19 | 19 | 8-1/32 | 0.95 |
| FM-76.20 | 20 | 8-11/32 | 0.97 |
| FM-76.21 | 21 | 8-45/64 | 1.08 |
| FM-76.22 | 22 | 9-1/16 | 1.18 |
| FM-76.23 | 23 | 9-29/64 | 1.38 |
| FM-76.24 | 24 | 9-27/32 | 1.46 |
| FM-76.25 | 25 | 10-15/64 | 1.73 |
| FM-76.26 | 26 | 10-5/8 | 1.75 |
| FM-76.27 | 27 | 11-1/32 | 2.09 |
| FM-76.28 | 28 | 11-27/64 | 2.09 |
| FM-76.29 | 29 | 11-13/16 | 2.31 |
| FM-76.30 | 30 | 12-13/64 | 2.87 |
| FM-76.31 | 31 | 12-19/32 | 3.05 |
| FM-76.32 | 32 | 12-63/64 | 3.09 |
| FM-76.33 | 33 | 13-25/64 | 3.26 |
| FM-76.34 | 34 | 13-25/32 | 3.42 |
| FM-76.35 | 35 | 14-11/64 | 3.59 |
| FM-76.36 | 36 | 14-9/16 | 3.75 |
| FM-76.38 | 38 | 15-23/64 | 4.59 |

- › Satin finish.
- › Angle and through-hole design helps accommodate threaded rods or a bar for extra leverage, without affecting wrench strength.
- › Deep recess at one end and open end socket at the other fit over protruding studs.





7 PIECE BOX WRENCH SET - 12 POINT

Product #: J1100R

- › Full polish finish provides corrosion resistance and easy to clean surfaces.
- › 12 point box end allows for fine indexing, helping to improve speed and access. Fits 4, 6 and 12 point fasteners.
- › Box ends incorporate the TorquePlus™ system.
- › Weight (lbs): 4.23



| Contents | Size (in) | Point Count | Overall Length (in) |
|----------|----------------|-------------|---------------------|
| J1170 | 5/16 x 3/8 | 12 | 6-15/16 |
| J1171 | 7/16 x 1/2 | 12 | 8-1/16 |
| J1172 | 9/16 x 5/8 | 12 | 9-7/16 |
| J1173 | 11/16 x 3/4 | 12 | 11-1/8 |
| J1174 | 13/16 x 7/8 | 12 | 13-1/8 |
| J1175 | 15/16 x 1 | 12 | 15-1/8 |
| J1176 | 1-1/16 x 1-1/8 | 12 | 17-1/2 |
| J25TR32C | Tool Roll | | |

ASME B107.100



5 PIECE BOX WRENCH SET - 12 POINT

Product #: J1100G

- › Full polish finish provides corrosion resistance and easy to clean surfaces.
- › 12 point box end allows for fine indexing, helping to improve speed and access. Fits 4, 6 and 12 point fasteners.
- › Box ends incorporate the TorquePlus™ system.
- › Weight (lbs): 2.20



| Contents | Size (in) | Point Count | Overall Length (in) |
|----------|-------------|-------------|---------------------|
| J1170 | 5/16 x 3/8 | 12 | 6-15/16 |
| J1171 | 7/16 x 1/2 | 12 | 8-1/16 |
| J1172 | 9/16 x 5/8 | 12 | 9-7/16 |
| J1173 | 11/16 x 3/4 | 12 | 11-1/8 |
| J1174 | 13/16 x 7/8 | 12 | 13-1/8 |
| J25TR04C | Tool Roll | | |

ASME B107.100



11 PIECE METRIC BOX WRENCH SET - 12 POINT**METRIC****Product #: J1100S-M**

- › Full polish finish provides corrosion resistance and easy to clean surfaces.
- › 12 point box end allows for fine indexing, helping to improve speed and access. Fits 4, 6 and 12 point fasteners.
- › Offset box end allows access to recessed fasteners and keeps hands clear of obstructions.
- › Box ends incorporate the TorquePlus™ system.
- › Weight (lbs): 7.40



| Contents | Size (mm) | Point Count | Overall Length (in) |
|----------|-----------|-------------|---------------------|
| J1050M | 6 x 7 | 12 | 5-49/64 |
| J1051M | 8 x 9 | 12 | 6-49/64 |
| J1053M | 10 x 11 | 12 | 7-31/32 |
| J1057M | 12 x 13 | 12 | 8-55/64 |
| J1061M | 14 x 15 | 12 | 9-45/64 |
| J1064M | 16 x 18 | 12 | 10-11/16 |
| J1065M | 17 x 19 | 12 | 11-23/64 |
| J1072M | 21 x 24 | 12 | 13-25/64 |
| J1073M | 22 x 24 | 12 | 13-45/64 |
| J1077M | 27 x 30 | 12 | 15-59/64 |
| J1079M | 30 x 32 | 12 | 17-13/64 |
| J25TR44C | Tool Roll | | |



ASME B107.100

**7 PIECE METRIC BOX WRENCH SET - 12 POINT****METRIC****Product #: J1100D-M**

- › Full polish finish provides corrosion resistance and easy to clean surfaces.
- › 12 point box end allows for fine indexing, helping to improve speed and access. Fits 4, 6 and 12 point fasteners.
- › Offset box end allows access to recessed fasteners and keeps hands clear of obstructions.
- › Box ends incorporate the TorquePlus™ system.
- › Weight (lbs): 2.04



| Contents | Size (mm) | Point Count | Overall Length (in) |
|----------|-----------|-------------|---------------------|
| J1050M | 6 x 7 | 12 | 5-49/64 |
| J1051M | 8 x 9 | 12 | 6-49/64 |
| J1053M | 10 x 11 | 12 | 7-31/32 |
| J1057M | 12 x 13 | 12 | 8-55/64 |
| J1061M | 14 x 15 | 12 | 9-45/64 |
| J1064M | 16 x 18 | 12 | 10-11/16 |
| J1065M | 17 x 19 | 12 | 11-23/64 |
| J25TR43C | Tool Roll | | |



ASME B107.100





7 PIECE OFFSET BOX WRENCH SET - 12 POINT

Product #: J1000G-500

- › Full polish finish provides corrosion resistance and easy to clean surfaces.
- › 12 point box end allows for fine indexing, helping to improve speed and access. Fits 4, 6 and 12 point fasteners.
- › Offset box end allows access to recessed fasteners and keeps hands clear of obstructions.
- › Box ends incorporate the TorquePlus™ system.
- › Weight (lbs): 3.84



| Contents | Size (in) | Point Count | Overall Length (in) |
|-----------|----------------|-------------|---------------------|
| J1012-500 | 3/8 x 7/16 | 12 | 7-3/4 |
| J1016-500 | 1/2 x 9/16 | 12 | 8-7/8 |
| J1018-500 | 9/16 x 5/8 | 12 | 9-1/2 |
| J1022-500 | 11/16 x 3/4 | 12 | 11-3/16 |
| J1026-500 | 13/16 x 7/8 | 12 | 12-11/16 |
| J1030-500 | 15/16 x 1 | 12 | 14-3/8 |
| J1034-500 | 1-1/16 x 1-1/8 | 12 | 16-3/4 |
| J25TR32C | Tool Roll | | |

 ASME B107.100



6 PIECE DEEP OFFSET BOX WRENCH SET - 12 POINT

Product #: J8100C

- › Satin finish provides corrosion resistance and a slip-resistant grip.
- › 12 point box end allows for fine indexing, helping to improve speed and access. Fits 4, 6 and 12 point fasteners.
- › 60° deep offset helps improve access to deeply recessed fasteners.
- › Offset handle helps keep knuckles clear of obstruction to help save time.
- › Box ends incorporate the TorquePlus™ system.
- › Weight (lbs): 3.33



| Contents | Size (in) | Point Count | Overall Length (in) |
|----------|---------------|-------------|---------------------|
| J8180 | 3/8 x 7/16 | 12 | 7-3/4 |
| J8181 | 1/2 x 9/16 | 12 | 9 |
| J8182 | 5/8 x 11/16 | 12 | 10-1/4 |
| J8183A | 11/16 x 13/16 | 12 | 11-1/2 |
| J8184 | 3/4 x 7/8 | 12 | 12-3/4 |
| J8185 | 15/16 x 1 | 12 | 14 |
| J25TR19C | Tool Roll | | |

 ASME B107.100



8 PIECE BLACK OXIDE BOX WRENCH SET - 12 POINT

Product #: **J1100MB**

- › Non-reflective black oxide finish for use where non-plated products are required.
- › 12 point box end allows for fine indexing, helping to improve speed and access. Fits 4, 6 and 12 point fasteners.
- › Box ends incorporate the TorquePlus™ system.
- › Weight (lbs): 5.39



| Contents | Size (in) | Point Count | Overall Length (in) |
|----------|----------------|-------------|---------------------|
| J1120LB | 5/16 x 3/8 | 12 | 6-15/16 |
| J1125LB | 7/16 x 1/2 | 12 | 8-1/16 |
| J1130LB | 9/16 x 5/8 | 12 | 9-7/16 |
| J1135B | 11/16 x 3/4 | 12 | 11-1/4 |
| J1140B | 13/16 x 7/8 | 12 | 13-7/8 |
| J1145B | 15/16 x 1 | 12 | 15-1/2 |
| J1150B | 1-1/16 x 1-1/8 | 12 | 17-1/4 |
| J1151B | 1-1/16 x 1-1/4 | 12 | 18-1/4 |
| J25TR27C | Tool Roll | | |



FACOM® 5 PIECE METRIC OBSTRUCTION BOX WRENCH SET



Product #: **FM-57.JE5**

- › Satin finish provides corrosion resistance and slip-resistant grip.
- › Half-moon shape helps improve access to hidden, difficult to reach locations.
- › 12 point box end allows for fine indexing, helping to improve speed and access.
- › Fits 4, 6 and 12 point fasteners.
- › Weight (lbs): 1.80

| Contents | Size (mm) | Point Count | Overall Length (in) |
|-------------|-----------|-------------|---------------------|
| FM-57.10X12 | 10 x 12 | 12 | 5-5/8 |
| FM-57.11X13 | 11 x 13 | 12 | 6-1/2 |
| FM-57.14X17 | 14 x 17 | 12 | 7-17/32 |
| FM-57.16X18 | 16 x 18 | 12 | 8-3/4 |
| FM-57.19X22 | 19 x 22 | 12 | 9-31/32 |



FULL POLISH DOUBLE BOX WRENCHES - 12 POINT

- › Full polish finish provides corrosion resistance and easy to clean surfaces.
- › 12 point box end allows for fine indexing, helping to improve speed and access. Fits 4, 6 and 12 point fasteners.
- › Box ends incorporate the TorquePlus™ system.



| Product # | Size (in) | Outside Head Width (in) (C) | Head Thickness (in) (D) | Outside Head Width (in) (C1) | Head Thickness (in) (D1) | Overall Length (in) | Weight (lbs) |
|-----------|----------------|-----------------------------|-------------------------|------------------------------|--------------------------|---------------------|--------------|
| J1170 | 5/16 x 3/8 | 37/64 | 17/64 | 15/32 | 15/64 | 6-15/16 | 0.20 |
| J1171 | 7/16 x 1/2 | 3/4 | 21/64 | 21/32 | 19/64 | 8-1/16 | 0.23 |
| J1126L | 1/2 x 9/16 | 7/8 | 3/8 | 3/4 | 23/64 | 8-3/8 | 0.24 |
| J1172 | 9/16 x 5/8 | 15/16 | 25/64 | 27/32 | 23/64 | 9-7/16 | 0.41 |
| J1173 | 11/16 x 3/4 | 17/64 | 29/64 | 11/64 | 27/64 | 11-1/8 | 0.53 |
| J1139 | 3/4 x 7/8 | 1-1/4 | 33/64 | 1-1/8 | 33/64 | 13-1/8 | 0.65 |
| J1174 | 13/16 x 7/8 | 1-19/64 | 33/64 | 1-3/16 | 31/64 | 13-1/8 | 0.65 |
| J1175 | 15/16 x 1 | 1-15/32 | 37/64 | 1-25/64 | 35/64 | 15-1/8 | 0.90 |
| J1176 | 1-1/16 x 1-1/8 | 1-37/64 | 5/8 | 1-1/2 | 19/32 | 17-1/2 | 1.54 |



AS954E S3.8.1

ASME B107.100

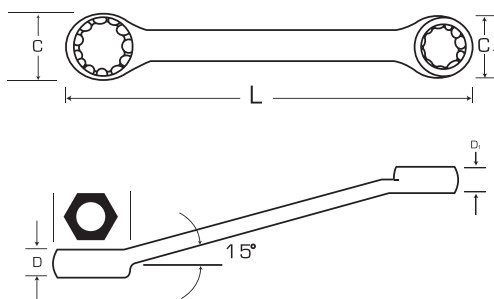

FACOM® FULL POLISH METRIC DOUBLE BOX WRENCHES - 12 POINT

- › Slim rings and short shank for clearance.
- › 12 point box ends allow for fine indexing, helping to improve speed and access.
- › Straight pattern.
- › Fits 4, 6 and 12 point fasteners.



| Product # | Size (mm) | Outside Head Width (in) (C) | Head Thickness (in) (D) | Outside Head Width (in) (C1) | Head Thickness (in) (D1) | Overall Length (in) | Weight (lbs) |
|-------------|-----------|-----------------------------|-------------------------|------------------------------|--------------------------|---------------------|--------------|
| FM-59.6X7 | 6 X 7 | 25/64 | 3/16 | 7/16 | 3/16 | 3-15/16 | 0.05 |
| FM-59.8X9 | 8 X 9 | 31/64 | 13/64 | 35/64 | 13/64 | 4-17/32 | 0.07 |
| FM-59.10X11 | 10 x 11 | 39/64 | 1/4 | 21/32 | 1/4 | 5-3/64 | 0.11 |
| FM-59.12X13 | 12 x 13 | 47/64 | 9/32 | 13/16 | 9/32 | 5-5/8 | 0.16 |
| FM-59.14X15 | 14 x 15 | 53/64 | 9/32 | 57/64 | 9/32 | 6-3/16 | 0.21 |
| FM-59.16X17 | 16 x 17 | 59/64 | 21/64 | 31/32 | 21/64 | 6-39/64 | 0.26 |
| FM-59.18X19 | 18 x 19 | 1-1/32 | 23/64 | 1-5/64 | 23/64 | 7-7/16 | 0.32 |
| FM-59.21X23 | 21 x 23 | 1-15/64 | 29/64 | 1-21/64 | 29/64 | 8-35/64 | 0.52 |
| FM-59.22X24 | 22 X 24 | 1-15/64 | 29/64 | 1-21/64 | 29/64 | 8-35/64 | 0.51 |
| FM-59.26X28 | 26 X 28 | 1-7/16 | 15/32 | 1-19/32 | 15/32 | 10-7/16 | 0.95 |
| FM-59.27X29 | 27 X 29 | 1-17/32 | 1/2 | 1-45/64 | 1/2 | 11-7/32 | 0.92 |
| FM-59.30X32 | 30 X 32 | 1-43/64 | 1/2 | 1-49/64 | 1/2 | 11-7/32 | 1.14 |



FULL POLISH DOUBLE BOX WRENCHES - SPLINE

- › Proto® Spline Tools are designed to service high tensile strength fasteners used widely on military and commercial aircraft and in heavy machinery applications where vibration is prevalent. They are also used in automotive and industrial areas where high performance torque needs to be achieved.
- › Spline fasteners help tighten high strength bolts to high torque loads.
- › They help lower the force required to turn standard fasteners by allowing the torque load to be moved away from the corners, helping prevent fastener rounding. They also turn fasteners with damaged corners.
- › Spline helps reduce foreign object debris (FOD) by having a precise fit between the fastening tool and its fastener.
- › Full polish finish provides corrosion resistance and an easy to clean surface.



| Product # | Size (in) | Outside Head Width (in) (C) | Head Thickness (in) (D) | Outside Head Width (in) (C1) | Head Thickness (in) (D1) | Overall Length (in) | Weight (lbs) |
|-----------|---------------|-----------------------------|-------------------------|------------------------------|--------------------------|---------------------|--------------|
| J1118SPL | 1/4 x 5/16 | 31/64 | 15/64 | 25/64 | 15/64 | 7-1/4 | 0.12 |
| J1122SPL | 3/8 x 7/16 | 43/64 | 23/64 | 37/64 | 21/64 | 8-1/4 | 0.18 |
| J1126SPL | 1/2 x 9/16 | 53/64 | 25/64 | 3/4 | 23/64 | 9-3/16 | 0.34 |
| J1130SPL | 9/16 x 5/8 | 59/64 | 29/64 | 53/64 | 25/64 | 9-3/4 | 0.4 |
| J1135SPL | 11/16 x 3/4 | 1-5/64 | 33/64 | 63/64 | 1/2 | 11 | 0.75 |
| J1142SPL | 13/16 x 15/16 | 1-23/64 | 37/64 | 1-5/32 | 17/32 | 12-3/4 | 1.03 |
| J1144SPL | 7/8 x 1 | 1-29/64 | 19/32 | 1-1/4 | 35/64 | 13-1/4 | 1.08 |



FEATURES AND BENEFITS — GRABBING ROUNDED HEADS

Spline End Wrenches are the better choice for working out a fastener with a rounded head. The tips of the spline always grab the fastener along the flat sides of the head, away from the damaged corners. You have a much better chance of getting a firmer grip that won't slip when you apply force.

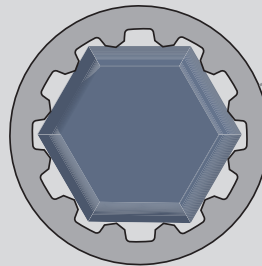

Spline tips grip away from the corners.

SATIN DOUBLE BOX WRENCHES - 12 POINT

- › Satin finish provides corrosion resistance and a slip-resistant grip.
- › 12 point box end allows for fine indexing, helping to improve speed and access. Fits 4, 6 and 12 point fasteners.
- › Box ends incorporate the TorquePlus™ system.



| Product # | Size (in) | Outside Head Width (in) (C) | Head Thickness (in) (D) | Outside Head Width (in) (C1) | Head Thickness (in) (D1) | Overall Length (in) | Weight (lbs) |
|-----------|-----------------|-----------------------------|-------------------------|------------------------------|--------------------------|---------------------|--------------|
| J1151 | 1-1/16 x 1-1/4 | 1-3/4 | 45/64 | 1-1/2 | 5/8 | 18-1/4 | 1.82 |
| J1155 | 1-1/4 x 1-5/16 | 1-7/8 | 47/64 | 1-3/4 | 3/4 | 19-1/4 | 1.97 |
| J1160 | 1-1/4 x 1-3/8 | 1-15/16 | 3/4 | 1-3/4 | 3/4 | 20-1/4 | 2.22 |
| J1162 | 1-7/16 x 1-1/2 | 2-1/8 | 13/16 | 2-3/64 | 51/64 | 22-1/4 | 2.98 |
| J1164 | 1-5/8 x 1-11/16 | 2-3/8 | 29/32 | 2-13/32 | 29/32 | 24-1/2 | 3.74 |



AS954E S3.8.1

ASME B107.100



BLACK OXIDE DOUBLE BOX WRENCHES - 12 POINT

- › Non-reflective black oxide finish for use where non-plated products are required.
- › 12 point box end allows for fine indexing, helping to improve speed and access. Fits 4, 6 and 12 point fasteners.
- › Box ends incorporate the TorquePlus™ system.



| Product # | Size (in) | Outside Head Width (in) (C) | Head Thickness (in) (D) | Outside Head Width (in) (C1) | Head Thickness (in) (D1) | Overall Length (in) | Weight (lbs) |
|-----------|----------------|-----------------------------|-------------------------|------------------------------|--------------------------|---------------------|--------------|
| J1120LB | 5/16 x 3/8 | 37/64 | 17/64 | 15/32 | 15/64 | 6-15/16 | 0.15 |
| J1125LB | 7/16 x 1/2 | 3/4 | 21/64 | 21/32 | 19/64 | 8-1/16 | 0.18 |
| J1126LB | 1/2 x 9/16 | 57/64 | 25/64 | 13/16 | 3/8 | 8-7/16 | 0.24 |
| J1130LB | 9/16 x 5/8 | 15/16 | 25/64 | 27/32 | 23/64 | 9-7/16 | 0.28 |
| J1135B | 11/16 x 3/4 | 1-7/64 | 29/64 | 1-1/64 | 27/64 | 11-1/4 | 0.48 |
| J1139B | 3/4 x 7/8 | 1-1/4 | 33/64 | 1-1/8 | 33/64 | 13-1/8 | 0.65 |
| J1140B | 13/16 x 7/8 | 1-19/64 | 33/64 | 1-3/16 | 31/64 | 13-7/8 | 0.69 |
| J1145B | 15/16 x 1 | 1-29/64 | 37/64 | 1-3/8 | 35/64 | 15-1/2 | 0.99 |
| J1150B | 1-1/16 x 1-1/8 | 1-39/64 | 5/8 | 1-1/2 | 19/32 | 17-1/4 | 1.50 |
| J1151B | 1-1/16 x 1-1/4 | 1-3/4 | 39/64 | 1-1/2 | 45/64 | 18-1/4 | 1.82 |



AS954E S3.8.1

FULL POLISH OFFSET BOX WRENCHES - 12 POINT

- › Full polish finish provides corrosion resistance and easy to clean surfaces.
- › 12 point box end allows for fine indexing, helping to improve speed and access. Fits 4, 6 and 12 point fasteners.
- › Offset box end allows access to recessed fasteners and keeps hands clear of obstructions.
- › Box ends incorporate the TorquePlus™ system.



| Product # | Size (in) | Outside Head Width (in) (C) | Head Thickness (in) (D) | Outside Head Width (in) (C1) | Head Thickness (in) (D1) | Overall Length (in) | Weight (lbs) |
|-----------|----------------|-----------------------------|-------------------------|------------------------------|--------------------------|---------------------|--------------|
| J1012-500 | 3/8 x 7/16 | 21/32 | 5/16 | 37/64 | 19/64 | 7-3/4 | 0.11 |
| J1016-500 | 1/2 x 9/16 | 53/64 | 23/64 | 3/4 | 11/32 | 8-7/8 | 0.20 |
| J1018-500 | 9/16 x 5/8 | 59/64 | 13/32 | 53/64 | 23/64 | 9-1/2 | 0.27 |
| J1022-500 | 11/16 x 3/4 | 1-3/32 | 15/32 | 1-1/64 | 29/64 | 11-3/16 | 0.40 |
| J1026-500 | 13/16 x 7/8 | 1-1/4 | 33/64 | 1-11/64 | 31/64 | 12-11/16 | 0.67 |
| J1030-500 | 15/16 x 1 | 1-13/32 | 37/64 | 1-21/64 | 35/64 | 14-3/8 | 0.88 |
| J1034-500 | 1-1/16 x 1-1/8 | 1-9/16 | 41/64 | 1-31/64 | 41/64 | 16-3/4 | 1.15 |



AS954E S3.8.1

ASME B107.100

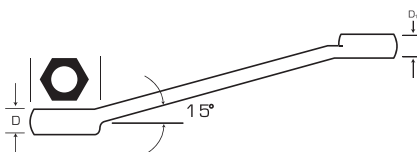
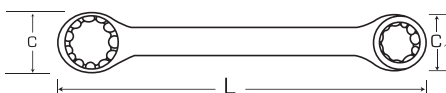

FULL POLISH METRIC OFFSET BOX WRENCHES - 12 POINT



- › Full polish finish provides corrosion resistance and easy to clean surfaces.
- › 12 point box end allows for fine indexing, helping to improve speed and access. Fits 4, 6 and 12 point fasteners.
- › Offset box end allows access to recessed fasteners and keeps hands clear of obstructions.
- › Box ends incorporate the TorquePlus™ system.



| Product # | Size (mm) | Outside Head Width (in) (C) | Outside Head Width (in) (C1) | Overall Length (in) | Weight (lbs) |
|-----------|-----------|-----------------------------|------------------------------|---------------------|--------------|
| J1050M | 6 x 7 | 29/64 | 13/32 | 5-49/64 | 0.09 |
| J1051M | 8 x 9 | 35/64 | 31/64 | 6-49/64 | 0.11 |
| J1053M | 10 x 11 | 21/32 | 39/64 | 7-31/32 | 0.19 |
| J1057M | 12 x 13 | 3/4 | 45/64 | 8-55/64 | 0.28 |
| J1058M | 12 x 14 | 13/16 | 45/64 | 9-1/16 | 0.42 |
| J1061M | 14 x 15 | 7/8 | 13/16 | 9-45/64 | 0.39 |
| J1064M | 16 x 18 | 1-1/32 | 29/32 | 10-11/16 | 0.45 |
| J1065M | 17 x 19 | 1-5/64 | 63/64 | 11-23/64 | 0.59 |
| J1068M | 19 x 21 | 1-3/16 | 1-5/64 | 12-15/32 | 0.70 |
| J1069M | 19 x 22 | 1-17/64 | 1-5/64 | 12-15/32 | 0.70 |
| J1072M | 21 x 24 | 1-11/32 | 1-3/16 | 13-25/64 | 0.99 |
| J1073M | 22 x 24 | 1-11/32 | 1-17/64 | 13-45/64 | 0.94 |
| J1077M | 27 x 30 | 1-43/64 | 1-33/64 | 15-59/64 | 1.42 |
| J1079M | 30 x 32 | 1-25/32 | 1-43/64 | 17-13/64 | 1.76 |



AS954E S3.8.1

ASME B107.100

SATIN DEEP OFFSET BOX WRENCHES - 12 POINT

- › Satin finish provides corrosion resistance and a slip-resistant grip.
- › 12 point box end allows for fine indexing, helping to improve speed and access. Fits 4, 6 and 12 point fasteners.
- › 60° deep offset helps improve access to deeply recessed fasteners.
- › Offset handle helps keep knuckles clear of obstruction to help save time.
- › Box ends incorporate the TorquePlus™ system.



| Product # | Size (in) | Outside Head Width (in) (C) | Head Thickness (in) (D) | Outside Head Width (in) (C1) | Head Thickness (in) (D1) | Overall Length (in) | Weight (lbs) |
|-----------|---------------|-----------------------------|-------------------------|------------------------------|--------------------------|---------------------|--------------|
| J8180 | 3/8 x 7/16 | 39/64 | 5/16 | 45/64 | 11/32 | 7-3/4 | 0.19 |
| J8181 | 1/2 x 9/16 | 51/64 | 23/64 | 57/64 | 23/64 | 9 | 0.32 |
| J8182 | 5/8 x 11/16 | 31/32 | 13/32 | 1-1/32 | 7/16 | 10-1/4 | 0.44 |
| J8183A | 11/16 x 13/16 | 1-3/16 | 1/2 | 1-1/4 | 1/2 | 11-1/2 | 0.54 |
| J8184 | 3/4 x 7/8 | 1-1/8 | 1/2 | 1-1/4 | 17/32 | 12-3/4 | 0.74 |
| J8185 | 15/16 x 1 | 1-11/32 | 5/8 | 1-13/32 | 5/8 | 14 | 1.10 |



AS954E S3.8.1

ASME B107.100

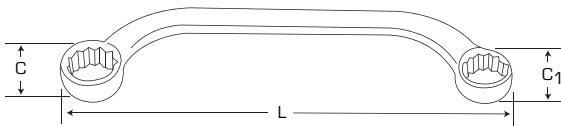

SHORT SATIN DOUBLE BOX WRENCHES - 12 POINT

- › Satin finish provides corrosion resistance and a slip-resistant grip.
- › 12 point box end allows for fine indexing, helping to improve speed and access. Fits 4, 6 and 12 point fasteners.
- › Box ends incorporate the TorquePlus™ system.



| Product # | Size (in) | Outside Head Width (in) (C) | Head Thickness (in) (D) | Outside Head Width (in) (C1) | Head Thickness (in) (D1) | Overall Length (in) | Weight (lbs) |
|-----------|------------|-----------------------------|-------------------------|------------------------------|--------------------------|---------------------|--------------|
| J1120 | 5/16 x 3/8 | 33/64 | 17/64 | 37/64 | 19/64 | 4-1/4 | 0.07 |
| J1122 | 3/8 x 7/16 | 37/64 | 19/64 | 43/64 | 21/64 | 4-5/8 | 0.09 |
| J1125 | 7/16 x 1/2 | 43/64 | 21/64 | 49/64 | 11/32 | 5 | 0.10 |
| J1126 | 1/2 x 9/16 | 43/64 | 11/32 | 55/64 | 23/64 | 5-3/8 | 0.12 |
| J1131 | 5/8 x 3/4 | 1-27/32 | 13/32 | 1-3/32 | 15/32 | 6-1/8 | 0.25 |



AS954E S3.8.1

ASME B107.100

SATIN OBSTRUCTION BOX WRENCHES - 12 POINT

- › Satin chrome finish provides corrosion resistance and a slip-resistant grip.
- › Made of forged steel then heat-treated.
- › Curved half-moon shape helps improve access to hidden, difficult to reach locations.
- › 12 point box end allows for fine indexing, helping to improve speed and access. Fits 4, 6 and 12 point fasteners.
- › Box ends incorporate the TorquePlus™ system.



| Product # | Size (in) | Outside Head Width (in) (C) | Outside Head Width (in) (C1) | Overall Length (in) | Weight (lbs) |
|-----------|------------|-----------------------------|------------------------------|---------------------|--------------|
| J1725 | 7/16 x 1/2 | 5/8 | 5/8 | 5-3/4 | 0.17 |
| J1730 | 9/16 x 5/8 | 25/32 | 25/32 | 6-5/8 | 0.23 |
| J1731 | 5/8 x 3/4 | 27/32 | 27/32 | 7-1/4 | 0.39 |



AS954E S3.8.1

ASME B107.100

FACOM® SATIN METRIC OBSTRUCTION BOX WRENCHES - 12 POINT

- › Satin finish provides corrosion resistance and a slip-resistant grip.
- › Half-moon shape helps improve access to hidden, difficult to reach locations.
- › 12 point box end allows for fine indexing, helping to improve speed and access.
- › Fits 4, 6 and 12 point fasteners.



| Product # | Size (mm) | Outside Head Width (in) (C) | Head Thickness (in) (D) | Outside Head Width (in) (C1) | Head Thickness (in) (D1) | Overall Length (in) | Weight (lbs) |
|-------------|-----------|-----------------------------|-------------------------|------------------------------|--------------------------|---------------------|--------------|
| FM-57.10X12 | 10 x 12 | 43/64 | 5/16 | 49/64 | 5/16 | 5-5/8 | 0.15 |
| FM-57.11X13 | 11 x 13 | 43/64 | 5/16 | 49/64 | 5/16 | 6-1/2 | 0.24 |
| FM-57.13X15 | 13 x 15 | 25/32 | 21/64 | 29/32 | 23/64 | 7-15/32 | 0.35 |
| FM-57.14X16 | 14 x 16 | 57/64 | 23/64 | 31/32 | 3/8 | 7-7/16 | 0.35 |
| FM-57.14X17 | 14 x 17 | 57/64 | 23/64 | 31/32 | 3/8 | 7-17/32 | 0.34 |
| FM-57.15X17 | 15 x 17 | 57/64 | 23/64 | 31/32 | 3/8 | 8-3/4 | 0.46 |
| FM-57.16X18 | 16 x 18 | 15/16 | 3/8 | 1-1/16 | 25/64 | 8-3/4 | 0.45 |
| FM-57.19X22 | 19 x 22 | 1-1/8 | 25/64 | 1-9/32 | 7/16 | 9-31/32 | 0.62 |

FACOM® INSULATED BOX WRENCHES - 12 POINT



- › Insulated to 1000V or 1500 DC.
- › 2 color warning handle insulation - color changes from orange to yellow if insulation integrity compromised.
- › 12 point box end allows for fine indexing, helping to improve speed and access.
- › Fits 4, 6 and 12 point fasteners.



| Product # | Size (mm) | Outside Head Width (in) (C) | Head Thickness (in) (D) | Offset Height (in) (E) | Overall Length (in) | Weight (lbs) |
|--------------|-----------|-----------------------------|-------------------------|------------------------|---------------------|--------------|
| FM-55.8AVSE | 8 | 5/8 | 5/16 | 5/8 | 6-1/32 | 0.12 |
| FM-55.9AVSE | 9 | 43/64 | 23/64 | 43/64 | 6-1/2 | 0.13 |
| FM-55.10AVSE | 10 | 3/4 | 23/64 | 43/64 | 6-5/16 | 0.12 |
| FM-55.11AVSE | 11 | 25/32 | 25/64 | 3/4 | 6-11/16 | 0.15 |
| FM-55.12AVSE | 12 | 53/64 | 7/16 | 25/32 | 6-7/8 | 0.23 |
| FM-55.13AVSE | 13 | 29/32 | 15/32 | 25/32 | 7-3/32 | 0.22 |
| FM-55.14AVSE | 14 | 63/64 | 15/32 | 53/64 | 7-15/32 | 0.27 |
| FM-55.15AVSE | 15 | 1-1/32 | 15/32 | 53/64 | 7-11/16 | 0.29 |
| FM-55.16AVSE | 16 | 1-1/16 | 33/64 | 1-1/32 | 8-1/16 | 0.34 |
| FM-55.17AVSE | 17 | 1-3/16 | 35/64 | 1-1/16 | 7-7/8 | 0.34 |
| FM-55.18AVSE | 18 | 1-3/16 | 35/64 | 1-1/16 | 8-7/8 | 0.46 |
| FM-55.19AVSE | 19 | 1-17/64 | 35/64 | 1-1/16 | 9-1/4 | 0.49 |
| FM-55.21AVSE | 21 | 1-3/8 | 5/8 | 1-7/32 | 10-1/32 | 0.75 |

10 PIECE OPEN END WRENCH SET

Product #: J3000H

| Contents | Size (in) | Overall Length (in) |
|----------|----------------|---------------------|
| J3018 | 1/4 x 5/16 | 4-31/64 |
| J3020 | 5/16 x 3/8 | 5-1/8 |
| J3025 | 7/16 x 1/2 | 6-3/8 |
| J3026 | 1/2 x 9/16 | 7 |
| J3030 | 9/16 x 5/8 | 7-5/8 |
| J3031 | 5/8 x 3/4 | 8-9/16 |
| J3035 | 11/16 x 3/4 | 8-7/8 |
| J3040 | 13/16 x 7/8 | 10-1/8 |
| J3045 | 15/16 x 1 | 11-1/2 |
| J3050 | 1-1/16 x 1-1/8 | 12-5/8 |
| J25TR05C | Tool Roll | |

ASME B107.100

- › Satin finish provides corrosion resistance and a slip-resistant grip.
- › 15° angle heads.
- › Special heat-treated alloy steel permits slim shanks for strength and durability.
- › Standard open end configuration.
- › Weight (lbs): 4.82



10 PIECE BLACK OXIDE OPEN END WRENCH SET

Product #: J3000HB

| Contents | Size (in) | Overall Length (in) |
|----------|----------------|---------------------|
| J3020B | 5/16 x 3/8 | 5-1/4 |
| J3025B | 7/16 x 1/2 | 6-7/16 |
| J3030B | 9/16 x 5/8 | 7-47/64 |
| J3035B | 11/16 x 3/4 | 8-63/64 |
| J3040B | 13/16 x 7/8 | 10-15/64 |
| J3045B | 15/16 x 1 | 11-31/64 |
| J3050B | 1-1/16 x 1-1/8 | 12-3/8 |
| J3055B | 1-1/4 x 1-5/16 | 14-5/8 |
| J3060B | 1-3/8 x 1-7/16 | 15-7/8 |
| J3070B | 1-1/2 x 1-5/8 | 17-1/16 |
| J25TR05C | Tool Roll | |

- › Non-reflective black oxide finish for use where non-plated products are required.
- › 15° angle heads.
- › Special heat-treated alloy steel permits slim shanks for strength and durability.
- › Standard open-end configuration.
- › Weight (lbs): 12.62



10 PIECE METRIC OPEN END WRENCH SET

METRIC

Product #: J30000A

| Contents | Size (mm) | Overall Length (in) |
|----------|-----------|---------------------|
| J30607 | 6 x 7 | 4-1/2 |
| J30809 | 8 x 9 | 5-1/8 |
| J31011 | 10 x 11 | 5-3/4 |
| J31213 | 12 x 13 | 6-3/8 |
| J31415 | 14 x 15 | 7-19/32 |
| J31617 | 16 x 17 | 8-15/64 |
| J31819 | 18 x 19 | 8-55/64 |
| J32022 | 20 x 22 | 9-31/64 |
| J32123 | 21 x 23 | 10-1/8 |
| J32426 | 24 x 26 | 11-3/8 |
| J25TR28C | Tool Roll | |



ASME B107.100

- › Satin finish provides corrosion resistance and a slip-resistant grip.
- › 15° angle heads.
- › Special heat-treated alloy steel permits slim shanks for strength and durability.
- › Standard open end configuration.
- › Weight (lbs): 3.93



6 PIECE METRIC OPEN END WRENCH SET

METRIC

Product #: J30000R

- › Satin finish provides corrosion resistance and a slip-resistant grip.
- › 15° angle heads.
- › Special heat-treated alloy steel permits slim shanks for strength and durability.
- › Standard open end configuration.
- › Weight (lbs): 1.63

| Contents | Size (mm) | Overall Length (in) |
|----------|-----------|---------------------|
| J30809 | 8 x 9 | 5-1/8 |
| J31011 | 10 x 11 | 5-3/4 |
| J31213 | 12 x 13 | 6-3/8 |
| J31415 | 14 x 15 | 7-19/32 |
| J31617 | 16 x 17 | 8-15/64 |
| J31819 | 18 x 19 | 8-55/64 |
| J25TR25C | Tool Roll | |



ASME B107.100



5 PIECE OPEN END WRENCH SET

Product #: J3000N

- › Satin finish.
- › 15° angle heads.
- › Special heat-treated alloy steel permits slim shanks for strength and durability.
- › Standard open end configuration.
- › Weight (lbs): 1.66

| Contents | Size (in) | Overall Length (in) |
|----------|-------------|---------------------|
| J3021 | 3/8 x 7/16 | 5-3/4 |
| J3026 | 1/2 x 9/16 | 7 |
| J3030 | 9/16 x 5/8 | 7-5/8 |
| J3035 | 11/16 x 3/4 | 8-7/8 |
| J3040 | 13/16 x 7/8 | 10-1/8 |
| J25TR06C | Tool Roll | |



ASME B107.100



5 PIECE METRIC OPEN END WRENCH SET

METRIC

Product #: **J3000P-M**

- › Special heat-treated alloy steel permits slim shanks for strength and durability.
- › 15° angled heads.
- › Standard open end configuration.
- › Weight (lbs): 1.92

| Contents | Size (mm) | Overall Length (in) |
|----------|-----------|---------------------|
| J31011 | 10 x 11 | 5-3/4 |
| J31213 | 12 x 13 | 6-3/8 |
| J31415 | 14 x 15 | 7-19/32 |
| J31819 | 18 x 19 | 8-55/64 |
| J32123 | 21 x 23 | 10-1/8 |
| J25TR06C | Tool Roll | |



ASME B107.100



SATIN OPEN END WRENCHES

- › Satin finish provides corrosion resistance and a slip-resistant grip.
- › 15° angle heads.
- › Special heat-treated alloy steel permits slim shanks for strength and durability.
- › Standard open end configuration.



| Product # | Size (in) | Throat Depth (in) (B) | Outside Head Width (in) (C) | Head Thickness (in) (D) | Throat Depth (in) (B1) | Outside Head Width (in) (C1) | Head Thickness (in) (D1) | Overall Length (in) | Weight (lbs) |
|--------------|-------------------|-----------------------|-----------------------------|-------------------------|------------------------|------------------------------|--------------------------|---------------------|--------------|
| J3016 | 3/16 x 1/4 | 17/64 | 1/2 | 5/32 | 1/4 | 7/16 | 5/32 | 3-7/8 | 0.04 |
| J3018 | 1/4 x 5/16 | 3/8 | 21/32 | 3/16 | 19/64 | 35/64 | 5/32 | 4-31/64 | 0.07 |
| J3020 | 5/16 x 3/8 | 7/16 | 25/32 | 13/64 | 3/8 | 41/64 | 13/64 | 5-1/8 | 0.09 |
| J3021 | 3/8 x 7/16 | 23/64 | 29/32 | 7/22 | 7/16 | 25/32 | 7/32 | 5-3/4 | 0.12 |
| J3025 | 7/16 x 1/2 | 19/32 | 1-1/32 | 1/4 | 29/32 | 29/32 | 1/4 | 6-3/8 | 0.19 |
| J3026 | 1/2 x 9/16 | 43/64 | 1-3/16 | 17/64 | 19/32 | 1-1/32 | 17/64 | 7 | 0.23 |
| J3030 | 9/16 x 5/8 | 3/4 | 1-17/64 | 9/32 | 11/16 | 1-5/32 | 9/32 | 7-5/8 | 0.28 |
| J3031 | 5/8 x 3/4 | 29/32 | 1-37/64 | 5/16 | 47/64 | 1-5/32 | 5/16 | 8-9/16 | 0.39 |
| J3034 | 5/8 x 11/16 | 53/64 | 1-13/32" | 5/16 | 3/4 | 1-9/32 | 5/16 | 8-1/4 | 0.35 |
| J3035 | 11/16 x 3/4 | 29/32 | 1-37/64 | 21/64 | 53/64 | 1-13/32 | 21/64 | 8-7/8 | 0.47 |
| J3037 | 11/16 x 25/32 | 57/64 | 1-37/64 | 21/64 | 53/64 | 1-13/32 | 21/64 | 8-7/8 | 0.46 |
| J3039 | 3/4 x 7/8 | 1-1/16 | 1-25/32 | 11/32 | 29/32 | 1-37/64 | 11/32 | 9-1/2 | 0.6 |
| J3040 | 13/16 x 7/8 | 1-3/64 | 1-25/32 | 23/64 | 63/64 | 1-21/32 | 23/64 | 10-1/8 | 0.62 |
| J3045 | 15/16 x 1 | 1-13/64 | 2-1/64 | 13/32 | 1-1/8 | 1-29/32 | 13/32 | 11-1/2 | 0.92 |
| J3050 | 1-1/16 x 1-1/8 | 1-23/64 | 2-17/64 | 29/64 | 1-9/32 | 2-5/32 | 29/64 | 12-5/8 | 1.24 |
| J3051 | 1-1/16 x 1-1/4 | 1-31/64 | 2-33/64 | 15/32 | 1-9/32 | 2-5/32 | 15/32 | 13-9/16 | 1.47 |
| J3055 | 1-1/4 x 1-5/16 | 1-9/16 | 2-21/32 | 33/64 | 1-31/64 | 2-33/64 | 33/64 | 14-1/2 | 1.87 |
| J3060 | 1-3/8 x 1-7/16 | 1-23/32 | 2-57/64 | 35/64 | 1-41/64 | 2-23/32 | 35/64 | 15-3/4 | 2.59 |
| J3070 | 1-1/2 x 1-5/8 | 1-15/16 | 3-17/64 | 39/64 | 1-25/32 | 2-61/64 | 39/64 | 17 | 3.31 |
| J3075 | 1-11/16 x 1-13/16 | 2-3/16 | 3-41/64 | 45/64 | 2 | 3-25/64 | 45/64 | 18-1/2 | 4.71 |
| J3080 | 1-7/8 x 2 | 2-3/8 | 4-1/32 | 49/64 | 2-11/64 | 3-41/64 | 45/64 | 20 | 6.38 |



ASME B107.100



SATIN METRIC OPEN END WRENCHES

METRIC

- › Satin finish provides corrosion resistance and a slip-resistant grip.
- › 15° angle heads.
- › Special heat-treated alloy steel permits slim shanks for strength and durability.
- › Standard open end configuration.



| Product # | Size (mm) | Throat Depth (in) (B) | Outside Head Width (in) (C) | Head Thickness (in) (D) | Throat Depth (in) (B1) | Outside Head Width (in) (C1) | Head Thickness (in) (D1) | Overall Length (in) | Weight (lbs) |
|-----------|-----------|-----------------------|-----------------------------|-------------------------|------------------------|------------------------------|--------------------------|---------------------|--------------|
| J30607 | 6 x 7 | 3/8 | 41/64 | 11/64 | 19/64 | 1/2 | 11/64 | 4-1/2 | 0.06 |
| J30809 | 8 x 9 | 7/16 | 25/32 | 3/16 | 3/8 | 21/32 | 3/16 | 5-1/8 | 0.09 |
| J31011 | 10 x 11 | 17/32 | 29/32 | 7/32 | 29/64 | 25/32 | 7/32 | 5-3/4 | 0.13 |
| J31213 | 12 x 13 | 19/32 | 1-1/32 | 1/4 | 17/32 | 29/32 | 1/4 | 6-3/8 | 0.17 |
| J31415 | 14 x 15 | 3/4 | 1-9/32 | 9/32 | 11/16 | 1-9/64 | 9/32 | 7-19/32 | 0.3 |
| J31617 | 16 x 17 | 57/64 | 1-13/32 | 19/64 | 3/4 | 1-9/32 | 19/64 | 8-15/64 | 0.33 |
| J31819 | 18 x 19 | 29/32 | 1-37/64 | 21/64 | 53/64 | 1-13/32 | 21/64 | 8-55/64 | 0.48 |
| J32022 | 20 x 22 | 1-3/64 | 1-13/16 | 11/32 | 29/32 | 1-37/64 | 11/32 | 9-31/64 | 0.58 |
| J32123 | 21 x 23 | 1-3/64 | 1-25/32 | 23/64 | 63/64 | 1-21/32 | 23/64 | 10-1/8 | 0.61 |
| J32426 | 24 x 26 | 1-13/64 | 2-1/64 | 13/32 | 1-1/8 | 1-29/32 | 13/32 | 11-3/8 | 0.88 |



ASME B107.100

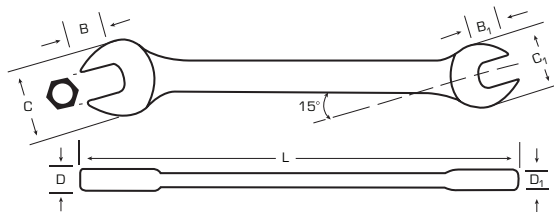

BLACK OXIDE OPEN END WRENCHES

- › Non-reflective black oxide finish for use where non-plated products are required.
- › 15° angle heads.
- › Special heat-treated alloy steel permits slim shanks for strength and durability.
- › Standard open end configuration.



| Product # | Size (in) | Throat Depth (in) (B) | Outside Head Width (in) (C) | Head Thickness (in) (D) | Throat Depth (in) (B1) | Outside Head Width (in) (C1) | Head Thickness (in) (D1) | Overall Length (in) | Weight (lbs) |
|-----------|-----------------|-----------------------|-----------------------------|-------------------------|------------------------|------------------------------|--------------------------|---------------------|--------------|
| J3020B | 5/16 x 3/8 | 7/16 | 25/32 | 3/16 | 7/32 | 21/32 | 3/16 | 5-1/4 | 0.08 |
| J3021B | 3/8 x 7/16 | 33/64 | 29/32 | 7/32 | 29/64 | 25/32 | 7/32 | 5-7/8 | 0.12 |
| J3025B | 7/16 x 1/2 | 39/64 | 1-1/32 | 15/64 | 35/64 | 29/32 | 15/64 | 6-7/16 | 0.16 |
| J3026B | 1/2 x 9/16 | 11/16 | 1-3/16 | 1/4 | 19/32 | 1-1/32 | 1/4 | 7-7/64 | 0.22 |
| J3030B | 9/16 x 5/8 | 3/4 | 1-9/32 | 17/64 | 1-1/16 | 1-5/32 | 17/64 | 7-47/64 | 0.28 |
| J3031B | 5/8 x 3/4 | 29/32 | 1-37/64 | 19/64 | 3/4 | 1-5/32 | 19/64 | 8-43/64 | 0.38 |
| J3035B | 11/16 x 3/4 | 29/32 | 1-37/64 | 5/16 | 13/16 | 1-13/32 | 5/16 | 8-63/64 | 0.44 |
| J3039B | 3/4 x 7/8 | 1-3/64 | 1-17/64 | 21/64 | 29/32 | 1-37/64 | 21/64 | 9-39/64 | 0.50 |
| J3040B | 13/16 x 7/8 | 1-3/64 | 1-25/32 | 23/64 | 61/64 | 1-31/32 | 23/64 | 10-15/64 | 0.61 |
| J3045B | 15/16 x 1 | 1-13/64 | 2-1/64 | 31/64 | 1-1/8 | 1-29/32 | 31/64 | 11-31/64 | 0.88 |
| J3050B | 1-1/16 x 1-1/8 | 1-23/64 | 2-17/64 | 7/16 | 1-15/64 | 2-9/64 | 7/16 | 12-3/8 | 1.20 |
| J3051B | 1-1/16 x 1- 1/4 | 1-1/2 | 2-33/64 | 29/64 | 1-9/32 | 2-9/64 | 29/64 | 13-43/64 | 1.47 |
| J3055B | 1-1/4 x 1-5/16 | 1-37/64 | 2-41/64 | 1/2 | 1-1/2 | 2-33/64 | 1/2 | 14-5/8 | 1.87 |
| J3060B | 1-3/8 x 1-7/16 | 1-47/64 | 2-57/64 | 17/32 | 1-21/32 | 2-23/32 | 17/32 | 15-7/8 | 2.48 |
| J3070B | 1-1/2 x 1-5/8 | 1-61/64 | 3-1/64 | 39/64 | 1-51/64 | 2-61/64 | 39/64 | 17-1/16 | 3.07 |



EXTRA THIN SATIN OPEN END WRENCHES

- › Satin finish provides corrosion resistance and a slip-resistant grip.
- › Ultra-thin profile and long handle produce improved access to hard-to-reach fasteners.
- › Use when high leverage or distance from a hot assembly is required.
- › Opening is designed to cover tappets, screws and lock nuts without excessive overhang which improves access.



| Product # | Size (in) | Throat Depth (in) (B) | Outside Head Width (in) (C) | Head Thickness (in) (D) | Throat Depth (in) (B1) | Outside Head Width (in) (C1) | Head Thickness (in) (D1) | Overall Length (in) | Weight (lbs) |
|-----------|-------------|-----------------------|-----------------------------|-------------------------|------------------------|------------------------------|--------------------------|---------------------|--------------|
| J3425 | 7/16 x 1/2 | 19/32 | 1-3/32 | 11/64 | 33/64 | 1-1/64 | 11/64 | 10 | 0.16 |
| J3426 | 1/2 x 9/16 | 43/64 | 1-13/64 | 11/64 | 19/32 | 1-9/64 | 11/64 | 10 | 0.16 |
| J3430 | 9/16 x 5/8 | 47/64 | 1-21/64 | 11/64 | 43/64 | 1-1/4 | 11/64 | 10 | 0.21 |
| J3435 | 11/16 x 3/4 | 57/64 | 1-7/16 | 13/64 | 13/16 | 1-11/32 | 13/64 | 10 | 0.26 |
| J3440 | 13/16 x 7/8 | 1-1/32 | 1-49/64 | 13/64 | 31/32 | 1-11/16 | 13/64 | 10 | 0.33 |



FACOM® 5 PIECE SHORT OPEN END WRENCH SET



Product #: **FF-22.JU5T**

- › Short shank and slim heads for access in confined spaces.
- › Weight (lbs): 0.22

| Contents | Size (in) | Overall Length (in) |
|------------------|--------------|---------------------|
| FF-22.1/2X9/16 | 1/2 x 9/16 | 4-11/32 |
| FF-22.11/32X7/16 | 11/32 x 7/16 | 3-15/16 |
| FF-22.3/16X1/4 | 3/16 x 1/4 | 3-11/32 |
| FF-22.5/16X3/8 | 5/16 x 3/8 | 3-17/32 |
| FF-22.7/32X9/32 | 7/32 x 9/32 | 3-11/32 |



FACOM® 6 PIECE METRIC SHORT OPEN END WRENCH SET



Product #: **FM-22.JE6T**

- › Short shank and slim heads for access in confined spaces.
- › Weight (lbs): 0.23

| Contents | Size (mm) | Overall Length (in) |
|---------------|-----------|---------------------|
| FM-22.3.2X5.5 | 3.2 x 5.5 | 2-9/32 |
| FM-22.4X5 | 4 x 5 | 2-9/32 |
| FM-22.6X7 | 6 x 7 | 3-5/16 |
| FM-22.8X9 | 8 x 9 | 3-1/2 |
| FM-22.10X11 | 10 x 11 | 3-7/8 |
| FM-22.12X13 | 12 x 13 | 4-5/16 |



FACOM® SHORT SATIN OPEN END WRENCHES



- › Satin finish provides corrosion resistance and a slip-resistant grip.
- › Short shank and slim heads for access in confined spaces.
- › Standard open end configuration.



| Product # | Size (in) | Outside Head Width (in) (C) | Head Thickness (in) (D) | Outside Head Width (in) (C1) | Head Thickness (in) (D1) | Overall Length (in) | Weight (lbs) |
|-------------------------|--------------|-----------------------------|-------------------------|------------------------------|--------------------------|---------------------|--------------|
| FF-22.3/16X1/4 | 3/16 x 1/4 | 35/64 | 1/8 | 5/8 | 1/8 | 3-11/32 | 0.03 |
| FF-22.7/32X9/32 | 7/32 x 9/32 | 35/64 | 1/8 | 5/8 | 1/8 | 3-11/32 | 0.03 |
| FF-22.5/16X3/8 | 5/16 x 3/8 | 45/64 | 1/8 | 25/32 | 1/8 | 3-17/32 | 0.03 |
| FF-22.11/32X7/16 | 11/32 x 7/16 | 53/64 | 1/8 | 29/32 | 1/8 | 3-15/16 | 0.05 |
| FF-22.1/2X9/16 | 1/2 x 9/16 | 1-1/32 | 3/32 | 1-7/64 | 3/32 | 4-11/32 | 0.08 |

FACOM® SHORT SATIN METRIC OPEN END WRENCHES



- › Satin finish provides corrosion resistance and a slip-resistant grip.
- › Short shank and slim heads for access in confined spaces.
- › Standard open end configuration.



| Product # | Size (mm) | Outside Head Width (in) (C) | Head Thickness (in) (D) | Outside Head Width (in) (C1) | Head Thickness (in) (D1) | Overall Length (in) | Weight (lbs) |
|----------------------|-----------|-----------------------------|-------------------------|------------------------------|--------------------------|---------------------|--------------|
| FM-22.3.2X5.5 | 3.2 x 5.5 | 25/64 | 3/32 | 33/64 | 3/32 | 2-9/32 | 0.01 |
| FM-22.4X5 | 4 x 5 | 25/64 | 3/32 | 33/64 | 3/32 | 2-9/32 | 0.02 |
| FM-22.6X7 | 6 x 7 | 35/64 | 3/32 | 5/8 | 3/32 | 3-5/16 | 0.03 |
| FM-22.8X9 | 8 x 9 | 45/64 | 1/8 | 25/32 | 1/8 | 3-1/2 | 0.04 |
| FM-22.10X11 | 10 x 11 | 53/64 | 1/8 | 29/32 | 1/8 | 3-7/8 | 0.05 |
| FM-22.12X13 | 12 x 13 | 1-1/32 | 1/8 | 1-7/64 | 1/8 | 4-5/16 | 0.08 |

14 PIECE ANGLE OPEN END WRENCH SET

Product #: **J3100B**

| Contents | Size (in) | Overall Length (in) |
|----------|-----------|---------------------|
| J3112 | 3/8 | 4-3/4 |
| J3114 | 7/16 | 5 |
| J3116 | 1/2 | 5-1/4 |
| J3118 | 9/16 | 5-5/8 |
| J3120 | 5/8 | 6 |
| J3122 | 11/16 | 6-1/2 |
| J3124 | 3/4 | 7 |
| J3126 | 13/16 | 7-1/2 |
| J3128 | 7/8 | 8 |
| J3130 | 15/16 | 8-3/4 |
| J3132 | 1 | 9-1/2 |
| J3134 | 1-1/16 | 10-1/4 |
| J3136 | 1-1/8 | 11 |
| J3140 | 1-1/4 | 12-1/4 |
| J25TR08C | Tool Roll | |

- › Full polish finish provides corrosion resistance and easy to clean surfaces.
- › Double nickel strike for rust resistance and prolonged life.
- › 15° and 60° angle heads.
- › Weight (lbs): 5.58



ASME B107.100

11 PIECE METRIC ANGLE OPEN END WRENCH SET

METRIC

Product #: J3100M

- › Full polish finish provides corrosion and easy to clean surfaces.
- › 15° and 60° angle heads allow wrench to be used in four different turning angles for greater access in tight work areas.
- › Weight (lbs): 1.79

| Contents | Size (mm) | Overall Length (in) |
|----------|-----------|---------------------|
| J3109M | 9 | 4-3/4 |
| J3110M | 10 | 4-7/8 |
| J3111M | 11 | 5 |
| J3112M | 12 | 5-1/4 |
| J3113M | 13 | 5-1/2 |
| J3114M | 14 | 5-5/8 |
| J3115M | 15 | 5-15/16 |
| J3116M | 16 | 6-1/8 |
| J3117M | 17 | 6-1/2 |
| J3118M | 18 | 6-3/4 |
| J3119M | 19 | 7 |
| J25TR13C | Tool Roll | |

 ASME B107.100



7 PIECE ANGLE OPEN END WRENCH SET

Product #: J3100A

- › Full polish finish provides corrosion resistance and easy to clean surfaces.
- › 15° and 60° angle heads allow wrench to be used in four different turning angles for greater access in tight work areas.
- › Weight (lbs): 1.02

| Contents | Size (in) | Overall Length (in) |
|----------|-----------|---------------------|
| J3112 | 3/8 | 4-3/4 |
| J3114 | 7/16 | 5 |
| J3116 | 1/2 | 5-1/4 |
| J3118 | 9/16 | 5-5/8 |
| J3120 | 5/8 | 6 |
| J3122 | 11/16 | 6-1/2 |
| J3124 | 3/4 | 7 |
| J25TR07C | Tool Roll | |

 ASME B107.100

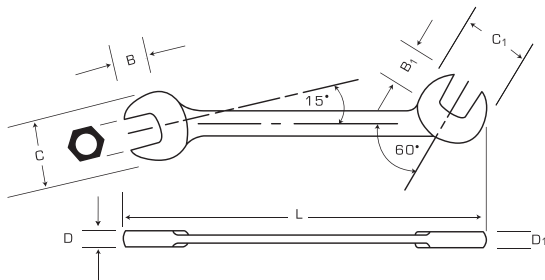

FULL POLISH ANGLE OPEN END WRENCHES

- › Full polish finish provides corrosion and easy to clean surfaces.
- › Double nickel strike for rust resistance and prolonged life.
- › 15° and 60° angle heads combined with the same size opening on both ends allow wrench to be used in four different turning angles for greater access in tight work areas.



| Product # | Size (in) | Throat Depth (in) (B) | Outside Head Width (in) (C) | Head Thickness (in) (D) | Throat Depth (in) (B1) | Outside Head Width (in) (C1) | Head Thickness (in) (D1) | Overall Length (in) | Weight (lbs) |
|-----------|-----------|-----------------------|-----------------------------|-------------------------|------------------------|------------------------------|--------------------------|---------------------|--------------|
| J3112 | 3/8 | 13/32 | 3/4 | 13/64 | 13/32 | 3/4 | 13/64 | 4-3/4 | 0.06 |
| J3114 | 7/16 | 15/32 | 7/8 | 13/64 | 15/32 | 7/8 | 13/64 | 5 | 0.08 |
| J3116 | 1/2 | 35/64 | 1 | 15/64 | 35/64 | 1 | 15/64 | 5-1/4 | 0.10 |
| J3118 | 9/16 | 39/64 | 1-7/64 | 15/64 | 39/64 | 1-7/64 | 15/64 | 5-5/8 | 0.14 |
| J3120 | 5/8 | 21/32 | 1-7/32 | 17/64 | 21/32 | 1-7/32 | 17/64 | 6 | 0.17 |
| J3122 | 11/16 | 23/32 | 1-21/64 | 17/64 | 23/32 | 1-21/64 | 17/64 | 6-1/2 | 0.21 |
| J3124 | 3/4 | 25/32 | 1-7/16 | 9/32 | 25/32 | 1-7/16 | 9/32 | 7 | 0.26 |
| J3126 | 13/16 | 27/32 | 1-9/16 | 19/64 | 27/32 | 1-9/16 | 19/64 | 7-1/2 | 0.50 |
| J3128 | 7/8 | 57/64 | 1-21/32 | 5/16 | 57/64 | 1-21/32 | 5/16 | 8 | 0.61 |
| J3130 | 15/16 | 31/32 | 1-25/32 | 21/64 | 31/32 | 1-25/32 | 21/64 | 8-3/4 | 0.71 |
| J3132 | 1 | 1-1/32 | 1-59/64 | 11/32 | 1-1/32 | 1-59/64 | 11/32 | 9-1/2 | 0.88 |
| J3134 | 1-1/16 | 1-1/16 | 2-1/64 | 23/64 | 1-1/16 | 2-1/64 | 23/64 | 10-1/4 | 1.04 |
| J3136 | 1-1/8 | 1-1/8 | 2-1/8 | 3/8 | 1-1/8 | 2-1/8 | 3/8 | 11 | 1.20 |
| J3140 | 1-1/4 | 1-1/4 | 2-11/32 | 13/32 | 1-1/4 | 2-11/32 | 13/32 | 12-1/4 | 1.47 |
| J3142 | 1-5/16 | 1-5/16 | 2-29/64 | 27/64 | 1-5/16 | 2-29/64 | 27/64 | 13-1/8 | 1.87 |
| J3144 | 1-3/8 | 1-13/32 | 2-37/64 | 7/16 | 1-13/32 | 2-37/64 | 7/16 | 13-3/4 | 2.17 |
| J3146 | 1-7/16 | 1-13/32 | 2-5/8 | 29/64 | 1-13/32 | 2-5/8 | 29/64 | 14 | 2.48 |
| J3148 | 1-1/2 | 1-31/64 | 2-3/4 | 15/32 | 1-31/64 | 2-3/4 | 15/32 | 14-1/2 | 2.77 |
| J3152 | 1-5/8 | 1-43/64 | 3-1/64 | 1/2 | 1-43/64 | 3-1/64 | 1/2 | 15 | 3.07 |
| J3156 | 1-3/4 | 1-31/32 | 3-31/64 | 33/64 | 1-31/32 | 3-31/64 | 33/64 | 17 | 3.81 |
| J3158 | 1-13/16 | 1-63/64 | 3-31/64 | 33/64 | 1-63/64 | 3-31/64 | 33/64 | 18-3/8 | 4.56 |
| J3160 | 1-7/8 | 2-7/32 | 3-29/32 | 21/32 | 2-7/32 | 3-29/32 | 21/32 | 19-3/4 | 5.24 |
| J3164 | 2 | 2-9/32 | 3-29/32 | 21/32 | 2-9/32 | 3-29/32 | 21/32 | 21-1/4 | 5.92 |



ASME B107.100

FULL POLISH METRIC ANGLE OPEN END WRENCHES



- › Full polish finish provides corrosion and easy to clean surfaces.
- › 15° and 60° angle heads allow wrench to be used in four different turning angles for greater access in tight work areas.



| Product # | Size (mm) | Throat Depth (in) (B) | Outside Head Width (in) (C) | Head Thickness (in) (D) | Throat Depth (in) (B1) | Outside Head Width (in) (C1) | Head Thickness (in) (D1) | Overall Length (in) | Weight (lbs) |
|-----------|-----------|-----------------------|-----------------------------|-------------------------|------------------------|------------------------------|--------------------------|---------------------|--------------|
| J3109M | 9 | 13/32 | 49/64 | 13/64 | 13/32 | 49/64 | 13/64 | 4-3/4 | 0.06 |
| J3110M | 10 | 7/16 | 13/16 | 13/64 | 7/16 | 13/16 | 13/64 | 4-7/8 | 0.07 |
| J3111M | 11 | 15/32 | 7/8 | 7/32 | 15/32 | 7/8 | 7/32 | 5 | 0.08 |
| J3112M | 12 | 1/2 | 59/64 | 15/64 | 1/2 | 59/64 | 15/64 | 5-1/4 | 0.10 |
| J3113M | 13 | 17/32 | 63/64 | 15/64 | 17/32 | 63/64 | 15/64 | 5-1/2 | 0.13 |
| J3114M | 14 | 39/64 | 1-7/64 | 1/4 | 39/64 | 1-7/64 | 1/4 | 5-5/8 | 0.14 |
| J3115M | 15 | 5/8 | 1-5/32 | 17/64 | 5/8 | 1-5/32 | 17/64 | 5-15/16 | 0.16 |
| J3116M | 16 | 21/32 | 1-7/32 | 17/64 | 21/32 | 1-7/32 | 17/64 | 6-1/8 | 0.19 |
| J3117M | 17 | 47/64 | 1-11/32 | 9/32 | 47/64 | 1-11/32 | 9/32 | 6-1/2 | 0.21 |
| J3118M | 18 | 23/32 | 1-11/32 | 9/32 | 23/32 | 1-11/32 | 9/32 | 6-3/4 | 0.24 |
| J3119M | 19 | 25/32 | 1-7/16 | 9/32 | 25/32 | 1-7/16 | 9/32 | 7 | 0.26 |



ASME B107.100



FACOM® 16 PIECE METRIC SHORT ANGLE OPEN END WRENCH SET

Product #: **FM-34.JL16T**



| Contents | Size (mm) | Overall Length (in) |
|-----------|-----------|---------------------|
| FM-34.3.2 | 3.2 | 2-3/4 |
| FM-34.4 | 4 | 2-3/4 |
| FM-34.5 | 5 | 2-61/64 |
| FM-34.5.5 | 5.5 | 2-61/64 |
| FM-34.6 | 6 | 3-5/32 |
| FM-34.7 | 7 | 3-5/32 |
| FM-34.8 | 8 | 3-35/64 |
| FM-34.9 | 9 | 3-35/64 |
| FM-34.10 | 10 | 3-15/16 |
| FM-34.11 | 11 | 3-15/16 |
| FM-34.12 | 12 | 3-15/16 |
| FM-34.13 | 13 | 4-23/32 |
| FM-34.14 | 14 | 4-23/32 |
| FM-34.15 | 15 | 5-33/64 |
| FM-34.16 | 16 | 5-33/64 |
| FM-34.17 | 17 | 5-33/64 |

- › Satin finish provides corrosion resistance and a slip-resistant grip.
- › 15° and 75° angled heads for fasteners out of standard-tool reach.
- › Short shanks and slim heads.
- › Standard open end configuration.
- › Weight (lbs): 1.12

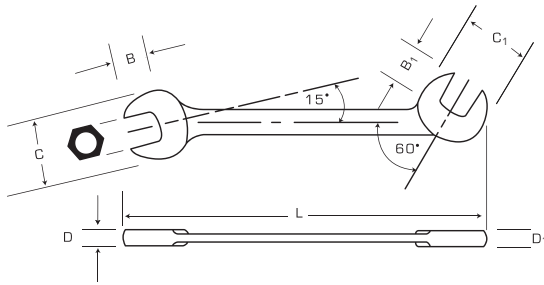

9 PIECE SHORT ANGLE OPEN END WRENCH SET

Product #: **J3300A**

| Contents | Size (in) | Overall Length (in) |
|----------|-----------|---------------------|
| J3314 | 7/32 | 3 |
| J3315 | 15/64 | 3 |
| J3316 | 1/4 | 3 |
| J3318 | 9/32 | 3-1/2 |
| J3320 | 5/16 | 3-1/2 |
| J3322 | 11/32 | 3-3/4 |
| J3324 | 3/8 | 3-3/4 |
| J3328 | 7/16 | 4-7/16 |
| J3332 | 1/2 | 4-7/16 |
| J25TR26C | Tool Roll | |

- › Satin finish.
- › 15° and 75° angle heads.
- › Compact shank design and short length for access in confined spaces.
- › Standard open end configuration.
- › Weight (lbs): 0.46



SHORT SATIN ANGLE OPEN END WRENCHES

- › Satin finish provides corrosion resistance and a slip-resistant grip.
- › 15° and 75° angle heads allow wrench to be used in four different turning angles for greater access in tight work spaces.
- › Compact shank design and short length for access in confined spaces.
- › Standard open end configuration.



| Product # | Size (in) | Throat Depth (in) (B) | Outside Head Width (in) (C) | Head Thickness (in) (D) | Throat Depth (in) (B1) | Outside Head Width (in) (C1) | Head Thickness (in) (D1) | Overall Length (in) | Weight (lbs) |
|--------------|-----------|-----------------------|-----------------------------|-------------------------|------------------------|------------------------------|--------------------------|---------------------|--------------|
| J3314 | 7/32 | 11/64 | 1/2 | 7/64 | 11/64 | 1/2 | 7/64 | 3 | 0.03 |
| J3315 | 15/64 | 11/64 | 1/2 | 7/64 | 11/64 | 1/2 | 7/64 | 3 | 0.03 |
| J3316 | 1/4 | 11/64 | 1/2 | 7/64 | 11/64 | 1/2 | 7/64 | 3 | 0.03 |
| J3318 | 9/32 | 3/16 | 19/32 | 5/32 | 3/16 | 19/32 | 5/32 | 3-1/2 | 0.04 |
| J3320 | 5/16 | 3/16 | 19/32 | 5/32 | 3/16 | 19/32 | 5/32 | 3-1/2 | 0.04 |
| J3322 | 11/32 | 1/4 | 3/4 | 5/32 | 1/4 | 3/4 | 5/32 | 3-3/4 | 0.05 |
| J3324 | 3/8 | 1/4 | 3/4 | 5/32 | 1/4 | 3/4 | 5/32 | 3-3/4 | 0.05 |
| J3328 | 7/16 | 11/32 | 1 | 11/64 | 11/32 | 1 | 11/64 | 4-7/16 | 0.08 |
| J3332 | 1/2 | 11/32 | 1 | 11/64 | 11/32 | 1 | 11/64 | 4-7/16 | 0.08 |
| J3336 | 9/16 | 13/32 | 1-5/32 | 3/16 | 13/32 | 1-5/32 | 3/16 | 5-3/4 | 0.10 |
| J3340 | 5/8 | 13/32 | 1-5/32 | 3/16 | 13/32 | 1-5/32 | 3/16 | 5-3/4 | 0.10 |



ASME B107.100



FACOM® SHORT SATIN METRIC ANGLE OPEN END WRENCHES

- › Satin finish provides corrosion resistance and slip-resistant grip.
- › 15° and 75° angled heads for fasteners out of standard tool reach.
- › Short shanks and slim heads.
- › Standard open end configuration.



| Product # | Size (mm) | Outside Head Width (in) (C) | Head Thickness (in) (D) | Outside Head Width (in) (C1) | Head Thickness (in) (D1) | Overall Length (in) | Weight (lbs) |
|------------------|-----------|-----------------------------|-------------------------|------------------------------|--------------------------|---------------------|--------------|
| FM-34.3.2 | 3.2 | 25/64 | 3/32 | 25/64 | 3/32 | 2-3/4 | 0.01 |
| FM-34.4 | 4 | 25/64 | 3/32 | 25/64 | 3/32 | 2-3/4 | 0.01 |
| FM-34.5 | 5 | 33/64 | 3/32 | 33/64 | 3/32 | 2-61/64 | 0.02 |
| FM-34.5.5 | 5.5 | 33/64 | 7/64 | 33/64 | 7/64 | 2-61/64 | 0.02 |
| FM-34.6 | 6 | 19/32 | 7/64 | 19/32 | 7/64 | 3-5/32 | 0.02 |
| FM-34.7 | 7 | 19/32 | 1/8 | 19/32 | 1/8 | 3-5/32 | 0.02 |
| FM-34.8 | 8 | 47/64 | 1/8 | 47/64 | 1/8 | 3-35/64 | 0.04 |
| FM-34.9 | 9 | 47/64 | 1/8 | 47/64 | 1/8 | 3-35/64 | 0.04 |
| FM-34.10 | 10 | 55/64 | 1/8 | 55/64 | 1/8 | 3-15/16 | 0.05 |
| FM-34.11 | 11 | 55/64 | 1/8 | 55/64 | 1/8 | 3-15/16 | 0.05 |
| FM-34.12 | 12 | 1-1/16 | 9/64 | 1-1/16 | 9/64 | 3-15/16 | 0.08 |
| FM-34.13 | 13 | 1-1/16 | 9/64 | 1-1/16 | 9/64 | 4-23/32 | 0.08 |
| FM-34.14 | 14 | 1-1/16 | 9/64 | 1-1/16 | 9/64 | 4-23/32 | 0.08 |
| FM-34.15 | 15 | 1-19/64 | 11/64 | 1-19/64 | 11/64 | 5-33/64 | 0.15 |
| FM-34.16 | 16 | 1-19/64 | 11/64 | 1-19/64 | 11/64 | 5-33/64 | 0.14 |
| FM-34.17 | 17 | 1-19/64 | 11/64 | 1-19/64 | 11/64 | 5-33/64 | 0.14 |

6 PIECE FACOM® METRIC TAPPET WRENCH SET



Product #: **FM-31.JE6T**

- › Satin finish provides corrosion resistance and a slip-resistant grip.
- › Used to tighten collars, lock nut rings and help seal packing nuts on hydraulic cylinders.
- › Ultra thin profile for use in close quarters.
- › Openings designed to cover tappets, screws and lock nuts with excessive overhang which helps improve access.
- › For use in low torque applications.
- › Standard open end configuration.
- › Weight (lbs): 1.63



| Contents | Size (mm) | Overall Length (in) |
|-------------|-----------|---------------------|
| FM-31.8X9 | 8 x 9 | 6-57/64 |
| FM-31.10X11 | 10 x 11 | 6-57/64 |
| FM-31.12X13 | 12 x 13 | 8-17/64 |
| FM-31.14X15 | 14 x 15 | 8-17/64 |
| FM-31.16X17 | 16 x 17 | 9-27/32 |
| FM-31.18X19 | 18 x 19 | 9-27/32 |

FACOM® SATIN METRIC TAPPET OPEN END WRENCHES



- › Satin finish provides corrosion resistance and a slip-resistant grip.
- › Used to tighten collars, lock nut rings and help seal packing nuts on hydraulic cylinders.
- › Ultra thin profile for use in close quarters.
- › Openings designed to cover tappets, screws and lock nuts with excessive overhang which helps improve access.
- › For use in low torque applications.
- › Standard open end configuration.



| Product # | Size (mm) | Outside Head Width (in) (C) | Head Thickness (in) (D) | Outside Head Width (in) (C1) | Head Thickness (in) (D1) | Overall Length (in) | Weight (lbs) |
|--------------------|-----------|-----------------------------|-------------------------|------------------------------|--------------------------|---------------------|--------------|
| FM-31.6X7 | 6 x 7 | 5/8 | 5/8 | 3/4 | 5/8 | 5-53/64 | 0.06 |
| FM-31.8X9 | 8 x 9 | 25/32 | 25/32 | 31/32 | 25/32 | 6-57/64 | 0.08 |
| FM-31.10X11 | 10 x 11 | 25/32 | 13/16 | 63/64 | 13/16 | 6-57/64 | 0.08 |
| FM-31.12X13 | 12 x 13 | 1-7/64 | 1-3/32 | 1-19/64 | 1-3/32 | 8-17/64 | 0.17 |
| FM-31.14X15 | 14 x 15 | 1-9/64 | 1-5/32 | 1-19/64 | 1-5/32 | 8-17/64 | 0.17 |
| FM-31.16X17 | 16 x 17 | 1-33/64 | 1-17/32 | 1-11/16 | 1-17/32 | 9-27/32 | 0.31 |
| FM-31.18X19 | 18 x 19 | 1-33/64 | 1-17/32 | 1-11/16 | 1-17/32 | 9-27/32 | 0.30 |



13 PIECE IGNITION SET

Product #: **J3200C**

| Contents | Size (in) | Overall Length (in) |
|----------|---------------------------|---------------------|
| J3210 | 13/64 x 15/64 | 3 |
| J3211 | 15/64 x 13/64 | 3 |
| J3215 | 7/32 x 1/4 | 3 |
| J3216 | 1/4 x 7/32 | 3 |
| J3220 | 9/32 x 5/16 | 3-1/2 |
| J3221 | 5/16 x 9/32 | 3-1/2 |
| J3225 | 11/32 x 3/8 | 3-3/4 |
| J3226 | 3/8 x 11/32 | 3-3/4 |
| J000D | Ignition Feeler Gauge Set | |
| J235 | Ignition Pliers | |
| J2302 | Ignition Point File | |
| J9853 | Screw Start | |
| 66-101 | Pocket Screwdriver | |
| J25TR10C | Tool Roll | |

- › Satin finish provides corrosion resistance and a slip-resistant grip.
- › 15° and 60° angle heads combined with the same opening size on both ends allows the wrench to be used in four different turning angles.
- › Standard open end wrench configuration.
- › Weight (lbs): 0.67



9 PIECE IGNITION SET

Product #: **J3200D**

| Contents | Size (in) | Overall Length (in) |
|----------|-----------------|---------------------|
| J3210 | 13/64 x 15/64 | 3 |
| J3211 | 15/64 x 13/64 | 3 |
| J3215 | 7/32 x 1/4 | 3 |
| J3216 | 1/4 x 7/32 | 3 |
| J3220 | 9/32 x 5/16 | 3-1/2 |
| J3221 | 5/16 x 9/32 | 3-1/2 |
| J3225 | 11/32 x 3/8 | 3-3/4 |
| J3226 | 3/8 x 11/32 | 3-3/4 |
| J235 | Ignition Pliers | |
| J25TR09C | Tool Roll | |

- › Satin finish provides corrosion resistance and a slip-resistant grip.
- › 15° and 60° angle heads combined with the same opening size on both ends allow the wrench to be used in four different turning angles.
- › Standard open end wrench configuration.
- › Weight (lbs): 0.47

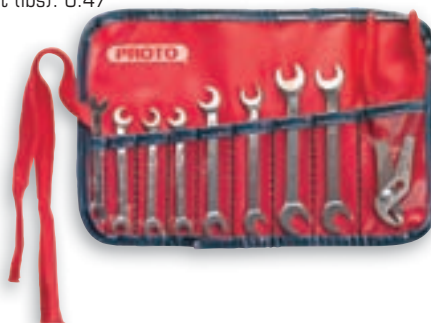

IGNITION WRENCHES

- › Satin finish provides corrosion resistance and a slip-resistant grip.
- › 15° and 60° angle heads combined with the same opening size on both ends allow the wrench to be used in four different turning angles.
- › Standard open end configuration.



| Product # | Size (in) | Throat Depth (in) (B) | Outside Head Width (in) (C) | Head Thickness (in) (D) | Throat Depth (in) (B1) | Outside Head Width (in) (C1) | Head Thickness (in) (D1) | Overall Length (in) | Weight (lbs) |
|--------------|---------------|-----------------------|-----------------------------|-------------------------|------------------------|------------------------------|--------------------------|---------------------|--------------|
| J3210 | 13/64 x 15/64 | 15/64 | 1/2 | 7/64 | 15/64 | 1/2 | 7/64 | 3 | 0.02 |
| J3211 | 15/64 x 13/64 | 15/64 | 1/2 | 7/64 | 15/64 | 1/2 | 7/64 | 3 | 0.02 |
| J3215 | 7/32 x 1/4 | 15/64 | 1/2 | 7/64 | 15/64 | 1/2 | 7/64 | 3 | 0.02 |
| J3216 | 1/4 x 7/32 | 15/64 | 1/2 | 7/64 | 15/64 | 1/2 | 7/64 | 3 | 0.02 |
| J3220 | 9/32 x 5/16 | 5/16 | 19/32 | 5/32 | 5/16 | 19/32 | 5/32 | 3-1/2 | 0.03 |
| J3221 | 5/16 x 9/32 | 5/16 | 19/32 | 5/32 | 5/16 | 19/32 | 5/32 | 3-1/2 | 0.03 |
| J3225 | 11/32 x 3/8 | 3/8 | 3/4 | 5/32 | 3/8 | 47/64 | 5/32 | 3-3/4 | 0.05 |
| J3226 | 3/8 x 11/32 | 3/8 | 3/4 | 5/32 | 3/8 | 3/4 | 5/32 | 3-3/4 | 0.05 |

BLACK OXIDE CHECK NUT WRENCHES

- › Use check nut wrenches to tighten jam nuts, check nuts or lock nuts.
- › In confined spaces, the 15° head allows for a full 30° rotation by flipping wrench over.
- › Ultra thin profile improves access in close quarters.
- › Non-reflective black oxide finish for use where non-plated products are required.



| Product # | Size (in) | Outside Head Width (in) (C) | Head Thickness (in) (D) | Overall Length (in) | Weight (lbs) |
|-----------|-----------|-----------------------------|-------------------------|---------------------|--------------|
| JKE14 | 7/16 | 1 | 7/32 | 4 | 0.05 |
| JKE16 | 1/2 | 1 | 7/32 | 4 | 0.05 |
| JKE18 | 9/16 | 1-9/32 | 7/32 | 4-1/2 | 0.11 |
| JKE19 | 19/32 | 1-9/32 | 7/32 | 4-1/2 | 0.11 |
| JKE20 | 5/8 | 1-1/2 | 7/32 | 5-1/8 | 0.13 |
| JKE22 | 11/16 | 1-1/2 | 7/32 | 5-1/8 | 0.13 |
| JKE24 | 3/4 | 1-23/32 | 9/32 | 6-1/8 | 0.19 |
| JKE26 | 13/16 | 2 | 9/32 | 6-5/8 | 0.28 |
| JKE28 | 7/8 | 1-25/32 | 9/32 | 6-5/8 | 0.28 |
| JKE30 | 15/16 | 2 | 9/32 | 7-1/2 | 0.36 |
| JKE32 | 1 | 2 | 9/32 | 7-1/2 | 0.35 |
| JKE34 | 1-1/16 | 2-13/32 | 9/32 | 8-1/2 | 0.66 |
| JKE36 | 1-1/8 | 2-13/32 | 9/32 | 8-1/2 | 0.65 |
| JKE40 | 1-1/4 | 2-23/32 | 13/32 | 10 | 1.12 |
| JKE42 | 1-5/16 | 2-23/32 | 13/32 | 10 | 1.12 |
| JKE48 | 1-1/2 | 3-7/32 | 13/32 | 11-3/8 | 1.50 |
| JKE52 | 1-5/8 | 3-1/2 | 13/32 | 13 | 2.30 |
| JKE54 | 1-11/16 | 3-7/16 | 1/2 | 13 | 2.20 |



THE STORY BEHIND CHECK NUT WRENCHES



The Check Nut Wrench tightens fasteners (sometimes called Lock Nuts or Jam Nuts) that lock other fasteners in place. The thin profile is used to squeeze into a tight space, or to rotate a fastener without moving the one next to it.

Check Nut Wrenches approach the fastener almost straight-on. The slight angle makes it easier for both left- and right-handed work.

SATIN SERVICE WRENCHES

- › Satin finish provides corrosion resistance and a slip-resistant grip.
- › 30° angle head allows access to difficult to reach fasteners.
- › Thin pattern for use on jam nuts, check nuts or lock nuts.
- › Short shank allows for use in confined spaces.



| Product # | Size (in) | Throat Depth (in) (B) | Outside Head Width (in) (C) | Head Thickness (in) (D) | Overall Length (in) | Weight (lbs) |
|-----------|-----------|-----------------------|-----------------------------|-------------------------|---------------------|--------------|
| J3524 | 3/4 | 7/32 | 1-11/16 | 1/4 | 6-1/4 | 0.22 |
| J3526 | 13/16 | 7/32 | 1-11/16 | 1/4 | 6-1/4 | 0.22 |
| J3528 | 7/8 | 7/32 | 1-11/16 | 1/4 | 6-1/4 | 0.22 |
| J3530 | 15/16 | 1/4 | 1-7/8 | 1/4 | 6-7/8 | 0.25 |
| J3532 | 1 | 1/4 | 1-7/8 | 1/4 | 6-7/8 | 0.25 |
| J3534 | 1-1/16 | 1/4 | 1-7/8 | 1/4 | 6-7/8 | 0.25 |
| J3536 | 1-1/8 | 5/16 | 2-1/16 | 1/4 | 7 | 0.31 |
| J3538 | 1-3/16 | 5/16 | 2-1/16 | 1/4 | 7 | 0.31 |
| J3540 | 1-1/4 | 19/64 | 2-1/16 | 1/4 | 7 | 0.45 |
| J3542 | 1-5/16 | 29/64 | 2-1/2 | 9/32 | 7-5/8 | 0.44 |
| J3544 | 1-3/8 | 7/16 | 2-1/2 | 9/32 | 7-5/8 | 0.43 |
| J3546 | 1-7/16 | 7/16 | 2-1/2 | 9/32 | 7-5/8 | 0.42 |
| J3548 | 1-1/2 | 27/64 | 2-1/2 | 9/32 | 7-5/8 | 0.43 |
| J3550 | 1-9/16 | 7/16 | 2-5/8 | 9/32 | 7-5/8 | 0.43 |
| J3552 | 1-5/8 | 7/16 | 2-5/8 | 9/32 | 7-5/8 | 0.42 |
| J3554 | 1-11/16 | 27/64 | 2-5/8 | 9/32 | 7-5/8 | 0.7 |
| J3556 | 1-3/4 | 45/64 | 3-1/8 | 5/16 | 8-1/2 | 0.69 |
| J3558 | 1-13/16 | 11/16 | 3-1/8 | 5/16 | 8-1/2 | 0.69 |
| J3560 | 1-7/8 | 11/16 | 3-1/8 | 5/16 | 8-1/2 | 0.68 |
| J3562 | 1-15/16 | 11/16 | 3-1/8 | 5/16 | 8-1/2 | 0.68 |
| J3564 | 2 | 21/32 | 3-1/2 | 5/16 | 8-1/2 | 0.66 |
| J3568 | 2-1/8 | 21/32 | 3-1/2 | 5/16 | 8-1/2 | 0.65 |
| J3572 | 2-1/4 | 39/64 | 3-1/2 | 5/16 | 8-1/2 | 0.61 |
| J3576 | 2-3/8 | 39/64 | 3-1/2 | 5/16 | 8-1/2 | 0.61 |
| J3580 | 2-1/2 | 19/32 | 3-1/2 | 5/16 | 8-1/2 | 0.59 |
| J3582 | 2-9/16 | 9/16 | 3-1/2 | 5/16 | 8-1/2 | 0.57 |



THE STORY BEHIND SERVICE WRENCHES

Service, Check Nut and Tappet wrenches look similar, but they serve different purposes. Used in low-torque situations, they tighten fasteners in automotive or plumbing applications where access is frequently tight and travel is part of the job.

The Service Wrench provides an extra-large head on a short, tapered shank. The 30° angle on the handle allows for double rotation in tight spots by just flipping the wrench.

These wrenches are designed as a small, but strong set of hand wrenches ideal for traveling to various job sites.

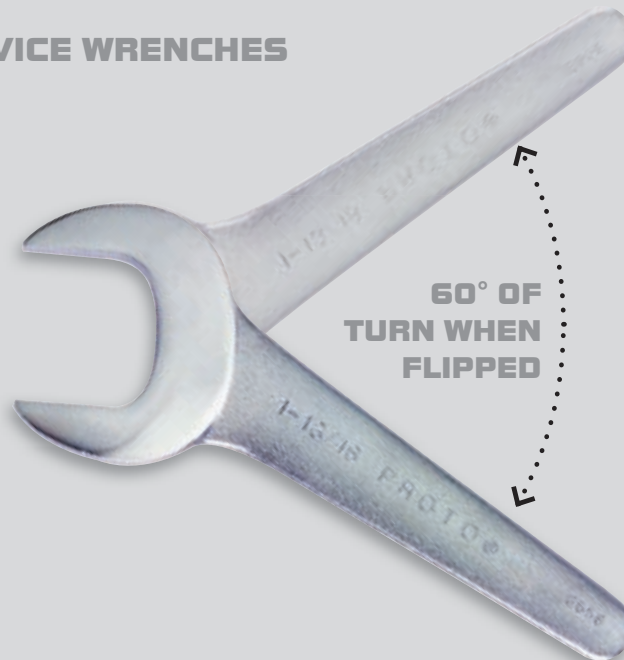

60° OF
TURN WHEN
FLIPPED

SATIN METRIC SERVICE WRENCHES

METRIC

- › Satin finish provides corrosion resistance and a slip-resistant grip.
- › 30° angle head allows access to difficult to reach fasteners.
- › Thin pattern for use on jam nuts, check nuts or lock nuts.
- › Short shank allows for use in confined spaces.



| Product # | Size (mm) | Outside Head Width (in) (C) | Head Thickness (in) (D) | Overall Length (in) | Weight (lbs) |
|---------------|-----------|-----------------------------|-------------------------|---------------------|--------------|
| J3519M | 19 | 1-11/16 | 1/4 | 6-1/4 | 0.22 |
| J3521M | 21 | 1-11/16 | 1/4 | 6-1/4 | 0.22 |
| J3522M | 22 | 1-11/16 | 1/4 | 6-1/4 | 0.22 |
| J3524M | 24 | 1-7/8 | 1/4 | 6-7/8 | 0.25 |
| J3527M | 27 | 1-7/8 | 1/4 | 6-7/8 | 0.25 |
| J3530M | 30 | 2-1/16 | 1/4 | 7 | 0.31 |
| J3532M | 32 | 2-1/16 | 1/4 | 7 | 0.30 |
| J3536M | 36 | 2-1/2 | 1/4 | 7-5/8 | 0.45 |
| J3537M | 37 | 2-1/2 | 9/32 | 7-5/8 | 0.43 |
| J3538M | 38 | 2-1/2 | 9/32 | 7-5/8 | 0.42 |
| J3540M | 40 | 2-5/8 | 9/32 | 7-5/8 | 0.43 |
| J3541M | 41 | 2-5/8 | 9/32 | 7-5/8 | 0.43 |
| J3542M | 42 | 2-5/8 | 9/32 | 7-5/8 | 0.43 |
| J3544M | 44 | 2-5/8 | 9/32 | 7-5/8 | 0.43 |
| J3546M | 46 | 3-1/8 | 9/32 | 7-5/8 | 0.70 |
| J3548M | 48 | 3-1/8 | 5/16 | 8-1/2 | 0.70 |
| J3550M | 50 | 3-1/8 | 5/16 | 8-1/2 | 0.68 |
| J3552M | 52 | 3-1/2 | 5/16 | 8-1/2 | 0.66 |
| J3555M | 55 | 3-1/2 | 5/16 | 8-1/2 | 0.66 |
| J3560M | 60 | 3-1/2 | 5/16 | 8-1/2 | 0.61 |
| J3565M | 65 | 3-1/2 | 5/16 | 8-1/2 | 0.57 |



FACOM® INSULATED VSE METRIC OPEN END WRENCHES

- › 2 color warning handle insulation - color changes from orange to yellow if insulation integrity compromised.
- › Specific heat treatment and oiled quenching achieve core hardness without embrittlement or distortion.
- › Size tolerances applied by Facom® exceed standard specifications.

FACOM®

METRIC



| Product # | Size (mm) | Outside Head Width (in) (C) | Head Thickness (in) (D) | Overall Length (in) | Weight (lbs) |
|---------------------|-----------|-----------------------------|-------------------------|---------------------|--------------|
| FM-46.8AVSE | 8 | 55/64 | 5/16 | 4-23/32 | 0.07 |
| FM-46.9AVSE | 9 | 15/16 | 23/64 | 4-29/32 | 0.09 |
| FM-46.10AVSE | 10 | 63/64 | 23/64 | 5-1/8 | 0.11 |
| FM-46.11AVSE | 11 | 1-9/64 | 25/64 | 5-5/16 | 0.12 |
| FM-46.12AVSE | 12 | 1-3/16 | 25/64 | 5-5/16 | 0.14 |
| FM-46.13AVSE | 13 | 1-17/64 | 7/16 | 5-29/32 | 0.17 |
| FM-46.14AVSE | 14 | 1-11/32 | 7/16 | 6-5/16 | 0.20 |
| FM-46.15AVSE | 15 | 1-27/64 | 7/16 | 6-5/16 | 0.20 |
| FM-46.16AVSE | 16 | 1-1/2 | 15/32 | 6-11/16 | 0.26 |
| FM-46.17AVSE | 17 | 1-39/64 | 15/32 | 7-3/32 | 0.29 |
| FM-46.18AVSE | 18 | 1-21/32 | 15/32 | 7-3/32 | 0.33 |
| FM-46.19AVSE | 19 | 1-49/64 | 15/32 | 7-11/16 | 0.34 |
| FM-46.21AVSE | 21 | 1-31/32 | 35/64 | 7-9/32 | 0.40 |

6 PIECE 1/4" DRIVE CROWFOOT WRENCH SET

Product #: **J4700CF**

- › Crowfoot wrenches are used in hard to reach, restricted access situations where a standard wrench or ratchet cannot reach.
- › Anti-Slip Design open end (ASD).
- › The arched surfaces are designed to spread the contact forces over a greater area and they keep the loads off the corners of the fastener which helps prevent fastener rounding.
- › Broad size range ensures the right tool for the application will be available.
- › Typically used in lower torque applications.
- › Full Polish finish provides corrosion resistance and easy to clean surfaces.
- › Use with locking extensions to reach into spaces too small for a mechanic's arm or where the fastener is out of site.
- › Weight (lbs): 0.41



| Contents | Size (in) | Overall Length (in) |
|----------|-----------|---------------------|
| J4708CF | 1/4 | 15/16 |
| J4710CF | 5/16 | 1 |
| J4712CF | 3/8 | 1-1/16 |
| J4714CF | 7/16 | 1-5/32 |
| J4716CF | 1/2 | 1-3/16 |
| J4718CF | 9/16 | 1-9/32 |

 ASME B107.21

8 PIECE 1/4" DRIVE CROWFOOT WRENCH SET WITH LOCKING EXTENSIONS

Product #: **J47000CFL**

- › Crowfoot wrenches are used in hard to reach, restricted access situations where a standard wrench or ratchet cannot reach
- › Anti-Slip Design open end (ASD).
- › The arched surfaces are designed to spread the contact forces over a greater area and they keep the loads off the corners of the fastener which helps prevent fastener rounding.
- › Broad size range ensures the right tool for the application will be available.
- › Typically used in lower torque applications.
- › Full Polish finish provides corrosion resistance and easy to clean surfaces.
- › Use with locking extensions to reach into spaces too small for a mechanic's arm or where the fastener is out of site.
- › Weight (lbs): 0.63

| Contents | Size (in) | Overall Length (in) |
|----------|-------------------|---------------------|
| J4708CF | 1/4 | 15/16 |
| J4710CF | 5/16 | 1 |
| J4712CF | 3/8 | 1-1/16 |
| J4714CF | 7/16 | 1-5/32 |
| J4716CF | 1/2 | 1-3/16 |
| J4718CF | 9/16 | 1-9/32 |
| J4761L | Locking Extension | 6 |
| J4759L | Locking Extension | 2 |



ASME B107.21



7 PIECE 1/4" DRIVE METRIC CROWFOOT WRENCH SET

METRIC

Product #: **J47000MCF**

- › Crowfoot wrenches are used in hard to reach, restricted access situations where a standard wrench or ratchet cannot reach.
- › Anti-Slip Design open end (ASD).
- › The arched surfaces are designed to spread the contact forces over a greater area and they keep the loads off the corners of the fastener which helps prevent fastener rounding.
- › Broad size range ensures the right tool for the application will be available.
- › Typically used in lower torque applications.
- › Full Polish finish provides corrosion resistance and easy to clean surfaces.
- › Use with locking extensions to reach into spaces too small for a mechanic's arm or where the fastener is out of site.
- › Weight (lbs): 0.47

| Contents | Size (mm) | Overall Length (in) |
|----------|-----------|---------------------|
| J4707MCF | 7 | 15/16 |
| J4708MCF | 8 | 31/32 |
| J4710MCF | 10 | 1-1/16 |
| J4711MCF | 11 | 1-1/8 |
| J4712MCF | 12 | 1-5/32 |
| J4713MCF | 13 | 1-3/16 |
| J4714MCF | 14 | 1-1/4 |



ASME B107.21



53 PIECE 3/8" DRIVE CROWFOOT WRENCH SET

Product #: **J49000CFL**

| Contents | Size (in) | Point Count | Overall Length (in) |
|-----------|-------------------|-------------|---------------------|
| J4912CF | 3/8 | - | 1-13/64 |
| J4914CF | 7/16 | - | 1-3/16 |
| J4916CF | 1/2 | - | 1-5/16 |
| J4918CF | 9/16 | - | 1-9/32 |
| J4920CF | 5/8 | - | 1-1/2 |
| J4922CF | 11/16 | - | 1-31/64 |
| J4924CF | 3/4 | - | 1-41/64 |
| J4926CF | 13/16 | - | 1-5/8 |
| J4928CF | 7/8 | - | 1-19/32 |
| J4930CF | 15/16 | - | 1-5/8 |
| J4932CF | 1 | - | 1-49/64 |
| J4934CF | 1-1/16 | - | 2-3/16 |
| J4936CF | 1-1/8 | - | 2-7/32 |
| J4938CF | 1-3/16 | - | 2-9/32 |
| J4940CF | 1-1/4 | - | 2-5/32 |
| J4942CF | 1-5/16 | - | 2-1/2 |
| J4944CF | 1-3/8 | - | 2-1/2 |
| J4946CF | 1-7/16 | - | 2-5/8 |
| J4948CF | 1-1/2 | - | 2-11/16 |
| J4950CF | 1-9/16 | - | 2-3/4 |
| J4952CF | 1-5/8 | - | 2-13/16 |
| J4954CF | 1-11/16 | - | 2-15/16 |
| J4956CF | 1-3/4 | - | 2-15/16 |
| J4958CF | 1-13/16 | - | 3-1/16 |
| J4960CF | 1-7/8 | - | 3-1/8 |
| J4962CF | 1-15/16 | - | 3-1/4 |
| J4964CF | 2 | - | 3-3/8 |
| J4966CF | 2-1/16 | - | 3-7/16 |
| J4968CF | 2-1/8 | - | 3-7/16 |
| J4970CF | 2-3/16 | - | 3-5/8 |
| J4972CF | 2-1/4 | - | 3-11/16 |
| J4974CF | 2-5/16 | - | 3-3/4 |
| J4976CF | 2-3/8 | - | 3-15/16 |
| J4978CF | 2-7/16 | - | 4-1/4 |
| J4980CF | 2-1/2 | - | 4-1/4 |
| J4982CF | 2-9/16 | - | 4-5/16 |
| J4984CF | 2-5/8 | - | 4-1/2 |
| J4986CF | 2-11/16 | - | 4-9/16 |
| J4988CF | 2-3/4 | - | 4-11/16 |
| J4990CF | 2-13/16 | - | 4-13/16 |
| J4992CF | 2-7/8 | - | 4-15/16 |
| J4994CF | 2-15/16 | - | 4-15/16 |
| J4996CF | 3 | - | 5 |
| J4920FL | 5/8 | 12 | - |
| J4922FL | 11/16 | 12 | - |
| J4924FL | 3/4 | 12 | - |
| J4926FL | 13/16 | 12 | - |
| J4928FL | 7/8 | 12 | - |
| J4930FL | 15/16 | 12 | - |
| J4932FL | 1 | 12 | - |
| J4934FL | 1-1/16 | 12 | - |
| J5262L | Locking Extension | - | 12 |
| J5260-06L | Locking Extension | - | 6 |

 ASME B107.21

- › Crowfoot wrenches are used in hard to reach, restricted access situations where a standard wrench or ratchet cannot reach.
- › Anti-Slip Design open end (ASD).
- › The arched surfaces are designed to spread the contact forces over a greater area and they keep the loads off the corners of the fastener which helps prevent fastener rounding.
- › Broad size range ensures the right tool for the application will be available.
- › Typically used in lower torque applications.
- › Full polish finish provides corrosion resistance and easy to clean surfaces.
- › Locking hole feature helps keep the crowfoot wrench engaged on the extension during use reducing downtime due to detachment of crowfoot in awkward spaces.
- › Use with locking extensions to reach into small spaces or where the fastener is out of sight.
- › Locking hole on 3/8" drive crowfoot wrenches available on fractional openings 1" and larger.
- › Weight (lbs): 26.14



43 PIECE 3/8" DRIVE CROWFOOT WRENCH SET

Product #: **J49001CF**

| Contents | Size (in) | Overall Length (in) |
|----------|-----------|---------------------|
| J4912CF | 3/8 | 1-13/64 |
| J4914CF | 7/16 | 1-3/16 |
| J4916CF | 1/2 | 1-5/16 |
| J4918CF | 9/16 | 1-9/32 |
| J4920CF | 5/8 | 1-1/2 |
| J4922CF | 11/16 | 1-31/64 |
| J4924CF | 3/4 | 1-41/64 |
| J4926CF | 13/16 | 1-5/8 |
| J4928CF | 7/8 | 1-19/32 |
| J4930CF | 15/16 | 1-5/8 |
| J4932CF | 1 | 1-49/64 |
| J4934CF | 1-1/16 | 2-3/16 |
| J4936CF | 1-1/8 | 2-7/32 |
| J4938CF | 1-3/16 | 2-9/32 |
| J4940CF | 1-1/4 | 2-5/32 |
| J4942CF | 1-5/16 | 2-1/2 |
| J4944CF | 1-3/8 | 2-1/2 |
| J4946CF | 1-7/16 | 2-5/8 |
| J4948CF | 1-1/2 | 2-11/16 |
| J4950CF | 1-9/16 | 2-3/4 |
| J4952CF | 1-5/8 | 2-13/16 |
| J4954CF | 1-11/16 | 2-15/16 |
| J4956CF | 1-3/4 | 2-15/16 |
| J4958CF | 1-13/16 | 3-1/16 |
| J4960CF | 1-7/8 | 3-1/8 |
| J4962CF | 1-15/16 | 3-1/4 |
| J4964CF | 2 | 3-3/8 |
| J4966CF | 2-1/16 | 3-7/16 |
| J4968CF | 2-1/8 | 3-7/16 |
| J4970CF | 2-3/16 | 3-5/8 |
| J4972CF | 2-1/4 | 3-11/16 |
| J4974CF | 2-5/16 | 3-3/4 |
| J4976CF | 2-3/8 | 3-15/16 |
| J4978CF | 2-7/16 | 4-1/4 |
| J4980CF | 2-1/2 | 4-1/4 |
| J4982CF | 2-9/16 | 4-5/16 |
| J4984CF | 2-5/8 | 4-1/2 |
| J4986CF | 2-11/16 | 4-9/16 |
| J4988CF | 2-3/4 | 4-11/16 |
| J4990CF | 2-13/16 | 4-13/16 |
| J4992CF | 2-7/8 | 4-15/16 |
| J4994CF | 2-15/16 | 4-15/16 |
| J4996CF | 3 | 5 |



ASME B107.21

- › Crowfoot wrenches are used in hard to reach, restricted access situations where a standard wrench or ratchet cannot reach.
- › Anti-Slip Design open end (ASD).
- › The arched surfaces are designed to spread the contact forces over a greater area and they keep the loads off the corners of the fastener which helps prevent fastener rounding.
- › Broad size range ensures the right tool for the application will be available.
- › Typically used in lower torque applications.
- › Full polish finish provides corrosion resistance and easy to clean surfaces.
- › Locking hole feature helps keep the crowfoot wrench engaged on the extension during use reducing downtime due to detachment of crowfoot in awkward spaces.
- › Use with locking extensions to reach into small spaces or where the fastener is out of sight.
- › Locking hole on 3/8" drive crowfoot wrenches available on fractional openings 1" and larger.
- › Weight (lbs): 23.92



27 PIECE 3/8" DRIVE CROWFOOT WRENCH SET

Product #: J49002CF

| Contents | Size (in) | Overall Length (in) |
|----------|-----------|---------------------|
| J4912CF | 3/8 | 1-13/64 |
| J4914CF | 7/16 | 1-3/16 |
| J4916CF | 1/2 | 1-5/16 |
| J4918CF | 9/16 | 1-9/32 |
| J4920CF | 5/8 | 1-1/2 |
| J4922CF | 11/16 | 1-31/64 |
| J4924CF | 3/4 | 1-41/64 |
| J4926CF | 13/16 | 1-5/8 |
| J4928CF | 7/8 | 1-19/32 |
| J4930CF | 15/16 | 1-5/8 |
| J4932CF | 1 | 1-49/64 |
| J4934CF | 1-1/16 | 2-3/16 |
| J4936CF | 1-1/8 | 2-7/32 |
| J4938CF | 1-3/16 | 2-9/32 |
| J4940CF | 1-1/4 | 2-5/32 |
| J4942CF | 1-5/16 | 2-1/2 |
| J4944CF | 1-3/8 | 2-1/2 |
| J4946CF | 1-7/16 | 2-5/8 |
| J4948CF | 1-1/2 | 2-11/16 |
| J4950CF | 1-9/16 | 2-3/4 |
| J4952CF | 1-5/8 | 2-13/16 |
| J4954CF | 1-11/16 | 2-15/16 |
| J4956CF | 1-3/4 | 2-15/16 |
| J4958CF | 1-13/16 | 3-1/16 |
| J4960CF | 1-7/8 | 3-1/8 |
| J4962CF | 1-15/16 | 3-1/4 |
| J4964CF | 2 | 3-3/8 |



ASME B107.21

- › Crowfoot wrenches are used in hard to reach, restricted access situations where a standard wrench or ratchet cannot reach.
- › Anti-Slip Design open end (ASD).
- › The arched surfaces are designed to spread the contact forces over a greater area and they keep the loads off the corners of the fastener which helps prevent fastener rounding.
- › Broad size range ensures the right tool for the application will be available.
- › Typically used in lower torque applications.
- › Full polish finish provides corrosion resistance and easy to clean surfaces.
- › Locking hole feature helps keep the crowfoot wrench engaged on the extension during use reducing downtime due to detachment of crowfoot in awkward spaces.
- › Use with locking extensions to reach into small spaces or where the fastener is out of sight.
- › Locking hole on 3/8" drive crowfoot wrenches available on fractional openings 1" and larger.
- › Weight (lbs): 6.74



16 PIECE 3/8" DRIVE METRIC CROWFOOT WRENCH SET

METRIC

Product #: J49000-MCF

| Contents | Size (mm) | Overall Length (in) |
|----------|-----------|---------------------|
| J4909MCF | 9 | 1-5/6 |
| J4910MCF | 10 | 1-11/32 |
| J4911MCF | 11 | 1-3/8 |
| J4912MCF | 12 | 1-15/32 |
| J4913MCF | 13 | 1-1/2 |
| J4914MCF | 14 | 1-1/2 |
| J4915MCF | 15 | 1-5/8 |
| J4916MCF | 16 | 1-21/32 |
| J4917MCF | 17 | 1-23/32 |
| J4918MCF | 18 | 1-15/16 |
| J4919MCF | 19 | 1-15/16 |
| J4920MCF | 20 | 2-1/16 |
| J4921MCF | 21 | 2-3/32 |
| J4922MCF | 22 | 2-7/32 |
| J4923MCF | 23 | 2-11/32 |
| J4924MCF | 24 | 2-13/32 |



ASME B107.21

- › Crowfoot wrenches are used in hard to reach, restricted access situations where a standard wrench or ratchet cannot reach.
- › Anti-Slip Design open end (ASD).
- › The arched surfaces are designed to spread the contact forces over a greater area and they keep the loads off the corners of the fastener which helps prevent fastener rounding.
- › Broad size range ensures the right tool for the application will be available.
- › Typically used in lower torque applications.
- › Full polish finish provides corrosion resistance and easy to clean surfaces.
- › Weight (lbs): 2.59



15 PIECE 3/8" DRIVE CROWFOOT WRENCH SET

Product #: J49003CF

| Contents | Size (in) | Overall Length (in) |
|----------|-----------|---------------------|
| J4912CF | 3/8 | 1-13/64 |
| J4914CF | 7/16 | 1-3/16 |
| J4916CF | 1/2 | 1-5/16 |
| J4918CF | 9/16 | 1-9/32 |
| J4920CF | 5/8 | 1-1/2 |
| J4922CF | 11/16 | 1-31/64 |
| J4924CF | 3/4 | 1-41/64 |
| J4926CF | 13/16 | 1-5/8 |
| J4928CF | 7/8 | 1-19/32 |
| J4930CF | 15/16 | 1-5/8 |
| J4932CF | 1 | 1-49/64 |
| J4934CF | 1-1/16 | 2-3/16 |
| J4936CF | 1-1/8 | 2-7/32 |
| J4938CF | 1-3/16 | 2-9/32 |
| J4940CF | 1-1/4 | 2-5/32 |



ASME B107.21

- › Crowfoot wrenches are used in hard to reach, restricted access situations where a standard wrench or ratchet cannot reach.
- › Anti-Slip Design open end (ASD).
- › The arched surfaces are designed to spread the contact forces over a greater area and they keep the loads off the corners of the fastener which helps prevent fastener rounding.
- › Broad size range ensures the right tool for the application will be available.
- › Typically used in lower torque applications.
- › Full polish finish provides corrosion resistance and easy to clean surfaces.
- › Locking hole feature helps keep the crowfoot wrench engaged on the extension during use reducing downtime due to detachment of crowfoot in awkward spaces.
- › Use with locking extensions to reach into small spaces or where the fastener is out of sight.
- › Locking hole on 3/8" drive crowfoot wrenches available on fractional openings 1" and larger.
- › Weight (lbs): 2.07



9 PIECE 3/8" DRIVE CROWFOOT WRENCH SET

Product #: **J49004CF**

- › Crowfoot wrenches are used in hard to reach, restricted access situations where a standard wrench or ratchet cannot reach.
- › Anti-Slip Design open end (ASD).
- › The arched surfaces are designed to spread the contact forces over a greater area and they keep the loads off the corners of the fastener which helps prevent fastener rounding.
- › Broad size range ensures the right tool for the application will be available.
- › Typically used in lower torque applications.
- › Full polish finish provides corrosion resistance and easy to clean surfaces.
- › Locking hole feature helps keep the crowfoot wrench engaged on the extension during use reducing downtime due to detachment of crowfoot in awkward spaces.
- › Use with locking extensions to reach into small spaces or where the fastener is out of sight.
- › Locking hole on 3/8" drive crowfoot wrenches available on fractional openings 1" and larger.
- › Weight (lbs): 0.83

| Contents | Size (in) | Overall Length (in) |
|----------|-----------|---------------------|
| J4912CF | 3/8 | 1-13/64 |
| J4914CF | 7/16 | 1-3/16 |
| J4916CF | 1/2 | 1-5/16 |
| J4918CF | 9/16 | 1-9/32 |
| J4920CF | 5/8 | 1-1/2 |
| J4922CF | 11/16 | 1-31/64 |
| J4924CF | 3/4 | 1-41/64 |
| J4926CF | 13/16 | 1-5/8 |
| J4928CF | 7/8 | 1-19/32 |

 ASME B107.21



22 PIECE 1/2" DRIVE CROWFOOT WRENCH SET

Product #: **J5300CF**

| Contents | Size (in) | Overall Length (in) |
|----------|-----------|---------------------|
| J5330CF | 15/16 | 2-13/16 |
| J5332CF | 1 | 2-13/16 |
| J5334CF | 1-1/16 | 2-7/8 |
| J5336CF | 1-1/8 | 3 |
| J5338CF | 1-3/16 | 3 |
| J5340CF | 1-1/4 | 3-5/16 |
| J5342CF | 1-5/16 | 3-5/16 |
| J5344CF | 1-3/8 | 3-3/8 |
| J5346CF | 1-7/16 | 3-3/8 |
| J5348CF | 1-1/2 | 3-7/16 |
| J5350CF | 1-9/16 | 3-1/2 |
| J5352CF | 1-5/8 | 3-1/2 |
| J5354CF | 1-11/16 | 3-13/16 |
| J5356CF | 1-3/4 | 3-13/16 |
| J5358CF | 1-13/16 | 3-7/8 |
| J5360CF | 1-7/8 | 3-7/8 |
| J5364CF | 2 | 3-15/16 |
| J5368CF | 2-1/8 | 4-1/16 |
| J5372CF | 2-1/4 | 4-3/8 |
| J5376CF | 2-3/8 | 4-7/16 |
| J5378CF | 2-7/16 | 4-7/16 |
| J5380CF | 2-1/2 | 4-1/2 |

 ASME B107.21



- › Crowfoot wrenches are used in hard to reach, restricted access situations where a standard wrench or ratchet cannot reach.
- › Anti-Slip Design open end (ASD).
- › The arched surfaces are designed to spread the contact forces over a greater area and they keep the loads off the corners of the fastener which helps prevent fastener rounding.
- › Broad size range ensures the right tool for the application will be available.
- › Typically used in lower torque applications.
- › Full polish finish provides corrosion resistance and easy to clean surfaces.
- › Weight (lbs): 16.35

15 PIECE 1/2" DRIVE CROWFOOT WRENCH SET

Product #: **J53001CF**

| Contents | Size (in) | Overall Length (in) |
|----------|-----------|---------------------|
| J5334CF | 1-1/16 | 2-7/8 |
| J5336CF | 1-1/8 | 3 |
| J5338CF | 1-3/16 | 3 |
| J5340CF | 1-1/4 | 3-5/16 |
| J5342CF | 1-5/16 | 3-5/16 |
| J5344CF | 1-3/8 | 3-3/8 |
| J5346CF | 1-7/16 | 3-3/8 |
| J5348CF | 1-1/2 | 3-7/16 |
| J5350CF | 1-9/16 | 3-1/2 |
| J5352CF | 1-5/8 | 3-1/2 |
| J5354CF | 1-11/16 | 3-13/16 |
| J5356CF | 1-3/4 | 3-13/16 |
| J5358CF | 1-13/16 | 3-7/8 |
| J5360CF | 1-7/8 | 3-7/8 |
| J5364CF | 2 | 3-15/16 |



ASME B107.21

- › Crowfoot wrenches are used in hard to reach, restricted access situations where a standard wrench or ratchet cannot reach.
- › Anti-Slip Design open end (ASD).
- › The arched surfaces are designed to spread the contact forces over a greater area and they keep the loads off the corners of the fastener which helps prevent fastener rounding.
- › Broad size range ensures the right tool for the application will be available.
- › Typically used in lower torque applications.
- › Full polish finish provides corrosion resistance and easy to clean surfaces.
- › Weight (lbs): 9.88



1/4" DRIVE FULL POLISH CROWFOOT WRENCHES

- › Crowfoot wrenches are used in hard to reach, restricted access situations where a standard wrench or ratchet cannot reach.
- › Anti-Slip Design Open End (ASD).
- › The arched surfaces are designed to spread the contact forces over a greater area and they keep the loads off the corners of the fastener which helps prevent fastener rounding.
- › Broad size range ensures the right tool for the application will be available.
- › Typically used in lower torque applications.
- › Full Polish finish provides corrosion resistance and easy to clean surfaces.

| Product # | Size (in) | Overall Length (in) | Weight (lbs) |
|----------------|-----------|---------------------|--------------|
| J4708CF | 1/4 | 15/16 | 0.02 |
| J4710CF | 5/16 | 1 | 0.03 |
| J4712CF | 3/8 | 1-1/16 | 0.03 |
| J4714CF | 7/16 | 1-5/32 | 0.04 |
| J4716CF | 1/2 | 1-3/16 | 0.05 |
| J4718CF | 9/16 | 1-9/32 | 0.05 |



ASME B107.21



1/4" DRIVE FULL POLISH METRIC CROWFOOT WRENCHES

METRIC

- › Crowfoot wrenches are used in hard to reach, restricted access situations where a standard wrench or ratchet cannot reach.
- › Anti-Slip Design Open End (ASD).
- › The arched surfaces are designed to spread the contact forces over a greater area and they keep the loads off the corners of the fastener which helps prevent fastener rounding.
- › Broad size range ensures the right tool for the application will be available.
- › Typically used in lower torque applications.
- › Full Polish finish provides corrosion resistance and easy to clean surfaces.

| Product # | Size (mm) | Overall Length (in) | Weight (lbs) |
|-----------------|-----------|---------------------|--------------|
| J4707MCF | 7 | 15/16 | 0.02 |
| J4708MCF | 8 | 31/32 | 0.02 |
| J4710MCF | 10 | 1-1/16 | 0.03 |
| J4711MCF | 11 | 1-1/8 | 0.04 |
| J4712MCF | 12 | 1-5/32 | 0.04 |
| J4713MCF | 13 | 1-3/16 | 0.05 |
| J4714MCF | 14 | 1-1/4 | 0.05 |



ASME B107.21



3/8" DRIVE FULL POLISH CROWFOOT WRENCHES

| Product # | Size (in) | Overall Length (in) | Weight (lbs) |
|-----------|-----------|---------------------|--------------|
| J4912CF | 3/8 | 1-13/64 | 0.06 |
| J4914CF | 7/16 | 1-3/16 | 0.06 |
| J4916CF | 1/2 | 1-5/16 | 0.07 |
| J4918CF | 9/16 | 1-9/32 | 0.07 |
| J4920CF | 5/8 | 1-1/2 | 0.09 |
| J4922CF | 11/16 | 1-31/64 | 0.09 |
| J4924CF | 3/4 | 1-41/64 | 0.11 |
| J4926CF | 13/16 | 1-5/8 | 0.11 |
| J4928CF | 7/8 | 1-19/32 | 0.12 |
| J4930CF | 15/16 | 1-5/8 | 0.13 |
| J4932CF | 1 | 1-49/64 | 0.13 |
| J4934CF | 1-1/16 | 2-3/16 | 0.24 |
| J4936CF | 1-1/8 | 2-7/32 | 0.24 |
| J4938CF | 1-3/16 | 2-9/32 | 0.24 |
| J4940CF | 1-1/4 | 2-5/32 | 0.21 |
| J4942CF | 1-5/16 | 2-1/2 | 0.25 |
| J4944CF | 1-3/8 | 2-1/2 | 0.29 |
| J4946CF | 1-7/16 | 2-5/8 | 0.29 |
| J4948CF | 1-1/2 | 2-11/16 | 0.33 |
| J4950CF | 1-9/16 | 2-3/4 | 0.34 |
| J4952CF | 1-5/8 | 2-13/16 | 0.38 |
| J4954CF | 1-11/16 | 2-15/16 | 0.36 |
| J4956CF | 1-3/4 | 2-15/16 | 0.39 |
| J4958CF | 1-13/16 | 3-1/16 | 0.4 |
| J4960CF | 1-7/8 | 3-1/8 | 0.45 |
| J4962CF | 1-15/16 | 3-1/4 | 0.49 |
| J4964CF | 2 | 3-3/8 | 0.73 |
| J4966CF | 2-1/16 | 3-7/16 | 0.71 |
| J4968CF | 2-1/8 | 3-7/16 | 0.74 |
| J4970CF | 2-3/16 | 3-5/8 | 0.78 |
| J4972CF | 2-1/4 | 3-11/16 | 0.89 |
| J4974CF | 2-5/16 | 3-3/4 | 0.9 |
| J4976CF | 2-3/8 | 3-15/16 | 1.01 |
| J4978CF | 2-7/16 | 4-1/4 | 1.03 |
| J4980CF | 2-1/2 | 4-1/4 | 1.1 |
| J4982CF | 2-9/16 | 4-5/16 | 1.11 |
| J4984CF | 2-5/8 | 4-1/2 | 1.27 |
| J4986CF | 2-11/16 | 4-9/16 | 1.34 |
| J4988CF | 2-3/4 | 4-11/16 | 1.37 |
| J4990CF | 2-13/16 | 4-13/16 | 1.38 |
| J4992CF | 2-7/8 | 4-15/16 | 1.52 |
| J4994CF | 2-15/16 | 4-15/16 | 1.58 |
| J4996CF | 3 | 5 | 1.55 |



ASME B107.21

- › Crowfoot wrenches are used in hard to reach, restricted access situations where a standard wrench or ratchet cannot reach.
- › Anti-Slip Design Open End (ASD).
- › The arched surfaces are designed to spread the contact forces over a greater area and they keep the loads off the corners of the fastener which helps prevent fastener rounding.
- › Broad size range ensures the right tool for the application will be available.
- › Typically used in lower torque applications.
- › Full Polish finish provides corrosion resistance and easy to clean surfaces.
- › Locking hole on 3/8" drive crowfoot wrenches available on fractional openings 1" and larger.



FEATURES AND BENEFITS — ANTI-SLIP DESIGN (ASD)

The Anti-Slip Design consists of two features:

- › A notch to lock the fastener in place.
- › A curve for greater contact area against the fastener.

An ASD Wrench does not apply load to the corners of the fastener, so it helps to prevent rounding. Because of the greater surface contact, the wrench can also successfully apply greater torque without slipping.

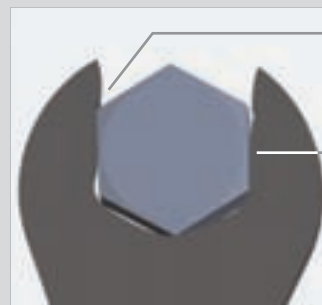

The groove locks the fastener in place.

The curved edge grips the flat of the bolt for a better grip and less rounding.

3/8" DRIVE FULL POLISH METRIC CROWFOOT WRENCHES**METRIC**

- › Crowfoot wrenches are used in hard to reach, restricted access situations where a standard wrench or ratchet cannot reach.
- › Anti-Slip Design Open End (ASD).
- › The arched surfaces are designed to spread the contact forces over a greater area and they keep the loads off the corners of the fastener which helps prevent fastener rounding.
- › Broad size range ensures the right tool for the application will be available.
- › Typically used in lower torque applications.
- › Full Polish finish provides corrosion resistance and easy to clean surfaces.
- › Locking hole feature helps keep the crowfoot wrench engaged on the extension during use reducing downtime due to detachment of crowfoot in awkward spaces.
- › Use with locking extensions to reach into spaces too small for a mechanic's arm or where the fastener is out of site.
- › Locking hole on 3/8" drive crowfoot wrenches available on fractional openings 1" and larger.

| Product # | Size (mm) | Overall Length (in) | Weight (lbs) |
|-----------|-----------|---------------------|--------------|
| J4909MCF | 9 | 1-5/6 | 0.05 |
| J4910MCF | 10 | 1-11/32 | 0.05 |
| J4911MCF | 11 | 1-3/8 | 0.07 |
| J4912MCF | 12 | 1-15/32 | 0.07 |
| J4913MCF | 13 | 1-1/2 | 0.06 |
| J4914MCF | 14 | 1-1/2 | 0.07 |
| J4915MCF | 15 | 1-5/8 | 0.10 |
| J4916MCF | 16 | 1-21/32 | 0.09 |
| J4917MCF | 17 | 1-23/32 | 0.10 |
| J4918MCF | 18 | 1-15/16 | 0.13 |
| J4919MCF | 19 | 1-15/16 | 0.13 |
| J4920MCF | 20 | 2-1/16 | 0.13 |
| J4921MCF | 21 | 2-3/32 | 0.14 |
| J4922MCF | 22 | 2-7/32 | 0.15 |
| J4923MCF | 23 | 2-11/32 | 0.19 |
| J4924MCF | 24 | 2-13/32 | 0.19 |

 ASME B107.21
**1/2" DRIVE FULL POLISH CROWFOOT WRENCHES**

| Product # | Size (in) | Overall Length (in) | Weight (lbs) |
|-----------|-----------|---------------------|--------------|
| J5330CF | 15/16 | 2-13/16 | 0.47 |
| J5332CF | 1 | 2-13/16 | 0.46 |
| J5334CF | 1-1/16 | 2-7/8 | 0.51 |
| J5336CF | 1-1/8 | 3 | 0.54 |
| J5338CF | 1-3/16 | 3 | 0.58 |
| J5340CF | 1-1/4 | 3-5/16 | 0.66 |
| J5342CF | 1-5/16 | 3-5/16 | 0.66 |
| J5344CF | 1-3/8 | 3-3/8 | 0.72 |
| J5346CF | 1-7/16 | 3-3/8 | 0.75 |
| J5348CF | 1-1/2 | 3-7/16 | 0.77 |
| J5350CF | 1-9/16 | 3-1/2 | 0.80 |
| J5352CF | 1-5/8 | 3-1/2 | 0.83 |
| J5354CF | 1-11/16 | 3-13/16 | 0.95 |
| J5356CF | 1-3/4 | 3-13/16 | 0.98 |
| J5358CF | 1-13/16 | 3-7/8 | 1.01 |
| J5360CF | 1-7/8 | 3-7/8 | 1.05 |
| J5364CF | 2 | 3-15/16 | 1.10 |
| J5368CF | 2-1/8 | 4-1/16 | 1.09 |
| J5372CF | 2-1/4 | 4-3/8 | 1.27 |
| J5376CF | 2-3/8 | 4-7/16 | 1.29 |
| J5378CF | 2-7/16 | 4-7/16 | 1.28 |
| J5380CF | 2-1/2 | 4-1/2 | 1.25 |

 ASME B107.21

- › Crowfoot wrenches are used in hard to reach, restricted access situations where a standard wrench or ratchet cannot reach.
- › Anti-Slip Design Open End (ASD).
- › The arched surfaces are designed to spread the contact forces over a greater area and they keep the loads off the corners of the fastener which helps prevent fastener rounding.
- › Broad size range ensures the right tool for the application will be available.
- › Typically used in lower torque applications.
- › Full Polish finish provides corrosion resistance and easy to clean surfaces.
- › Locking hole feature helps keep the crowfoot wrench engaged on the extension during use reducing downtime due to detachment of crowfoot in awkward spaces.
- › Use with locking extensions to reach into spaces too small for a mechanic's arm or where the fastener is out of site.



1/2" DRIVE FULL POLISH METRIC CROWFOOT WRENCHES

METRIC

| Product # | Size (mm) | Overall Length (in) | Weight (lbs) |
|-----------|-----------|---------------------|--------------|
| J5320MCF | 20 | 2-19/32 | 0.43 |
| J5321MCF | 21 | 2-37/64 | 0.43 |
| J5322MCF | 22 | 2-13/16 | 0.45 |
| J5323MCF | 23 | 2-13/16 | 0.47 |
| J5324MCF | 24 | 2-51/64 | 0.47 |
| J5325MCF | 25 | 2-27/32 | 0.48 |
| J5326MCF | 26 | 2-29/32 | 0.49 |
| J5327MCF | 27 | 2-29/32 | 0.51 |
| J5328MCF | 28 | 3 | 0.54 |
| J5329MCF | 29 | 3-1/32 | 0.58 |
| J5330MCF | 30 | 3-1/32 | 0.66 |
| J5332MCF | 32 | 3-19/64 | 0.66 |
| J5335MCF | 35 | 3-23/64 | 0.72 |
| J5336MCF | 36 | 3-13/32 | 0.75 |
| J5338MCF | 38 | 3-7/16 | 0.77 |
| J5341MCF | 41 | 3-1/2 | 0.83 |
| J5342MCF | 42 | 3-51/64 | 0.95 |
| J5346MCF | 46 | 3-55/64 | 1.01 |



ASME B107.21

- › Crowfoot wrenches are used in hard to reach, restricted access situations where a standard wrench or ratchet cannot reach.
- › Anti-Slip Design Open End (ASD).
- › The arched surfaces are designed to spread the contact forces over a greater area and they keep the loads off the corners of the fastener which helps prevent fastener rounding.
- › Broad size range ensures the right tool for the application will be available.
- › Typically used in lower torque applications.
- › Full Polish finish provides corrosion resistance and easy to clean surfaces.
- › Locking hole feature helps keep the crowfoot wrench engaged on the extension during use reducing downtime due to detachment of crowfoot in awkward spaces.
- › Use with locking extensions to reach into spaces too small for a mechanic's arm or where the fastener is out of site.



WRENCHES



CROWFOOT

8 PIECE 3/8" DRIVE FLARE NUT CROWFOOT WRENCH SET

Product #: J4900CFFN

- › Crowfoot wrenches are used in hard to reach, restricted access situations where a standard wrench or ratchet cannot reach.
- › Broad size range ensures the right tool for the application will be available.
- › Typically used in lower torque applications.
- › Full polish finish provides corrosion resistance and easy to clean surfaces.
- › 12 point flare nut end allows for fine indexing, helping to improve speed and access. Fits 4, 6 and 12 point fasteners.
- › Weight (lbs): 1.15

| Contents | Size (in) | Point Count |
|----------|-----------|-------------|
| J4920FL | 5/8 | 12 |
| J4922FL | 11/16 | 12 |
| J4924FL | 3/4 | 12 |
| J4926FL | 13/16 | 12 |
| J4928FL | 7/8 | 12 |
| J4930FL | 15/16 | 12 |
| J4932FL | 1 | 12 |
| J4934FL | 1-1/16 | 12 |



ASME B107.21



39 PIECE 1/2" DRIVE CROWFOOT WRENCH SET

Product #: **J53000CLFN**

| Contents | Size (in) | Point Count | Overall Length (in) |
|----------|-------------------|-------------|---------------------|
| J5330CF | 15/16 | – | 2-13/16 |
| J5332CF | 1 | – | 2-13/16 |
| J5334CF | 1-1/16 | – | 2-7/8 |
| J5336CF | 1-1/8 | – | 3 |
| J5338CF | 1-3/16 | – | 3 |
| J5340CF | 1-1/4 | – | 3-5/16 |
| J5342CF | 1-5/16 | – | 3-5/16 |
| J5344CF | 1-3/8 | – | 3-3/8 |
| J5346CF | 1-7/16 | – | 3-3/8 |
| J5348CF | 1-1/2 | – | 3-7/16 |
| J5350CF | 1-9/16 | – | 3-1/2 |
| J5352CF | 1-5/8 | – | 3-1/2 |
| J5354CF | 1-11/16 | – | 3-13/16 |
| J5356CF | 1-3/4 | – | 3-13/16 |
| J5358CF | 1-13/16 | – | 3-7/8 |
| J5360CF | 1-7/8 | – | 3-7/8 |
| J5364CF | 2 | – | 3-15/16 |
| J5368CF | 2-1/8 | – | 4-1/16 |
| J5372CF | 2-1/4 | – | 4-3/8 |
| J5376CF | 2-3/8 | – | 4-7/16 |
| J5378CF | 2-7/16 | – | 4-7/16 |
| J5380CF | 2-1/2 | – | 4-1/2 |
| J5336FL | 1-1/8 | 12 | 2-13/16 |
| J5338FL | 1-3/16 | 12 | 2-7/8 |
| J5340FL | 1-1/4 | 12 | 3 |
| J5342FL | 1-5/16 | 12 | 3-1/16 |
| J5344FL | 1-3/8 | 12 | 3-5/16 |
| J5346FL | 1-7/16 | 12 | 3-3/8 |
| J5348FL | 1-1/2 | 12 | 3-7/16 |
| J5350FL | 1-9/16 | 12 | 3-9/16 |
| J5352FL | 1-5/8 | 12 | 3-3/4 |
| J5354FL | 1-11/16 | 12 | 3-13/16 |
| J5356FL | 1-3/4 | 12 | 3-7/8 |
| J5358FL | 1-13/16 | 12 | 4 |
| J5360FL | 1-7/8 | 12 | 4-1/4 |
| J5362FL | 1-15/16 | 12 | 4-5/16 |
| J5364FL | 2 | 12 | 4-7/16 |
| J5461L | Locking Extension | – | 5 |
| J5463L | Locking Extension | – | 10 |



ASME B107.21

- › Crowfoot wrenches are used in hard to reach, restricted access situations where a standard wrench or ratchet cannot reach.
- › The arched surfaces are designed to spread the contact forces over a greater area and they keep the loads off the corners of the fastener which helps prevent fastener rounding.
- › 12 point allows for fine indexing, helping to improve speed and access.
- › Fits 4, 6 and 12 point fasteners.
- › Use with locking extensions to reach into small spaces or where the fastener is out of sight.
- › Locking hole feature helps keep the crowfoot wrench engaged on the extension during use, helping to reduce downtime due to the detachment of the crowfoot in an awkward space.
- › Broad size range ensures the right tool for the application will be available.
- › Typically used in lower torque applications.
- › Full polish finish provides corrosion resistance and easy to clean surfaces.
- › Weight (lbs): 23.80



15 PIECE 1/2" DR CROWFOOT FLARE NUT WRENCH SET

Product #: **J5300CFFN**

| Contents | Size (in) | Point Count | Overall Length (in) |
|----------|-----------|-------------|---------------------|
| J5336FL | 1-1/8 | 12 | 2-13/16 |
| J5338FL | 1-3/16 | 12 | 2-7/8 |
| J5340FL | 1-1/4 | 12 | 3 |
| J5342FL | 1-5/16 | 12 | 3-1/16 |
| J5344FL | 1-3/8 | 12 | 3-5/16 |
| J5346FL | 1-7/16 | 12 | 3-3/8 |
| J5348FL | 1-1/2 | 12 | 3-7/16 |
| J5350FL | 1-9/16 | 12 | 3-9/16 |
| J5352FL | 1-5/8 | 12 | 3-3/4 |
| J5354FL | 1-11/16 | 12 | 3-13/16 |
| J5356FL | 1-3/4 | 12 | 3-7/8 |
| J5358FL | 1-13/16 | 12 | 4 |
| J5360FL | 1-7/8 | 12 | 4-1/4 |
| J5362FL | 1-15/16 | 12 | 4-5/16 |
| J5364FL | 2 | 12 | 4-7/16 |



ASME B107.21

- › Crowfoot wrenches are used in hard to reach, restricted access situations where a standard wrench or ratchet cannot reach.
- › 12 point flare nut allows for fine indexing, helping to improve speed and access.
- › Fits 4, 6 and 12 point fasteners.
- › Broad size range ensures the right tool for the application will be available.
- › Typically used in lower torque applications.
- › Full polish finish provides corrosion resistance and easy to clean surfaces.
- › Weight (lbs): 5.86



3/8" DRIVE FULL POLISH FLARE NUT CROWFOOT WRENCHES - 12 POINT

- › Designed for speed and safety.
- › Special heat-treated alloy steel helps increase strength and durability.
- › 12 Point Box end allows for fine indexing, helping to improve speed and access. Fits 4, 6 and 12 point fasteners.
- › Full Polish finish provides corrosion resistance and easy to clean surfaces.
- › Locking hole helps hold crowfoot in place during use.
- › Use with a locking extension to help prevent tool loss in awkward locations.



| Product # | Size (in) | Outside Head Width (in) (C) | Head Thickness (in) (D) | Offset Height (in) (E) | Weight (lbs) |
|----------------|-----------|-----------------------------|-------------------------|------------------------|--------------|
| J4920FL | 5/8 | 63/64 | 11/16 | 3/4 | 0.09 |
| J4922FL | 11/16 | 1-3/64 | 11/16 | 51/64 | 0.10 |
| J4924FL | 3/4 | 1-11/64 | 23/32 | 27/32 | 0.12 |
| J4926FL | 13/16 | 1-1/16 | 23/32 | 57/64 | 0.12 |
| J4928FL | 7/8 | 1-11/32 | 3/4 | 63/64 | 0.16 |
| J4930FL | 15/16 | 1-27/64 | 3/4 | 61/64 | 0.17 |
| J4932FL | 1 | 1-1/2 | 25/32 | 1-1/32 | 0.18 |
| J4934FL | 1-1/16 | 1-37/64 | 25/32 | 1-1/16 | 0.20 |



ASME B107.21

3/8" DRIVE FULL POLISH FLARE NUT CROWFOOT WRENCHES - 6 POINT

- › Flare Nut Crowfoot wrenches are used in hard to reach or restricted access situations where a standard flare nut wrench cannot reach.
- › The flare nut slot opening is used to slide over hydraulic lines or other hoses which allows for easy access to hex connectors at ends.
- › Typically used in low torque applications.
- › Full polish finish provides corrosion resistance and easy to clean surfaces.
- › Locking hole feature helps keep the crowfoot engaged on the extension during use, helping to reduce downtime and improve working efficiency.
- › Use with locking extensions to reach into small spaces where the fastener is out of sight.

| Product # | Size (in) | Overall Length (in) | Weight (lbs) |
|-----------|-----------|---------------------|--------------|
| J4912HFL | 3/8 | 1-13/16 | 0.07 |
| J4914HFL | 7/16 | 1-1/2 | 0.08 |
| J4916HFL | 1/2 | 1-5/8 | 0.10 |
| J4918HFL | 9/16 | 1-5/8 | 0.11 |
| J4920HFL | 5/8 | 1-3/4 | 0.13 |
| J4922HFL | 11/16 | 1-13/16 | 0.13 |
| J4924HFL | 3/4 | 1-15/16 | 0.16 |
| J4926HFL | 13/16 | 2 | 0.18 |



ASME B107.21



3/8" DRIVE FULL POLISH METRIC FLARE NUT CROWFOOT WRENCHES - 6 POINT

METRIC

- › Flare Nut Crowfoot wrenches are used in hard to reach or restricted access situations where a standard flare nut wrench cannot reach.
- › The flare nut slot opening is used to slide over hydraulic lines or other hoses which allows for easy access to hex connectors at ends.
- › Typically used in low torque applications.
- › Full polish finish provides corrosion resistance and easy to clean surfaces.
- › Locking hole feature helps keep the crowfoot engaged on the extension during use, helping to reduce downtime and improve working efficiency.
- › Use with locking extensions to reach into small spaces where the fastener is out of sight.

| Product # | Size (mm) | Overall Length (in) | Weight (lbs) |
|-----------|-----------|---------------------|--------------|
| J4909MHFL | 9 | 1-5/16 | 0.07 |
| J4910MHFL | 10 | 1-3/8 | 0.07 |
| J4911MHFL | 11 | 1-1/2 | 0.08 |
| J4912MHFL | 12 | 1-1/2 | 0.08 |
| J4913MHFL | 13 | 1-9/16 | 0.09 |
| J4914MHFL | 14 | 1-5/8 | 0.11 |
| J4915MHFL | 15 | 1-11/16 | 0.11 |
| J4916MHFL | 16 | 1-3/4 | 0.12 |
| J4917MHFL | 17 | 1-3/4 | 0.13 |
| J4918MHFL | 18 | 1-13/16 | 0.14 |



ASME B107.21



1/2" DRIVE FULL POLISH FLARE NUT CROWFOOT WRENCHES - 12 POINT

| Product # | Size (in) | Overall Length (in) | Weight (lbs) |
|-----------|-----------|---------------------|--------------|
| J5336FL | 1-1/8 | 2-13/16 | 0.19 |
| J5338FL | 1-3/16 | 2-7/8 | 0.19 |
| J5340FL | 1-1/4 | 3 | 0.19 |
| J5342FL | 1-5/16 | 3-1/16 | 0.19 |
| J5344FL | 1-3/8 | 3-5/16 | 0.25 |
| J5346FL | 1-7/16 | 3-3/8 | 0.25 |
| J5348FL | 1-1/2 | 3-7/16 | 0.25 |
| J5350FL | 1-9/16 | 3-9/16 | 0.31 |
| J5352FL | 1-5/8 | 3-3/4 | 0.31 |
| J5354FL | 1-11/16 | 3-13/16 | 0.31 |
| J5356FL | 1-3/4 | 3-7/8 | 0.38 |
| J5358FL | 1-13/16 | 4 | 0.38 |
| J5360FL | 1-7/8 | 4-1/4 | 0.45 |
| J5362FL | 1-15/16 | 4-5/16 | 0.5 |
| J5364FL | 2 | 4-7/16 | 0.5 |

 ASME B107.21

- › Designed for speed and safety.
- › Special heat-treated alloy steel helps increase strength and durability.
- › 12 Point Box end allows for fine indexing, helping to improve speed and access. Fits 4, 6 and 12 point fasteners.
- › Full Polish finish provides corrosion resistance and easy to clean surfaces.



7 PIECE COMBINATION FLARE NUT WRENCH SET - 6 POINT

Product #: J3700A

| Contents | Size (in) | Point Count | Overall Length (in) |
|----------|-----------|-------------|---------------------|
| J3751 | 3/8 | 6 | 5-11/16 |
| J3752 | 7/16 | 6 | 6-1/32 |
| J3753 | 1/2 | 6 | 6-7/16 |
| J3754 | 9/16 | 6 | 6-15/16 |
| J3755 | 5/8 | 6 | 7-5/8 |
| J3756 | 11/16 | 6 | 8-11/16 |
| J3757 | 3/4 | 6 | 9-3/16 |
| J25TR03C | Tool Roll | | |

 ASME B107.21

- › Satin finish provides corrosion resistance and a slip-resistant grip.
- › Flare nut box end incorporates the TorquePlus™ system.
- › Weight (lbs): 2.24



7 PIECE COMBINATION FLARE NUT WRENCH SET - 12 POINT

Product #: J3700AT

| Contents | Size (in) | Point Count | Overall Length (in) |
|----------|-----------|-------------|---------------------|
| J3751T | 3/8 | 12 | 5-11/16 |
| J3752T | 1/2 | 12 | 6-1/32 |
| J3753T | 7/16 | 12 | 6-7/16 |
| J3754T | 9/16 | 12 | 6-15/16 |
| J3755T | 5/8 | 12 | 7-5/8 |
| J3756T | 11/16 | 12 | 8-11/16 |
| J3757T | 3/4 | 12 | 9-3/16 |
| J25TR03C | Tool Roll | | |

 ASME B107.21

- › Satin finish provides corrosion resistance and a slip-resistant grip.
- › 12 point flare nut box end allows for fine indexing, helping to improve speed and access.
- › Fits 4, 6 and 12 point fasteners.
- › Flare nut box end incorporates the TorquePlus™ system.
- › Weight (lbs): 2.24



SATIN COMBINATION FLARE NUT WRENCHES - 6 POINT

- › Satin finish provides corrosion resistance and a slip-resistant grip.
- › Flare nut box end incorporates the TorquePlus™ system.



| Product # | Size (in) (A) | Throat Depth (in) (B) | Outside Head Width (in) (C) | Head Thickness (in) (D) | Throat Depth (in) (B1) | Outside Head Width (in) (C1) | Head Thickness (in) (D1) | Overall Length (in) | Weight (lbs) |
|-----------|---------------|-----------------------|-----------------------------|-------------------------|------------------------|------------------------------|--------------------------|---------------------|--------------|
| J3751 | 3/8 | 7/16 | 25/32 | 11/32 | 19/64 | 51/64 | 23/65 | 5-11/16 | 0.12 |
| J3752 | 7/16 | 33/64 | 7/8 | 3/8 | 23/64 | 59/64 | 13/32 | 6-1/32 | 0.16 |
| J3753 | 1/2 | 19/32 | 31/32 | 3/8 | 25/64 | 1-1/32 | 13/32 | 6-7/16 | 0.21 |
| J3754 | 9/16 | 43/64 | 1-3/64 | 7/16 | 26/64 | 1-11/64 | 15/32 | 6-15/16 | 0.34 |
| J3755 | 5/8 | 47/64 | 1-3/32 | 7/16 | 33/64 | 1-9/64 | 15/32 | 7-5/8 | 0.45 |
| J3756 | 11/16 | 51/64 | 1-3/16 | 1/2 | 9/16 | 1-13/32 | 17/32 | 8-11/16 | 0.45 |
| J3757 | 3/4 | 57/64 | 1-7/32 | 1/2 | 9/16 | 1-9/16 | 17/32 | 9-3/16 | 0.49 |

ASME B107.100

SATIN COMBINATION FLARE NUT WRENCHES - 12 POINT

- › Satin finish provides corrosion resistance and a slip-resistant grip.
- › 12 point flare nut box end allows for fine indexing, helping to improve speed and access.
- › Fits 4, 6 and 12 point fasteners.
- › Flare nut box end incorporates the TorquePlus™ system.



| Product # | Size (in) (A) | Throat Depth (in) (B) | Outside Head Width (in) (C) | Head Thickness (in) (D) | Throat Depth (in) (B1) | Outside Head Width (in) (C1) | Head Thickness (in) (D1) | Overall Length (in) | Weight (lbs) |
|-----------|---------------|-----------------------|-----------------------------|-------------------------|------------------------|------------------------------|--------------------------|---------------------|--------------|
| J3751T | 3/8 | 7/16 | 25/32 | 11/32 | 19/64 | 51/64 | 3/8 | 5-11/16 | 0.13 |
| J3752T | 1/2 | 33/64 | 7/8 | 3/8 | 23/64 | 29/32 | 13/32 | 6-1/32 | 0.18 |
| J3753T | 7/16 | 19/32 | 31/32 | 3/8 | 25/64 | 1-1/32 | 13/32 | 6-7/16 | 0.19 |
| J3754T | 9/16 | 43/64 | 1-3/64 | 7/16 | 29/64 | 1-3/64 | 15/32 | 6-15/16 | 0.25 |
| J3755T | 5/8 | 47/64 | 1-3/32 | 7/16 | 33/64 | 1-19/64 | 15/32 | 7-5/8 | 0.32 |
| J3756T | 11/16 | 51/64 | 1-3/16 | 1/2 | 9/16 | 1-13/32 | 17/32 | 8-11/16 | 0.42 |
| J3757T | 3/4 | 57/64 | 1-7/32 | 1/2 | 9/16 | 1-9/16 | 17/32 | 9-3/16 | 0.46 |

ASME B107.100

3 PIECE DOUBLE END FLARE NUT WRENCH SET - 6 POINT

Product #: J3760

- › Satin finish provides corrosion resistance and a slip-resistant grip.
- › Flare nut box ends incorporate the TorquePlus™ system.
- › Weight (lbs): 0.97



| Contents | Size (in) | Point Count | Overall Length (in) |
|----------|-------------|-------------|---------------------|
| J3764 | 3/8 x 7/16 | 6 | 6-1/4 |
| J3768 | 1/2 x 9/16 | 6 | 7-1/2 |
| J3772 | 5/8 x 11/16 | 6 | 8-3/4 |
| J25TR17C | Tool Roll | | |

ASME B107.100



5 PIECE METRIC DOUBLE END FLARE NUT WRENCH SET - 6 POINT

Product #: **J3700M**

METRIC

- › Satin finish provides corrosion resistance and a slip-resistant grip.
- › Flare nut box ends incorporates the TorquePlus™ system.
- › Weight (lbs): 1.25



| Contents | Size (mm) | Point Count | Overall Length (in) |
|----------|-----------|-------------|---------------------|
| J3707M | 7 x 8 | 6 | 5-11/16 |
| J3709M | 9 x 11 | 6 | 6-5/16 |
| J3710M | 10 x 12 | 6 | 6-15/16 |
| J3713M | 13 x 14 | 6 | 7-9/16 |
| J3715M | 15 x 17 | 6 | 7-63/64 |
| J25TR06C | Tool Roll | | |

ASME B107.100



WRENCHES



3 PIECE DOUBLE END FLARE NUT WRENCH SET - 12 POINT

Product #: **J3760T**

- › Satin finish provides corrosion resistance and a slip-resistant grip.
- › 12 point flare nut box end allows for fine indexing, helping to improve speed and access.
- › Fits 4, 6 and 12 point fasteners.
- › Flare nut box ends incorporate the TorquePlus™ system.
- › Weight (lbs): 0.97



| Contents | Size (in) | Point Count | Overall Length (in) |
|----------|-------------|-------------|---------------------|
| J3764T | 3/8 x 7/16 | 12 | 6-1/4 |
| J3768T | 1/2 x 9/16 | 12 | 7-1/2 |
| J3772T | 5/8 x 11/16 | 12 | 8-3/4 |
| J25TR17C | Tool Roll | | |

ASME B107.100



FLARE NUT

5 PIECE METRIC DOUBLE END FLARE NUT WRENCH SET - 12 POINT

Product #: **J3700MT**

METRIC

- › Satin finish provides corrosion resistance and a slip-resistant grip.
- › 12 point flare nut box end allows for fine indexing, helping to improve speed and access.
- › Fits 4, 6 and 12 point fasteners.
- › Flare nut ends incorporate the TorquePlus™ system.
- › Weight (lbs): 1.29



| Contents | Size (in) | Point Count | Overall Length (in) |
|----------|-----------|-------------|---------------------|
| J3707MT | 7 x 8 | 12 | 5-11/16 |
| J3709MT | 9 x 11 | 12 | 6-5/16 |
| J3710MT | 10 x 12 | 12 | 6-15/16 |
| J3713MT | 13 x 14 | 12 | 7-9/16 |
| J3715MT | 15 x 17 | 12 | 7-63/64 |
| J25TR06C | Tool Roll | | |

ASME B107.100



SATIN DOUBLE END FLARE NUT WRENCHES - 6 POINT

- › Satin finish provides corrosion resistance and a slip-resistant grip.
- › Flare nut box ends incorporate the TorquePlus™ system.



| Product # | Size (in) | Mouth Width (in) (A) | Outside Head Width (in) (C) | Head Thickness (in) (D) | Mouth Width (in) (A1) | Outside Head Width (in) (C1) | Head Thickness (in) (D1) | Overall Length (in) | Weight (lbs) |
|-----------|-------------|----------------------|-----------------------------|-------------------------|-----------------------|------------------------------|--------------------------|---------------------|--------------|
| J3764 | 3/8 x 7/16 | 19/64 | 51/64 | 11/32 | 23/64 | 57/64 | 3/8 | 6-1/4 | 0.18 |
| J3768 | 1/2 x 9/16 | 25/64 | 31/32 | 3/8 | 13/32 | 1-3/64 | 7/16 | 7-1/2 | 0.27 |
| J3772 | 5/8 x 11/16 | 33/64 | 1-7/64 | 7/16 | 37/64 | 1-13/64 | 31/64 | 8-3/4 | 0.38 |



ASME B107.100

SATIN METRIC DOUBLE END FLARE NUT WRENCHES - 6 POINT

- › Satin finish provides corrosion resistance and a slip-resistant grip.
- › Flare nut box ends incorporate the TorquePlus™ system.



METRIC



| Product # | Size (mm) | Mouth Width (in) (A) | Outside Head Width (in) (C) | Head Thickness (in) (D) | Mouth Width (in) (A1) | Outside Head Width (in) (C1) | Head Thickness (in) (D1) | Overall Length (in) | Weight (lbs) |
|-----------|-----------|----------------------|-----------------------------|-------------------------|-----------------------|------------------------------|--------------------------|---------------------|--------------|
| J3707M | 7 x 8 | 7/32 | 43/64 | 19/64 | 15/64 | 3/4 | 21/64 | 5-11/16 | 0.12 |
| J3709M | 9 x 11 | 9/32 | 13/16 | 23/64 | 11/32 | 29/32 | 25/64 | 6-5/16 | 0.17 |
| J3710M | 10 x 12 | 9/32 | 55/64 | 25/64 | 11/32 | 61/64 | 25/64 | 6-15/16 | 0.22 |
| J3713M | 13 x 14 | 3/8 | 1-1/64 | 25/64 | 7/16 | 1-3/32 | 29/64 | 7-9/16 | 0.26 |
| J3715M | 15 x 17 | 7/16 | 1-7/64 | 29/64 | 1/2 | 1-3/16 | 31/64 | 7-63/64 | 0.37 |
| J3716M | 16 x 18 | 1/2 | 1-9/64 | 29/64 | 37/64 | 1-15/64 | 33/64 | 8-13/16 | 0.39 |
| J3719M | 19 x 21 | 37/64 | 1-9/32 | 35/64 | 5/8 | 1-3/8 | 37/64 | 9-3/8 | 0.6 |



ASME B107.100

SATIN DOUBLE END FLARE NUT WRENCHES - 12 POINT

- › Satin finish provides corrosion resistance and a slip-resistant grip.
- › 12 point flare nut box end allows for fine indexing, helping to improve speed and access.
- › Fits 4, 6 and 12 point fasteners.
- › Flare nut box ends incorporate the TorquePlus™ system.



| Product # | Size (in) | Mouth Width (in) (A) | Outside Head Width (in) (C) | Head Thickness (in) (D) | Mouth Width (in) (A1) | Outside Head Width (in) (C1) | Head Thickness (in) (D1) | Overall Length (in) | Weight (lbs) |
|-----------|-------------|----------------------|-----------------------------|-------------------------|-----------------------|------------------------------|--------------------------|---------------------|--------------|
| J3764T | 3/8 x 7/16 | 19/64 | 51/64 | 11/32 | 23/64 | 57/64 | 3/8 | 6-1/4 | 0.18 |
| J3768T | 1/2 x 9/16 | 25/64 | 31/32 | 3/8 | 13/32 | 1-1/16 | 7/16 | 7-1/2 | 0.27 |
| J3772T | 5/8 x 11/16 | 33/64 | 1-7/64 | 7/16 | 37/64 | 1-13/64 | 31/64 | 8-3/4 | 0.38 |



ASME B107.100



SATIN METRIC DOUBLE END FLARE NUT WRENCHES - 12 POINT

METRIC

- › Satin finish provides corrosion resistance and a slip-resistant grip.
- › Flare nut box ends incorporate the TorquePlus™ system.
- › 12 point flare nut box end allows for fine indexing, helping to improve speed and access.
- › Fits 4, 6 and 12 point fasteners.



| Product # | Size (mm) | Mouth Width (in) (A) | Outside Head Width (in) (C) | Head Thickness (in) (D) | Mouth Width (in) (A1) | Outside Head Width (in) (C1) | Head Thickness (in) (D1) | Overall Length (in) | Weight (lbs) |
|-----------|-----------|----------------------|-----------------------------|-------------------------|-----------------------|------------------------------|--------------------------|---------------------|--------------|
| J3707MT | 7 x 8 | 7/32 | 43/64 | 19/64 | 15/64 | 3/4 | 21/64 | 5-11/16 | 0.11 |
| J3709MT | 9 x 11 | 9/32 | 13/16 | 23/64 | 11/32 | 29/32 | 25/64 | 6-5/16 | 0.16 |
| J3710MT | 10 x 12 | 9/32 | 55/64 | 25/64 | 11/32 | 61/64 | 25/64 | 6-15/16 | 0.21 |
| J3713MT | 13 x 14 | 3/8 | 1-1/64 | 25/64 | 7/16 | 1-3/32 | 29/64 | 7-9/16 | 0.24 |
| J3715MT | 15 x 17 | 7/16 | 1-7/64 | 29/64 | 1/2 | 1-3/16 | 31/64 | 7-63/64 | 0.33 |
| J3716MT | 16 x 18 | 1/2 | 1-9/64 | 29/64 | 37/64 | 1-15/64 | 33/64 | 8-13/16 | 0.36 |
| J3719MT | 19 x 21 | 37/64 | 1-9/32 | 35/64 | 5/8 | 1-3/8 | 37/64 | 9-7/16 | 0.39 |



ASME B107.100

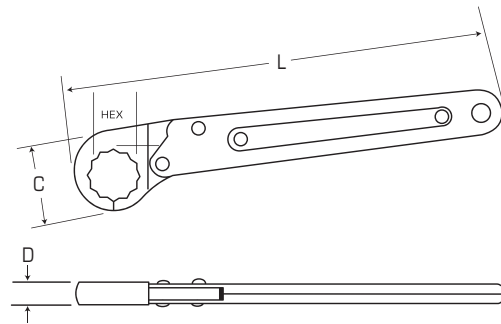
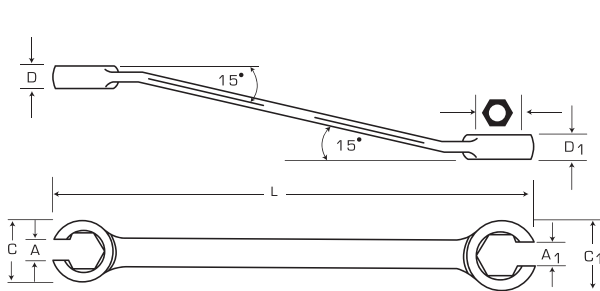

7 PIECE RATCHETING FLARE NUT WRENCH SET - 12 POINT

Product #: J3800A

- › Black oxide finish.
- › Non-reflective black oxide finish for use where non-plated products are required.
- › 12 Point flare nut box end allows for fine indexing, helping to improve speed and access.
- › Pivoting head allows user to place the wrench over the connected pipes to reach the fastener.
- › Weight (lbs): 1.93

| Contents | Size (in) | Point Count | Overall Length (in) |
|----------|-----------|-------------|---------------------|
| J3812 | 3/8 | 12 | 5-7/16 |
| J3814 | 7/16 | 12 | 5-7/16 |
| J3816 | 1/2 | 12 | 5-7/16 |
| J3818 | 9/16 | 12 | 7-1/4 |
| J3820 | 5/8 | 12 | 7-1/4 |
| J3822 | 11/16 | 12 | 7-1/4 |
| J3824 | 3/4 | 12 | 7-1/4 |
| J25TR03C | Tool Roll | | |



BLACK OXIDE RATCHETING FLARE NUT WRENCHES - 12 POINT

- › Black oxide finish.
- › Non-reflective black oxide finish for use where non-plated products are required.
- › 12 Point flare nut box end allows for fine indexing, helping to improve speed and access.
- › Pivoting head allows user to place the wrench over the connected pipes to reach the fastener.



| Product # | Size (in) | Outside Head Width (in) (C) | Head Thickness (in) (D) | Overall Length (in) | Weight (lbs) |
|--------------|-----------|-----------------------------|-------------------------|---------------------|--------------|
| J3812 | 3/8 | 1 | 9/32 | 5-7/16 | 0.17 |
| J3814 | 7/16 | 1 | 9/32 | 5-7/16 | 0.17 |
| J3816 | 1/2 | 1 | 9/32 | 5-7/16 | 0.17 |
| J3818 | 9/16 | 1-5/16 | 3/8 | 7-1/4 | 0.31 |
| J3820 | 5/8 | 1-5/16 | 3/8 | 7-1/4 | 0.31 |
| J3822 | 11/16 | 1-5/16 | 3/8 | 7-1/4 | 0.31 |
| J3824 | 3/4 | 1-5/16 | 3/8 | 7-1/4 | 0.31 |
| J3826 | 13/16 | 1-11/16 | 7/16 | 9-3/8 | 0.58 |
| J3828 | 7/8 | 1-11/16 | 7/16 | 9-3/8 | 0.58 |
| J3830 | 15/16 | 1-11/16 | 1/2 | 9-3/8 | 0.58 |
| J3832 | 1 | 1-11/16 | 1/2 | 9-3/8 | 0.58 |

BLACK OXIDE BOX END SPUD WRENCHES - 12 POINT

- › Non-reflective black oxide finish for use where non-plated products are required.
- › Ideal for heavy construction and field service work.
- › High leverage handle and strong box end designed to turn stubborn nuts and bolts.
- › Tapered spud end aligns flange holes.
- › 12 point box end allows for fine indexing helping to improve speed and access. Fits 4, 6 and 12 point fasteners.



| Product # | Size (in) | Outside Head Width (in) (C) | Head Thickness (in) (D) | Offset Height (in) (E) | Overall Length (in) | Weight (lbs) |
|--------------|-----------|-----------------------------|-------------------------|------------------------|---------------------|--------------|
| J2613 | 13/16 | 1-11/32 | 5/8 | 1-3/32 | 12 | 0.87 |
| J2614 | 7/8 | 1-11/32 | 5/8 | 1-3/32 | 14-1/2 | 0.85 |
| J2615 | 15/16 | 1-11/32 | 5/8 | 1-3/32 | 13-1/2 | 1.25 |
| J2616 | 1 | 1-9/16 | 11/16 | 1-5/16 | 1-1/2 | 1.22 |
| J2617 | 1-1/16 | 1-19/32 | 11/16 | 1-5/16 | 15 | 1.57 |
| J2618 | 1-1/8 | 1-45/64 | 13/16 | 1-1/16 | 15 | 1.50 |
| J2620 | 1-1/4 | 1-25/32 | 13/16 | 1-1/16 | 17 | 2.38 |
| J2621 | 1-5/16 | 2-1/8 | 15/16 | 1-3/8 | 17-3/32 | 2.19 |
| J2623 | 1-7/16 | 2-1/8 | 15/16 | 1-3/8 | 21-5/16 | 3.10 |
| J2624 | 1-1/2 | 2-3/16 | 1 | 1-1/2 | 21-3/16 | 3.05 |
| J2626 | 1-5/8 | 2-15/32 | 1-1/8 | 1-1/2 | 22-3/32 | 4.70 |
| J2627 | 1-11/16 | 2-15/32 | 1-1/8 | 1-1/2 | 22-5/16 | 4.91 |
| J2629 | 1-13/16 | 2-29/32 | 1-3/16 | 1-9/16 | 23-5/16 | 5.84 |
| J2630 | 1-7/8 | 2-29/32 | 1-3/16 | 1-9/16 | 23 | 5.99 |
| J2632 | 2 | 3-5/32 | 1-7/16 | 1-21/32 | 24 | 7.04 |
| J2635 | 2-3/16 | 3-15/32 | 1-9/16 | 1-7/8 | 26 | 8.93 |
| J2638 | 2-3/8 | 3-23/32 | 1-1/2 | 2 | 28 | 9.96 |
| J2641 | 2-9/16 | 4 | 1-1/2 | 2-1/4 | 29 | 11.24 |
| J2644 | 2-3/4 | 4 | 1-1/2 | 2-1/4 | 30 | 14.34 |

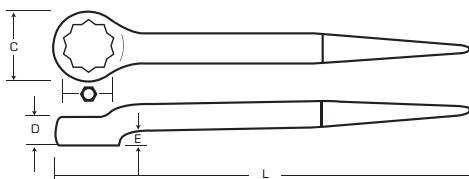

BLACK OXIDE OPEN END SPUD WRENCHES - OFFSET HEAD

- › Non-reflective black oxide finish for use where non-plated products are required.
- › Long offset handle provides greater leverage and clearance for knuckles and obstructions.
- › Hardened tapered handle aligns bolt and rivet holes.
- › Openings are precision broached for proper fit.



| Product # | Size (in) | Outside Head Width (in) (C) | Head Thickness (in) (D) | Offset Height (in) (E) | Overall Length (in) | Weight (lbs) |
|-----------|-----------|-----------------------------|-------------------------|------------------------|---------------------|--------------|
| JC901B | 9/16 | 1-9/16 | 7/16 | 3/4 | 11-1/2 | 0.76 |
| JC903A | 5/8 | 1-9/16 | 7/16 | 3/4 | 12 | 0.76 |
| JC903 | 11/16 | 1-9/16 | 7/16 | 3/4 | 11-13/16 | 0.77 |
| JC904A | 3/4 | 1-7/8 | 7/16 | 3/4 | 11-13/16 | 0.76 |
| JC905A | 13/16 | 2 | 9/16 | 7/8 | 14-1/2 | 1.29 |
| JC905 | 7/8 | 2-3/16 | 9/16 | 7/8 | 14-1/2 | 1.23 |
| JC906C | 15/16 | 2-3/16 | 9/16 | 7/8 | 14-1/2 | 1.30 |
| JC906B | 1 | 2-3/16 | 9/16 | 7/8 | 14-3/16 | 1.29 |
| JC907 | 1-1/16 | 2-7/16 | 21/32 | 1 | 17-3/16 | 1.88 |
| JC907A | 1-1/8 | 2-7/16 | 21/32 | 1 | 16-11/16 | 1.79 |
| JC908 | 1-1/4 | 2-3/4 | 13/16 | 1-1/4 | 19 | 2.78 |
| JC908A | 1-5/16 | 2-3/4 | 13/16 | 1-1/4 | 19-3/32 | 2.79 |
| JC909 | 1-7/16 | 3-1/8 | 13/16 | 1-1/4 | 20 | 3.54 |
| JC909A | 1-1/2 | 3-1/8 | 13/16 | 1-1/4 | 20 | 3.79 |
| JC910 | 1-5/8 | 3-1/8 | 13/16 | 1-5/8 | 23 | 5.68 |
| JC910A | 1-11/16 | 3-5/8 | 13/16 | 1-5/8 | 22-13/16 | 5.41 |
| JC911 | 1-13/16 | 4-1/8 | 13/16 | 1-5/8 | 24 | 7.35 |
| JC911A | 1-7/8 | 4-1/8 | 13/16 | 1-5/8 | 24 | 7.23 |
| JC912 | 2 | 4-7/16 | 13/16 | 1-5/8 | 24 | 7.5 |

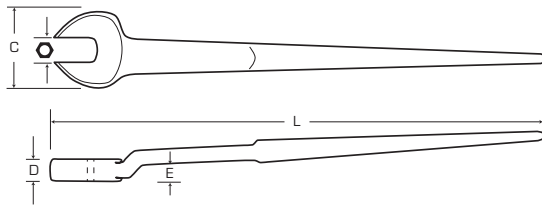

BLACK OXIDE ADJUSTABLE SPUD WRENCH

- › Non-Reflective black oxide finish for use where none plated products are required.
- › Large jaw opening fits all nuts and bolts up to 1-1/2 inches.
- › Square jaw opening provides strength and tight fit.
- › Eliminates the need for carrying several fixed size wrenches.
- › Hardened taper handle aligns bolt and rivet holes.



| Product # | Max Opening Overall Length | | Weight (lbs) |
|-----------|----------------------------|---------|--------------|
| | (in) | (in) | |
| J712SC | 1-1/2 | 16-3/32 | 2.45 |

BLACK OXIDE SPUD HANDLE 1/2" DRIVE PEAR HEAD RATCHET

- › Tapered handle for aligning bolt holes.
- › Spring-loaded pellet in male drive plug.
- › Black oxide finish.

| Product # | Overall Length (in) | Weight (lbs) |
|------------|---------------------|--------------|
| J5449-14BL | 14 | 2.03 |



ASME B107.500

BLACK OXIDE HEAVY-DUTY STRIKING WRENCHES - 6 POINT

- › Non-reflective black oxide finish for use where non-plated products are required.
- › Large striking surface for surer blow contact and more efficient transmittal of force to fastener.
- › Short handle permits use in close quarters.
- › Box opening designed to remain on fastener when wrench is struck.
- › For use where extreme force is necessary to loosen or set large fasteners.
- › Heavy box walls provide greater torque transmission.
- › Straight handle design helps prevent the wrench from cocking when struck.



| Product # | Size (in) | Outside Head Width (in) (C) | Head Thickness (in) (D) | Overall Length (in) | Weight (lbs) |
|-----------|-----------|-----------------------------|-------------------------|---------------------|--------------|
| J2717SW | 1-1/16 | 1-25/32 | 5/8 | 9-7/8 | 1.62 |
| J2720SW | 1-1/4 | 2 | 23/32 | 10-1/4 | 1.72 |
| J2723SW | 1-7/16 | 2-17/64 | 7/8 | 10-19/32 | 2.49 |
| J2726SW | 1-5/8 | 2-31/64 | 61/64 | 10-15/16 | 3.17 |
| J2729SW | 1-13/16 | 2-21/32 | 63/64 | 11-5/16 | 3.49 |
| J2732SW | 2 | 3-1/32 | 1-7/32 | 11-21/32 | 4.73 |
| J2735SW | 2-3/16 | 3-9/32 | 1-15/64 | 11-5/16 | 5.33 |
| J2738SW | 2-3/8 | 3-13/32 | 1-7/16 | 12-3/8 | 5.63 |
| J2741SW | 2-9/16 | 3-3/4 | 1-17/32 | 12-11/16 | 6.47 |
| J2744SW | 2-3/4 | 4-11/64 | 1-17/32 | 12-13/16 | 7.56 |
| J2747SW | 2-15/16 | 4-23/64 | 1-17/32 | 13-5/16 | 7.81 |
| J2750SW | 3-1/8 | 4-31/64 | 1-41/64 | 13-11/16 | 9.50 |
| J2756SW | 3-1/2 | 4-31/32 | 1-23/32 | 13-29/32 | 10.54 |
| J2762SW | 3-7/8 | 5-35/64 | 1-23/32 | 14-13/32 | 12.76 |

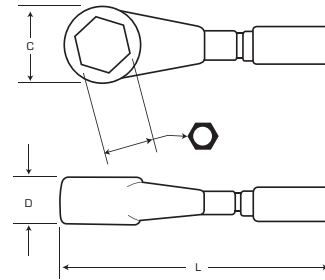
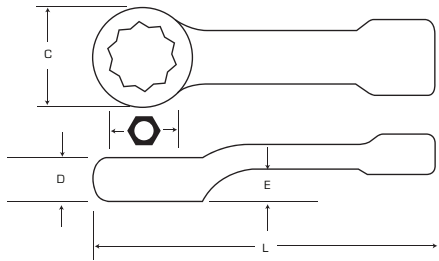

BLACK OXIDE HEAVY-DUTY STRIKING WRENCHES - 12 POINT

- › Non-reflective black oxide finish for use where non-plated products are required.
- › 12 point box end allows for fine indexing, helping improve speed and access.
- › Fits most 4, 6 and 12 point fasteners.
- › Large striking surface for surer blow contact and more efficient transmittal of force to fastener.
- › Short handle permits use in close quarters.
- › Box opening designed to remain on fastener when wrench is struck.
- › For use where extreme force is necessary to loosen or set large fasteners.
- › Heavy box walls provide greater torque transmission.
- › Straight handle design helps prevent the wrench from cocking when struck.



| Product # | Size (in) | Outside Head Width (in) (C) | Head Thickness (in) (D) | Overall Length (in) | Weight (lbs) |
|-----------|-----------|-----------------------------|-------------------------|---------------------|--------------|
| JSN16 | 1 | 1-25/32 | 5/8 | 9-7/8 | 1.90 |
| JSN17 | 1-1/16 | 1-25/32 | 5/8 | 9-7/8 | 1.90 |
| JSN18 | 1-1/8 | 1-25/32 | 5/8 | 9-7/8 | 1.90 |
| JSN19 | 1-3/16 | 2 | 3/4 | 10-1/4 | 2.10 |
| JSN20 | 1-1/4 | 2 | 3/4 | 10-1/4 | 2.10 |



BLACK OXIDE HEAVY-DUTY OFFSET STRIKING WRENCHES - 12 POINT

- › Black oxide finish.
- › Large striking surface for surer blow contact and more efficient transmittal of force to fastener.
- › Short handle permits use in close quarters.
- › Box opening designed to remain on fastener when wrench is struck.
- › For use where extreme force is necessary to loosen or set large fasteners.
- › Heavy box walls provide greater torque transmission.
- › Offset handle clears obstructions.



| Product # | Size (in) | Size (mm) | Outside Head Width (in) (C) | Head Thickness (in) (D) | Offset Height (in) (E) | Overall Length (in) | Weight (lbs) |
|-----------|-----------|-----------|-----------------------------|-------------------------|------------------------|---------------------|--------------|
| J2616SW | 1 | | 1-25/32 | 5/8 | 15/16 | 8-1/2 | 1.84 |
| J2617SW | 1-1/16 | 27 | 1-11/16 | 5/8 | 15/16 | 8-1/2 | 1.84 |
| J2618SW | 1-1/8 | | 1-11/16 | 5/8 | 15/16 | 11 | 1.79 |
| J2619SW | 1-3/16 | 30 | 2-1/16 | 13/16 | 13/16 | 10-3/4 | 2.55 |
| J2620SW | 1-1/4 | | 1-7/8 | 13/16 | 13/16 | 10-3/4 | 2.58 |
| J2621SW | 1-5/16 | | 1-7/8 | 13/16 | 13/16 | 11-1/2 | 2.59 |
| J2622SW | 1-3/8 | 35 | 2-25/64 | 1 | 1-1/2 | 12 | 3.40 |
| J2623SW | 1-7/16 | | 2-3/16 | 1 | 1-1/2 | 12 | 3.29 |
| J2624SW | 1-1/2 | 38 | 2-3/16 | 1 | 1-1/2 | 12 | 3.35 |
| J2625SW | 1-9/16 | | 2-21/32 | 1-1/8 | 1-7/16 | 12-1/4 | 3.89 |
| J2626SW | 1-5/8 | | 2-13/32 | 1-1/8 | 1-1/2 | 12-1/4 | 4.00 |
| J2627SW | 1-11/16 | 43 | 2-13/32 | 1-1/8 | 1-1/2 | 13-7/16 | 3.88 |
| J2628SW | 1-3/4 | | 2-19/32 | 1-3/16 | 1-9/16 | 13-7/16 | 3.90 |
| J2629SW | 1-13/16 | | 2-21/32 | 1-3/16 | 1-9/16 | 13-7/16 | 5.30 |
| J2630SW | 1-7/8 | | 2-27/32 | 1-1/4 | 1-21/32 | 13-7/16 | 5.24 |
| J2631SW | 1-15/16 | | 2-27/32 | 1-1/4 | 1-7/8 | 13-7/16 | 5.20 |
| J2632SW | 2 | 51 | 2-27/32 | 1-1/4 | 1-21/32 | 13-7/16 | 5.16 |
| J2633SW | 2-1/16 | | 3-1/8 | 1-1/4 | 2 | 13-1/2 | 6.82 |
| J2634SW | 2-1/8 | 54 | 3-1/8 | 1-1/2 | 2 | 13-7/8 | 6.71 |
| J2635SW | 2-3/16 | | 3-3/8 | 1-1/2 | 2 | 13-1/2 | 6.78 |
| J2636SW | 2-1/4 | 57 | 3-3/8 | 1-1/2 | 2 | 13-1/2 | 6.30 |
| J2637SW | 2-5/16 | | 3-3/8 | 1-1/2 | 2 | 13-1/2 | 7.94 |
| J2638SW | 2-3/8 | | 3-3/8 | 1-1/2 | 2 | 13-1/2 | 7.86 |
| J2639SW | 2-7/16 | | 3-13/16 | 1-1/2 | 2-1/4 | 13-1/2 | 7.67 |
| J2640SW | 2-1/2 | 64 | 4 | 1-1/2 | 2-1/4 | 13-1/2 | 7.62 |
| J2641SW | 2-9/16 | | 4 | 1-1/2 | 2-1/4 | 13-1/2 | 13.43 |
| J2642SW | 2-5/8 | | 4 | 1-1/2 | 2-1/4 | 13-1/2 | 10.42 |
| J2643SW | 2-11/16 | | 4-7/32 | 1-1/2 | 2-1/4 | 13-1/2 | 10.25 |
| J2644SW | 2-3/4 | | 4-7/32 | 1-1/2 | 2-1/4 | 13-1/2 | 10.18 |
| J2646SW | 2-7/8 | 73 | 4-25/32 | 1-7/8 | 2-5/8 | 16 | 13.84 |
| J2647SW | 2-15/16 | | 4-7/16 | 1-7/8 | 2-5/8 | 16 | 13.60 |
| J2648SW | 3 | | 4-7/16 | 1-7/8 | 2-5/8 | 16 | 13.44 |
| J2649SW | 3-1/16 | | 4-25/32 | 1-7/8 | 2-5/8 | 16 | 13.37 |
| J2650SW | 3-1/8 | | 4-7/16 | 1-7/8 | 2-5/8 | 16 | 13.18 |
| J2654SW | 3-3/8 | | 6-1/4 | 2-3/8 | 3-5/8 | 18 | 26.88 |
| J2656SW | 3-1/2 | | 6-1/4 | 2-3/8 | 3-5/8 | 18 | 26.37 |
| J2660SW | 3-3/4 | | 6-1/4 | 2-3/8 | 3-5/8 | 18 | 25.03 |
| J2662SW | 3-7/8 | | 6-1/4 | 2-3/8 | 3-5/8 | 18 | 24.58 |
| J2666SW | 4-1/8 | | 6-1/4 | 2-3/8 | 3-5/8 | 18 | 23.47 |
| J2668SW | 4-1/4 | | 6-1/4 | 2-3/8 | 3-5/8 | 18 | 22.75 |



BLACK OXIDE HEAVY-DUTY METRIC OFFSET STRIKING WRENCHES - 12 POINT

METRIC

- › Non-reflective black oxide finish for use where non-plated products are required.
- › 12 point box end allows for fine indexing, helping improve speed and access.
- › Fits most 4, 6 and 12 point fasteners.
- › Large striking surface for surer blow contact and more efficient transmittal of force to fastener.
- › Short handle permits use in close quarters.
- › Box opening designed to remain on fastener when wrench is struck.
- › For use where extreme force is necessary to loosen or set large fasteners.
- › Heavy box walls provide greater torque transmission.
- › Offset handle clears obstructions.



| Product # | Size (mm) | Outside Head Width (in) (C) | Head Thickness (in) (D) | Offset Height (in) (E) | Overall Length (in) | Weight (lbs) |
|-----------|-----------|-----------------------------|-------------------------|------------------------|---------------------|--------------|
| J2632SWM | 32 | 1-57/64 | 53/64 | 1-3/16 | 10-3/4 | 0.88 |
| J2636SWM | 36 | 2-13/64 | 63/64 | 1-1/2 | 12-1/64 | 2.13 |
| J2641SWM | 41 | 2-13/32 | 1-7/64 | 1-1/2 | 12-1/4 | 2.37 |
| J2646SWM | 46 | 2-43/64 | 1-3/16 | 1-37/64 | 13-27/64 | 2.81 |
| J2650SWM | 50 | 2-53/64 | 1-17/64 | 1-21/32 | 13-27/64 | 6.36 |
| J2655SWM | 55 | 3-25/64 | 1-1/2 | 2-1/64 | 13-1/2 | 6.58 |
| J2660SWM | 60 | 3-25/64 | 1-1/2 | 2-1/64 | 13-1/2 | 9.19 |
| J2665SWM | 65 | 4-1/64 | 1-1/2 | 2-1/4 | 13-1/2 | 12.61 |
| J2670SWM | 70 | 4-1/64 | 1-1/2 | 2-1/4 | 13-1/2 | 12.11 |
| J2675SWM | 75 | 4-29/64 | 1-57/64 | 2-41/64 | 15-63/64 | 13.53 |
| J2680SWM | 80 | 4-29/64 | 1-57/64 | 2-41/64 | 15-63/64 | 13.16 |



BLACK OXIDE OFFSET STRIKING DUAL DIMENSION WRENCHES - 12 POINT

METRIC

- › Black oxide finish.
- › Large striking surface for surer blow contact and more efficient transmittal of force to fastener.
- › Short handle permits use in close quarters.
- › Box opening designed to remain on fastener when wrench is struck.
- › For use where extreme force is necessary to loosen or set large fasteners.
- › Heavy box walls provide greater torque transmission.
- › Offset handle clears obstructions.



| Product # | Size (in) | Size (mm) | Outside Head Width (in) (C) | Head Thickness (in) (D) | Offset Height (in) (E) | Overall Length (in) | Weight (lbs) |
|-----------|-----------|-----------|-----------------------------|-------------------------|------------------------|---------------------|--------------|
| J2617SW | 1-1/16 | 27 | 1-11/16 | 5/8 | 15/16 | 8-1/2 | 1.84 |
| J2619SW | 1-3/16 | 30 | 2-1/16 | 13/16 | 13/16 | 10-3/4 | 2.55 |
| J2622SW | 1-3/8 | 35 | 2-25/64 | 1 | 1-1/2 | 12 | 3.40 |
| J2624SW | 1-1/2 | 38 | 2-3/16 | 1 | 1-1/2 | 12 | 3.35 |
| J2627SW | 1-11/16 | 43 | 2-13/32 | 1-1/8 | 1-1/2 | 13-7/16 | 3.88 |
| J2632SW | 2 | 51 | 2-27/32 | 1-1/4 | 1-21/32 | 13-7/16 | 5.16 |
| J2634SW | 2-1/8 | 54 | 3-1/8 | 1-1/2 | 2 | 13-7/8 | 6.71 |
| J2636SW | 2-1/4 | 57 | 3-3/8 | 1-1/2 | 2 | 13-1/2 | 6.30 |
| J2640SW | 2-1/2 | 64 | 4 | 1-1/2 | 2-1/4 | 13-1/2 | 7.62 |
| J2646SW | 2-7/8 | 73 | 4-25/32 | 1-7/8 | 2-5/8 | 16 | 13.84 |



BLACK OXIDE OFFSET SLUGGING WRENCHES SUPER HEAVY-DUTY - 12 POINT

- ▶ Non-reflective black oxide finish for use where non-plated products are required.
- ▶ 12 point box end allows for fine indexing, helping improve speed and access.
- ▶ Designed for heavy use in close quarters where hammer or sledge is required to loosen frozen nuts or set large fasteners.
- ▶ High strength rectangular design withstands heavy sledging; transmits power more effectively to fastener.
- ▶ Box opening designed to remain in place on fastener when wrench is struck.
- ▶ Heavy box walls provide greater transmission of torque to fastener.
- ▶ Straighter handle design than striking wrenches resists springing, nut turns easier.



| Product # | Size (in) | Outside Head Width (in) (C) | Head Thickness (in) (D) | Offset Height (in) (E) | Overall Length (in) | Weight (lbs) |
|-----------|-----------|-----------------------------|-------------------------|------------------------|---------------------|--------------|
| JUSN321 | 1-5/16 | 2-3/8 | 7/8 | 11/16 | 8-3/8 | 2.03 |
| JUSN322 | 1-3/8 | 2-3/8 | 7/8 | 11/16 | 8-3/8 | 2.00 |
| JUSN323 | 1-7/16 | 2-3/8 | 7/8 | 11/16 | 8-3/8 | 1.95 |
| JUSN324 | 1-1/2 | 2-3/4 | 1-1/8 | 1 | 10 | 3.54 |
| JUSN326 | 1-5/8 | 2-3/4 | 1-1/8 | 1 | 10-1/8 | 3.41 |
| JUSN327 | 1-11/16 | 2-3/4 | 1-1/8 | 1 | 10-1/8 | 3.31 |
| JUSN328 | 1-3/4 | 2-3/4 | 1-1/8 | 1 | 10-1/8 | 3.36 |
| JUSN329 | 1-13/16 | 2-3/4 | 1-1/8 | 1 | 10-1/8 | 3.20 |
| JUSN330 | 1-7/8 | 3 | 1-1/4 | 1-1/8 | 10-3/4 | 3.92 |
| JUSN332 | 2 | 3 | 1-5/16 | 1-1/8 | 10-13/16 | 3.71 |
| JUSN333 | 2-1/16 | 3 | 1-5/16 | 1-1/8 | 11 | 4.21 |
| JUSN334 | 2-1/8 | 3 | 1-5/16 | 1-1/8 | 11 | 4.74 |
| JUSN335 | 2-3/16 | 3-9/16 | 1-3/8 | 1-1/4 | 11 | 5.11 |
| JUSN336 | 2-1/4 | 3-9/16 | 1-3/8 | 1-1/4 | 11 | 4.86 |
| JUSN338 | 2-3/8 | 4-1/8 | 1-5/8 | 1-1/2 | 14-1/2 | 8.75 |
| JUSN339 | 2-7/16 | 4-1/8 | 1-5/8 | 1-1/2 | 14-1/2 | 8.86 |
| JUSN340 | 2-1/2 | 4-1/8 | 1-5/8 | 1-1/2 | 14-13/32 | 8.46 |
| JUSN341 | 2-9/16 | 4-1/8 | 1-5/8 | 1-1/2 | 14-1/2 | 8.37 |
| JUSN342 | 2-5/8 | 4-1/8 | 1-5/8 | 1-1/2 | 14-13/32 | 8.35 |
| JUSN344 | 2-3/4 | 4-1/8 | 1-5/8 | 1-1/2 | 14-1/2 | 7.80 |
| JUSN345 | 2-13/16 | 4-5/8 | 1-7/8 | 1-3/4 | 15-13/16 | 9.06 |
| JUSN347 | 2-15/16 | 4-5/8 | 1-7/8 | 1-3/4 | 15-1/2 | 12.17 |
| JUSN348 | 3 | 4-5/8 | 1-7/8 | 1-3/4 | 15-1/2 | 12.14 |
| JUSN350 | 3-1/8 | 4-5/8 | 1-7/8 | 1-7/8 | 15-19/32 | 11.29 |
| JUSN354 | 3-3/8 | 5-1/4 | 2 | 1-7/8 | 17-1/2 | 15.41 |
| JUSN356 | 3-1/2 | 5-1/4 | 2 | 1-7/8 | 17-13/32 | 15.79 |
| JUSN360 | 3-3/4 | 5-1/2 | 2-1/2 | 1-7/8 | 18-3/16 | 22.74 |
| JUSN362 | 3-7/8 | 5-1/2 | 2-1/2 | 1-7/8 | 18 | 22.11 |
| JUSN366 | 4-1/8 | 6-1/8 | 2-7/8 | 1-7/8 | 18-3/16 | 27.92 |
| JUSN368 | 4-1/4 | 6-1/8 | 2-7/8 | 1-7/8 | 18-3/16 | 26.83 |
| JUSN372 | 4-1/2 | 6-5/8 | 3 | 1-7/8 | 20 | 32.06 |
| JUSN374 | 4-5/8 | 6-5/8 | 3 | 1-7/8 | 20-3/16 | 30.54 |

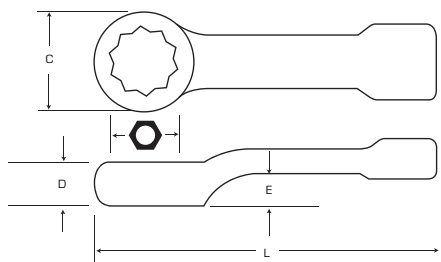

BLACK OXIDE METRIC OFFSET SLUGGING WRENCHES SUPER HEAVY-DUTY - 12 POINT



- › Non-reflective black oxide finish for use where non-plated products are required.
- › 12 point box end allows for fine indexing, helping improve speed and access.
- › Fits most 4, 6 and 12 point fasteners.
- › Designed for heavy use in close quarters where hammer or sledge is required to loosen frozen nuts or set large fasteners.
- › High strength rectangular design withstands heavy sledging.
- › Box opening designed to remain in place on fastener when wrench is struck.
- › Heavy box walls provide greater transmission of torque to fastener.
- › Straighter handle design than striking wrenches resists springing, nut turns easier.



| Product # | Size (mm) | Outside Head Width (in) (C) | Head Thickness (in) (D) | Offset Height (in) (E) | Overall Length (in) | Weight (lbs) |
|-----------|-----------|-----------------------------|-------------------------|------------------------|---------------------|--------------|
| JHD032M | 32 | 2-23/64 | 55/64 | 43/64 | 8-25/64 | 1.27 |
| JHD036M | 36 | 2-23/64 | 55/64 | 43/64 | 8-25/64 | 1.27 |
| JHD041M | 41 | 2-3/4 | 1-9/64 | 63/64 | 10-1/8 | 1.36 |
| JHD046M | 46 | 2-3/4 | 1-9/64 | 63/64 | 10-1/8 | 1.31 |
| JHD050M | 50 | 2-63/64 | 1-17/64 | 1-7/64 | 10-3/4 | 1.80 |
| JHD055M | 55 | 3-37/64 | 1-3/8 | 1-17/64 | 10-63/64 | 2.27 |
| JHD060M | 60 | 4-9/64 | 1-39/64 | 1-1/2 | 14-31/64 | 3.63 |
| JHD065M | 65 | 4-9/64 | 1-39/64 | 1-1/2 | 14-31/64 | 3.50 |
| JHD070M | 70 | 4-9/64 | 1-39/64 | 1-1/2 | 14-31/64 | 3.36 |
| JHD075M | 75 | 4-41/64 | 1-57/64 | 1-47/64 | 15-3/4 | 12.15 |
| JHD080M | 80 | 5-15/64 | 2-1/64 | 1-27/32 | 17-23/64 | 11.35 |
| JHD085M | 85 | 5-15/64 | 2-1/64 | 1-27/32 | 17-23/64 | 16.96 |
| JHD090M | 90 | 5-33/64 | 2-33/64 | 1-57/64 | 17-3/4 | 15.16 |
| JHD095M | 95 | 5-33/64 | 2-33/64 | 1-57/64 | 17-3/4 | 22.75 |
| JHD100M | 100 | 5-63/64 | 2-7/8 | 1-31/32 | 17-63/64 | 28.51 |
| JHD105M | 105 | 5-63/64 | 2-7/8 | 1-31/32 | 17-63/64 | 27.26 |
| JHD110M | 110 | 6-1/2 | 2-63/64 | 2-3/64 | 17-63/64 | 33.22 |
| JHD115M | 115 | 6-1/2 | 2-63/64 | 2-3/64 | 19-49/64 | 31.89 |

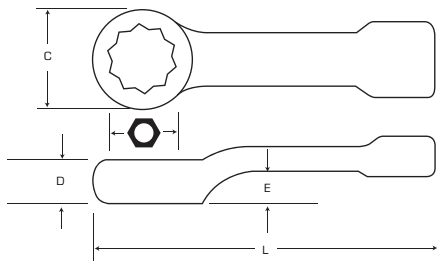

FACOM® BLACK OXIDE METRIC ENGINEER WRENCHES



- › Forged in carbon steel and hardened to high torque applications.
- › Hook eye.
- › Black oxide finish.
- › Long handle for extra leverage



| Product # | Size (mm) | Outside Head Width (in) (C) | Head Thickness (in) (D) | Overall Length (in) | Weight (lbs) |
|-----------------|-----------|-----------------------------|-------------------------|---------------------|--------------|
| FM-45.30 | 30 | 2-7/16 | 7/16 | 10-1/4 | 0.75 |
| FM-45.32 | 32 | 2-19/32 | 15/32 | 11-7/32 | 0.92 |
| FM-45.34 | 34 | 2-19/32 | 15/32 | 12-5/32 | 1.29 |
| FM-45.36 | 36 | 2-29/32 | 1/2 | 12-13/32 | 1.28 |
| FM-45.38 | 38 | 2-29/32 | 1/2 | 12-19/32 | 1.63 |
| FM-45.41 | 41 | 3-23/64 | 17/32 | 13-3/8 | 1.93 |
| FM-45.46 | 46 | 3-49/64 | 5/8 | 15-9/16 | 2.39 |
| FM-45.50 | 50 | 4-1/64 | 5/8 | 16-23/32 | 3.05 |
| FM-45.55 | 55 | 4-27/64 | 5/8 | 16-23/32 | 3.04 |
| FM-45.60 | 60 | 4-53/64 | 23/32 | 18-1/2 | 5.45 |
| FM-45.65 | 65 | 5-9/64 | 23/32 | 18-1/2 | 5.43 |
| FM-45.70 | 70 | 5-5/8 | 25/32 | 19-11/16 | 7.51 |
| FM-45.75 | 75 | 5-15/16 | 13/16 | 19-11/16 | 7.47 |



11 PIECE FACOM® METRIC LEVERAGE WRENCHES AND HANDLES



Product #: **FM-54.P9M**

- › Weight (lbs): 29.76

| Contents | Size (mm) | Point Count | Overall Length (in) |
|-----------|-----------|-------------|---------------------|
| FM-54A.24 | 24 | 12 | 7-3/32 |
| FM-54A.30 | 30 | 12 | 8-9/32 |
| FM-54A.32 | 32 | 12 | 9-7/16 |
| FM-54A.36 | 36 | 12 | 9-27/32 |
| FM-54A.41 | 41 | 12 | 10-5/8 |
| FM-54A.46 | 46 | 12 | 11-1/32 |
| FM-54A.50 | 50 | 12 | 11-5/8 |
| FM-54A.55 | 55 | 12 | 11-11/16 |
| FM-54.M1B | Handle | | 18 |
| FM-54.M2B | Handle | | 23-1/2 |
| FM-54.M3B | Handle | | 30 |

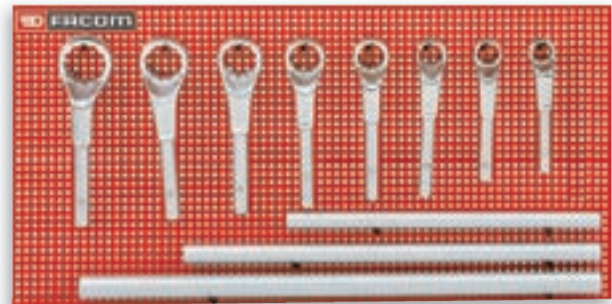

FACOM® SATIN METRIC LEVERAGE WRENCHES



- › Satin finish provides corrosion resistance and a slip-resistant grip.
- › Separate removable handle used when extra leverage is needed.
- › 12 point, box end allows for fine indexing, helping to improve speed and access.
- › 30° offset handle helps clear obstructions.



| Product # | Size (mm) | Outside Head Width (in) (C) | Head Thickness (in) (D) | Overall Length (in) | Use Handle | Weight (lbs) |
|-----------|-----------|-----------------------------|-------------------------|---------------------|------------|--------------|
| FM-54A.24 | 24 | 1-1/2 | 21/32 | 7-3/32 | FM-54.M1B | 0.89 |
| FM-54A.30 | 30 | 1-57/64 | 23/32 | 8-9/32 | FM-54.M1B | 1.09 |
| FM-54A.32 | 32 | 1-59/64 | 23/32 | 9-7/16 | FM-54.M2B | 1.60 |
| FM-54A.36 | 36 | 2-1/8 | 25/32 | 9-27/32 | FM-54.M2B | 1.71 |
| FM-54A.41 | 41 | 2-7/16 | 7/8 | 10-5/8 | FM-54.M2B | 2.05 |
| FM-54A.46 | 46 | 2-23/32 | 29/32 | 11-1/32 | FM-54.M3B | 2.61 |
| FM-54A.50 | 50 | 2-63/64 | 1 | 11-5/8 | FM-54.M3B | 3.11 |
| FM-54A.55 | 55 | 3-3/16 | 1-1/8 | 11-11/16 | FM-54.M3B | 3.27 |
| FM-54A.60 | 60 | 3-35/64 | 1-3/16 | 13-25/32 | FM-54.M4B | 4.95 |
| FM-54A.65 | 65 | 3-55/64 | 1-5/16 | 14-3/8 | FM-54.M4B | 5.39 |
| FM-54A.70 | 70 | 4-9/64 | 1-13/32 | 14-3/8 | FM-54.M4B | 6.05 |

FACOM® SATIN LEVERAGE WRENCH HANDLES



- › Removable handle
- › Satin finish provides corrosion resistance and a slip-resistant grip.

| Product # | Overall Length (in) | Weight (lbs) |
|-----------|---------------------|--------------|
| FM-54.M1B | 18 | 1.35 |
| FM-54.M2B | 23-1/2 | 2.44 |
| FM-54.M3B | 30 | 4.73 |
| FM-54.M4B | 33-9/32 | 6.31 |



3 PIECE ADJUSTABLE WRENCH SET

Product #: J795

- › Satin finish provides corrosion resistance and a slip-resistant grip.
- › Extra wide jaw capacity.
- › Square jaw opening provides strength and tight fit.
- › Rugged I-beam style handle and reinforced stress areas; radius corner design.
- › Weight (lbs): 2.6

| Contents | Max. Opening (in) | Overall Length (in) |
|----------|-------------------|---------------------|
| J708 | 1-1/8 | 8 |
| J710 | 1-5/16 | 10 |
| J712 | 1-1/2 | 12 |
| J25TR22C | Tool Roll | |

ASME B107.100



3 PIECE CLIK-STOP® ADJUSTABLE WRENCH SET

Product #: J790

- › Clik-Stop® locking design holds the moving jaw of an adjustable wrench in place when the wrench is in use.
- › Satin finish provides corrosion resistance and a slip-resistant grip.
- › Extra wide jaw capacity.
- › Square jaw opening provides strength and tight fit.
- › Weight (lbs): 3.08

| Contents | Max. Opening (in) | Overall Length (in) |
|----------|-------------------|---------------------|
| J708L | 1-1/8 | 8 |
| J710L | 1-5/16 | 10 |
| J712L | 1-1/2 | 12 |
| J25TR22C | Tool Roll | |

 ASME B107.100



SATIN CLIK-STOP® ADJUSTABLE WRENCHES

- › Satin finish provides corrosion resistance and a slip-resistant grip.
- › Extra wide jaw capacity.
- › Square jaw opening provides strength and tight fit.
- › Clik-Stop® locking design holds the moving jaw of an adjustable wrench in place when the wrench is in use.

| Product # | Max Opening (in) | Overall Length (in) | Weight (lbs) |
|-----------|------------------|---------------------|--------------|
| J704L | 1/2 | 4 | 0.13 |
| J706L | 5/16 | 6 | 0.34 |
| J708L | 1-1/8 | 8 | 0.57 |
| J710L | 1-5/16 | 10 | 0.95 |
| J712L | 1-1/2 | 12 | 1.54 |
| J715L | 1-11/16 | 15 | 3.13 |
| J718L | 2-1/16 | 18 | 5.73 |
| J724L | 2-7/16 | 24 | 8.84 |

 ASME B107.100



BLACK OXIDE CLIK-STOP® ADJUSTABLE WRENCHES

- › Non-reflective black oxide finish for use where non-plated products are required.
- › Extra wide jaw capacity.
- › Square jaw opening provides strength and tight fit.
- › Clik-Stop® locking design holds the moving jaw of an adjustable wrench in place when the wrench is in use.

| Product # | Max Opening (in) | Overall Length (in) | Weight (lbs) |
|-----------|------------------|---------------------|--------------|
| J704SL | 1/2 | 4 | 0.14 |
| J706SL | 5/16 | 6 | 0.28 |
| J708SL | 1-1/8 | 8 | 0.57 |
| J710SL | 1-15/16 | 10 | 1.06 |
| J712SL | 1-1/2 | 12 | 1.50 |
| J715SL | 1-11/16 | 15 | 3.07 |
| J718SL | 2-1/16 | 18 | 5.60 |

 ASME B107.100



CUSHION GRIP ADJUSTABLE WRENCHES

- › Soft cushion grip for additional comfort.
- › Extra wide jaw capacity.
- › Square jaw opening provides strength and tight fit.

| Product # | Max Opening (in) | Overall Length (in) | Weight (lbs) |
|--------------|------------------|---------------------|--------------|
| J704G | 1/2 | 4 | 0.13 |
| J706G | 15/16 | 6 | 0.25 |
| J708G | 1-1/8 | 8 | 0.59 |
| J710G | 1-5/16 | 10 | 0.80 |
| J712G | 1-1/2 | 12 | 1.61 |

 ASME B107.100



SATIN ADJUSTABLE WRENCHES

- › Satin finish provides corrosion resistance and a slip-resistant grip.
- › Extra wide jaw capacity.
- › Square jaw opening provides strength and tight fit.
- › Rugged I-beam style handle and reinforced stress areas; radius corner design.

| Product # | Max Opening (in) | Overall Length (in) | Weight (lbs) |
|-------------|------------------|---------------------|--------------|
| J704 | 1/2 | 4 | 0.17 |
| J706 | 15/16 | 6 | 0.28 |
| J708 | 1-1/8 | 8 | 0.58 |
| J710 | 1-5/16 | 10 | 0.90 |
| J712 | 1-1/2 | 12 | 1.58 |
| J715 | 1-11/16 | 15 | 3.00 |
| J718 | 2-1/16 | 18 | 4.26 |
| J724 | 2-7/16 | 24 | 6.41 |

 AS4984 ASME B107.100

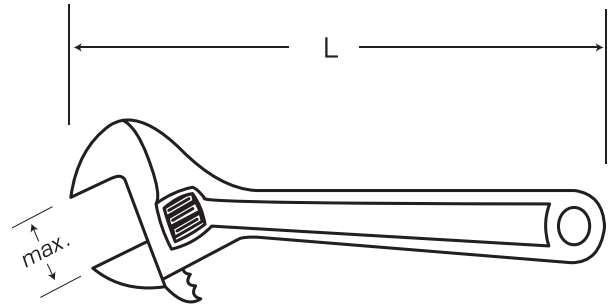

BLACK OXIDE ADJUSTABLE WRENCHES

- › Non-reflective black oxide finish for use where non-plated products are required.
- › Extra wide jaw capacity.
- › Square jaw opening provides strength and tight fit.

| Product # | Max Opening (in) | Overall Length (in) | Weight (lbs) |
|--------------|------------------|---------------------|--------------|
| J704S | 1/2 | 4 | 0.17 |
| J706S | 15/16 | 6 | 0.28 |
| J708S | 1-1/8 | 8 | 0.58 |
| J710S | 1-5/16 | 10 | 0.90 |
| J712S | 1-1/2 | 12 | 1.58 |
| J715S | 1-11/16 | 15 | 3.00 |
| J718S | 2-1/16 | 18 | 4.26 |
| J724S | 2-7/16 | 24 | 6.41 |

 ASME B107.100



FACOM® INSULATED ADJUSTABLE WRENCHES



- › Finger stops help keep hands safe.
- › 2 color warning handle insulation - color changes from orange to yellow if insulation integrity is compromised.
- › Graduated head, 15° angle.
- › Burnished finish.
- › Thumbwheel rotates counterclockwise.

| Product # | Max Opening (in) | Overall Length (in) | Weight (lbs) |
|-----------------------|------------------|---------------------|--------------|
| FA-113.8TAVSE | 1-1/16 | 8-15/32 | 0.83 |
| FA-113.10TAVSE | 1-3/16 | 10-7/16 | 1.37 |
| FA-113.12TAVSE | 1-11/32 | 12-19/32 | 1.93 |
| FA-113.15TAVSE | 1-47/64 | 15-9/16 | 3.12 |



BLACK OXIDE SPUD HANDLE ADJUSTABLE WRENCH

- › Non-Reflective black oxide finish for use where none plated products are required.
- › Large jaw opening fits all nuts and bolts up to 1-1/2 inches.
- › Square jaw opening provides strength and tight fit.
- › Eliminates the need for carrying several fixed size wrenches.
- › Hardened taper handle aligns bolt and rivet holes.

| Product # | Max Opening (in) | Overall Length (in) | Weight (lbs) |
|---------------|------------------|---------------------|--------------|
| J712SC | 1-1/2 | 16-3/32 | 2.45 |



FACOM® SATIN MONKEY WRENCHES



- › Satin finish provides corrosion resistance and a slip-resistant grip.
- › Sturdy, wide-opening tools for heavy-duty work on farms and building sites.
- › Fixed jaw/handle and worm gear made from hardened steel.
- › Smooth jaw faces help prevent marring of fastener surfaces.

| Product # | Max Opening (in) | Jaw Depth (in) | Jaw Thickness (in) | Height (in) | Overall Length (in) | Weight (lbs) |
|-------------------|------------------|----------------|--------------------|-------------|---------------------|--------------|
| FA-105.230 | 2-3/8 | 1-25/32 | 25/32 | 19/32 | 9-1/16 | 1.15 |
| FA-105.280 | 2-3/4 | 1-11/32 | 21/32 | 25/32 | 11-1/32 | 1.79 |
| FA-105.375 | 3-1/8 | 1-25/32 | 7/8 | 7/8 | 14-23/32 | 3.36 |

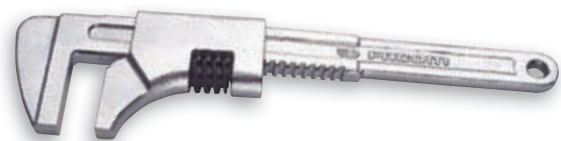

PROTO-GRIP™ CAST IRON PIPE WRENCHES

- › Gripping jaw teeth and spring-loaded hook jaw; allow one-hand operation or hands free option along with a ratcheting action for job speed.
- › Standard handle lengths with wide gripping surface for increased comfort on all jobs.
- › Forged steel jaw provides outstanding strength.
- › Heel Jaw designed to work in both directions.
- › Spring hook jaw provides a ratcheting function making threaded pipe fitting efficient.
- › Hanging hole for storage.
- › Field repairable by removing the rivet pin located on the bottom side of the jaw.
- › Replacement parts available.



| Product # | Max Opening (in) | Overall Length (in) | Weight (lbs) |
|---------------|------------------|---------------------|--------------|
| J810PG | 1-1/2 | 10 | 1.98 |
| J814PG | 2 | 14 | 3.64 |

ALUMINUM PIPE WRENCHES

- › Light weight aluminum for less job fatigue.
- › Standard handle lengths with wide gripping surface for increased comfort and one-hand operation.
- › Forged steel jaw provides outstanding strength.
- › Large knurl and power threads provide fast, positive jaw adjustment.
- › Graduation markings on hook jaw show approximate opening for pipe sizes.
- › Riveted jaw pin for safety.
- › Hanging hole for storage.
- › Field repairable by removing the rivet pin located on the bottom side of the jaw.
- › Replacement parts available.

| Product # | Max Opening (in) | Overall Length (in) | Weight (lbs) |
|--------------|------------------|---------------------|--------------|
| J810A | 1-1/2 | 10 | 1.10 |
| J812A | 2 | 12 | 1.72 |
| J814A | 2 | 14 | 2.15 |
| J818A | 3-1/2 | 18 | 3.60 |
| J824A | 4 | 24 | 5.65 |
| J836A | 5 | 36 | 10.60 |
| J848A | 6 | 48 | 17.00 |



HEAVY-DUTY CAST IRON PIPE WRENCHES

- › Forged steel jaw provides outstanding strength.
- › Full floating hook jaw, provides instant grip, easy release.
- › Large knurl and power threads provide fast, positive jaw adjustment.

| Product # | Max Opening (in) | Overall Length (in) | Weight (lbs) |
|-----------|------------------|---------------------|--------------|
| J806HD | 3/4 | 6 | 0.45 |
| J808HD | 1 | 8 | 0.80 |
| J810HD | 1-1/2 | 10 | 1.76 |
| J812HD | 2 | 12 | 2.66 |
| J814HD | 2 | 14 | 3.76 |
| J818HD | 3-1/2 | 18 | 5.82 |
| J824HD | 4 | 24 | 9.58 |
| J836HD | 5 | 36 | 19.32 |
| J848HD | 6 | 48 | 35.36 |
| J860HD | 8 | 60 | 41.40 |

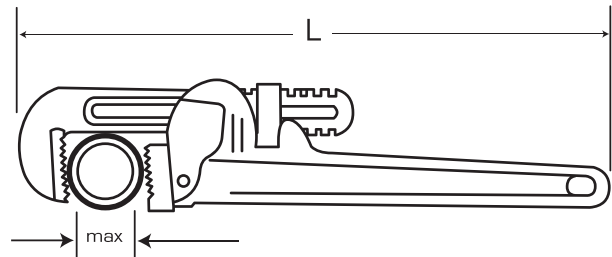

PIPE WRENCH REPLACEMENT PARTS

- › Replacement parts for heavy-duty pipe wrenches.

| Parts For | Handle, Heel Jaw, and Pin Assemble | Weight (lbs) | Hook Jaw | Weight (lbs) | Heel Jaw and Pin | Weight (lbs) | Knurl | Weight (lbs) | Coil and Flat Spring | Weight (lbs) |
|-----------|------------------------------------|--------------|----------|--------------|------------------|--------------|-------|--------------|----------------------|--------------|
| J806HD | J806H | 0.33 | J806B | 0.11 | J806C | 0.02 | J806D | 0.03 | J806E | 0.01 |
| J808HD | J808H | 0.61 | J808B | 0.23 | J808C | 0.04 | J808D | 0.03 | J808E | 0.01 |
| J810HD | J810H | 1.20 | J810B | 0.45 | J810C | 0.08 | J810D | 0.07 | J810E | 0.01 |
| J812HD | J812H | 1.97 | J812B | 0.68 | J812C | 0.15 | J812D | 0.09 | J812E | 0.02 |
| J814HD | J814H | 2.79 | J814B | 0.97 | J814C | 0.15 | J814D | 0.11 | J814E | 0.03 |
| J818HD | J818H | 4.09 | J818B | 1.57 | J818C | 0.23 | J818D | 0.18 | J818E | 0.04 |
| J824HD | J824H | 7.35 | J824B | 2.36 | J824C | 0.32 | J824D | 0.31 | J824E | 0.06 |
| J836HD | J836H | 14.40 | J836B | 4.37 | J836C | 0.58 | J836D | 0.47 | J836E | 0.07 |
| J848HD | - | - | J848B | 7.31 | J848C | 0.72 | J848D | 0.68 | J848E | 0.11 |
| J860HD | - | - | J860B | 12.50 | J860C | 1.50 | J860D | 0.85 | J860E | 0.08 |

| Parts For | Hook Jaw | Weight (lbs) | Heel Jaw | Weight (lbs) | Pin | Weight (lbs) | Spring | Weight (lbs) |
|-----------|----------|--------------|----------|--------------|---------|--------------|---------|--------------|
| J810PG | J810PGB | 0.60 | J810PGC | 0.31 | J810PGD | 0.04 | J810PGE | 0.01 |
| J814PG | J814PGB | 0.84 | J814PGC | 0.29 | J814PGD | 0.08 | J814PGE | 0.01 |

4 PIECE INTERNAL PIPE WRENCH SET

Product #: J140SET

- › Ideal for removing broken threaded pipe ends, plugs, and fittings.
- › Installation and removal without thread damage.
- › Eccentric cam action engages wrench against the walls of the pipe.
- › Hex body allows for use of adjustable wrench for added torque.
- › Made from hardened steel and plated to help prevent rust.
- › Weight (lbs): 1.95

| Contents | Size (in) | Overall Length (in) |
|----------|-----------|---------------------|
| J140-38 | 3/8 | 3 |
| J140-34 | 3/4 | 3 |
| J140-12 | 1/2 | 3 |
| J140-1 | 1 | 3 |



INTERNAL PIPE WRENCHES

- › Ideal for removing broken threaded pipe ends pipe plugs and fittings.
- › Installation and removal without thread damage.
- › Eccentric cam action engages wrench against the walls of the pipe.
- › Hex body allows for use of adjustable wrench for added torque.
- › Made from hardened steel and plated to help prevent rust.

| Product # | Size (in) | Overall Length | |
|----------------|-----------|----------------|--------------|
| | | (in) | Weight (lbs) |
| J140-38 | 3/8 | 3 | 0.21 |
| J140-34 | 3/4 | 3 | 0.49 |
| J140-12 | 1/2 | 3 | 0.32 |
| J140-1 | 1 | 3 | 0.85 |



UNIVERSAL CHAIN WRENCH

- › Fits any shape pipe.
- › Forged steel handle has deep milled teeth.
- › Chain capacity rating: 6,200 lbs.

| Product # | Capacity Range (in) | Overall Length (in) | Weight (lbs) |
|-------------|---------------------|---------------------|--------------|
| J801 | 7/8 to 4 | 16-1/2 | 2.33 |



UNIVERSAL CHAIN WRENCH REPAIR KIT

- › Fits any shape pipe.
- › Chain capacity rating: 6,200 lbs.



| Product # | Overall Length (in) | Weight (lbs) |
|---------------|---------------------|--------------|
| J801RK | 6-1/5 | 0.73 |

BLACK OXIDE ADJUSTABLE FACE SPANNER WRENCHES

- › Non-reflective black oxide finish for use where non-plated products are required.
- › Precision machined pins provide engagement with holes or slots on the face of a bearing or nut.
- › Used to tighten collars, lock nut rings and seal/packing nuts on hydraulic cylinders.



| Product # | Max Opening (in) | Pin Diameter (in) | Pin Length (in) | Overall Length (in) | Weight (lbs) |
|--------------|------------------|-------------------|-----------------|---------------------|--------------|
| JC482 | 2 | 3/16 | 1/4 | 6-3/8 | 0.31 |
| JC483 | 3 | 1/4 | 1/4 | 8-1/4 | 0.52 |
| JC484 | 4 | 5/16 | 1/2 | 10-3/8 | 1.02 |



FACOM® SATIN FACE SPANNER - ROUND PIN



- › Satin finish provides corrosion resistance and a slip-resistant grip.
- › Precision machined pins provide engagement with round holes on the face of the nut.
- › Each double-ended, round interchangeable pin has two diameters for a variety of applications.



| Product # | Max Opening (in) | Height (in) | Overall Length (in) | Weight (lbs) |
|-----------------|------------------|-------------|---------------------|--------------|
| FA-117.B | 4 | 1-25/32 | 9-3/4 | 1.45 |

FACOM® SATIN METRIC PIN REPLACEMENTS - ROUND



| Product # | Size (mm) | Pin Diameter (in) | Height (in) | Weight (lbs) |
|-----------|-----------|-------------------|-------------|--------------|
| FA-117.E1 | 2.5 - 4 | 3/32 & 5/32 | 19/32 | 0.03 |
| FA-117.E2 | 6 - 8 | 1/4 & 5/16 | 19/32 | 0.05 |
| FA-117.E3 | 3 - 5 | 1/8 & 3/16 | 19/32 | 0.03 |
| FA-117.E4 | 7 - 9 | 9/32 & 11/32 | 19/32 | 0.06 |



FACOM® SATIN FACE SPANNER - SQUARE PIN



- › Satin finish provides corrosion resistance and a slip-resistant grip.
- › Precision machined square pins provide engagement with square holes or slots on the face of the nut.
- › Interchangeable pins are easy to swap out.

| Product # | Max Opening (in) | Height (in) | Overall Length (in) | Weight (lbs) |
|-----------|------------------|-------------|---------------------|--------------|
| FA-118A | 4 | 1-25/32 | 9-3/4 | 1.41 |



FACOM® SATIN METRIC PIN REPLACEMENTS - SQUARE



| Product # | Size (mm) | Pin Diameter (in) | Height (in) | Weight (lbs) |
|------------|-----------|-------------------|-------------|--------------|
| FA-118.EC4 | 4 | 5/32 | 19/32 | 0.02 |
| FA-118.EC5 | 5 | 6/32 | 3/8 | 0.02 |
| FA-118.EC8 | 8 | 10/32 | 3/8 | 0.03 |



FACOM® METRIC HINGED HOOK SPANNER WRENCHES



| Product # | Size (mm) | Max Opening (in) | Head Thickness (in) (D) | Hook Thickness (in) | Height (in) | Overall Length (in) | Weight (lbs) |
|-------------|-----------|------------------|-------------------------|---------------------|-------------|---------------------|--------------|
| FA-125A.35 | 15-35 | 1-1/2 | 13/64 | 1/8 | 5/16 | 6-39/64 | 0.17 |
| FA-125A.50 | 35-50 | 1-31/32 | 15/64 | 5/32 | 7/16 | 7-61/64 | 0.37 |
| FA-125A.80 | 50-80 | 3-5/32 | 5/16 | 13/64 | 7/16 | 11-1/32 | 0.83 |
| FA-125A.120 | 80-120 | 4-23/32 | 23/64 | 7/32 | 15/32 | 13-37/64 | 1.54 |
| FA-125A.180 | 120-180 | 7-3/32 | 7/16 | 19/64 | 15-15/16 | 19-3/8 | 3.26 |

WRENCHES



FACOM® HEAVY-DUTY METRIC HOOK SPANNER WRENCHES



| Product # | Size (mm) | Hook Thickness (in) | Overall Length (in) | Weight (lbs) |
|------------|-----------|---------------------|---------------------|--------------|
| FA-119.3/8 | 120-224 | 3/8 | 24 | 6.96 |
| FA-119.3/4 | 220-324 | 3/4 | 26 | 13.01 |

SPANNER

ADJUSTABLE HOOK SPANNER WRENCHES

- › Non-reflective black oxide finish for use where non-plated products are required.
- › Use to tighten side slot nuts on collars, lock nuts and bearings.



| Product # | Capacity Range | Hook Thickness (in) | Hook Depth (in) | Overall Length (in) | Weight (lbs) |
|-----------|----------------|---------------------|-----------------|---------------------|--------------|
| JC471 | 3/4 to 2 | 11/32 | 1/8 | 6-3/8 | 0.23 |
| JC472 | 1-1/4 to 3 | 13/32 | 5/32 | 8-1/8 | 0.43 |
| JC474 | 2 to 4-3/4 | 15/32 | 3/16 | 11-3/8 | 1.03 |
| JC474A | 4-1/2 to 6-1/4 | 15/32 | 1/4 | 12-1/8 | 1.07 |
| JC474B | 6-1/8 to 8-3/4 | 15/32 | 5/16 | 13-3/4 | 1.40 |

FACOM® ADJUSTABLE HEAVY-DUTY HOOK WRENCHES



- › Satin finish provides corrosion resistance and a slip-resistant grip.
- › Hook design is used to tighten side slots on collars, lock nuts and bearings.
- › Worm gear design allows for precision adjustments.



| Product # | Size (in) | Max Opening (in) | Height (in) | Overall Length (in) | Weight (lbs) |
|--------------------|-----------|------------------|-------------|---------------------|--------------|
| FA-115A.50 | 1 | 1-31/32 | 31/32 | 20-7/8 | 0.83 |
| FA-115A.100 | 3 | 3-15/16 | 25/32 | 8-15/32 | 1.96 |
| FA-115A.200 | 7 | 7-7/8 | 25/32 | 14-3/8 | 4.57 |

ADJUSTABLE PIN SPANNER WRENCHES

- › Non-reflective black oxide finish for use where non-plated products are required.
- › Precision machined pins provide engagement with side holes or slots.
- › Used to tighten side slot nuts on collars, lock nuts and bearings.



| Product # | Capacity Range | Pin Diameter (in) | Pin Length (in) | Hook Thickness (in) | Overall Length (in) | Weight (lbs) |
|--------------|----------------|-------------------|-----------------|---------------------|---------------------|--------------|
| JC491 | 3/4 to 2 | 1/8 | 1/8 | 11/32 | 6-3/8 | 0.23 |
| JC492 | 3/4 to 2 | 3/16 | 5/32 | 11/32 | 6-3/8 | 0.23 |
| JC494 | 1-1/4 to 3 | 3/16 | 3/16 | 13/32 | 8-1/8 | 0.42 |
| JC495 | 1-1/4 to 3 | 1/4 | 7/32 | 13/32 | 8-1/8 | 0.42 |
| JC497 | 2 to 4-3/4 | 1/4 | 1/4 | 15/32 | 11-3/8 | 0.99 |
| JC499 | 4-1/2 to 6-1/4 | 3/8 | 1/4 | 15/32 | 12-1/8 | 1.08 |



FACOM® PRECISION ADJUSTABLE PIN SPANNER WRENCHES



- › Satin finish provides corrosion resistance and a slip-resistant grip.
- › Sliding jaw moves easily along the shank and is designed to be self-locking on to the nut.
- › Precision machined pins provide engagement with holes on the sides of collars and nuts.
- › Interchangeable pins are easy to swap out.



| Product # | Size (in) | Max Opening (in) | Height (in) | Overall Length (in) | Weight (lbs) |
|-------------------|-----------|------------------|-------------|---------------------|--------------|
| FA-116.50 | 1 | 1-31/32 | 31/32 | 8-15/32 | 0.86 |
| FA-116.100 | 3 | 3-15/16 | 31/32 | 14-1/4 | 1.99 |
| FA-116.200 | 7 | 7-7/8 | 1-3/16 | 20-3/4 | 4.76 |



FACOM® PIN REPLACEMENTS FOR FA-116 SERIES



- › Replacement pins for Facom® FA-116.50, FA-116.100 and FA-116.200 Precision Adjustable Pin Spanner Wrenches.
- › Precision machined pins provide engagement with holes on the sides of collars and nuts.
- › Interchangeable pins are easy to swap out.

| Product # | Pin Diameter (in) | Pin Height (in) | Overall Length (in) | Weight (lbs) |
|--------------|-------------------|-----------------|---------------------|--------------|
| FA-116.50E1 | 3/32 | 3/8 | 25/32 | 0.01 |
| FA-116.50E2 | 5/32 | 3/8 | 25/32 | 0.01 |
| FA-116.100E1 | 5/32 | 19/32 | 31/32 | 0.03 |
| FA-116.100E2 | 1/4 | 19/32 | 31/32 | 0.03 |
| FA-116.200E1 | 1/4 | 19/32 | 1-3/16 | 0.08 |
| FA-116.200E2 | 5/16 | 19/32 | 1-3/16 | 0.08 |



FACOM® METRIC HINGED PIN SPANNER WRENCHES



| Product # | Size (mm) | Max Opening (in) | Pin Diameter (in) | Hook Thickness (in) | Height (in) | Overall Length (in) | Weight (lbs) |
|-------------|-----------|------------------|-------------------|---------------------|-------------|---------------------|--------------|
| FA-126A.35 | 15-35 | 1-2/4 | 1/8 | 25/64 | 19/32 | 6-39/64 | 0.17 |
| FA-126A.50 | 35-50 | 1-31/32 | 5/32 | 15/32 | 15/32 | 7-61/64 | 0.37 |
| FA-126A.80 | 50-80 | 3-5/32 | 13/64 | 35/64 | 15/32 | 11-1/32 | 0.79 |
| FA-126A.120 | 80-120 | 4-23/32 | 15/64 | 45/64 | 21/32 | 13-37/64 | 1.54 |
| FA-126A.180 | 120-180 | 7-3/32 | 5/16 | 25/32 | 23/32 | 19-3/8 | 3.17 |

FACOM® PIN REPLACEMENTS FOR FA-126A SERIES



- › Replacement pins for Facom® FA-126A.35, FA-126A.50, FA-126A.80, FA-126A.120 and FA-126A.180 Hinged Pin Spanner Wrenches.

| Product # | Pin Diameter (in) | Pin Height (in) | Weight (lbs) |
|-------------|-------------------|-----------------|--------------|
| FA-126.E35 | 4/32 | 3/8 | 0.01 |
| FA-126.E50 | 5/32 | 3/8 | 0.01 |
| FA-126.E80 | 6/32 | 3/8 | 0.01 |
| FA-126.E120 | 8/32 | 19/32 | 0.04 |
| FA-126.E180 | 10/32 | 25/32 | 0.07 |





PROTO

**A GOOD SCREWDRIVER IS A TOOL YOU CAN USE
ALL DAY AND NOT TIRE OF IT.**

It fits your hand. It has a certain heft. It's balanced. At Proto®, we craft professional grade screwdrivers and nut drivers with a full range of tip and drive variations. We make them with round and square steel alloy shanks, heat-treated along their entire length. We include features that enhance performance, for example, cross-ground slotted tips that don't climb out of screw slots. And we make specialty variations, like our fully insulated, 1,000 volt line which prevents hock and is tested by hand. Pick up a Proto® driver and you won't want to put it down.

SCREWDRIVERS, HEX KEYS, AND NUT DRIVERS

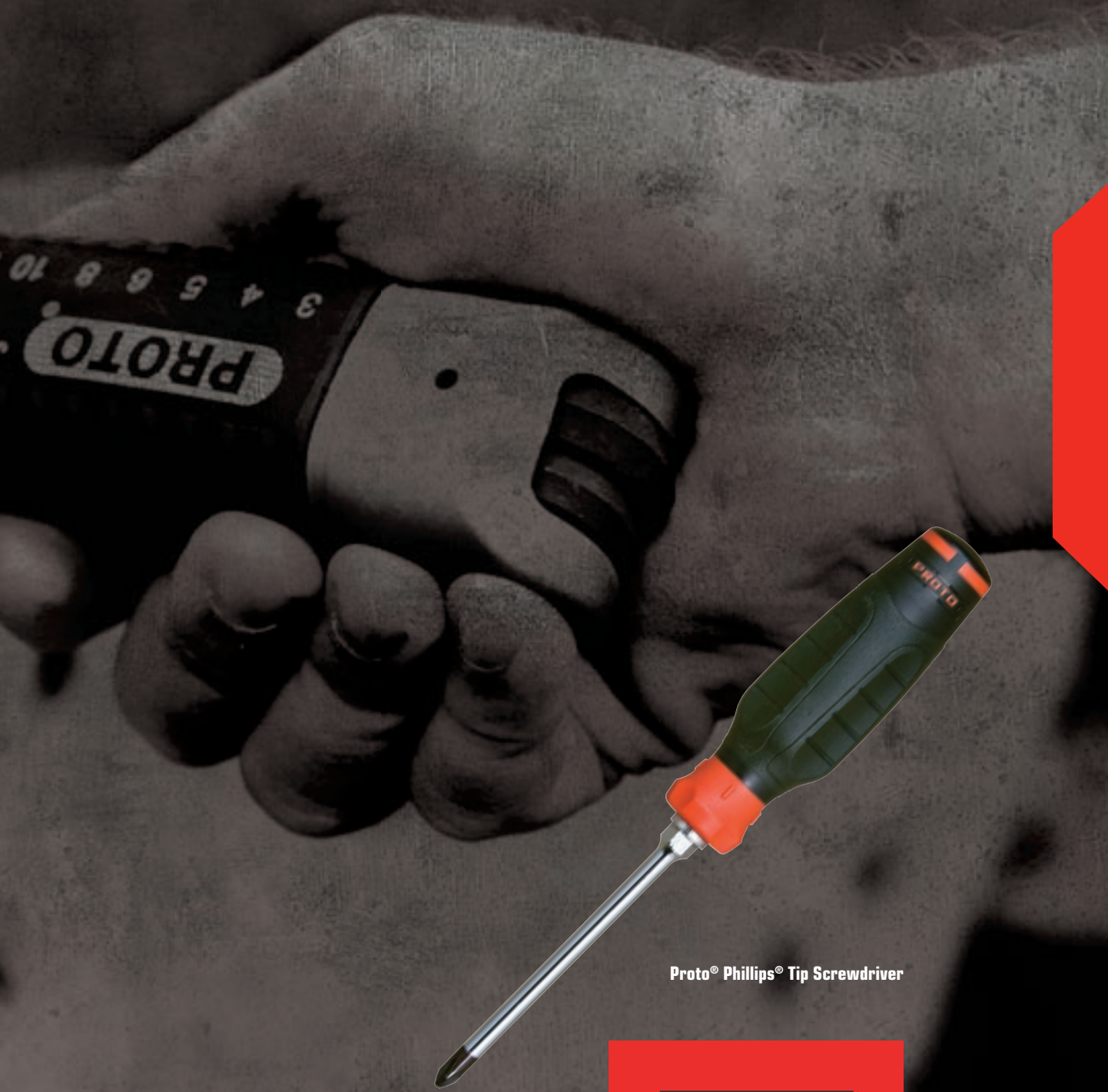

Proto® Phillips® Tip Screwdriver

PROTO



PROTO® SCREWDRIVERS

- › Ergonomically designed quad-lobe handle design with 360° texture for additional grip.
- › Designed to meet demanding heavy-duty needs of industrial maintenance and assembly applications.

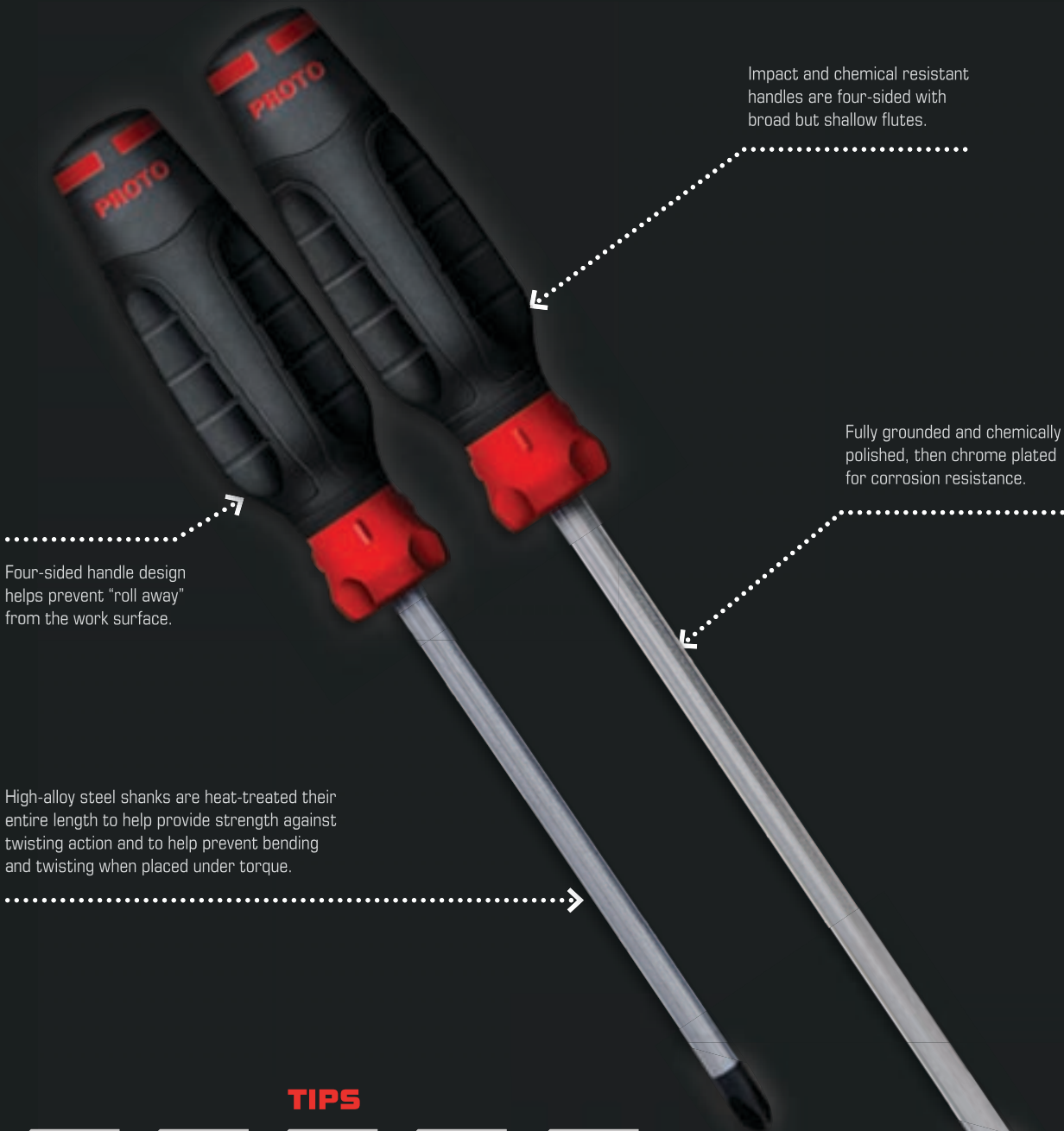

Impact and chemical resistant handles are four-sided with broad but shallow flutes.

Four-sided handle design helps prevent "roll away" from the work surface.

Fully grounded and chemically polished, then chrome plated for corrosion resistance.

High-alloy steel shanks are heat-treated their entire length to help provide strength against twisting action and to help prevent bending and twisting when placed under torque.

TIPS

Cabinet Keystone Phillips® Torx® Square

Finished in black oxide to help prevent cam out and slipping.

SCREWDRIVER GUIDE



PROTO®



INSERT BIT



SUPER PROTO®

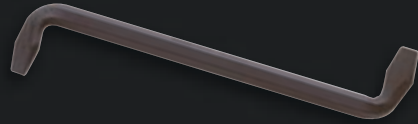

OFFSET



SOFT GRIP



NUT DRIVER



HEX



**INSULATED
NUT DRIVER**



INSULATED



INSULATED T-HANDLE

HEX KEY STYLE

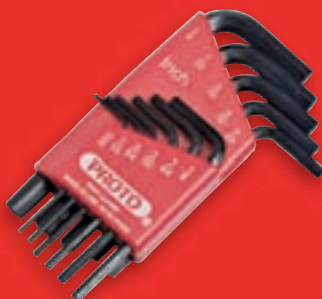

STANDARD



METRIC



T-HANDLE



FOLDING



FEATURES AND BENEFITS – QUAD-LOBE

- › Ergonomically designed quad-lobe handle design with 360° texture for additional grip.
- › Designed to meet demanding heavy-duty needs of industrial maintenance and assembly applications.

HANDLE

- › Impact and chemical resistant handles are four-sided with broad but shallow flutes.
- › Resistant to most harsh chemicals (including hydraulic fluids used in the aerospace industry).
- › Four-sided handle design helps prevent "roll away" from the work surface.

SHANK

- › High-alloy steel shanks are heat-treated their entire length to help provide strength against twisting action and to help prevent bending and twisting when placed under torque.
- › Fully grounded and chemically polished, then chrome plated for corrosion resistance.

TIP

- › Made of high-alloy steel (same as shank).
- › Precision machined for precise fastener fit.
- › Finished in black oxide to help prevent cam out and slipping.
- › Tips are un-plated with a black oxide finish to help prevent chrome peeling; an important Foreign Object Debris (FOD) concern.



› Ergonomically designed handle design for improved grip



› Black oxide tip prevents chrome peeling

SCREWDRIVER PRODUCT NUMBER IDENTIFICATION

Proto®'s item numbering system for screwdrivers is designed to make it easy for users to identify the tool that has the size and configuration that best meets their needs.

EXAMPLE: JPBO408RP

Part Number Key

| | | | |
|--|--|----------------|----------------|
| <p>■ Feature Code - Series (1st Position)</p> | P = Phillips® | C = Cabinet | K = Keystone |
| | S = Square | T = Torx® | N = Nut Driver |
| | H = Hex | Z = Pozi | |
| <p>■ Feature Code - Series (2nd Position)</p> | B = Bolster | P = Precision | |
| <p>■ Tip Size</p> | | | |
| <p>■ Bar Length</p> | | | |
| <p>■ Feature Code - Bar Style</p> | R = Round Bar | S = Square Bar | |
| | <p>■ Feature Code - Special Feature</p> | P = Polish | H = Hollow |



19 PIECE COMBINATION PROTO® SCREWDRIVER SET

Product #: J1219SC

► Quad-lobe features apply. (See pages 670 or 676)



Delayed Availability
Representative Image



| Contents | Description | Tip Size | Tips | Shank Length (in) (L1) | Shank Type | Overall Length (in) | ASME Spec. |
|----------|--|----------|-----------|------------------------|------------|---------------------|---------------|
| JCP1803R | Screwdriver, Slotted Cabinet, Round 1/8" x 3" | 1/8 | Cabinet | 3 | Round | 5 | ASME B107.600 |
| JCP1804R | Screwdriver, Slotted Cabinet, Round 1/8" x 4" | 1/8 | Cabinet | 4 | Round | 6 | ASME B107.600 |
| JCP1808R | Screwdriver, Slotted Cabinet, Round 1/8" x 8" | 1/8 | Cabinet | 8 | Round | 10 | ASME B107.600 |
| JC31604R | Screwdriver, Slotted Cabinet, Round 3/16" x 4" | 3/16 | Cabinet | 4 | Round | 7 | ASME B107.600 |
| JK31604S | Screwdriver, Slotted Keystone, Square 3/16" x 4" | 3/16 | Keystone | 4 | Square | 7 | ASME B107.600 |
| JC31608R | Screwdriver, Slotted Cabinet, Round 3/16" x 8" | 3/16 | Cabinet | 8 | Round | 11 | ASME B107.600 |
| JK14112R | Screwdriver, Slotted Keystone, Round, Stubby 1/4" x 1-1/2" | 1/4 | Keystone | 1-1/2 | Round | 3-1/2 | ASME B107.600 |
| JK1404S | Screwdriver, Slotted Keystone, Square 1/4" x 4" | 1/4 | Keystone | 4 | Square | 8 | ASME B107.600 |
| JK51606S | Screwdriver, Slotted Keystone, Square 5/16" x 6" | 5/16 | Keystone | 6 | Square | 10 | ASME B107.600 |
| JK3808S | Screwdriver, Slotted Keystone, Square 3/8" x 8" | 3/8 | Keystone | 8 | Square | 13 | ASME B107.600 |
| JK3812S | Screwdriver, Slotted Keystone, Square Bar 3/8" x 12" | 3/8 | Keystone | 12 | Square | 17 | ASME B107.600 |
| JPP0003R | Screwdriver, Phillips® Round #0 x 3" | 0 | Phillips® | 3 | Round | 5-3/4 | ASME B107.600 |
| JPD103R | Screwdriver, Phillips® Round #1 x 3" | 1 | Phillips® | 3 | Round | 6-3/4 | ASME B107.600 |
| JPD108R | Screwdriver, Phillips® Round #1 x 8" | 1 | Phillips® | 8 | Round | 11-3/4 | ASME B107.600 |
| JPD2112R | Screwdriver, Phillips® Round Stubby #2 x 1-1/2" | 2 | Phillips® | 1-1/2 | Round | 3-1/2 | ASME B107.600 |
| JPD204R | Screwdriver, Phillips® Round #2 x 4" | 2 | Phillips® | 4 | Round | 8 | ASME B107.600 |
| JPD208R | Screwdriver, Phillips® Round #2 x 8" | 2 | Phillips® | 8 | Round | 12 | ASME B107.600 |
| JPD306R | Screwdriver, Phillips® Round #3 x 6" | 3 | Phillips® | 6 | Round | 10-3/8 | ASME B107.600 |
| JPD408R | Screwdriver, Phillips® Round #4 x 8" | 4 | Phillips® | 8 | Round | 13 | ASME B107.600 |



8 PIECE COMBINATION PROTO® SCREWDRIVER SET**Product #: J1208SC**

- ▶ Quad-lobe features apply. (See pages 670 or 676)



Delayed Availability
Representative Image



| Contents | Description | Tip Size | Tips | Shank Length (in) (L1) | Shank Type | Overall Length (in) | ASME Spec. |
|----------|---|----------|-----------|------------------------|------------|---------------------|---------------|
| JC31603R | Screwdriver, Slotted Cabinet, Round 3/16" x 3" | 3/16 | Cabinet | 3 | Round | 6 | ASME B107.600 |
| JC31604R | Screwdriver, Slotted Cabinet, Round 3/16" x 4" | 3/16 | Cabinet | 4 | Round | 7 | ASME B107.600 |
| JC31605R | Screwdriver, Slotted Cabinet, Round 3/16" x 5" | 3/16 | Cabinet | 5 | Round | 8 | ASME B107.600 |
| JK1404R | Screwdriver, Slotted Keystone, Round 1/4" x 4" | 1/4 | Keystone | 4 | Round | 8 | ASME B107.600 |
| JK51606R | Screwdriver, Slotted Keystone, Round 5/16" x 6" | 5/16 | Keystone | 6 | Round | 10-3/8 | ASME B107.600 |
| JP0103R | Screwdriver, Phillips® Round #1 x 3" | 1 | Phillips® | 3 | Round | 6-3/4 | ASME B107.600 |
| JP0204R | Screwdriver, Phillips® Round #2 x 4" | 2 | Phillips® | 4 | Round | 8 | ASME B107.600 |
| JP0306R | Screwdriver, Phillips® Round #3 x 6" | 3 | Phillips® | 6 | Round | 10-3/8 | ASME B107.600 |

8 PIECE COMBINATION PROTO® SCREWDRIVER SET**Product #: J1208SCP**

- ▶ Quad-lobe features apply. (See pages 670 or 676)



Delayed Availability
Representative Image



| Contents | Description | Tip Size | Tips | Shank Length (in) (L1) | Shank Type | Bolster | Overall Length (in) | ASME Spec. |
|------------|---|----------|-----------|------------------------|------------|---------|---------------------|---------------|
| JK14112RP | Screwdriver, Slotted, Round 1/4" x 1-1/2" | 1/4 | Keystone | 1-1/2 | Round | — | 3-1/2 | ASME B107.600 |
| JKB31603RP | Screwdriver, Slotted Keystone, Round 3/16" x 3" | 3/16 | Keystone | 3 | Round | Yes | 6-3/4 | ASME B107.600 |
| JKB1404RP | Screwdriver, Slotted Keystone, Round 1/4" x 4" | 1/4 | Keystone | 4 | Round | Yes | 8 | ASME B107.600 |
| JKB51606RP | Screwdriver, Slotted Keystone, Round 5/16" x 6" | 5/16 | Keystone | 6 | Round | Yes | 10-3/8 | ASME B107.600 |
| JKB3808RP | Screwdriver, Slotted Keystone, Round 3/8" x 8" | 3/8 | Keystone | 8 | Round | Yes | 13 | ASME B107.600 |
| JP02112RP | Screwdriver, Phillips® Stubby #2 x 1-1/2" | 2 | Phillips® | 1-1/2 | Round | — | 3-1/2 | ASME B107.600 |
| JPB0103RP | Screwdriver, Phillips® Round #1 x 3" | 1 | Phillips® | 3 | Round | Yes | 6-3/4 | ASME B107.600 |
| JPB0204RP | Screwdriver, Phillips® Round #2 x 4" | 2 | Phillips® | 4 | Round | Yes | 8 | ASME B107.600 |



6 PIECE COMBINATION PROTO® SCREWDRIVER SET

Product #: **J1206SCP**

- ▶ Quad-lobe features apply. (See pages 670 or 676)



Delayed Availability
Representative Image

| Contents | Description | Tip Size | Tips | Shank Length (in) (L1) | Shank Type | Bolster | Overall Length (in) | ASME Spec. |
|------------|---|----------|-----------|------------------------|------------|---------|---------------------|---------------|
| JKB31603RP | Screwdriver, Slotted Keystone, Round 3/16" x 3" | 3/16 | Keystone | 3 | Round | Yes | 6-3/4 | ASME B107.600 |
| JKB1404RP | Screwdriver, Slotted Keystone, Round 1/4" x 4" | 1/4 | Keystone | 4 | Round | Yes | 8 | ASME B107.600 |
| JKB51606RP | Screwdriver, Slotted Keystone, Round 5/16" x 6" | 5/16 | Keystone | 6 | Round | Yes | 10-3/8 | ASME B107.600 |
| JPB0103RP | Screwdriver, Phillips® Round #1 x 3" | 1 | Phillips® | 3 | Round | Yes | 6-3/4 | ASME B107.600 |
| JPB0204RP | Screwdriver, Phillips® Round #2 x 4" | 2 | Phillips® | 4 | Round | Yes | 8 | ASME B107.600 |
| JPB0306RP | Screwdriver, Phillips® Round #3 x 6" | 3 | Phillips® | 6 | Round | Yes | 10-3/8 | ASME B107.600 |

8 PIECE LONG COMBINATION PROTO® SCREWDRIVER SET

Product #: **J1208SCL**

- ▶ Quad-lobe features apply. (See pages 670 or 676)

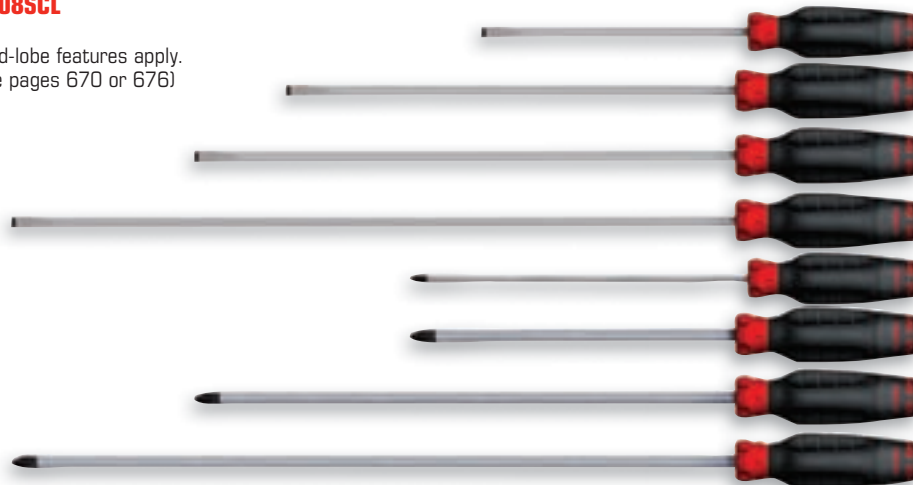

Delayed Availability
Representative Image

| Contents | Description | Tip Size | Tips | Shank Length (in) (L1) | Shank Type | Bolster | Overall Length (in) | ASME Spec. |
|----------|--|----------|-----------|------------------------|------------|---------|---------------------|---------------|
| JC31606R | Screwdriver, Slotted Cabinet, Round 3/16" x 6" | 3/16 | Cabinet | 6 | Round | - | 9 | ASME B107.600 |
| JC1410R | Screwdriver, Slotted Cabinet, Round 1/4" x 10" | 1/4 | Cabinet | 10 | Round | - | 14 | ASME B107.600 |
| JC1412R | Screwdriver, Slotted Cabinet, Round 1/4" x 12" | 1/4 | Cabinet | 12 | Round | - | 16 | ASME B107.600 |
| JC1416R | Screwdriver, Slotted Cabinet, Round 1/4" x 16" | 1/4 | Cabinet | 16 | Round | - | 20 | ASME B107.600 |
| JP0108R | Screwdriver, Phillips® Round #1 x 8" | 1 | Phillips® | 8 | Round | - | 11-3/4 | ASME B107.600 |
| JP0208R | Screwdriver, Phillips® Round #2 x 8" | 2 | Phillips® | 8 | Round | - | 12 | ASME B107.600 |
| JP0212R | Screwdriver, Phillips® Round #2 x 12" | 2 | Phillips® | 12 | Round | Yes | 16 | ASME B107.600 |
| JP0216R | Screwdriver, Phillips® Round #2 x 16" | 2 | Phillips® | 16 | Round | Yes | 20 | ASME B107.600 |



2 PIECE EXTRA-LONG COMBINATION PROTO® SCREWDRIVER SET**Product #: J1202SCXL**

- ▶ Quad-lobe features apply. (See pages 670 or 676)



Delayed Availability
Representative Image



| Contents | Description | Tip Size | Tips | Shank Length (in) (L1) | Shank Type | Overall Length (in) | ASME Spec. |
|----------|---|----------|-----------|------------------------|------------|---------------------|---------------|
| JK1424R | Screwdriver, Slotted Keystone, Round 1/4" x 24" | 1/4 | Keystone | 24 | Round | 28-1/2 | ASME B107.600 |
| JP0224R | Screwdriver, Phillips® Round #2 x 24" | 2 | Phillips® | 24 | Round | 28-1/2 | ASME B107.600 |

6 PIECE PHILLIPS® PROTO® SCREWDRIVER SET**Product #: J1206SP**

- ▶ Quad-lobe features apply. (See pages 670 or 676)



Delayed Availability
Representative Image

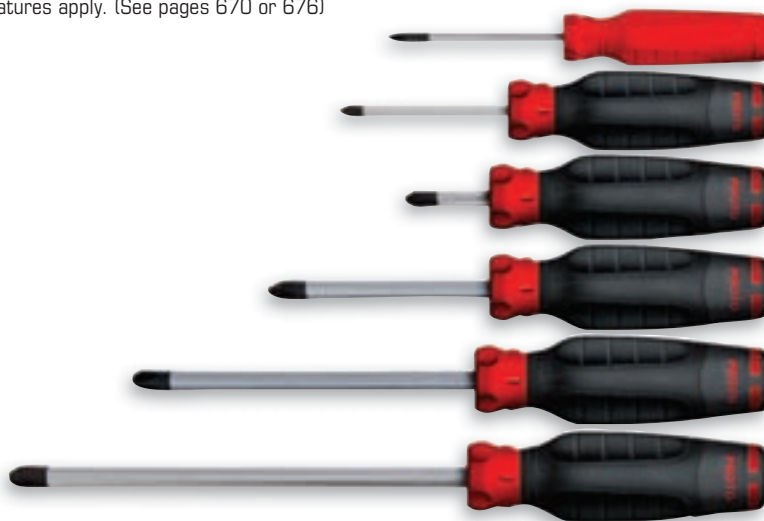

| Contents | Description | Tip Size | Tips | Shank Length (in) (L1) | Shank Type | Overall Length (in) | ASME Spec. |
|----------|--|----------|-----------|------------------------|------------|---------------------|---------------|
| JPP0003R | Screwdriver, Phillips® Round #0 x 3" | 0 | Phillips® | 3 | Round | 5-3/4 | ASME B107.600 |
| JP0103R | Screwdriver, Phillips® Round #1 x 3" | 1 | Phillips® | 3 | Round | 6-3/4 | ASME B107.600 |
| JP02112R | Screwdriver, Phillips® Round, Stubby #2 x 1-1/2" | 2 | Phillips® | 1-1/2 | Round | 3-1/2 | ASME B107.600 |
| JP0204R | Screwdriver, Phillips® Round #2 x 4" | 2 | Phillips® | 4 | Round | 8 | ASME B107.600 |
| JP0306R | Screwdriver, Phillips® Round #3 x 6" | 3 | Phillips® | 6 | Round | 10-3/8 | ASME B107.600 |
| JP0408R | Screwdriver, Phillips® Round #4 x 8" | 4 | Phillips® | 8 | Round | 13 | ASME B107.600 |



6 PIECE SLOTTED PROTO® SCREWDRIVER SET

Product #: **J1206SSF**

- › Quad-lobe features apply. (See pages 670 or 676)



Delayed Availability
Representative Image

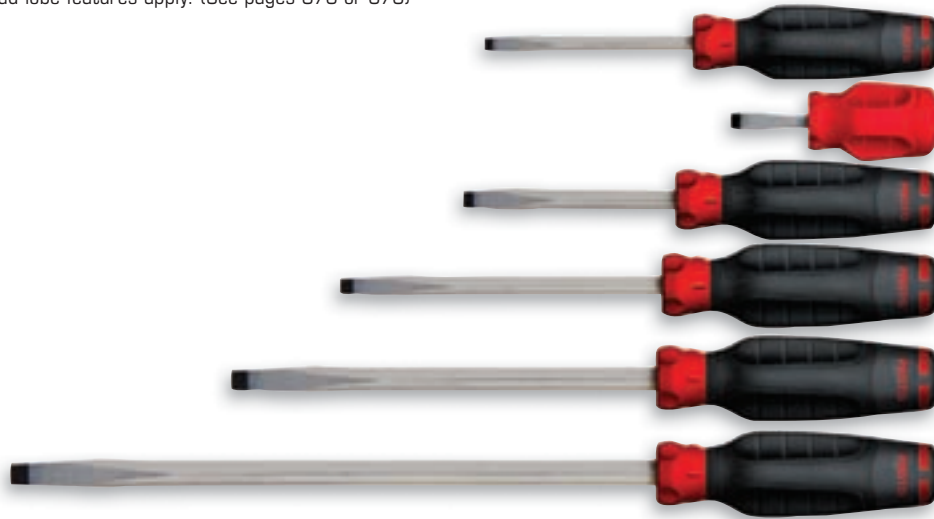

| Contents | Description | Tip Size | Tips | Shank Length (in) (L1) | Shank Type | Overall Length (in) | ASME Spec. |
|----------|--|----------|----------|------------------------|------------|---------------------|---------------|
| JK31604S | Screwdriver, Slotted Keystone, Square 3/16" x 4" | 3/16 | Keystone | 4 | Square | 7 | ASME B107.600 |
| JK14112R | Screwdriver, Slotted Keystone, Round, Stubby 1/4" x 1-1/2" | 1/4 | Keystone | 1-1/2 | Round | 3-1/2 | ASME B107.600 |
| JK1404S | Screwdriver, Slotted Keystone, Square 1/4" x 4" | 1/4 | Keystone | 4 | Square | 8 | ASME B107.600 |
| JK51606S | Screwdriver, Slotted Keystone, Square 5/16" x 6" | 5/16 | Keystone | 6 | Square | 10 | ASME B107.600 |
| JK3808S | Screwdriver, Slotted Keystone, Square 3/8" x 8" | 3/8 | Keystone | 8 | Square | 13 | ASME B107.600 |
| JK3812S | Screwdriver, Slotted Keystone, Square 3/8" x 12" | 3/8 | Keystone | 12 | Square | 17 | ASME B107.600 |

6 PIECE SLOTTED PROTO® SCREWDRIVER SET

Product #: **J1206SRF**

- › Quad-lobe features apply. (See pages 670 or 676)



Delayed Availability
Representative Image



| Contents | Description | Tip Size | Tips | Shank Length (in) (L1) | Shank Type | Overall Length (in) | ASME Spec. |
|----------|--|----------|----------|------------------------|------------|---------------------|---------------|
| JC31604R | Screwdriver, Slotted Cabinet, Round 3/16" x 4" | 3/16 | Cabinet | 4 | Round | 7 | ASME B107.600 |
| JK14112R | Screwdriver, Slotted Keystone, Round, Stubby 1/4" x 1-1/2" | 1/4 | Keystone | 1-1/2 | Round | 3-1/2 | ASME B107.600 |
| JK1404R | Screwdriver, Slotted Keystone, Round 1/4" x 4" | 1/4 | Keystone | 4 | Round | 8 | ASME B107.600 |
| JK51606R | Screwdriver, Slotted Keystone, Round 5/16" x 6" | 5/16 | Keystone | 6 | Round | 10-3/8 | ASME B107.600 |
| JK3808R | Screwdriver, Slotted Keystone, Round 3/8" x 8" | 3/8 | Keystone | 8 | Round | 13 | ASME B107.600 |
| JK3810R | Screwdriver, Slotted Keystone, Round 3/8" x 10" | 3/8 | Keystone | 10 | Round | 11 | ASME B107.600 |



9 PIECE TORX® PROTO® SCREWDRIVER SET

Product #: J1209ST

- › Quad-lobe features apply. (See pages 670 or 676)



Delayed Availability
Representative Image



| Contents | Description | Tip Size | Tips | Shank Length (in) (L1) | Shank Type | Overall Length (in) |
|----------|---------------------------------------|----------|-------|------------------------|------------|---------------------|
| JT8314R | Screwdriver, Torx® Round T8 x 3-1/2" | T8 | Torx® | 3-1/4 | Round | 7 |
| JT10314R | Screwdriver, Torx® Round T10 x 3-1/2" | T10 | Torx® | 3-1/4 | Round | 7 |
| JT15314R | Screwdriver, Torx® Round T15 x 3-1/2" | T15 | Torx® | 3-1/4 | Round | 7 |
| JT20314R | Screwdriver, Torx® Round T20 x 3-1/2" | T20 | Torx® | 3-1/4 | Round | 7 |
| JT25314R | Screwdriver, Torx® Round T25 x 3-1/2" | T25 | Torx® | 3-1/4 | Round | 7 |
| JT27314R | Screwdriver, Torx® Round T27 x 4" | T27 | Torx® | 4 | Round | 8 |
| JT30314R | Screwdriver, Torx® Round T30 x 4" | T30 | Torx® | 4 | Round | 8 |
| JT40314R | Screwdriver, Torx® Round T40 x 6" | T40 | Torx® | 6 | Round | 10-3/8 |
| JT45314R | Screwdriver, Torx® Round T45 x 6" | T45 | Torx® | 6 | Round | 10-3/8 |

FEATURES AND BENEFITS — QUAD-LOBE

- › Ergonomically designed quad-lobe handle design with 360° texture for additional grip.
- › Designed to meet demanding heavy-duty needs of industrial maintenance and assembly applications.

HANDLE

- › Impact and chemical resistant handles are four-sided with broad but shallow flutes.
- › Resistant to most harsh chemicals (including hydraulic fluids used in the aerospace industry).
- › Four-sided handle design helps prevent "roll away" from the work surface.

SHANK

- › High-alloy steel shanks are heat-treated their entire length to help provide strength against twisting action and to help prevent bending and twisting when placed under torque.
- › Fully grounded and chemically polished, then chrome plated for corrosion resistance.

TIP

- › Made of high-alloy steel (same as shank).
- › Precision machined for precise fastener fit.
- › Finished in black oxide to help prevent cam out and slipping.
- › Tips are un-plated with a black oxide finish to help prevent chrome peeling; an important Foreign Object Debris (FOD) concern.



- › Ergonomically designed handle design for improved grip



- › Black oxide tip prevents chrome peeling



4 PIECE PRECISION COMBINATION PROTO® SCREWDRIVER SET

Product #: **J1204SC**

- ▶ Quad-lobe features apply. (See pages 670 or 676)



Delayed Availability

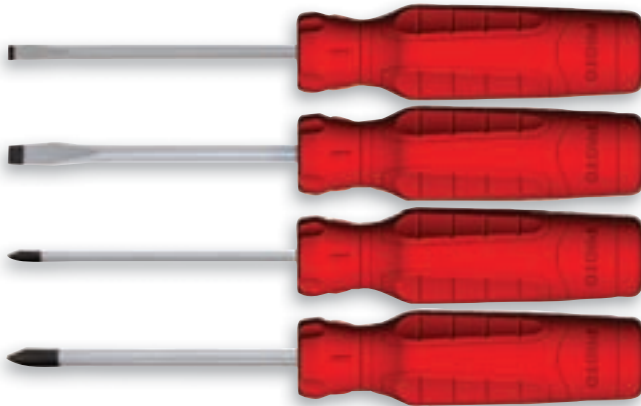

| Contents | Description | Tip Size | Tips | Shank Length (in) (L1) | Shank Type | Overall Length (in) | ASME Spec. |
|-----------|--|----------|-----------|------------------------|------------|---------------------|---------------|
| JCP1803R | Screwdriver, Slotted Cabinet, Round 1/8" x 3" | 1/8 | Cabinet | 3 | Round | 5 | ASME B107.600 |
| JCP31603R | Screwdriver, Slotted Cabinet, Round 3/16" x 3" | 3/16 | Cabinet | 3 | Round | 6-5/16 | ASME B107.600 |
| JPP0003R | Screwdriver, Phillips® Round #0 x 3" | 0 | Phillips® | 3 | Round | 5-3/4 | ASME B107.600 |
| JPP0103R | Screwdriver, Phillips® Round #1 x 3" | 1 | Phillips® | 3 | Round | 6-5/16 | ASME B107.600 |

2 PIECE PRECISION COMBINATION PROTO® SCREWDRIVER SET

Product #: **J1202SC**

- ▶ Quad-lobe features apply. (See pages 670 or 676)



Delayed Availability

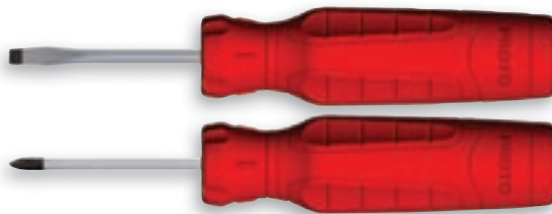

| Contents | Description | Tip Size | Tips | Shank Length (in) (L1) | Shank Type | Overall Length (in) | ASME Spec. |
|----------|---|----------|-----------|------------------------|------------|---------------------|---------------|
| JCP1802R | Screwdriver, Slotted Cabinet, Round 1/8" x 2" | 1/8 | Cabinet | 2 | Round | 4 | ASME B107.600 |
| JPP0002R | Screwdriver, Phillips® Round #0 x 2" | 0 | Phillips® | 2 | Round | 4-1/2 | ASME B107.600 |

3 PIECE SQUARE TIP PROTO® SCREWDRIVER SET

Product #: **J1203SS**

- ▶ Quad-lobe features apply. (See pages 670 or 676)



Delayed Availability

Representative Image

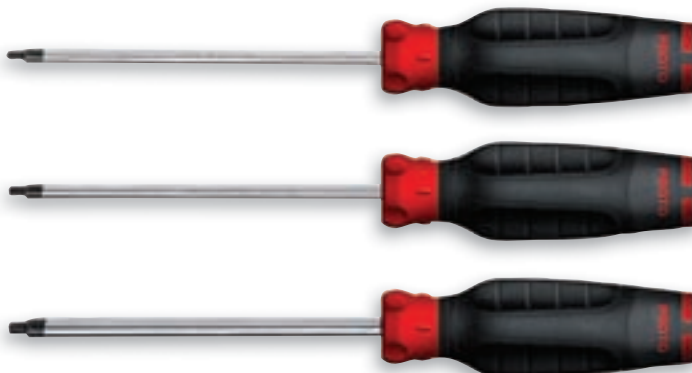

| Contents | Description | Tip Size | Tips | Shank Length (in) (L1) | Shank Type | Overall Length (in) |
|----------|----------------------------|----------|--------|------------------------|------------|---------------------|
| JSD105R | Screwdriver, Square 1 x 5" | 1 | Square | 5 | Round | 9-1/4 |
| JSD205R | Screwdriver, Square 2 x 5" | 2 | Square | 5 | Round | 9-1/4 |
| JSD305R | Screwdriver, Square 3 x 5" | 3 | Square | 5 | Round | 9-1/4 |

PROTO® SCREWDRIVERS

- › Ergonomically designed quad-lobe handle design with 360° texture for additional grip.
- › Designed to meet demanding heavy-duty needs of industrial maintenance and assembly applications.

HANDLE

- › Impact and chemical resistant handles are four-sided with broad but shallow flutes.
- › Resistant to most harsh chemicals (including hydraulic fluids used in the aerospace industry).
- › Four-sided handle design helps prevent "roll away" from the work surface.

SHANK

- › High-alloy steel shanks are heat-treated their entire length to help provide strength against twisting action and to help prevent bending and twisting when placed under torque.
- › Fully grounded and chemically polished, then chrome plated for corrosion resistance.

TIP

- › Made of high-alloy steel (same as shank).
- › Precision machined for precise fastener fit.
- › Finished in black oxide to help prevent cam out and slipping.
- › Tips are un-plated with a black oxide finish to help prevent chrome peeling; an important Foreign Object Debris (FOD) concern.

Delayed Availability
Representative Image



| Product # | Tip Size | Tips | Shank Length (in) (L1) | Shank Type | Bolster | Overall Length (in) (L) | ASME Spec. |
|-------------------|----------|-----------|------------------------|------------|---------|-------------------------|---------------|
| JK1404R | 1/4 | Keystone | 4 | Round | – | 8 | ASME B107.600 |
| JKB31603RP | 3/16 | Keystone | 3 | Round | Yes | 6-3/4 | ASME B107.600 |
| JKB51606RP | 5/16 | Keystone | 6 | Round | Yes | 10-3/8 | ASME B107.600 |
| JK51606R | 5/16 | Keystone | 6 | Round | – | 10-3/8 | ASME B107.600 |
| JK1406R | 1/4 | Keystone | 6 | Round | – | 10 | ASME B107.600 |
| JK51604R | 5/16 | Keystone | 4 | Round | – | 8-3/8 | ASME B107.600 |
| JK51608R | 5/16 | Keystone | 8 | Round | – | 12-3/8 | ASME B107.600 |
| JKB3808RP | 3/8 | Keystone | 8 | Round | Yes | 13 | ASME B107.600 |
| JK3808R | 3/8 | Keystone | 8 | Round | – | 13 | ASME B107.600 |
| JK3810R | 3/8 | Keystone | 10 | Round | – | 11 | ASME B107.600 |
| JK3812R | 3/8 | Keystone | 12 | Round | – | 17 | ASME B107.600 |
| JK1404S | 1/4 | Keystone | 4 | Square | – | 8 | ASME B107.600 |
| JK51606S | 5/16 | Keystone | 6 | Square | – | 10 | ASME B107.600 |
| JK3808S | 3/8 | Keystone | 8 | Square | – | 13 | ASME B107.600 |
| JK3812S | 3/8 | Keystone | 12 | Square | – | 17 | ASME B107.600 |
| JK31604S | 3/16 | Keystone | 4 | Square | – | 7 | ASME B107.600 |
| JCP1803R | 1/8 | Cabinet | 3 | Round | – | 5 | ASME B107.600 |
| JCP1804R | 1/8 | Cabinet | 4 | Round | – | 6 | ASME B107.600 |
| JCP1808R | 1/8 | Cabinet | 8 | Round | – | 10 | ASME B107.600 |
| JC31604R | 3/16 | Cabinet | 4 | Round | – | 7 | ASME B107.600 |
| JC31608R | 3/16 | Cabinet | 8 | Round | – | 11 | ASME B107.600 |
| JC31603R | 3/16 | Cabinet | 3 | Round | – | 6 | ASME B107.600 |
| JC31605R | 3/16 | Cabinet | 5 | Round | – | 8 | ASME B107.600 |
| JCP1802R | 1/8 | Cabinet | 2 | Round | – | 4 | ASME B107.600 |
| JC1416R | 1/4 | Cabinet | 16 | Round | – | 20 | ASME B107.600 |
| JC1412R | 1/4 | Cabinet | 12 | Round | – | 16 | ASME B107.600 |
| JC31612R | 3/16 | Cabinet | 12 | Round | – | 15 | ASME B107.600 |
| JC31610R | 3/16 | Cabinet | 10 | Round | – | 13 | ASME B107.600 |
| JC31606R | 3/16 | Cabinet | 6 | Round | – | 9 | ASME B107.600 |
| JCP1806R | 1/8 | Cabinet | 6 | Round | – | 8 | ASME B107.600 |
| JC1410R | 1/4 | Cabinet | 10 | Round | – | 14 | ASME B107.600 |
| JPP0003R | 0 | Phillips® | 3 | Round | – | 5-3/4 | ASME B107.600 |
| JPB0204RP | 2 | Phillips® | 4 | Round | Yes | 8 | ASME B107.600 |
| JPO204R | 2 | Phillips® | 4 | Round | – | 8 | ASME B107.600 |





| Product # | Tip Size | Tips | Shank Length (in) (L1) | Shank Type | Bolster | Overall Length (in) (L) | ASME Spec. |
|------------------|----------|-----------|------------------------|------------|---------|-------------------------|---------------|
| JPB0306RP | 3 | Phillips® | 6 | Round | Yes | 10-3/8 | ASME B107.600 |
| JP0306R | 3 | Phillips® | 6 | Round | – | 10-3/8 | ASME B107.600 |
| JP0408R | 4 | Phillips® | 8 | Round | – | 13 | ASME B107.600 |
| JPB0103RP | 1 | Phillips® | 3 | Round | Yes | 6-3/4 | ASME B107.600 |
| JP0103R | 1 | Phillips® | 3 | Round | – | 6-3/4 | ASME B107.600 |
| JP0108R | 1 | Phillips® | 8 | Round | – | 11-3/4 | ASME B107.600 |
| JP0208R | 2 | Phillips® | 8 | Round | – | 12 | ASME B107.600 |
| JPP0002R | 0 | Phillips® | 2 | Round | – | 4-1/2 | ASME B107.600 |
| JP0212R | 2 | Phillips® | 12 | Round | Yes | 16 | ASME B107.600 |
| JP0216R | 2 | Phillips® | 16 | Round | Yes | 20 | ASME B107.600 |
| JK14112R | 1/4 | Keystone | 1-1/2 | Round | – | 3-1/2 | ASME B107.600 |
| JP02112RP | 2 | Phillips® | 1-1/2 | Round | – | 3-1/2 | ASME B107.600 |
| JP02112R | 2 | Phillips® | 1-1/2 | Round | – | 3-1/2 | ASME B107.600 |
| JP0224R | 2 | Phillips® | 24 | Round | – | 28-1/2 | ASME B107.600 |
| JK1424R | 1/4 | Keystone | 24 | Round | – | 28-1/2 | ASME B107.600 |
| JCP31603R | 3/16 | Cabinet | 3 | Round | – | 6-5/16 | ASME B107.600 |
| JPP0103R | 1 | Phillips® | 3 | Round | – | 6-5/16 | ASME B107.600 |
| JS0105R | 1 | Square | 5 | Round | – | 9-1/4 | – |
| JS0205R | 2 | Square | 5 | Round | – | 9-1/4 | – |
| JS0305R | 3 | Square | 5 | Round | – | 9-1/4 | – |
| JT8314R | T8 | Torx® | 3-1/4 | Round | – | 7 | – |
| JT10314R | T10 | Torx® | 3-1/4 | Round | – | 7 | – |
| JT15314R | T15 | Torx® | 3-1/4 | Round | – | 7 | – |
| JT20314R | T20 | Torx® | 3-1/4 | Round | – | 7 | – |
| JT25314R | T25 | Torx® | 3-1/4 | Round | – | 7 | – |
| JT27314R | T27 | Torx® | 4 | Round | – | 8 | – |
| JT30314R | T30 | Torx® | 4 | Round | – | 8 | – |
| JT40314R | T40 | Torx® | 6 | Round | – | 10-3/8 | – |
| JT45314R | T45 | Torx® | 6 | Round | – | 10-3/8 | – |
| JKB1404RP | 1/4 | Keystone | 4 | Round | Yes | 8 | ASME B107.600 |
| JK14112RP | 1/4 | Keystone | 1-1/2 | Round | – | 3-1/2 | ASME B107.600 |



SCREWDRIVER PRODUCT NUMBER IDENTIFICATION

Proto®'s item numbering system for screwdrivers is designed to make it easy for users to identify the tool that has the size and configuration that best meets their needs.

EXAMPLE: **JPB0408RP**

Part Number Key

- **Feature Code - Series (1st Position)**
 - P = Phillips®
 - S = Square
 - H = Hex
 - C = Cabinet
 - T = Torx®
 - Z = Pozi
 - K = Keystone
 - N = Nut Driver

- **Feature Code - Series (2nd Position)**
 - B = Bolster
 - P = Precision

- **Tip Size**

- **Bar Length**

- **Feature Code - Bar Style**
 - R = Round Bar
 - S = Square Bar

- **Feature Code - Special Feature**
 - P = Polish
 - H = Hollow

19 PIECE COMBINATION SUPER PROTO® SCREWDRIVER SET

Product #: **J88819**



- › Tri-lobed handle made from Bi-Material, helps prevent hand slipping.
- › Precision machined tips for precise fastener fit.
- › Alloy steel shanks heat-treated for strength.
- › Weight (lbs): 4.65



| Contents | Description | Tip Size (B) | Shank Length (in) (L1) | Shank Type | Overall Length (in) (L) | Weight (lbs) | ASME Spec. | |
|----------|--|--------------|------------------------|------------|-------------------------|--------------|------------|---------------|
| J88203 | Screwdriver, Slotted Cabinet, Round 1/8" x 3" | 1/8 | Cabinet | 3 | Round | 6-3/8 | 0.05 | ASME B107.600 |
| J88204 | Screwdriver, Cabinet Slotted, Round 1/8" x 4" | 1/8 | Cabinet | 4 | Round | 7-1/4 | 0.05 | ASME B107.600 |
| J88208 | Screwdriver, Slotted Cabinet, Round 1/8" x 8" | 1/8 | Cabinet | 8 | Round | 12 | 0.05 | ASME B107.600 |
| J88214 | Screwdriver, Slotted Cabinet, Round 3/16" x 4" | 3/16 | Cabinet | 4 | Round | 8 | 0.14 | ASME B107.600 |
| J88218 | Screwdriver, Slotted Cabinet, Round 3/16" x 8" | 3/16 | Cabinet | 8 | Round | 12 | 0.17 | ASME B107.600 |
| J88002 | Screwdriver, Slotted Keystone, Round 1/4" x 1-1/2" | 1/4 | Keystone | 1-1/2 | Round | 3-3/4 | 0.15 | ASME B107.600 |
| J88322 | Screwdriver, Phillips® Round, Stubby #2 x 1-1/2" | 2 | Phillips® | 1-1/2 | Round | 3-3/4 | 0.10 | ASME B107.600 |
| J88393 | Screwdriver, Phillips® Round #0 x 3" | 0 | Phillips® | 3 | Round | 6-3/8 | 0.05 | ASME B107.600 |
| J88313 | Screwdriver, Phillips® Round #1 x 3" | 1 | Phillips® | 3 | Round | 6-7/8 | 0.12 | ASME B107.600 |
| J88318 | Screwdriver, Phillips® Round #1 x 8" | 1 | Phillips® | 8 | Round | 12 | 0.20 | ASME B107.600 |
| J88324 | Screwdriver, Phillips® Round #2 x 4" | 2 | Phillips® | 4 | Round | 8-1/4 | 0.21 | ASME B107.600 |
| J88328 | Screwdriver, Phillips® Round #2 x 8" | 2 | Phillips® | 8 | Round | 12-1/2 | 0.27 | ASME B107.600 |
| J88336 | Screwdriver, Phillips® Round #3 x 6" | 3 | Phillips® | 6 | Round | 10-5/16 | 0.36 | ASME B107.600 |
| J88348 | Screwdriver, Phillips® Round #4 x 8" | 4 | Phillips® | 8 | Round | 12-5/16 | 0.52 | ASME B107.600 |
| J88102 | Screwdriver, Slotted Keystone, Square 1/4" x 4" | 1/4 | Keystone | 4 | Square | 8-1/2 | 0.23 | ASME B107.600 |
| J88106 | Screwdriver, Slotted Keystone, Square 5/16" x 6" | 5/16 | Keystone | 6 | Square | 10-7/8 | 0.40 | ASME B107.600 |
| J88108 | Screwdriver, Slotted Keystone, Square 3/8" x 8" | 3/8 | Keystone | 8 | Square | 13 | 0.55 | ASME B107.600 |
| J88112 | Screwdriver, Slotted Keystone, Square 3/8" x 12" | 3/8 | Keystone | 12 | Square | 17 | 0.73 | ASME B107.600 |
| J88104 | Screwdriver, Slotted Keystone, Square 3/16" x 3" | 3/16 | Keystone | 3 | Square | 7 | 0.13 | ASME B107.600 |

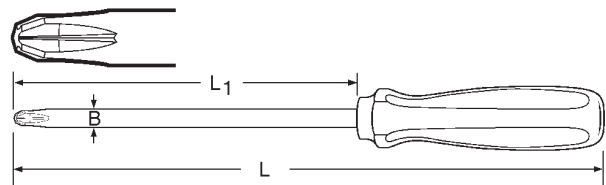

6 PIECE SLOTTED SUPER PROTO® SCREWDRIVER SET

Product #: **J88816**

- › Tri-lobed handle made from Bi-Material, helps prevent hand slipping.
- › Precision machined tips for precise fastener fit.
- › Alloy steel shanks heat-treated for strength.
- › Weight (lbs): 2.64



| Contents | Description | Tip Size (B) | Tips | Shank Length (in) (L1) | Shank Type | Overall Length (in) (L) | Weight (lbs) | ASME Spec. |
|----------|--|--------------|----------|------------------------|------------|-------------------------|--------------|---------------|
| J88002 | Screwdriver, Slotted Keystone, Round 1/4" x 1-1/2" | 1/4 | Keystone | 1-1/2 | Round | 3-3/4 | 0.15 | ASME B107.600 |
| J88102 | Screwdriver, Slotted Keystone, Square 1/4" x 1/4" | 1/4 | Keystone | 4 | Square | 8-1/2 | 0.23 | ASME B107.600 |
| J88104 | Screwdriver, Slotted Keystone, Square 3/16" x 3" | 3/16 | Keystone | 3 | Square | 7 | 0.13 | ASME B107.600 |
| J88106 | Screwdriver, Slotted Keystone, Square 5/16" x 6" | 5/16 | Keystone | 6 | Square | 10-7/8 | 0.40 | ASME B107.600 |
| J88108 | Screwdriver, Slotted Keystone, Square 3/8" x 8" | 3/8 | Keystone | 8 | Square | 13 | 0.55 | ASME B107.600 |
| J88112 | Screwdriver, Slotted Keystone, Square 3/8" x 12" | 3/8 | Keystone | 12 | Square | 17 | 0.73 | ASME B107.600 |

6 PIECE SLOTTED SUPER PROTO® SCREWDRIVER SET

Product #: **J88806**

- › Tri-lobed handle made from Bi-Material, helps prevent hand slipping.
- › Precision machined tips for precise fastener fit.
- › Alloy steel shanks heat-treated for strength.
- › Weight (lbs): 2.34



| Contents | Description | Tip Size (B) | Tips | Shank Length (in) (L1) | Shank Type | Overall Length (in) (L) | Weight (lbs) | ASME Spec. |
|----------|--|--------------|----------|------------------------|------------|-------------------------|--------------|---------------|
| J88002 | Screwdriver, Slotted Keystone, Round 1/4" x 1-1/2" | 1/4 | Keystone | 1-1/2 | Round | 3-3/4 | 0.15 | ASME B107.600 |
| J88004 | Screwdriver, Slotted Keystone, Round 1/4" x 4" | 1/4 | Keystone | 4 | Round | 8-1/4 | 0.21 | ASME B107.600 |
| J88006 | Screwdriver, Slotted Keystone, Round 5/16" x 6" | 5/16 | Keystone | 6 | Round | 10-5/16 | 0.35 | ASME B107.600 |
| J88008 | Screwdriver, Slotted Keystone, Round 3/8" x 8" | 3/8 | Keystone | 8 | Round | 12-3/4 | 0.50 | ASME B107.600 |
| J88010 | Screwdriver, Slotted Keystone, Round 3/8" x 10" | 3/8 | Keystone | 10 | Round | 14-3/4 | 0.58 | ASME B107.600 |
| J88214 | Screwdriver, Slotted Cabinet, Round 3/16" x 4" | 3/16 | Cabinet | 4 | Round | 8 | 0.14 | ASME B107.600 |



4 PIECE SLOTTED SUPER PROTO® SCREWDRIVER SET

Product #: **J88814**

- › Tri-lobed handle made from Bi-Material, helps prevent hand slipping.
- › Precision machined tips for precise fastener fit.
- › Alloy steel shanks heat-treated for strength.
- › Weight (lbs): 1.76



| Contents | Description | Tip Size (B) | Tips | Shank Length (in) (L1) | Shank Type | Overall Length (in) (L) | Weight (lbs) | ASME Spec. |
|----------|--|--------------|----------|------------------------|------------|-------------------------|--------------|---------------|
| J88103 | Screwdriver, Slotted Keystone, Square 1/4" x 3" | 1/4 | Keystone | 3 | Square | 7-1/2 | 0.23 | ASME B107.600 |
| J88104 | Screwdriver, Slotted Keystone, Square 3/16" x 3" | 3/16 | Keystone | 3 | Square | 7 | 0.13 | ASME B107.600 |
| J88106 | Screwdriver, Slotted Keystone, Square 5/16" x 6" | 5/16 | Keystone | 6 | Square | 10-7/8 | 0.40 | ASME B107.600 |
| J88108 | Screwdriver, Slotted Keystone, Square 3/8" x 8" | 3/8 | Keystone | 8 | Square | 13 | 0.55 | ASME B107.600 |

8 PIECE COMBINATION SUPER PROTO® SCREWDRIVER SET

Product #: **J88808**

- › Tri-lobed handle made from Bi-Material, helps prevent hand slipping.
- › Precision machined tips for precise fastener fit.
- › Alloy steel shanks heat-treated for strength.
- › Weight (lbs): 2.00



| Contents | Description | Tip Size (B) | Tips | Shank Length (in) (L1) | Shank Type | Overall Length (in) (L) | Weight (lbs) | ASME Spec. |
|----------|---|--------------|-----------|------------------------|------------|-------------------------|--------------|---------------|
| J88004 | Screwdriver, Slotted Keystone, Round 1/4" x 4" | 1/4 | Keystone | 4 | Round | 8-1/4 | 0.21 | ASME B107.600 |
| J88006 | Screwdriver, Slotted Keystone, Round 5/16" x 6" | 5/16 | Keystone | 6 | Round | 10-5/16 | 0.35 | ASME B107.600 |
| J88213 | Screwdriver, Slotted Cabinet, Round 3/16" x 3" | 3/16 | Cabinet | 3 | Round | 7-7/8 | 0.14 | ASME B107.600 |
| J88214 | Screwdriver, Slotted Cabinet, Round 3/16" x 4" | 3/16 | Cabinet | 4 | Round | 8 | 0.14 | ASME B107.600 |
| J88215 | Screwdriver, Slotted Cabinet, Round 3/16" x 5" | 3/16 | Cabinet | 5 | Round | 8-7/8 | 0.14 | ASME B107.600 |
| J88313 | Screwdriver, Phillips® Round #1 x 3" | 1 | Phillips® | 3 | Round | 6-7/8 | 0.12 | ASME B107.600 |
| J88324 | Screwdriver, Phillips® Round #2 x 4" | 2 | Phillips® | 4 | Round | 8-1/4 | 0.21 | ASME B107.600 |
| J88336 | Screwdriver, Phillips® Round #3 x 6" | 3 | Phillips® | 6 | Round | 10-5/16 | 0.36 | ASME B107.600 |

8 PIECE COMBINATION SUPER PROTO® BLACK SCREWDRIVER SET

Product #: **J88818B**

- ▶ Tri-lobed handle made from Bi-Material, helps prevent hand slipping.
- ▶ Precision machined tips for precise fastener fit.
- ▶ Alloy steel shanks heat-treated for strength.
- ▶ Weight (lbs): 1.87



| Contents | Description | Tip Size (B) | Tips | Shank Length (in) (L1) | Shank Type | Overall Length (in) (L) | Weight (lbs) | ASME Spec. |
|----------|---|--------------|-----------|------------------------|------------|-------------------------|--------------|---------------|
| J88004B | Screwdriver, Slotted Keystone, Round 1/4" x 4" | 1/4 | Keystone | 4 | Round | 8 | 0.12 | ASME B107.600 |
| J88006B | Screwdriver, Slotted Keystone, Round 5/16" x 6" | 5/16 | Keystone | 6 | Round | 10-5/16 | 0.20 | ASME B107.600 |
| J88203B | Screwdriver, Slotted Cabinet, Round 1/8" x 3" | 1/8 | Cabinet | 3 | Round | 6-3/8 | 0.04 | ASME B107.600 |
| J88213B | Screwdriver, Slotted Cabinet, Round 3/16" x 3" | 3/16 | Cabinet | 3 | Round | 7-7/8 | 0.13 | ASME B107.600 |
| J88216B | Screwdriver, Slotted Cabinet, Round 3/16" x 6" | 3/16 | Cabinet | 6 | Round | 9-3/4 | 0.17 | ASME B107.600 |
| J88313B | Screwdriver, Phillips® Round #1 x 3" | 1 | Phillips® | 3 | Round | 6 | 0.14 | ASME B107.600 |
| J88324B | Screwdriver, Phillips® Round #2 x 4" | 2 | Phillips® | 4 | Round | 8-1/4 | 0.21 | ASME B107.600 |
| J88336B | Screwdriver, Phillips® Round #3 x 6" | 3 | Phillips® | 6 | Round | 11 | 0.43 | ASME B107.600 |

6 PIECE PHILLIPS® SUPER PROTO® BLACK SCREWDRIVER SET

Product #: **J88837B**

- ▶ Tri-lobed handle made from Bi-Material, helps prevent hand slipping.
- ▶ Precision machined tips for precise fastener fit.
- ▶ Alloy steel shanks heat-treated for strength.
- ▶ Weight (lbs): 1.60



| Contents | Description | Tip Size (B) | Tips | Shank Length (in) (L1) | Shank Type | Overall Length (in) (L) | Weight (lbs) | ASME Spec. |
|----------|--|--------------|-----------|------------------------|------------|-------------------------|--------------|---------------|
| J88322B | Screwdriver, Phillips® Round, Stubby #2 x 1-1/2" | 2 | Phillips® | 1-1/2 | Round | 3-3/4 | 0.10 | ASME B107.600 |
| J88393B | Screwdriver, Phillips® Round #0 x 3" | 0 | Phillips® | 3 | Round | 6 | 0.05 | ASME B107.600 |
| J88313B | Screwdriver, Phillips® Round #1 x 3" | 1 | Phillips® | 3 | Round | 6 | 0.14 | ASME B107.600 |
| J88324B | Screwdriver, Phillips® Round #2 x 4" | 2 | Phillips® | 4 | Round | 8-1/4 | 0.21 | ASME B107.600 |
| J88336B | Screwdriver, Phillips® Round #3 x 6" | 3 | Phillips® | 6 | Round | 11 | 0.43 | ASME B107.600 |
| J88348B | Screwdriver, Phillips® Round #4 x 7-7/8" | 4 | Phillips® | 7-7/8 | Round | 12-3/4 | 0.60 | ASME B107.600 |

7 PIECE TORX® SUPER PROTO® BLACK SCREWDRIVER SET

Product #: **J88857**

- ▶ Tri-lobed handle made from Bi-Material, helps prevent hand slipping.
- ▶ Precision machined tips for precise fastener fit.
- ▶ Alloy steel shanks heat-treated for strength.
- ▶ Weight (lbs): 1.36



| Contents | Description | Tip Size (B) | Shank Length (in) (L1) | Overall Length (in) (L) | Weight (lbs) |
|----------|--|--------------|------------------------|-------------------------|--------------|
| J88510 | Screwdriver, Torx®, Round T10 x 3-1/4" | T10 | 3-1/4 | 7 | 0.10 |
| J88515 | Screwdriver, Torx®, Round T15 x 3-1/2" | T15 | 3-1/2 | 7-1/4 | 0.10 |
| J88520 | Screwdriver, Torx®, Round T20 x 3-3/8" | T20 | 3-3/8 | 7 | 0.10 |
| J88525 | Screwdriver, Torx®, Round T25 x 3-3/8" | T25 | 3-3/8 | 7 | 0.10 |
| J88527 | Screwdriver, Torx®, Round T27 x 4" | T27 | 4 | 8-1/2 | 0.20 |
| J88530 | Screwdriver, Torx®, Round T30 x 4-1/4" | T30 | 4-1/4 | 8-1/4 | 0.20 |
| J88540 | Screwdriver, Torx®, Round T40 x 6" | T40 | 6 | 10-3/4 | 0.30 |

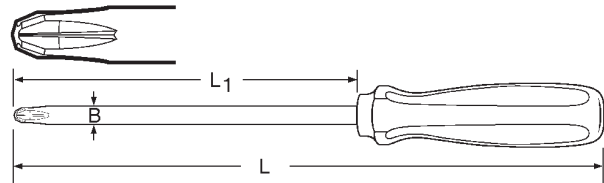

6 PIECE PHILLIPS® SUPER PROTO® SCREWDRIVER SET

Product #: **J88836**

- ▶ Tri-lobed handle made from Bi-Material, helps prevent hand slipping.
- ▶ Precision machined tips for precise fastener fit.
- ▶ Alloy steel shanks heat-treated for strength.
- ▶ Weight (lbs): 1.60



| Contents | Description | Tip Size (B) | Shank Length (in) (L1) | Overall Length (in) (L) | Weight (lbs) | ASME Spec. |
|----------|--|--------------|------------------------|-------------------------|--------------|---------------|
| J88322 | Screwdriver, Phillips® Round, Stubby #2 x 1-1/2" | 2 | 1-1/2 | 3-3/4 | 0.10 | ASME B107.600 |
| J88393 | Screwdriver, Phillips® Round #0 x 3" | 0 | 3 | 6-3/8 | 0.05 | ASME B107.600 |
| J88313 | Screwdriver, Phillips® Round #1 x 3" | 1 | 3 | 6-7/8 | 0.12 | ASME B107.600 |
| J88324 | Screwdriver, Phillips® Round #2 x 4" | 2 | 4 | 8-1/4 | 0.21 | ASME B107.600 |
| J88336 | Screwdriver, Phillips® Round #3 x 6" | 3 | 6 | 10-5/16 | 0.36 | ASME B107.600 |
| J88348 | Screwdriver, Phillips® Round #4 x 8" | 4 | 8 | 12-5/16 | 0.52 | ASME B107.600 |

SUPER PROTO® SCREWDRIVERS

- ▶ Tri-lobed handle made from Bi-Material, helps prevent hand slipping.
- ▶ Precision machined tips for precise fastener fit.
- ▶ Alloy steel shanks heat-treated for strength.



| Product # | Tip Size (B) | Tips | Shank Length (in) (L1) | Shank Type | Bolster | Overall Length (in) (L) | Weight (lbs) | ASME Spec. |
|-----------|--------------|-----------|------------------------|------------|---------|-------------------------|--------------|---------------|
| J88104 | 3/16 | Keystone | 3 | Square | – | 7 | 0.13 | ASME B107.600 |
| J88002 | 1/4 | Keystone | 1-1/2 | Round | – | 3-3/4 | 0.15 | ASME B107.600 |
| J88103 | 1/4 | Keystone | 3 | Square | – | 7-1/2 | 0.23 | ASME B107.600 |
| J88004 | 1/4 | Keystone | 4 | Round | – | 8-1/4 | 0.21 | ASME B107.600 |
| J88004B | 1/4 | Keystone | 4 | Round | – | 8 | 0.12 | ASME B107.600 |
| J88102 | 1/4 | Keystone | 4 | Square | – | 8-1/2 | 0.23 | ASME B107.600 |
| J88102B | 1/4 | Keystone | 4 | Square | – | 8-1/2 | 0.23 | ASME B107.600 |
| J88105 | 5/16 | Keystone | 5 | Square | – | 10 | 0.37 | ASME B107.600 |
| J88106 | 5/16 | Keystone | 6 | Square | – | 10-7/8 | 0.40 | ASME B107.600 |
| J88106B | 5/16 | Keystone | 6 | Square | – | 10-7/8 | 0.39 | ASME B107.600 |
| J88006 | 5/16 | Keystone | 6 | Round | – | 10-5/16 | 0.35 | ASME B107.600 |
| J88006B | 5/16 | Keystone | 6 | Round | – | 10-5/16 | 0.20 | ASME B107.600 |
| J88108 | 3/8 | Keystone | 8 | Square | – | 13 | 0.55 | ASME B107.600 |
| J88108B | 3/8 | Keystone | 8 | Square | – | 13 | 0.62 | ASME B107.600 |
| J88008 | 3/8 | Keystone | 8 | Round | – | 12-3/4 | 0.50 | ASME B107.600 |
| J88010 | 3/8 | Keystone | 10 | Round | – | 14-3/4 | 0.58 | ASME B107.600 |
| J88110 | 3/8 | Keystone | 10 | Square | – | 14-7/8 | 0.66 | ASME B107.600 |
| J88110B | 3/8 | Keystone | 10 | Square | – | 14-7/8 | 0.65 | ASME B107.600 |
| J88112 | 3/8 | Keystone | 12 | Square | – | 17 | 0.73 | ASME B107.600 |
| J88203 | 1/8 | Cabinet | 3 | Round | – | 6-3/8 | 0.05 | ASME B107.600 |
| J88203B | 1/8 | Cabinet | 3 | Round | – | 6-3/8 | 0.04 | ASME B107.600 |
| J88204 | 1/8 | Cabinet | 4 | Round | – | 7-1/4 | 0.05 | ASME B107.600 |
| J88206 | 1/8 | Cabinet | 6 | Round | – | 9-1/4 | 0.05 | ASME B107.600 |
| J88208 | 1/8 | Cabinet | 8 | Round | – | 12 | 0.05 | ASME B107.600 |
| J88213 | 3/16 | Cabinet | 3 | Round | – | 7-7/8 | 0.14 | ASME B107.600 |
| J88213B | 3/16 | Cabinet | 3 | Round | – | 7-7/8 | 0.13 | ASME B107.600 |
| J88214 | 3/16 | Cabinet | 4 | Round | – | 8 | 0.14 | ASME B107.600 |
| J88215 | 3/16 | Cabinet | 5 | Round | – | 8-7/8 | 0.14 | ASME B107.600 |
| J88216 | 3/16 | Cabinet | 6 | Round | – | 9-3/4 | 0.16 | ASME B107.600 |
| J88216B | 3/16 | Cabinet | 6 | Round | – | 9-3/4 | 0.17 | ASME B107.600 |
| J88218 | 3/16 | Cabinet | 8 | Round | – | 12 | 0.17 | ASME B107.600 |
| J88210 | 1/4 | Cabinet | 10 | Round | – | 14-3/8 | 0.28 | ASME B107.600 |
| J88393 | 0 | Phillips® | 3 | Round | – | 6-3/8 | 0.05 | ASME B107.600 |
| J88393B | 0 | Phillips® | 3 | Round | – | 6-3/8 | 0.05 | ASME B107.600 |
| J88313 | 1 | Phillips® | 3 | Round | – | 6-7/8 | 0.12 | ASME B107.600 |
| J88313B | 1 | Phillips® | 3 | Round | – | 6-7/8 | 0.14 | ASME B107.600 |
| J88318 | 1 | Phillips® | 8 | Round | – | 12 | 0.20 | ASME B107.600 |
| J88322 | 2 | Phillips® | 1-1/2 | Round | – | 3-3/4 | 0.10 | ASME B107.600 |
| J88322B | 2 | Phillips® | 1-1/2 | Round | – | 3-3/4 | 0.10 | ASME B107.600 |
| J88324 | 2 | Phillips® | 4 | Round | – | 8-1/4 | 0.21 | ASME B107.600 |
| J88324B | 2 | Phillips® | 4 | Round | – | 8-1/4 | 0.21 | ASME B107.600 |
| J88328 | 2 | Phillips® | 8 | Round | – | 12-1/2 | 0.27 | ASME B107.600 |
| J88336 | 3 | Phillips® | 6 | Round | – | 10-5/16 | 0.36 | ASME B107.600 |
| J88336B | 3 | Phillips® | 6 | Round | – | 10-5/16 | 0.43 | ASME B107.600 |
| J88348 | 4 | Phillips® | 8 | Round | – | 12-5/16 | 0.52 | ASME B107.600 |
| J88348B | 4 | Phillips® | 8 | Round | – | 12-5/16 | 0.60 | ASME B107.600 |
| J88510 | T10 | Torx® | 3-1/4 | Round | – | 7 | 0.10 | – |
| J88515 | T15 | Torx® | 3-1/2 | Round | – | 7-1/4 | 0.10 | – |
| J88520 | T20 | Torx® | 3-3/8 | Round | – | 7 | 0.10 | – |
| J88525 | T25 | Torx® | 3-3/8 | Round | – | 7 | 0.10 | – |
| J88527 | T27 | Torx® | 4 | Round | – | 8-1/2 | 0.20 | – |
| J88530 | T30 | Torx® | 4-1/4 | Round | – | 8-1/4 | 0.20 | – |
| J88540 | T40 | Torx® | 6 | Round | – | 10-3/4 | 0.30 | – |



PROTO® SOFT GRIP SLOTTED SCREWDRIVERS

- › Precision tips for tight tolerance and fastener fit.
- › Custom designed handles constructed of dual materials with hard center core for strength with cushion grip for comfort and control.
- › Blades are constructed from high-alloy steel for high-strength and performance. Plated to resist corrosion.
- › Cushion handle tapered for easy gripping and comfort.
- › Flutes designed for better turning.

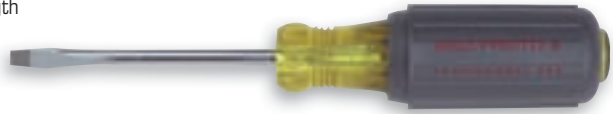

| Product # | Tip Size | Tips | Shank Length (in) (L1) | Shank Type | Overall Length (in) (L) | Weight (lbs) |
|-----------|----------|----------|------------------------|------------|-------------------------|--------------|
| J9406 | 5/16 | Keystone | 6 | Round | 10-13/32 | 0.35 |
| J9408 | 3/8 | Keystone | 8 | Round | 13-1/2 | 0.62 |
| J9403 | 3/16 | Keystone | 3 | Round | 6-3/4 | 0.17 |

ASME B107.600

PROTO® SOFT GRIP PHILLIPS® SCREWDRIVERS

- › Precision machined tips for precise fastener fit.
- › Four-sided handle with broad, shallow flutes for a firm grip and comfort.
- › Non-slip grip increases torque and maximizes comfort.
- › Blasted tips resist chrome peeling.
- › Wear-hardened for precise cross point dimensions and long life.

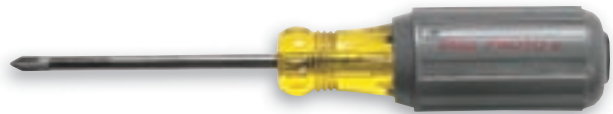

| Product # | Tip Size | Tips | Shank Type | Overall Length (in) (L) | Weight (lbs) |
|-----------|----------|-----------|------------|-------------------------|--------------|
| J9482 | 1 | Phillips® | Round | 6-3/4 | 0.17 |
| J9484 | 2 | Phillips® | Round | 8-11/32 | 0.27 |

PROTO® HEX SCREWDRIVERS



| Product # | Tip Size | Tips | Shank Length (in) (L1) | Overall Length (in) (L) | Weight (lbs) |
|-----------|----------|------|------------------------|-------------------------|--------------|
| J88601 | 3/64 | Hex | 2-3/8 | 4-51/64 | 0.03 |
| J88602 | 1/16 | Hex | 2-1/2 | 5 | 0.03 |
| J88603 | 5/64 | Hex | 2-21/32 | 5 | 0.03 |
| J88604 | 3/32 | Hex | 2-3/4 | 6-1/4 | 0.04 |
| J88605 | 7/64 | Hex | 3 | 6-1/4 | 0.04 |
| J88606 | 1/8 | Hex | 3-1/8 | 6-1/2 | 0.04 |
| J88607 | 9/64 | Hex | 3-1/4 | 6-1/2 | 0.05 |
| J88608 | 5/32 | Hex | 3-1/2 | 8 | 0.13 |
| J88609 | 3/16 | Hex | 3-3/4 | 8 | 0.14 |

FACOM® INSULATED SCREWDRIVERS



- › Designed for working on live components up to 1000V AC and 1500V DC.

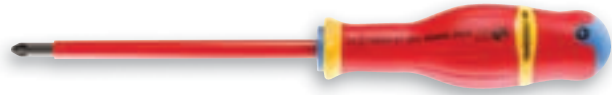

| Product # | Tip Size | Tips | Shank Length (in) (L1) | Shank Type | Overall Length (in) (L) | Weight (lbs) |
|----------------------|----------|-----------|------------------------|------------|-------------------------|--------------|
| FW-AD0X75VE | PZ0 | Pozidriv® | 3 | Round | 7 | 0.10 |
| FW-AD1X100VE | PZ1 | Pozidriv® | 4 | Round | 8-1/4 | 0.16 |
| FW-AD3X150VE | PZ3 | Pozidriv® | 6 | Round | 10-53/64 | 0.43 |
| FW-APOX75VE | 0 | Phillips® | 3 | Round | 7 | 0.10 |
| FW-AP1X100VE | 1 | Phillips® | 4 | Round | 8-1/4 | 0.16 |
| FW-AP2X125VE | 2 | Phillips® | 5 | Round | 9-3/4 | 0.28 |
| FW-AP3X150VE | 3 | Phillips® | 6 | Round | 10-3/4 | 0.43 |
| FW-AP4X200VE | 4 | Phillips® | 8 | Round | 13 | 0.61 |
| FW-A10X200VE | 10 | Cabinet | 7-7/8 | Round | 12-3/4 | 0.61 |
| FW-A12X250VE | 12 | Cabinet | 9-7/8 | Round | 14-3/4 | 0.89 |
| FW-A2.5X50VE | 2.5 mm | Cabinet | 2 | Round | 5-7/8 | 0.06 |
| FW-A2.5X75VE | 2.5 mm | Cabinet | 3 | Round | 6-7/8 | 0.06 |
| FW-A3.5X100VE | 3.5 mm | Cabinet | 4 | Round | 7-7/8 | 0.12 |
| FW-A3.5X75VE | 3.5 mm | Cabinet | 3 | Round | 6-7/8 | 0.11 |
| FW-A3X75VE | 3 mm | Cabinet | 3 | Round | 6-7/8 | 0.10 |
| FW-A4X100VE | 4 mm | Cabinet | 4 | Round | 7-7/8 | 0.16 |
| FW-A4X150VE | 4 mm | Cabinet | 5-7/8 | Round | 9-7/8 | 0.17 |
| FW-A5.5X125VE | 5.5 mm | Cabinet | 5 | Round | 8-7/8 | 0.20 |
| FW-A5.5X150VE | 5.55 mm | Cabinet | 5-7/8 | Round | 10-1/8 | 0.21 |
| FW-A5.5X200VE | 5.5 mm | Cabinet | 7-7/8 | Round | 12-1/2 | 0.21 |
| FW-A6.5X150VE | 6.5 mm | Cabinet | 5-7/8 | Round | 10-1/2 | 0.31 |
| FW-A6.5X200VE | 6.5 mm | Cabinet | 7-7/8 | Round | 12-1/2 | 0.35 |
| FW-A8X150VE | 8 mm | Cabinet | 5-7/8 | Round | 10-1/2 | 0.43 |
| FW-A8X200VE | 8 mm | Cabinet | 7-7/8 | Round | 12-3/4 | 0.48 |

FACOM® 8 PIECE 1000V INSULATED SCREWDRIVER SET



Product #: FW-MOD.A1VE

- › Set includes: PZ1, PZ2, 1, 2, 3.5 mm, 4 mm, 5.5 mm, and 6.5 mm sizes.
- › Designed for working on live components up to 1000V AC and 1500V DC.
- › Ergonomically designed, Bi-Material handle.
- › Strong, comfortable grip for high torque action.
- › Carbon silicon steel blade for strength.
- › Black tip to retain the dimensional accuracy of the machined tip.
- › Weight (lbs): 2.34



| Contents | Description | Tip Size | Tips | Shank Length (in) (L1) | Shank Type | Overall Length (in) (L) | Weight (lbs) |
|---------------|--|----------|-----------|------------------------|------------|-------------------------|--------------|
| FW-A3.5X100VE | Screwdriver, Round Bar Slotted 3.5 mm x 4" | 3.5 mm | Cabinet | 4 | Round | 7-7/8 | 0.12 |
| FW-A4X100VE | Screwdriver, Round Bar Slotted 4 mm x 4" | 4 mm | Cabinet | 4 | Round | 7-7/8 | 0.16 |
| FW-A5.5X125VE | Screwdriver, Round Bar Slotted 5.5 mm x 5" | 5.5 mm | Cabinet | 5 | Round | 8-7/8 | 0.20 |
| FW-A6.5X150VE | Screwdriver, Round Bar Slotted 6.5 mm x 5-7/8" | 6.5 mm | Cabinet | 5-7/8 | Round | 10-1/2 | 0.31 |
| FW-AP1X100VE | Screwdriver, Round Bar #1 x 4" | 1 | Phillips® | 4 | Round | 8-1/4 | 0.16 |
| FW-AP2X125VE | Screwdriver, Round Bar #2 x 5" | 2 | Phillips® | 5 | Round | 9-3/4 | 1.50 |
| FW-AD1X100VE | Screwdriver, Pozidriv® Round Bar PZ1 x 4" | PZ1 | Pozidriv® | 4 | Round | 8-1/4 | 0.16 |
| - | Screwdriver, Pozidriv® Round Bar PZ2 x 5" | PZ2 | Pozidriv® | 5 | Round | 9-3/4 | 1.50 |



PHILLIPS® HEX INSERT BITS

| Product # | Tips | Tip Size | Drive Size (in) | Overall Length (in) | Weight (lbs) |
|-----------|-----------|----------|-----------------|---------------------|--------------|
| J60002 | Phillips® | 1 | 1/4 | 1 | 0.01 |
| J60008 | Phillips® | 2 | 1/4 | 1 | 0.01 |
| J60020 | Phillips® | 3 | 1/4 | 1 | 0.01 |
| J60050 | Phillips® | 1 | 5/16 | 1-1/4 | 0.02 |
| J60052 | Phillips® | 2 | 5/16 | 1-1/4 | 0.02 |
| J60054 | Phillips® | 3 | 5/16 | 1-1/4 | 0.03 |



PHILLIPS® ACR® INSERT BITS

| Product # | Tips | Tip Size | Drive Size (in) | Overall Length (in) | Weight (lbs) |
|-----------|-----------|----------|-----------------|---------------------|--------------|
| J60004 | Phillips® | 1 | 1/4 | 1 | 0.01 |
| J60010 | Phillips® | 2 | 1/4 | 1 | 0.01 |
| J60022 | Phillips® | 3 | 1/4 | 1 | 0.01 |



PHILLIPS® POWER INSERT BITS

| Product # | Tips | Tip Size | Drive Size (in) | Overall Length (in) | Weight (lbs) |
|-----------|---------------------|----------|-----------------|---------------------|--------------|
| J60100 | Phillips® Power Bit | 1 | 1/4 | 1-15/16 | 0.02 |
| J60102 | Phillips® Power Bit | 2 | 1/4 | 1-15/16 | 0.02 |
| J60014 | Phillips® Power Bit | 2 | 1/4 | 1-1/2 | 0.02 |
| J60116 | Phillips® Power Bit | 2 | 1/4 | 2-51/64 | 0.03 |
| J60018 | Phillips® Power Bit | 2 | 1/4 | 3-45/64 | 0.03 |



SLOTTED HEX INSERT BITS

| Product # | Tips | Tip Size | Drive Size (in) | Overall Length (in) | Weight (lbs) |
|-----------|---------|----------|-----------------|---------------------|--------------|
| J60200 | Slotted | 5/32 | 1/4 | 1 | 0.01 |
| J60202 | Slotted | 3/16 | 1/4 | 1 | 0.01 |
| J60204 | Slotted | 7/32 | 1/4 | 1 | 0.01 |
| J60206 | Slotted | 5/32 | 1/4 | 1 | 0.01 |
| J60208 | Slotted | 9/32 | 1/4 | 1 | 0.01 |
| J60256 | Slotted | 3/8 | 5/16 | 1-1/2 | 0.03 |
| J60262 | Slotted | 3/8 | 5/16 | 1-1/2 | 0.03 |





TORX® HEX INSERT BITS

› Not for use on impact applications.

| Product # | Tips | Tip Size | Drive Size (in) | Overall Length (in) | Weight (lbs) |
|-----------|-------|----------|-----------------|---------------------|--------------|
| J60500 | Torx® | T6 | 1/4 | 1 | 0.01 |
| J60502 | Torx® | T7 | 1/4 | 1 | 0.01 |
| J60504 | Torx® | T8 | 1/4 | 1 | 0.01 |
| J60506 | Torx® | T9 | 1/4 | 1 | 0.01 |
| J60508 | Torx® | T10 | 1/4 | 1 | 0.01 |
| J60510 | Torx® | T15 | 1/4 | 1 | 0.01 |
| J60512 | Torx® | T20 | 1/4 | 1 | 0.01 |
| J60514 | Torx® | T25 | 1/4 | 1 | 0.01 |
| J60516 | Torx® | T27 | 1/4 | 1 | 0.01 |
| J60518 | Torx® | T30 | 1/4 | 1 | 0.01 |
| J60520 | Torx® | T40 | 1/4 | 1 | 0.02 |
| J60560 | Torx® | T30 | 5/16 | 1.5 | 0.02 |
| J60562 | Torx® | T40 | 5/16 | 1 | 0.02 |
| J60564 | Torx® | T45 | 5/16 | 1 | 0.03 |
| J60566 | Torx® | T50 | 5/16 | 1 | 0.03 |
| J60568 | Torx® | T55 | 5/16 | 1.3 | 0.04 |



TORX® TAMPER-PROOF HEX INSERT BITS

› Not for use on impact applications.

| Product # | Tips | Tip Size | Drive Size (in) | Overall Length (in) | Weight (lbs) |
|-----------|--------------------|----------|-----------------|---------------------|--------------|
| J60530 | Tamper-Proof Torx® | T10H | 1/4 | 1 | 0.01 |
| J60532 | Tamper-Proof Torx® | T15H | 1/4 | 1 | 0.01 |
| J60534 | Tamper-Proof Torx® | T20H | 1/4 | 1 | 0.01 |
| J60536 | Tamper-Proof Torx® | T25H | 1/4 | 1 | 0.01 |
| J60538 | Tamper-Proof Torx® | T27H | 1/4 | 1 | 0.01 |
| J60540 | Tamper-Proof Torx® | T30H | 1/4 | 1 | 0.01 |
| J60542 | Tamper-Proof Torx® | T40H | 1/4 | 1 | 0.01 |



SQUARE HEX INSERT BITS

| Product # | Tips | Tip Size | Drive Size (in) | Overall Length (in) | Weight (lbs) |
|-----------|--------|----------|-----------------|---------------------|--------------|
| J61002 | Square | 1 | 1/4 | 1 | 0.01 |
| J61004 | Square | 2 | 1/4 | 1 | 0.01 |
| J61006 | Square | 3 | 1/4 | 1 | 0.01 |



BIT HOLDERS

› Not for use on impact applications.

| Product # | Drive Size (in) | Overall Length (in) | Weight (lbs) |
|-----------|-----------------|---------------------|--------------|
| J61200 | 1/4 | 2-1/4 | 0.04 |
| J61204 | 1/4 | 4 | 0.12 |



MAGNETIC BIT HOLDERS

- › Magnetic to hold the bit in place.

| Product # | Drive Size (in) | Overall Length (in) | Weight (lbs) |
|---------------|-----------------|---------------------|--------------|
| J61222 | 1/4 | 2-1/4 | 0.07 |
| J61223 | 1/4 | 2-31/32 | 0.08 |
| J61234 | 1/4 | 2-1/4 | 0.05 |
| J61236 | 1/4 | 3 | 0.06 |
| J61238 | 1/4 | 3 | 0.10 |
| J61224 | 1/4 | 4 | 0.12 |
| J61226 | 1/4 | 6 | 0.20 |



MAGNETIC SCREWDRIVER BIT HOLDER

- › Extra long handle allows greater access to confined, restricted areas.
- › Convenient bit storage in handle.

| Product # | Drive Size (in) | Overall Length (in) | Weight (lbs) |
|----------------|-----------------|---------------------|--------------|
| J9300MS | 1/4 | 7-9/16 | 0.15 |
| J9300MX | 1/4 | 11-5/16 | 0.30 |

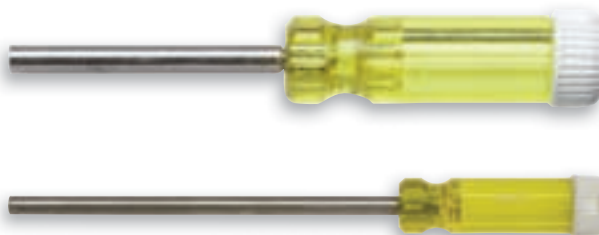

POWER BIT HOLDER

- › Not for use on impact applications.

| Product # | Drive Size (in) | Hex Size (in) | Overall Length (in) | Weight (lbs) |
|--------------|-----------------|---------------|---------------------|--------------|
| J6925 | 1/4 | 1/4 | 1 | 0.04 |
| J6931 | 3/8 | 1/4 | 1-3/4 | 0.07 |
| J6930 | 3/8 | 5/16 | 1-5/16 | 0.07 |
| J6935 | 1/2 | 5/16 | 1-1/2 | 0.11 |



EXTENSIONS

- › Made of forged steel.
- › Size stamped on tool for easy identification.
- › Ball detent.

| Product # | Tips | Drive Size (in) | Male Square | Style | Overall Length (in) | Weight (lbs) |
|---------------|--------|-----------------|-------------|-------|---------------------|--------------|
| J61302 | Square | 1/4 Hex | 1/4 | Pin | 2 | 0.04 |
| J61303 | Square | 1/4 Hex | 1/4 | Pin | 3 | 0.05 |
| J61304 | Square | 1/4 Hex | 1/4 | Pin | 4 | 0.08 |
| J61306 | Square | 1/4 Hex | 1/4 | Pin | 6 | 0.12 |
| J61352 | Square | 1/4 Hex | 1/4 | Ball | 2 | 0.04 |
| J61402 | Square | 1/4 Hex | 3/8 | Pin | 2 | 0.05 |
| J61404 | Square | 1/4 Hex | 3/8 | Pin | 4 | 0.13 |
| J61406 | Square | 1/4 Hex | 3/8 | Pin | 6 | 0.13 |
| J61502 | Square | 7/16 Hex | 3/8 | Ball | 2 | 0.05 |



EXTENSIONS - 7/16" HEX SHANK

- › Made of forged steel.
- › Size stamped on tool for easy identification.
- › Ball detent.
- › Not for use on impact applications.



| Product # | Tips | Drive Size (in) | Male Square | Style | Overall Length (in) | Weight (lbs) |
|--------------|--------|-----------------|-------------|-------|---------------------|--------------|
| J7111 | Square | 7/16 Hex | 3/8 | Pin | 2-3/4 | 0.14 |
| J7121 | Square | 7/16 Hex | 1/2 | Pin | 2-3/4 | 0.17 |

28 PIECE MAGNETIC SCREWDRIVER BIT SET

Product #: J61929

- › Packaged in plastic blow-molded case for easy storage.
- › Weight (lbs): 1.07



| Description | Tip Size | Tips | Overall Length (in) | Drive Size (in) |
|---------------------------------------|----------|-----------|---------------------|-----------------|
| Bit, Insert #0 Phillips® 1/4" Hex | 0 | Phillips® | 1 | 1/4 |
| Bit, Insert #1 Phillips® 1/4" Hex | 1 | Phillips® | 1 | 1/4 |
| Bit, Insert #2 Phillips® 1/4" Hex | 2 | Phillips® | 1 | 1/4 |
| Bit, Insert #3 Phillips® 1/4" Hex | 3 | Phillips® | 1 | 1/4 |
| Bit, Insert Slotted 3F-4R 1/4" Hex | 3F-4R | Slotted | 1 | 1/4 |
| Bit, Insert Slotted 4F-5R 1/4" Hex | 4F-5R | Slotted | 1 | 1/4 |
| Bit, Insert 7/32" Slotted 1/4" Hex | 7/32 | Slotted | 1 | 1/4 |
| Bit, Insert 5/32" Slotted 1/4" Hex | 5/32 | Slotted | 1 | 1/4 |
| Bit, Insert 9/32" Slotted 1/4" Hex | 9/32 | Slotted | 1 | 1/4 |
| Bit, Insert T10 Torx® 1/4" Hex | T10 | Torx® | 1 | 1/4 |
| Bit, Insert T15 Torx® 1/4" Hex | T15 | Torx® | 1 | 1/4 |
| Bit, Insert T20 Torx® 1/4" Hex | T20 | Torx® | 1 | 1/4 |
| Bit, Insert T25 Torx® 1/4" Hex | T25 | Torx® | 1 | 1/4 |
| Bit, Insert T30 Torx® 1/4" Hex | T30 | Torx® | 1 | 1/4 |
| Bit, Insert T40 Torx® 1/4" Hex | T40 | Torx® | 1 | 1/4 |
| Bit, Insert #0 Square Recess 1/4" Hex | 0 | Square | 1 | 1/4 |
| Bit, Insert #1 Square Recess 1/4" Hex | 1 | Square | 1 | 1/4 |
| Bit, Insert #2 Square Recess 1/4" Hex | 2 | Square | 1 | 1/4 |
| Bit, Insert #3 Square Recess 1/4" Hex | 3 | Square | 1 | 1/4 |
| 5/64" Socket Head, 1/4" Hex | 5/64 | Socket | 1 | 1/4 |
| 3/32" Socket Head, 1/4" Hex | 3/32 | Socket | 1-1/4 | 1/4 |
| 1/8" Socket Head, 1/4" Hex | 1/8 | Socket | 1-1/4 | 1/4 |
| 5/32" Socket Head, 1/4" Hex | 5/32 | Socket | 1-1/4 | 1/4 |
| 3/16" Socket Head, 1/4" Hex | 3/16 | Socket | 1-1/4 | 1/4 |
| Bit, Insert 1/8" Clutch, 1/4" Hex | 1/8 | Clutch | 1 | 1/4 |
| Bit, Insert 5/32" Clutch, 1/4" Hex | 5/32 | Clutch | 1 | 1/4 |
| Magnetic Bit, Holder | | | 2-1/4 | 1/4 |
| Screwdriver, Magnetic Bit, Holder | | | 7-9/16 | 1/4 |

11 PIECE MAGNETIC RATCHETING SCREWDRIVER BIT SET

Product #: J9322



- › Gearless Ratcheting Screwdriver provides smooth operation, infinite ratcheting angle.
- › Convenient bit storage in handle.
- › Weight (lbs): 0.76



| Contents | Description | Tip Size | Tips | Overall Length (in) | Drive Size (in) |
|----------|------------------------------------|----------|-----------|---------------------|-----------------|
| J60002 | Bit, Insert #1 Phillips® 1/4" Hex | 1 | Phillips® | 1 | 1/4 |
| J60008 | Bit, Insert #2 Phillips® 1/4" Hex | 2 | Phillips® | 1 | 1/4 |
| J60202 | Bit, Insert 3/16" Slotted 1/4" Hex | 3/16 | Slotted | 1 | 1/4 |
| J60206 | Bit, Insert 5/32" Slotted 1/4" Hex | 5/32 | Slotted | 1 | 1/4 |
| | Nut Setters Magnetic, 3/16" | | | 1-1/2 | 1/4 |
| | Nut Setters Magnetic, 1/4" | | | 1-1/2 | 1/4 |
| | Nut Setters Magnetic, 9/32" | | | 1-1/2 | 1/4 |
| | Nut Setters Magnetic, 5/16" | | | 1-1/2 | 1/4 |
| | Nut Setters Magnetic, 11/32" | | | 1-1/2 | 1/4 |
| | Nut Setters Magnetic, 7/16" | | | 1-1/2 | 1/4 |
| | Screwdriver, Magnetic Ratcheting | | | 8-3/4 | 1/4 |

5 PIECE MAGNETIC RATCHETING SCREWDRIVER BIT SET

Product #: J9320



- › Gearless Ratcheting Screwdriver provides smooth operation, infinite ratcheting angle.
- › Convenient bit storage in handle.
- › Weight (lbs): 0.50



| Contents | Description | Tip Size | Tips | Overall Length (in) | Drive Size (in) |
|----------|------------------------------------|----------|-----------|---------------------|-----------------|
| J60002 | Bit, Insert #1 Phillips® 1/4" Hex | 1 | Phillips® | 1 | 1/4 |
| J60008 | Bit, Insert #2 Phillips® 1/4" Hex | 2 | Phillips® | 1 | 1/4 |
| J60202 | Bit, Insert 3/16" Slotted 1/4" Hex | 3/16 | Slotted | 1 | 1/4 |
| J60206 | Bit, Insert 5/32" Slotted 1/4" Hex | 5/32 | Slotted | 1 | 1/4 |
| | Screwdriver, Magnetic Ratcheting | | | 8-3/4 | 1/4 |

5 PIECE MAGNETIC SCREWDRIVER BIT SET—LONG REACH

Product #: J9224



- › Extra long handle allows greater access to confined, restricted areas.
- › Convenient bit storage in handle.
- › Weight (lbs): 0.38



| Contents | Description | Tip Size | Tips | Overall Length (in) | Drive Size (in) |
|----------|--|----------|-----------|---------------------|-----------------|
| J60002 | Bit, Insert #1 Phillips® 1/4" Hex | 1 | Phillips® | 1 | 1/4 |
| J60008 | Bit, Insert #2 Phillips® 1/4" Hex | 2 | Phillips® | 1 | 1/4 |
| J60202 | Bit, Insert 3/16" Slotted 1/4" Hex | 3/16 | Slotted | 1 | 1/4 |
| J60206 | Bit, Insert 5/32" Slotted 1/4" Hex | 5/32 | Slotted | 1 | 1/4 |
| J9300MX | Screwdriver, Magnetic Bit, Holder - Long Reach | | | 11-5/16 | 1/4 |



38 PIECE INSERT/POWER BIT SET

Product #: J61906

- › Magnetic base provides tool organization as well as portability.
- › Strong magnetic bond allows for superior holding strength.
- › Holder allows bits to remain organized in a tool box drawer as well as on any metal surface.
- › Mixed assortment of standard, slotted, Phillips®, and Torx® tips and clutches to help in a variety of tasks.
- › Weight (lbs): 1.21



| Description | Tip Size | Tips | Overall Length (in) | Drive Size (in) |
|--|----------|-----------|---------------------|-----------------|
| Bit, Insert #0 Phillips® 1/4" Hex | 0 | Phillips® | 1 | 1/4 |
| Bit, Insert #1 Phillips® 1/4" Hex | 1 | Phillips® | 1 | 1/4 |
| Bit, Insert #2 Phillips® 1/4" Hex | 2 | Phillips® | 1 | 1/4 |
| Bit, Insert #3 Phillips® 1/4" Hex | 3 | Phillips® | 1 | 1/4 |
| Bit, Insert #2 Phillips® 1/4" Hex (Reduced Dia.) | 2 | Phillips® | 1 | 1/4 |
| Bit, Insert #1 PZ 1/4" Hex | 1 | Pozidriv® | 1 | 1/4 |
| Bit, Insert #2 PZ 1/4" Hex | 2 | Pozidriv® | 1 | 1/4 |
| Bit, Insert Slotted 1/4" Hex | 4F-5R | Slotted | 1 | 1/4 |
| Bit, Insert Slotted 1/4" Hex | 6F-8R | Slotted | 1 | 1/4 |
| Bit, Insert Slotted 1/4" Hex | 8F-10R | Slotted | 1 | 1/4 |
| Bit, Insert Slotted 1/4" Hex | 10F-12R | Slotted | 1 | 1/4 |
| Bit, Insert Slotted 1/4" Hex | 12F-14R | Slotted | 1-1/2 | 1/4 |
| Bit, Insert Slotted 1/4" Hex | 14F-16R | Slotted | 1-1/2 | 1/4 |
| Bit, Insert T6 Torx® 1/4" Hex | T6 | Torx® | 1 | 1/4 |
| Bit, Insert T7 Torx® 1/4" Hex | T7 | Torx® | 1 | 1/4 |
| Bit, Insert T8 Torx® 1/4" Hex | T8 | Torx® | 1 | 1/4 |
| Bit, Insert T9 Torx® 1/4" Hex | T9 | Torx® | 1 | 1/4 |
| Bit, Insert T10 Torx® 1/4" Hex | T10 | Torx® | 1 | 1/4 |
| Bit, Insert T15 Torx® 1/4" Hex | T15 | Torx® | 1 | 1/4 |
| Bit, Insert T20 Torx® 1/4" Hex | T20 | Torx® | 1 | 1/4 |
| Bit, Insert T25 Torx® 1/4" Hex | T25 | Torx® | 1 | 1/4 |
| Bit, Insert T30 Torx® 1/4" Hex | T30 | Torx® | 1 | 1/4 |
| Bit, Insert T40 Torx® 1/4" Hex | T40 | Torx® | 1 | 1/4 |
| 3/32" Socket Head, 1/4" Hex | 3/32 | Socket | 1-1/4 | 1/4 |
| 7/64" Socket Head, 1/4" Hex | 7/64 | Socket | 1-1/4 | 1/4 |
| 1/8" Socket Head, 1/4" Hex | 1/8 | Socket | 1-1/4 | 1/4 |
| 9/64" Socket Head, 1/4" Hex | 9/64 | Socket | 1-1/4 | 1/4 |
| 5/32" Socket Head, 1/4" Hex | 5/32 | Socket | 1-1/4 | 1/4 |
| 3/16" Socket Head, 1/4" Hex | 3/16 | Socket | 1-1/4 | 1/4 |
| Bit, Insert #0 Square Recess 1/4" Hex | 0 | Square | 1 | 1/4 |
| Bit, Insert #1 Square Recess 1/4" Hex | 1 | Square | 1 | 1/4 |
| Bit, Insert #2 Square Recess 1/4" Hex | 2 | Square | 1 | 1/4 |
| Bit, Insert #3 Square Recess 1/4" Hex | 3 | Square | 1 | 1/4 |
| Bit, Insert 1/8" Clutch, 1/4" Hex | 1/8 | Clutch | 1 | 1/4 |
| Bit, Insert 5/32" Clutch, 1/4" Hex | 5/32 | Clutch | 1 | 1/4 |
| Bit, Insert 3/16" Clutch, 1/4" Hex | 3/16 | Clutch | 1 | 1/4 |
| Bit, Holder Magnetic 1/4" Hex | | | 2-1/4 | 1/4 |
| Bit, Holder Power 1/4" DR 1/4" Hex | | | 1 | 1/4 |



10 PIECE INSERT BIT SET WITH STORAGE BOX

Product #: **J61901**

- › Popular bits in compact storage box which doubles as a screwdriver handle.
- › Bits are power tool rated and can be used with Cordless and Electric Drills.
- › Weight (lbs): 0.39



| Contents | Description | Tip Size | Tips | Overall Length (in) | Drive Size (in) |
|----------|------------------------------------|----------|-----------|---------------------|-----------------|
| J60002 | Bit, Insert #1 Phillips® 1/4" Hex | 1 | Phillips® | 1 | 1/4 |
| J60008 | Bit, Insert #2 Phillips® 1/4" Hex | 2 | Phillips® | 1 | 1/4 |
| J60020 | Bit, Insert #3 Phillips® 1/4" Hex | 3 | Phillips® | 1 | 1/4 |
| J60202 | Bit, Insert 3/16" Slotted 1/4" Hex | 3/16 | Slotted | 1 | 1/4 |
| J60206 | Bit, Insert 5/32" Slotted 1/4" Hex | 5/32 | Slotted | 1 | 1/4 |
| J60216 | Bit, Insert 7/32" Slotted 1/4" Hex | 7/32 | Slotted | 1 | 1/4 |
| J60508 | Bit, Insert T10 Torx® 1/4" Hex | T10 | Torx® | 1 | 1/4 |
| J60510 | Bit, Insert T15 Torx® 1/4" Hex | T15 | Torx® | 1 | 1/4 |
| J60808 | 1/8" Socket Head, 1/4" Hex | 1/8 | Socket | 1-1/4 | 1/4 |
| J61223 | Bit, Holder Magnetic 1/4" Hex | | | 2-31/32 | 1/4 |

11 PIECE 1/4" AND 3/8" DRIVE TORX® BIT SET

Product #: **J5239P**

- › T10 to T50, 2 Bit Holders, with Pouch.
- › Not for use on impact application.
- › 1/4" and 3/8" drive, 1/4" and 5/16" hex.
- › Weight (lbs): 0.36



| Contents | Description | Tip Size | Tips | Overall Length (in) | Drive Size (in) |
|----------|-------------------------------------|----------|-------|---------------------|-----------------|
| J60508 | Bit, Insert T10 Torx® 1/4" Hex | T10 | Torx® | 1 | 1/4 |
| J60510 | Bit, Insert T15 Torx® 1/4" Hex | T15 | Torx® | 1 | 1/4 |
| J60512 | Bit, Insert T20 Torx® 1/4" Hex | T20 | Torx® | 1 | 1/4 |
| J60514 | Bit, Insert T25 Torx® 1/4" Hex | T25 | Torx® | 1 | 1/4 |
| J60516 | Bit, Insert T27 Torx® 1/4" Hex | T27 | Torx® | 1 | 1/4 |
| J60518 | Bit, Insert T30 Torx® 1/4" Hex | T30 | Torx® | 1 | 1/4 |
| J60562 | Bit, Insert T40 Torx® 5/16" Hex | T40 | Torx® | 1 | 5/16 |
| J60564 | Bit, Insert T45 Torx® 5/16" Hex | T45 | Torx® | 1 | 5/16 |
| J60566 | Bit, Insert T50 Torx® 5/16" Hex | T50 | Torx® | 1 | 5/16 |
| J6930 | Bit, Holder Power 3/8" DR 5/16" Hex | | | 1-5/16 | 1/4 |
| J6931 | Bit, Holder Power 3/8" DR 1/4" Hex | | | 1-1/4 | 1/4 |
| J25TR50C | Pouch | | | 6-1/3 | |



7 PIECE 3/8" DRIVE TORX® BIT SET

Product #: J4739P

- › Not for use on impact applications.
- › 3/8" drive and 5/16" hex
- › Weight (lbs): 0.19



| Contents | Description | Tip Size | Tips | Overall Length (in) | Drive Size (in) |
|----------|------------------------------------|----------|-------|---------------------|-----------------|
| J60508 | Bit, Insert T10 Torx® 1/4" Hex | T10 | Torx® | 1 | 1/4 |
| J60510 | Bit, Insert T15 Torx® 1/4" Hex | T15 | Torx® | 1 | 1/4 |
| J60512 | Bit, Insert T20 Torx® 1/4" Hex | T20 | Torx® | 1 | 1/4 |
| J60514 | Bit, Insert T25 Torx® 1/4" Hex | T25 | Torx® | 1 | 1/4 |
| J60516 | Bit, Insert T27 Torx® 1/4" Hex | T27 | Torx® | 1 | 1/4 |
| J60518 | Bit, Insert T30 Torx® 1/4" Hex | T30 | Torx® | 1 | 1/4 |
| J6931 | Bit, Holder Power 3/8" DR 1/4" Hex | | | 1-1/4 | 1/4 |
| J25TR50C | Pouch | | | 6-1/3 | |

SLOTTED SCREW STARTERS

- › Pocket clip.

| Product # | Overall Length (in) | Weight (lbs) |
|--------------|---------------------|--------------|
| J9851 | 2-5/8 | 0.02 |
| J9853 | 5-5/8 | 0.04 |
| J9855 | 9-5/8 | 0.09 |



PHILLIPS® SCREW STARTERS

- › Pocket clip.

| Product # | Overall Length (in) | Weight (lbs) |
|--------------|---------------------|--------------|
| J9882 | 2-3/4 | 0.02 |
| J9884 | 5-3/4 | 0.05 |
| J9886 | 9-3/4 | 0.06 |



COMBINATION SCREW STARTERS

- › Pocket clip.

| Product # | Overall Length (in) | Weight (lbs) |
|--------------|---------------------|--------------|
| J9866 | 6-1/4 | 0.04 |



MAGNETIZER/DEMAGNITIZER

- › Use for screwdrivers.

| Product # | Weight (lbs) |
|--------------|--------------|
| J9888 | 0.14 |



SLOTTED OFFSET SCREWDRIVERS

- ▶ Black oxide finish.

| Product # | Tip Width (in) | Overall Length (in) | Weight (lbs) |
|----------------|----------------|---------------------|--------------|
| J361/4 | 1/4 | 4-5/8 | 0.05 |
| J365/16 | 5/16 | 4-7/8 | 0.13 |
| J363/8 | 3/8 | 6-1/8 | 0.12 |



PHILLIPS® OFFSET SCREWDRIVERS

- ▶ Precision milled tips for precise fit.
- ▶ Black oxide finish.

| Product # | Size | Overall Length (in) | Weight (lbs) |
|---------------|------|---------------------|--------------|
| J341/4 | 1, 2 | 4-3/4 | 0.07 |
| J343/8 | 3, 4 | 6-1/8 | 0.12 |



7 PIECE PROTO® HOLLOW SHAFT NUT DRIVER SET

Product #: **J9200H**

- ▶ Full hollow shaft design for maximum bolt clearance.
- ▶ One-piece shaft design for greater strength and durability.
- ▶ Ideal for electronics, assembly, and various industrial applications.
- ▶ Color coded handles for easy size identification.
- ▶ Weight (lbs): 4.22

| Contents | Size (in) | Length (in) (L1) | Overall Length (in) (L) | ASME Spec. |
|----------|------------------|------------------|-------------------------|--------------|
| J9206H | 3/16 | 2-3/4 | 6-11/16 | ASME B107.12 |
| J9208H | 1/4 | 2-3/4 | 6-11/16 | ASME B107.12 |
| J9210H | 5/16 | 2-3/4 | 6-11/16 | ASME B107.12 |
| J9211H | 11/32 | 2-3/4 | 6-11/16 | ASME B107.12 |
| J9212H | 3/8 | 2-3/4 | 6-11/16 | ASME B107.12 |
| J9214H | 7/16 | 2-3/4 | 6-11/16 | ASME B107.12 |
| J9216H | 1/2 | 2-3/4 | 6-11/16 | ASME B107.12 |
| J9200CBB | Blow-Molded Case | | | |





11 PIECE PROTO® NUT DRIVER SET

Product #: J9200DB

- › Precision formed, heat-treated hex openings.
- › Color coded handles for easy identification.
- › One-piece shaft design for greater strength and durability.
- › Weight (lbs): 4.22

| Contents | Size (in) | Length (in) (L1) | Overall Length (in) (L) | ASME Spec. |
|----------|------------------|------------------|-------------------------|--------------|
| J9206 | 3/16 | 2-3/4 | 6-11/16 | ASME B107.12 |
| J9207 | 7/32 | 2-3/4 | 6-11/16 | ASME B107.12 |
| J9208 | 1/4 | 2-3/4 | 6-11/16 | ASME B107.12 |
| J9209 | 9/32 | 2-3/4 | 6-11/16 | ASME B107.12 |
| J9210 | 5/16 | 2-3/4 | 6-11/16 | ASME B107.12 |
| J9211 | 11/32 | 2-3/4 | 6-11/16 | ASME B107.12 |
| J9212 | 3/8 | 2-3/4 | 6-11/16 | ASME B107.12 |
| J9214 | 7/16 | 2-3/4 | 7 | ASME B107.12 |
| J9216 | 1/2 | 2-3/4 | 7 | ASME B107.12 |
| J9218 | 9/16 | 2-3/4 | 7 | ASME B107.12 |
| J9220 | 5/8 | 2-3/4 | 7 | ASME B107.12 |
| J9200DPB | Blow-Molded Case | | | |



11 PIECE PROTO® METRIC NUT DRIVER SET

Product #: J9201MB

- › Precision formed, heat-treated hex openings.
- › One-piece shaft design for greater strength and durability.
- › Ideal for electronics, assembly, and various industrial applications.
- › Blue handle for easy metric identification.
- › Weight (lbs): 4.39

| Contents | Size (mm) | Length (in) (L1) | Overall Length (in) (L) | ASME Spec. |
|----------|------------------|------------------|-------------------------|--------------|
| J9204M | 4 | 2-7/8 | 7 | ASME B107.12 |
| J9205M | 5 | 2-7/8 | 7 | ASME B107.12 |
| J92055M | 5.5 | 2-7/8 | 7 | ASME B107.12 |
| J9206M | 6 | 2-7/8 | 7 | ASME B107.12 |
| J9207M | 7 | 2-7/8 | 7 | ASME B107.12 |
| J9208M | 8 | 2-7/8 | 7 | ASME B107.12 |
| J9209M | 9 | 2-7/8 | 7 | ASME B107.12 |
| J92010M | 10 | 2-7/8 | 7 | ASME B107.12 |
| J92011M | 11 | 2-7/8 | 7 | ASME B107.12 |
| J92013M | 13 | 2-7/8 | 7 | ASME B107.12 |
| J92014M | 14 | 2-7/8 | 7 | ASME B107.12 |
| J9200DPB | Blow-Molded Case | | | |





7 PIECE PROTO® NUT DRIVER SET

Product #: **J9200C**

- › Precision formed, heat-treated hex openings.
- › Color coded handles for easy identification.
- › One-piece shaft design for greater strength and durability.
- › Weight (lbs): 1.77

| Contents | Size (in) | Length (in) (L1) | Overall Length (in) (L) | ASME Spec. |
|----------|-----------|------------------|-------------------------|--------------|
| J9206 | 3/16 | 2-3/4 | 6-11/16 | ASME B107.12 |
| J9207 | 7/32 | 2-3/4 | 6-11/16 | ASME B107.12 |
| J9208 | 1/4 | 2-3/4 | 6-11/16 | ASME B107.12 |
| J9209 | 9/32 | 2-3/4 | 6-11/16 | ASME B107.12 |
| J9210 | 5/16 | 2-3/4 | 6-11/16 | ASME B107.12 |
| J9211 | 11/32 | 2-3/4 | 6-11/16 | ASME B107.12 |
| J9212 | 3/8 | 2-3/4 | 6-11/16 | ASME B107.12 |
| J25TR24C | Pouch | | | |



7 PIECE METRIC NUT DRIVER SET

Product #: **J9230M**

- › Precision formed, heat-treated hex openings.
- › One-piece shaft design for greater strength and durability.
- › Ideal for electronics, assembly, and various industrial applications.
- › Blue handle for easy metric identification.

| Contents | Size (mm) | Length (in) (L1) | Overall Length (in) (L) | ASME Spec. |
|----------|-----------|------------------|-------------------------|--------------|
| J92055M | 5.5 | 2-7/8 | 7 | ASME B107.12 |
| J9205M | 5 | 2-7/8 | 7 | ASME B107.12 |
| J9206M | 6 | 2-7/8 | 7 | ASME B107.12 |
| J9207M | 7 | 2-7/8 | 7 | ASME B107.12 |
| J9208M | 8 | 2-7/8 | 7 | ASME B107.12 |
| J9209M | 9 | 2-7/8 | 7 | ASME B107.12 |
| J9210M | 10 | 2-7/8 | 7 | ASME B107.12 |
| J2488 | Pouch | | | |





TRADITIONAL NUT DRIVERS

- › Full hollow shaft design for maximum bolt clearance (part numbers ending with "H").
- › One-piece shaft design for greater strength and durability.
- › Ideal for electronics, assembly, and various industrial applications.
- › Color coded handles for easy size identification.

| Product # | Size (in) | Size (mm) | Length (in) (L1) | Weight (lbs) |
|-----------|-----------|-----------|------------------|--------------|
| J9206H | 3/16 | – | 2-3/4 | 0.18 |
| J9208H | 1/4 | – | 2-3/4 | 0.18 |
| J9210H | 5/16 | – | 2-3/4 | 0.19 |
| J9211H | 11/32 | – | 2-3/4 | 0.22 |
| J9212H | 3/8 | – | 2-3/4 | 0.19 |
| J9214H | 7/16 | – | 2-3/4 | 0.27 |
| J9216H | 1/2 | – | 2-3/4 | 0.27 |
| J9206 | 3/16 | – | 2-3/4 | 0.20 |
| J9207 | 7/32 | – | 2-3/4 | 0.20 |
| J9208 | 1/4 | – | 2-3/4 | 0.19 |
| J9209 | 9/32 | – | 2-3/4 | 0.23 |
| J9210 | 5/16 | – | 2-3/4 | 0.23 |
| J9211 | 11/32 | – | 2-3/4 | 0.22 |
| J9212 | 3/8 | – | 2-3/4 | 0.23 |
| J9214 | 7/16 | – | 2-3/4 | 0.34 |
| J9216 | 1/2 | – | 2-3/4 | 0.34 |
| J9218 | 9/16 | – | 2-3/4 | 0.45 |
| J9220 | 5/8 | – | 2-3/4 | 0.50 |
| J9204M | – | 4 | 2-7/8 | 0.19 |
| J9205M | – | 5 | 2-7/8 | 0.19 |
| J92055M | – | 5.5 | 2-7/8 | 0.19 |
| J9206M | – | 6 | 2-7/8 | 0.19 |
| J9207M | – | 7 | 2-7/8 | 0.22 |
| J9208M | – | 8 | 2-7/8 | 0.22 |
| J9209M | – | 9 | 2-7/8 | 0.24 |
| J9210M | – | 10 | 2-7/8 | 0.29 |
| J9211M | – | 11 | 2-7/8 | 0.36 |
| J9212M | – | 12 | 2-7/8 | 0.36 |
| J9213M | – | 13 | 2-7/8 | 0.43 |
| J9214M | – | 14 | 2-7/8 | 0.50 |

 ASME B107.12

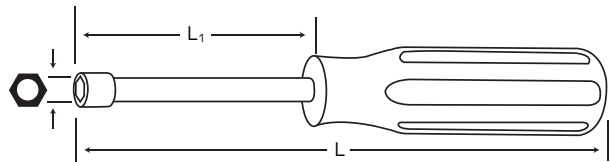

INSULATED NUT DRIVERS

- › Insulated to 1000V AC or 1500 DC.

| Product # | Size (in) | Length (in) | Weight (lbs) |
|-------------|------------|-------------|--------------|
| FM-71.1AVSE | 6x8 10x12 | 6 | 0.36 |
| FM-71.2AVSE | 6x9 11x13 | 6 | 0.54 |
| FM-71.3AVSE | 8x10 12x14 | 6 | 0.56 |



INSULATED T-HANDLES



- › Insulated to 1000V AC or 1500 DC.

| Product # | Size (mm) | Length (in) | Weight (lbs) |
|----------------|-----------|-------------|--------------|
| FM-94T.6AVSE | 6 | 5-3/4 | 0.33 |
| FM-94T.8AVSE | 8 | 5-3/4 | 0.36 |
| FM-94T.10AVSE | 10 | 5-3/4 | 0.41 |
| FM-94T.11AVSE | 11 | 5-3/4 | 0.47 |
| FM-94T.12AVSE | 12 | 5-3/4 | 0.47 |
| FM-94T.13AVSE | 13 | 5-3/4 | 0.50 |
| FM-94T.14AVSE | 14 | 5-3/4 | 0.50 |
| FM-94TL.10AVSE | 10 | 12-1/2 | 0.91 |
| FM-94TL.13AVSE | 13 | 12-1/2 | 1.15 |
| FM-94TL.16AVSE | 16 | 12-1/2 | 1.85 |
| FM-94TL.17AVSE | 17 | 12-1/2 | 1.92 |
| FM-94TL.19AVSE | 19 | 12-1/2 | 2.06 |



NUT SETTERS

- › Magnets feature enhanced holding power to help improve fastener retention, helping to increase productivity.



| Product # | Drive Size (in) | Socket Body Dia. (in) | Overall Length (in) | Weight (lbs) |
|-----------|-----------------|-----------------------|---------------------|--------------|
| J61652 | 1/4 Hex | 1/2 | 1-7/8 | 0.05 |
| J61654 | 1/4 Hex | 9/16 | 1-7/8 | 0.05 |
| J61650 | 1/4 Hex | 7/16 | 1-7/8 | 0.04 |
| J61656 | 1/4 Hex | 5/8 | 1-7/8 | 0.07 |
| J61690 | 1/4 Hex | 7/16 | 1-7/8 | 0.04 |
| J61692 | 1/4 Hex | 1/2 | 1-7/8 | 0.05 |
| J61694 | 1/4 Hex | 9/16 | 1-7/8 | 0.05 |
| J61620 | 1/4 Hex | 7/16 | 2-9/16 | 0.06 |
| J61628 | 1/4 Hex | 7/16 | 2-9/16 | 0.06 |
| J61622 | 1/4 Hex | 1/2 | 2-9/16 | 0.07 |
| J61630 | 1/4 Hex | 1/2 | 2-9/16 | 0.07 |
| J61624 | 1/4 Hex | 9/16 | 2-9/16 | 0.07 |
| J61632 | 1/4 Hex | 9/16 | 2-9/16 | 0.08 |
| J61626 | 1/4 Hex | 5/8 | 2-9/16 | 0.09 |



3 PIECE NUT SETTER SET - 1/4" HEX SHANK

Product #: J61909HS

- › TorquePlus™ features apply.
- › Magnets feature enhanced holding power to help improve fastener retention, helping to increase productivity.
- › Distinctive gold finish.
- › Weight (lbs): 0.21



| Contents | Description | Tips | Overall Length (in) | Weight (lbs) |
|----------|----------------------------|------------|---------------------|--------------|
| J61620HS | 1/4" Nut Setter, 1/4" Hex | Nut Setter | 2-9/16 | 0.06 |
| J61622HS | 5/16" Nut Setter, 1/4" Hex | Nut Setter | 1-9/16 | 0.07 |
| J61624HS | 3/8" Nut Setter, 1/4" Hex | Nut Setter | 1-9/16 | 0.07 |





18 PIECE STANDARD HEX KEY SET

Product #: J4986

- › Metal storage box included.
- › Weight (lbs): 3.36

| Contents | Size (in) | Long Arm Length (in) | Short Arm Length (in) | ASME Spec. |
|----------|-----------|----------------------|-----------------------|------------|
| J46101 | 0.028 | 1-1/4 | 1/8 | B18.3 |
| J46102 | 0.035 | 1-1/4 | 3/16 | B18.3 |
| J46103 | 0.050 | 1-11/16 | 1/2 | B18.3 |
| J46104 | 1/16 | 1-3/4 | 9/16 | B18.3 |
| J46105 | 5/64 | 1-7/8 | 5/8 | B18.3 |
| J46106 | 3/32 | 2 | 11/16 | B18.3 |
| J46107 | 7/64 | 2-1/8 | 23/32 | B18.3 |
| J46108 | 1/8 | 2-1/4 | 3/4 | B18.3 |
| J46109 | 9/64 | 2-3/8 | 13/16 | B18.3 |
| J46110 | 5/32 | 2-1/2 | 27/32 | B18.3 |
| J46112 | 3/16 | 2-3/4 | 15/16 | B18.3 |
| J46114 | 7/32 | 3 | 1 | B18.3 |
| J46116 | 1/4 | 3-1/4 | 1-1/8 | B18.3 |
| J46120 | 5/16 | 3-3/4 | 1-1/4 | B18.3 |
| J46124 | 3/8 | 4-1/4 | 1-3/8 | B18.3 |
| J46132 | 1/2 | 5-1/4 | 1-5/8 | B18.3 |
| J46136 | 9/16 | 5-3/4 | 1-3/4 | B18.3 |
| J46140 | 5/8 | 6-1/4 | 1-7/8 | B18.3 |

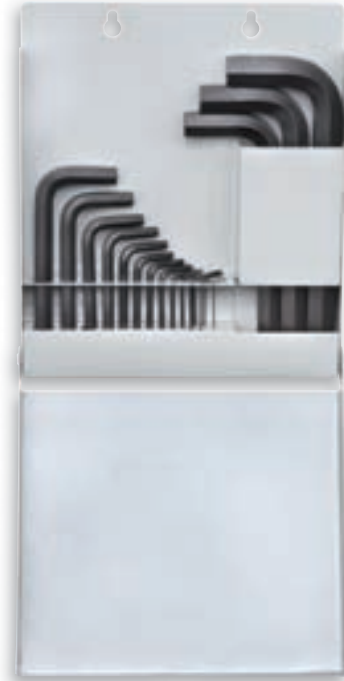

13 PIECE STANDARD HEX KEY SET

Product #: J4980

- › Molded plastic holder included.
- › Weight (lbs): 0.60

| Contents | Size (in) | Long Arm Length (in) | Short Arm Length (in) | ASME Spec. |
|----------|-----------|----------------------|-----------------------|------------|
| J46103 | 0.050 | 1-11/16 | 1/2 | B18.3 |
| J46104 | 1/16 | 1-3/4 | 9/16 | B18.3 |
| J46105 | 5/64 | 1-7/8 | 5/8 | B18.3 |
| J46106 | 3/32 | 2 | 11/16 | B18.3 |
| J46107 | 7/64 | 2-1/8 | 23/32 | B18.3 |
| J46108 | 1/8 | 2-1/4 | 3/4 | B18.3 |
| J46109 | 9/64 | 2-3/8 | 13/16 | B18.3 |
| J46110 | 5/32 | 2-1/2 | 27/32 | B18.3 |
| J46112 | 3/16 | 2-3/4 | 15/16 | B18.3 |
| J46114 | 7/32 | 3 | 1 | B18.3 |
| J46116 | 1/4 | 3-1/4 | 1-1/8 | B18.3 |
| J46120 | 5/16 | 3-3/4 | 1-1/4 | B18.3 |
| J46124 | 3/8 | 4-1/4 | 1-3/8 | B18.3 |



11 PIECE STANDARD HEX KEY SET

Product #: **J4981**

- › Molded plastic holder included.
- › Weight (lbs): 0.24

| Contents | Size (in) | Long Arm Length (in) | Short Arm Length (in) | ASME Spec. |
|----------|-----------|----------------------|-----------------------|------------|
| J46103 | 0.050 | 1-11/16 | 1/2 | B18.3 |
| J46104 | 1/16 | 1-3/4 | 9/16 | B18.3 |
| J46106 | 3/32 | 2 | 11/16 | B18.3 |
| J46105 | 5/64 | 1-7/8 | 5/8 | B18.3 |
| J46107 | 7/64 | 2-1/8 | 23/32 | B18.3 |
| J46108 | 1/8 | 2-1/4 | 3/4 | B18.3 |
| J46109 | 9/64 | 2-3/8 | 13/16 | B18.3 |
| J46110 | 5/32 | 2-1/2 | 27/32 | B18.3 |
| J46112 | 3/16 | 2-3/4 | 15/16 | B18.3 |
| J46114 | 7/32 | 3 | 1 | B18.3 |
| J46116 | 1/4 | 3-1/4 | 1-1/8 | B18.3 |

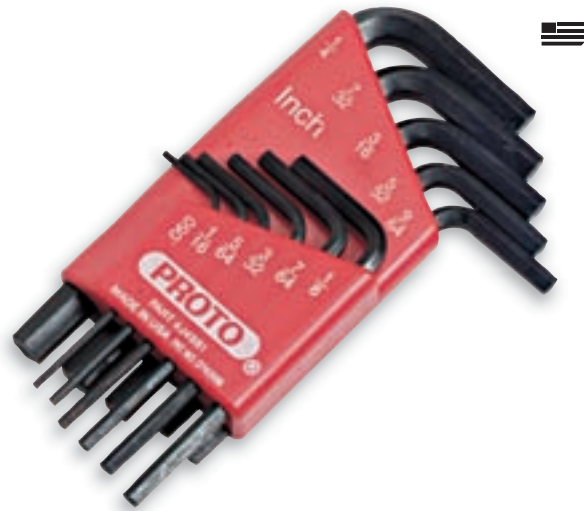

7 PIECE STANDARD HEX KEY SET

Product #: **J4982**

- › Molded plastic holder included.
- › Weight (lbs): 1.20

| Contents | Size (in) | Long Arm Length (in) | Short Arm Length (in) | ASME Spec. |
|----------|-----------|----------------------|-----------------------|------------|
| J46105 | 5/64 | 1-7/8 | 5/8 | B18.3 |
| J46106 | 3/32 | 2 | 11/16 | B18.3 |
| J46108 | 1/8 | 2-1/4 | 3/4 | B18.3 |
| J46110 | 5/32 | 2-1/2 | 27/32 | B18.3 |
| J46112 | 3/16 | 2-3/4 | 15/16 | B18.3 |
| J46114 | 7/32 | 3 | 1 | B18.3 |
| J46116 | 1/4 | 3-1/4 | 1-1/8 | B18.3 |



15 PIECE STANDARD HEX KEY SET - METRIC

Product #: **J4988M**

- › Metal storage box included.
- › Weight (lbs): 3.4

| Contents | Size (mm) | Long Arm Length (in) | Short Arm Length (in) | ASME Spec. |
|----------|-----------|----------------------|-----------------------|------------|
| J46300 | 0.07 | 1-7/32 | 15/64 | B18.3.2M |
| J46302 | 0.09 | 1-7/32 | 23/64 | B18.3.2M |
| J46304 | 1.3 | 1-39/64 | 33/64 | B18.3.2M |
| J46306 | 1.5 | 1-47/64 | 33/64 | B18.3.2M |
| J46308 | 2 | 1-59/64 | 5/8 | B18.3.2M |
| J46310 | 2.5 | 2-11/64 | 45/64 | B18.3.2M |
| J46312 | 3 | 2-7/16 | 3/4 | B18.3.2M |
| J46314 | 4 | 2-43/64 | 15/16 | B18.3.2M |
| J46316 | 5 | 3-5/64 | 1-1/16 | B18.3.2M |
| J46318 | 6 | 3-15/32 | 1-7/32 | B18.3.2M |
| J46320 | 8 | 3-55/64 | 1-3/8 | B18.3.2M |
| J46322 | 10 | 4-19/64 | 1-17/32 | B18.3.2M |
| J46324 | 12 | 4-51/64 | 1-47/64 | B18.3.2M |
| J46326 | 14 | 5-23/64 | 2-11/64 | B18.3.2M |
| J46328 | 17 | 6-9/64 | 2-13/32 | B18.3.2M |



9 PIECE STANDARD HEX KEY SET - METRIC

METRIC

Product #: J4984

- › Molded plastic holder included.
- › Overall length for hex keys ranges from 33/64" to 1-17/32".
- › Hex size ranges from 1.5 mm to 10 mm.
- › Weight (lbs): 0.54

| Contents | Size (mm) | Long Arm Length (in) | Short Arm Length (in) | ASME Spec. |
|----------|-----------|----------------------|-----------------------|------------|
| J46306 | 1.5 | 1-47/64 | 33/64 | B18.3.2M |
| J46308 | 2 | 1-59/64 | 5/8 | B18.3.2M |
| J46310 | 2.5 | 2-11/64 | 45/64 | B18.3.2M |
| J46312 | 3 | 2-7/16 | 3/4 | B18.3.2M |
| J46314 | 4 | 2-43/64 | 15/16 | B18.3.2M |
| J46316 | 5 | 3-5/64 | 1-1/16 | B18.3.2M |
| J46318 | 6 | 3-15/32 | 1-7/32 | B18.3.2M |
| J46320 | 8 | 3-55/64 | 1-3/8 | B18.3.2M |
| J46322 | 10 | 4-19/64 | 1-17/32 | B18.3.2M |



7 PIECE STANDARD HEX KEY SET - METRIC

METRIC

Product #: J4985

- › Molded plastic holder.
- › Overall length for hex keys ranges from 44 mm to 88 mm.
- › Hex size ranges from 1.5 mm to 6 mm.
- › Weight (lbs): 0.16

| Contents | Size (mm) | Long Arm Length (in) | Short Arm Length (in) | ASME Spec. |
|----------|-----------|----------------------|-----------------------|------------|
| J46306 | 1.5 | 1-47/64 | 33/64 | B18.3.2M |
| J46308 | 2 | 1-59/64 | 5/8 | B18.3.2M |
| J46310 | 2.5 | 2-11/64 | 45/64 | B18.3.2M |
| J46312 | 3 | 2-7/16 | 3/4 | B18.3.2M |
| J46314 | 4 | 2-43/64 | 15/16 | B18.3.2M |
| J46316 | 5 | 3-5/64 | 1-1/16 | B18.3.2M |
| J46318 | 6 | 3-15/32 | 1-7/32 | B18.3.2M |



13 PIECE ROUND HEAD HEX KEY SET

Product #: J4995

- › Screws can be tightened or loosened at angles up to 25°.
- › Weight (lbs): 0.82

| Size (in) | Length (in) |
|-----------|-------------|
| .050 | 2-5/16 |
| 1/6 | 3-1/6 |
| 5/64 | 3-1/4 |
| 3/32 | 3-1/2 |
| 7/64 | 3-11/16 |
| 1/8 | 3-7/8 |
| 9/64 | 4-1/8 |
| 5/32 | 4-5/16 |
| 3/16 | 4-11/16 |
| 7/32 | 5-1/8 |
| 1/4 | 5-1/2 |
| 5/16 | 6-1/4 |
| 3/8 | 7-1/16 |

Molded Plastic Holder



9 PIECE ROUND HEAD HEX KEY SET - METRIC

METRIC

Product #: J4996

- › Ball end can tighten or loosen screws at angles up to 25°.
- › Weight (lbs): 1.70

| Size (mm) | Length (in) |
|-----------|-------------|
| 1.5 | 3-5/64 |
| 2 | 3-5/16 |
| 2.5 | 3-5/8 |
| 3 | 4-1/64 |
| 4 | 4-31/64 |
| 5 | 5-1/8 |
| 6 | 6-9/64 |
| 8 | 7-1/64 |
| 10 | 7-3/4 |

Molded Plastic Holder



10 PIECE TORX® KEY SET

Product #: J4961

- › Weight (lbs): 0.76

| Torx® Size | Length (in) |
|------------|-------------|
| T10 | 2-3/8 |
| T15 | 2-1/2 |
| T20 | 2-11/16 |
| T25 | 2-1/8 |
| T27 | 3 |
| T30 | 3-1/4 |
| T40 | 3-15/16 |
| T45 | 4-1/16 |
| T50 | 4-9/16 |
| T55 | 5-3/16 |

Plastic Pouch



14 PIECE LONG HEX KEY SET

Product #: J4987

- › Metal storage box included.
- › Weight (lbs): 2.28

| Contents | Size (in) | Long Arm Length (in) | Short Arm Length (in) | ASME Spec. |
|----------|-----------|----------------------|-----------------------|------------|
| J46203 | 0.050 | 2-7/8 | 1/2 | B18.3 |
| J46204 | 1/16 | 3 | 9/16 | B18.3 |
| J46205 | 5/64 | 3-3/16 | 5/8 | B18.3 |
| J46206 | 3/32 | 3-3/8 | 11/16 | B18.3 |
| J46207 | 7/64 | 3-9/16 | 23/32 | B18.3 |
| J46208 | 1/8 | 3-3/4 | 3/4 | B18.3 |
| J46209 | 9/64 | 3-15/16 | 13/16 | B18.3 |
| J46210 | 5/32 | 4-1/8 | 27/32 | B18.3 |
| J46212 | 3/16 | 4-1/2 | 15/16 | B18.3 |
| J46214 | 7/32 | 4-7/8 | 1 | B18.3 |
| J46216 | 1/4 | 5-1/4 | 1-1/8 | B18.3 |
| J46220 | 5/16 | 6 | 1-1/4 | B18.3 |
| J46224 | 3/8 | 6-3/4 | 1-3/8 | B18.3 |
| J46232 | 1/2 | 8-1/4 | 1-5/8 | B18.3 |



13 PIECE LONG HEX KEY SET

Product #: J4983

| Contents | Size (in) | Long Arm Length (in) | Short Arm Length (in) | ASME Spec. |
|----------|-----------|----------------------|-----------------------|------------|
| J46203 | 0.050 | 2-7/8 | 1/2 | B18.3 |
| J46204 | 1/16 | 3 | 9/16 | B18.3 |
| J46205 | 5/64 | 3-3/16 | 5/8 | B18.3 |
| J46206 | 3/32 | 3-3/8 | 11/16 | B18.3 |
| J46207 | 7/64 | 3-9/16 | 23/32 | B18.3 |
| J46208 | 1/8 | 3-3/4 | 3/4 | B18.3 |
| J46209 | 9/64 | 3-15/16 | 13/16 | B18.3 |
| J46210 | 5/32 | 4-1/8 | 27/32 | B18.3 |
| J46212 | 3/16 | 4-1/2 | 15/16 | B18.3 |
| J46214 | 7/32 | 4-7/8 | 1 | B18.3 |
| J46216 | 1/4 | 5-1/4 | 1-1/8 | B18.3 |
| J46220 | 5/16 | 6 | 1-1/4 | B18.3 |
| J46224 | 3/8 | 6-3/4 | 1-3/8 | B18.3 |

- › Molded plastic holder included.
- › Weight (lbs): 0.84



STANDARD HEX KEYS

- › Heat-treated for durability.
- › Rust resistant black oxide finish.

| Product # | Size (in) | Size (mm) | Long Arm Length (in) | Short Arm Length (in) | Weight (lbs) |
|-----------|-----------|-----------|----------------------|-----------------------|--------------|
| J46101 | 0.028 | - | 1-1/4 | 1/8 | 0.01 |
| J46102 | 0.035 | - | 1-1/4 | 3/16 | 0.01 |
| J46103 | 0.050 | - | 1-11/16 | 1/2 | 0.01 |
| J46104 | 1/16 | - | 1-3/4 | 9/16 | 0.01 |
| J46105 | 5/64 | - | 1-7/8 | 5/8 | 0.01 |
| J46106 | 3/32 | - | 2 | 11/16 | 0.01 |
| J46107 | 7/64 | - | 2-1/8 | 23/32 | 0.01 |
| J46108 | 1/8 | - | 2-1/4 | 3/4 | 0.01 |
| J46109 | 9/64 | - | 2-3/8 | 13/16 | 0.02 |
| J46110 | 5/32 | - | 2-1/2 | 27/32 | 0.02 |
| J46112 | 3/16 | - | 2-3/4 | 15/16 | 0.03 |
| J46114 | 7/32 | - | 3 | 1 | 0.05 |
| J46116 | 1/4 | - | 3-1/4 | 1-1/8 | 0.07 |
| J46120 | 5/16 | - | 3-3/4 | 1-1/4 | 0.10 |
| J46124 | 3/8 | - | 4-1/4 | 1-3/8 | 0.19 |
| J46128 | 7/16 | - | 4-3/4 | 1-1/2 | 0.31 |
| J46132 | 1/2 | - | 5-1/4 | 1-5/8 | 0.31 |
| J46136 | 9/16 | - | 5-3/4 | 1-3/4 | 0.31 |
| J46140 | 5/8 | - | 6-1/4 | 1-7/8 | 0.58 |
| J46300 | - | 0.07 | 1-7/32 | 15/64 | 0.01 |
| J46302 | - | 0.09 | 1-7/32 | 23/64 | 0.01 |
| J46304 | - | 1.3 | 1-39/64 | 33/64 | 0.01 |
| J46306 | - | 1.5 | 1-47/64 | 33/64 | 0.01 |
| J46308 | - | 2 | 1-59/64 | 5/8 | 0.01 |
| J46310 | - | 2.5 | 2-11/64 | 45/64 | 0.01 |
| J46312 | - | 3 | 2-7/16 | 3/4 | 0.01 |
| J46314 | - | 4 | 2-43/64 | 15/16 | 0.01 |
| J46316 | - | 5 | 3-5/64 | 1-1/16 | 0.04 |
| J46318 | - | 6 | 3-15/32 | 1-7/32 | 0.07 |
| J46320 | - | 8 | 3-55/64 | 1-3/8 | 0.13 |
| J46322 | - | 10 | 4-19/64 | 1-17/32 | 0.23 |
| J46324 | - | 12 | 4-51/64 | 1-47/64 | 0.36 |
| J46326 | - | 14 | 5-23/64 | 2-11/64 | 0.57 |
| J46328 | - | 17 | 6-9/64 | 2-13/32 | 0.95 |





LONG HEX KEYS

- › Heat-treated for durability.
- › Rust resistant black oxide finish.



| Product # | Size (in) | Long Arm Length (in) | Short Arm Length (in) | Weight (lbs) |
|-----------|-----------|----------------------|-----------------------|--------------|
| J46203 | .050 | 2-7/8 | 1/2 | 0.01 |
| J46204 | 1/16 | 3 | 9/16 | 0.01 |
| J46205 | 5/64 | 3-3/16 | 5/8 | 0.01 |
| J46206 | 3/32 | 3-3/8 | 11/16 | 0.01 |
| J46207 | 7/64 | 3-9/16 | 23/32 | 0.01 |
| J46208 | 1/8 | 3-3/4 | 3/4 | 0.02 |
| J46209 | 9/64 | 3-15/16 | 13/16 | 0.03 |
| J46210 | 5/32 | 4-1/8 | 27/32 | 0.03 |
| J46212 | 3/16 | 4-1/2 | 15/16 | 0.05 |
| J46214 | 7/32 | 4-7/8 | 1 | 0.07 |
| J46216 | 1/4 | 5-1/4 | 1-1/8 | 0.10 |
| J46220 | 5/16 | 6 | 1-1/4 | 0.17 |
| J46224 | 3/8 | 6-3/4 | 1-3/8 | 0.28 |
| J46228 | 7/16 | 7-1/2 | 1-1/2 | 0.45 |
| J46232 | 1/2 | 8-1/4 | 1-5/8 | 0.61 |



B18.3

FACOM® INSULATED HEX KEYS

- › Hardened alloy-steel exceeds specified strengths.
- › 2-color warning insulation.
- › Insulated to 1000V AC or 1500 DC.



| Product # | Size (mm) | Long Arm Length (in) | Short Arm Length (in) | Weight (lbs) |
|--------------|-----------|----------------------|-----------------------|--------------|
| FM-83.3AVSE | 3 | 4-59/64 | 3-11/32 | 0.04 |
| FM-83.4AVSE | 4 | 4-59/64 | 3-11/32 | 0.07 |
| FM-83.5AVSE | 5 | 4-59/64 | 3-11/32 | 0.11 |
| FM-83.6AVSE | 6 | 4-59/64 | 3-11/32 | 0.15 |
| FM-83.8AVSE | 8 | 4-59/64 | 3-11/32 | 0.24 |
| FM-83.10AVSE | 10 | 4-59/64 | 3-11/32 | 0.33 |
| FM-83.12AVSE | 12 | 4-59/64 | 3-11/32 | 0.46 |



11 PIECE T-HANDLE HEX KEY SET

Product #: J4968

› Weight (lbs): 3.98

| Contents | Size (in) | Handle Length (in) | Length (in) | Weight (lbs) |
|----------|-----------|--------------------|-------------|--------------|
| J46405 | 5/64 | 3 | 6 | 0.11 |
| J46406 | 3/32 | 3 | 6 | 0.11 |
| J46407 | 7/64 | 3 | 6 | 0.11 |
| J46408 | 1/8 | 3 | 6 | 0.14 |
| J46409 | 9/64 | 3 | 6 | 0.14 |
| J46410 | 5/32 | 3 | 6 | 0.32 |
| J46412 | 3/16 | 4 | 6 | 0.32 |
| J46414 | 7/32 | 4 | 6 | 0.63 |
| J46416 | 1/4 | 4 | 6 | 0.82 |
| J46420 | 5/16 | 6 | 6 | 0.89 |
| J46424 | 3/8 | 6 | 6 | 0.90 |

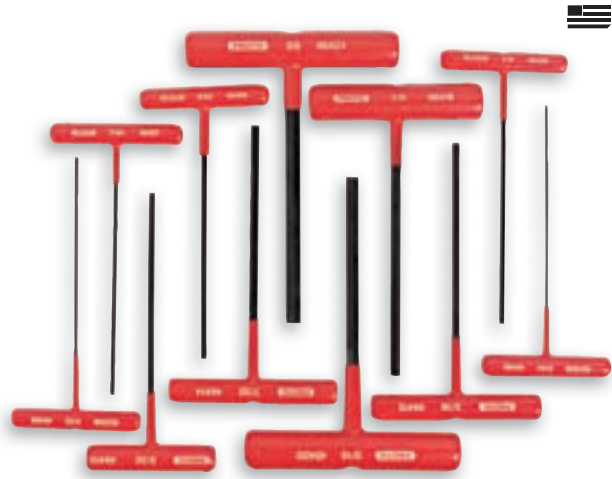

T-HANDLE HEX KEYS

| Product # | Size (in) | Handle Length (in) | Length (in) | Weight (lbs) |
|---------------|-----------|--------------------|-------------|--------------|
| J46405 | 5/64 | 3 | 6 | 0.11 |
| J46406 | 3/32 | 3 | 6 | 0.11 |
| J46407 | 7/64 | 3 | 6 | 0.11 |
| J46408 | 1/8 | 3 | 6 | 0.14 |
| J46409 | 9/64 | 3 | 6 | 0.14 |
| J46410 | 5/32 | 3 | 6 | 0.32 |
| J46412 | 3/16 | 4 | 6 | 0.32 |
| J46414 | 7/32 | 4 | 6 | 0.63 |
| J46416 | 1/4 | 4 | 6 | 0.82 |
| J46420 | 5/16 | 6 | 6 | 0.89 |
| J46424 | 3/8 | 6 | 6 | 0.90 |



6 PIECE METRIC T-HANDLE HEX KEY SET

Product #: J4969

› Weight (lbs): 1.00

| Contents | Size (mm) | Handle Length (in) | Length (in) | Weight (lbs) |
|----------|-----------|--------------------|-------------|--------------|
| J46508 | 2 | 3 | 6 | 0.11 |
| J46510 | 2.5 | 3 | 6 | 0.13 |
| J46512 | 3 | 3 | 6 | 0.13 |
| J46514 | 4 | 3 | 6 | 0.14 |
| J46516 | 5 | 4 | 6 | 0.32 |
| J46518 | 6 | 4 | 6 | 0.62 |



T-HANDLE HEX KEYS - METRIC

| Product # | Size (mm) | Length (in) | Weight (lbs) |
|---------------|-----------|-------------|--------------|
| J46508 | 2 | 6 | 0.11 |
| J46510 | 2.5 | 6 | 0.13 |
| J46512 | 3 | 6 | 0.13 |
| J46514 | 4 | 6 | 0.14 |
| J46516 | 5 | 6 | 0.32 |
| J46518 | 6 | 6 | 0.62 |





9 PIECE FOLDING HEX KEY SET

Product #: **J4993CG**

| Hex Size (in) | Set Screws | Fits Cap Screws 1960 Series | Cap Screws 1936 Series |
|---------------|-------------|-----------------------------|------------------------|
| 5/64 | #8 | #2, #3 | #3, #4 |
| 3/32 | #10, #12 | #4, #5 | #5, #6 |
| 7/64 | – | #6 | – |
| 1/8 | 1/4" | – | #8 |
| 9/64 | – | #8 | – |
| 5/32 | 5/16" | #10 | #10 |
| 3/16 | 3/8" | 1/4" | 1/4" |
| 7/32 | 7/16" | – | 5/16" |
| 1/4 | 1/2", 9/16" | 5/16" | – |

ASME B18.3

- › Case is 4-1/4" long.
- › Black oxide bits are 1-7/16" to 2-3/4" long.
- › Cushioned palm grip for comfort.
- › Weight (lbs): 0.47



9 PIECE FOLDING HEX KEY SET

Product #: **J4978**

| Hex Size (in) | Set Screws | Fits Cap Screws 1960 Series | Cap Screws 1936 Series |
|---------------|------------|-----------------------------|------------------------|
| .050 | #3, #4 | #0 | #0, #1 |
| 1/16 | #5, #6 | #1 | #2 |
| 5/64 | #8 | #2, #3 | #3, #4 |
| 3/32 | #10, #12 | #4, #5 | #5, #6 |
| 7/64 | – | #6 | – |
| 1/8 | 1/4 | – | #8 |
| 9/64 | – | #8 | – |
| 5/32 | 5/16 | #10 | #10 |
| 3/16 | 3/8 | 1/4 | 1/4 |

- › Chrome plated steel case is 3-5/8" long.
- › Black oxide bits are 1-1/2" to 2" long.
- › Weight (lbs): 0.27



9 PIECE FOLDING HEX KEY SET

Product #: **J4993**

| Hex Size (in) | Set Screws | Fits Cap Screws 1960 Series | Cap Screws 1936 Series |
|---------------|------------|-----------------------------|------------------------|
| 5/64 | #8 | #2, #3 | #3, #4 |
| 3/32 | #10, #12 | #4, #5 | #5, #6 |
| 7/64 | – | #6 | – |
| 1/8 | 1/4 | – | #8 |
| 9/64 | – | #8 | – |
| 5/32 | 5/16 | #10 | #10 |
| 3/16 | 3/8 | 1/4 | 1/4 |
| 7/32 | 7/16 | – | 5/16 |
| 1/4 | 1/2, 9/16 | 5/16 | – |

- › Chrome plated steel case is 4-1/2" long.
- › Black oxide bits are 1-7/16" to 2-3/4" long.
- › Weight (lbs): 0.47





8 PIECE FOLDING HEX KEY SET

Product #: J4992CG

| Hex Size (in) | Set Screws | Fits Cap Screws 1960 Series | Cap Screws 1936 Series |
|---------------|------------|-----------------------------|------------------------|
| .050 | #3, #4 | #0 | #0, #1 |
| 1/16 | #5, #6 | #1 | #2 |
| 5/64 | #8 | #2, #3 | #3, #4 |
| 3/32 | #10, #12 | #4, #5 | #5, #6 |
| 7/64 | – | #6 | – |
| 1/8 | 1/4 | – | #8 |
| 9/64 | – | #8 | – |
| 5/32 | 5/16 | #10 | #10 |

 ASME B18.3

- › Case is 3" long.
- › Black oxide bits are 1-1/4" to 1-15/16" long.
- › Cushioned palm grip for comfort.
- › Weight (lbs): 0.18



8 PIECE FOLDING HEX KEY SET

Product #: J4992

| Hex Size (in) | Set Screws | Fits Cap Screws 1960 Series | Cap Screws 1936 Series |
|---------------|------------|-----------------------------|------------------------|
| .050 | #3, #4 | #0 | #0, #1 |
| 1/16 | #5, #6 | #1 | #2 |
| 5/64 | #8 | #2, #3 | #3, #4 |
| 3/32 | #10, #12 | #4, #5 | #5, #6 |
| 7/64 | – | #6 | – |
| 1/8 | 1/4 | – | #8 |
| 9/64 | – | #8 | – |
| 5/32 | 5/16 | #10 | #10 |

 ASME B18.3

- › Chrome plated steel case is 3" long.
- › Black oxide bits are 1-1/4" to 1-5/16" long.
- › Weight (lbs): 0.18



6 PIECE FOLDING CUSHION GRIP HEX KEY SET

Product #: J4996CG

- › Case is 5-1/2" long.
- › Cushioned palm grip for comfort.
- › Weight (lbs): 0.24

Hex Size (in)

| |
|------|
| 5/32 |
| 3/16 |
| 7/32 |
| 1/4 |
| 5/16 |
| 3/8 |



8 PIECE LONG FOLDING HEX KEY SET

Product #: **J4991**

| Hex Size (in) | Set Screws | Fits Cap Screws 1960 Series | Cap Screws 1936 Series |
|---------------|------------|-----------------------------|------------------------|
| 3/32 | #10, #12 | #4, #5 | #5, #6 |
| 7/64 | - | #6 | - |
| 1/8 | 1/4 | - | #8 |
| 9/64 | - | #8 | - |
| 5/32 | 5/16 | #10 | #10 |
| 3/16 | 3/8 | 1/4 | 1/4 |
| 7/32 | 7/16 | - | 5/16 |
| 1/4 | 1/2, 9/16 | 5/16 | - |

- ▶ Chrome plated steel case is 5-1/4" long.
- ▶ Black oxide bits are 4" long.
- ▶ Weight (lbs): 0.61



5 PIECE LONG FOLDING HEX KEY SET

Product #: **J4994**

| Hex Size (in) | Set Screws | Fits Cap Screws 1960 Series | Cap Screws 1936 Series |
|---------------|------------|-----------------------------|------------------------|
| 3/16 | 3/8 | 1/4 | 1/4 |
| 7/32 | 7/16 | - | 5/16 |
| 1/4 | 1/2, 9/16 | 5/16 | - |
| 5/16 | 5/8 | 3/8 | 3/8, 7/16 |
| 3/8 | 3/4 | 7/16, 1/2 | 1/2, 9/16 |

- ▶ Chrome plated steel case is 5-1/4" long.
- ▶ Black oxide bits are 2-7/16" to 3-1/4" long.
- ▶ Weight (lbs): 0.83



7 PIECE METRIC LONG FOLDING HEX KEY SET

Product #: **J4974CG**

| Hex Size (mm) | Length (in) |
|---------------|-------------|
| 1.5 | 3 |
| 2 | 3 |
| 2.5 | 3 |
| 3 | 3 |
| 4 | 3 |
| 5 | 3 |
| 6 | 3 |

ASME B18.3.2M

- ▶ Case is 3-1/2" long.
- ▶ Cushioned palm grip for comfort.
- ▶ Weight (lbs): 0.31



6 PIECE METRIC LONG FOLDING HEX KEY SET

Product #: **J4973CG**

| Hex Size (mm) | Length (in) |
|---------------|-------------|
| 3 | 3 |
| 4 | 3 |
| 5 | 3 |
| 6 | 3 |
| 8 | 3 |
| 10 | 3 |

ASME B18.3.2M

- ▶ Case is 6-1/2" long.
- ▶ Black oxide bits are 3" long.
- ▶ Cushioned palm grip for comfort.
- ▶ Weight (lbs): 0.84



7 PIECE METRIC FOLDING HEX KEY SET

METRIC

Product #: J4974

- › Chrome plated steel case is 3-1/2" long.
- › Black oxide bits are 3" long.
- › Weight (lbs): 0.31

| Hex Size (mm) | Length (in) |
|---------------|-------------|
| 1.5 | 3 |
| 2 | 3 |
| 2.5 | 3 |
| 3 | 3 |
| 4 | 3 |
| 5 | 3 |
| 6 | 3 |



6 PIECE METRIC LONG FOLDING HEX KEY SET

METRIC

Product #: J4973

- › Chrome plated steel case is 6-1/2" long.
- › Black oxide bits are 5" long.
- › Weight (lbs): 0.84

| Hex Size (mm) | Length (in) |
|---------------|-------------|
| 3 | 5 |
| 4 | 5 |
| 5 | 5 |
| 6 | 5 |
| 8 | 5 |
| 10 | 5 |



8 PIECE TORX® FOLDING HEX KEY SET

Product #: J4979TXCG

- › Cushioned palm grip for comfort.
- › Weight (lbs): 0.45

| Torx® Size | Length (in) |
|------------|-------------|
| T9 - T40 | 3 |



8 PIECE TORX® FOLDING HEX KEY SET

Product #: J4979TX

- › Weight (lbs): 0.45

| Torx® Size | Length (in) |
|------------|-------------|
| T9 | 2-1/4 |
| T10 | 2-3/8 |
| T15 | 2-9/16 |
| T20 | 2-5/8 |
| T25 | 2-3/4 |
| T27 | 2-7/8 |
| T30 | 3 |
| T40 | 3-1/8 |



**BASEBALL HAS THE UTILITY INFIELDER.
INDUSTRY HAS THE PLIERS.**

Regardless of the industry, pliers, clamps, cutters and snips get reached for often. Proto®'s line is broad, featuring a wide range of general and specific-use tools. It's tough, too, forged from high quality alloy steel that's heat-treated. Most of our pliers are fitted with cushioned, slip-resistant handles.

And we build in features to reduce effort on your part. For example, our Electrostatic Discharge (ESD) pliers are a unique, dual-leaf spring design that automatically opens the jaws when you relax your grip.

Our pliers fit the task, cover the gamut and make work easier. That's utility.



PLIERS, CLAMPING AND CUTTING



Curved Jaw Locking Pliers

PROTO



PROTO® LOCKING PLIERS

Designed by engineers who look at each problem with fresh eyes, no matter how simple, each Proto® tool brings quality, durability and accuracy to the job site.

High corrosion resistant finish with welding spatter resistance.

Large diameter rivets to provide secure joints adding to the durability and robustness of the tools.

Locking mechanism helps leave both hands free when clamping, helping to eliminate squeezing action and general hand fatigue when manipulating.



Tip of release lever projects at end of handle for a quick, no-pinch, powerful release especially when tools are firmly locked.

Spring-loaded release lever is out of the way when handling.

Drop forged jaws and rugged tooth profile for durability and toughness.

Holes in mobile jaw are drilled, not press punched to ensure cylindrical shape and maximum bearing with rivets.



SAFETY WIRE PLIERS

Safety wire is a type of positive locking device that prevents fasteners from loosening due to vibration and other forces. The presence of safety wiring also serves to indicate that the fasteners have been properly tightened.

Safety wire is available in a variety of gauges and materials, depending on the application. In aircraft and racing applications, stainless steel wire is used, most commonly in .032" diameter. Typically, the wire is threaded through a hole drilled into a fastener or part, then twisted and anchored to a second fastener or part, then twisted again.



SLIP-JOINT PLIERS

Adjustable for a variety of general uses.



TONGUE AND GROOVE



COMBINATION



THIN NOSE



HOSE CLAMP

FIXED-JOINT PLIERS

Flush joint design for specialty jaws



NEEDLE-NOSE



DUCKBILL



DIAGONAL CUTTING



LINEMAN'S

INSULATED PLIERS

Insulated to 1000 volts AC and 1500 volts DC



MULTIGRIP



FLAT NOSE



END CUTTER



BENT NOSE

TONGUE AND GROOVE POWER-TRACK® II PLIERS

- › Precision milled undercut groove joint provides interlocking feature for powerful non-slip performance.
- › Special fastener ensures permanent assembly, yet allows for easy adjustment.
- › Angled teeth provide superior gripping power over standard right angled teeth.
- › Plastisol grips for added comfort.
- › Natural finish.



| Product # | Overall Length (in) (L) | Max. Opening (in) | Jaw Length (in) (A) | Jaw Width (in) (B) | Jaw Thickness (in) (C) | Weight (lbs) |
|---------------|-------------------------|-------------------|---------------------|--------------------|------------------------|--------------|
| J261SG | 4-5/8 | 15/32 | 7/8 | 13/16 | 3/16 | 0.15 |
| J262SG | 7-1/16 | 1-1/8 | 1-3/8 | 1-3/4 | 5/16 | 0.48 |
| J260SG | 10-3/16 | 2-1/8 | 1-15/16 | 2-3/4 | 13/32 | 1.00 |
| J264SG | 12 | 2-5/8 | 2-1/4 | 2-3/4 | 3/8 | 1.81 |
| J265SG | 16-7/8 | 4-1/16 | 3-3/8 | 4-1/8 | 17/32 | 3.50 |

ASME B107.500

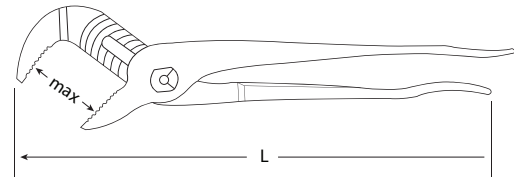
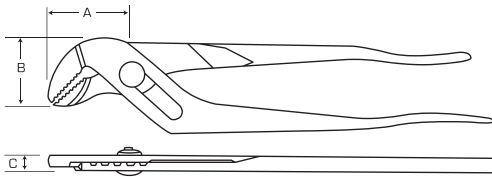

COMBINATION SLIP-JOINT PLIERS

- › Has two jaw positions and shear type wire cutter.



| Product # | Overall Length (in) (L) | Jaw Length (in) (A) | Jaw Width (in) (B) | Jaw Thickness (in) (C) | Weight (lbs) |
|-------------|-------------------------|---------------------|--------------------|------------------------|--------------|
| J275 | 5-3/4 | 1-5/16 | 7/8 | 9/32 | 0.24 |
| J276 | 6-1/2 | 1-3/4 | 1-3/16 | 3/8 | 0.52 |
| J278 | 8 | 1-3/4 | 1-13/64 | 3/8 | 0.67 |
| J280 | 9-1/2 | 2-3/8 | 1-7/64 | 15/32 | 1.00 |

ASME B107.500

COMBINATION SLIP-JOINT PLIERS WITH GRIP

- › Has two jaw positions and shear type wire cutter.
- › Plastisol grips for added comfort.



| Product # | Overall Length (in) (L) | Jaw Length (in) (A) | Jaw Width (in) (B) | Jaw Thickness (in) (C) | Weight (lbs) |
|--------------|-------------------------|---------------------|--------------------|------------------------|--------------|
| J275G | 5-13/16 | 1-5/16 | 7/8 | 9/32 | 0.24 |
| J276G | 6-9/16 | 1-3/4 | 1-3/16 | 3/8 | 0.52 |
| J278G | 8-1/16 | 1-3/4 | 1-13/64 | 3/8 | 0.67 |
| J280G | 9-9/16 | 2-3/8 | 1-7/16 | 15/32 | 1.00 |

ASME B107.500



SMALL ANGLE NOSE PLIERS

- › Nose angled for easy access.
- › Angled teeth provide superior gripping power over standard right angled teeth.
- › Plastisol grips for added comfort.

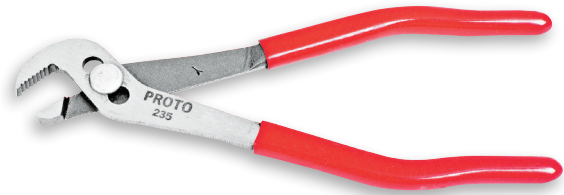

| Product # | Overall Length (in) (L) | Jaw Length (in) (A) | Jaw Width (in) (B) | Jaw Thickness (in) (C) | Weight (lbs) |
|-------------|-------------------------|---------------------|--------------------|------------------------|--------------|
| J235 | 4-1/16 | 3/4 | 5/8 | 11/64 | 0.10 |



THIN NOSE PLIERS

- › Easy access to tight areas.
- › Has two jaw positions and shear type wire cutter.
- › Plastisol grips for added comfort.



| Product # | Overall Length (in) (L) | Jaw Length (in) (A) | Jaw Width (in) (B) | Jaw Thickness (in) (C) | Weight (lbs) |
|--------------|-------------------------|---------------------|--------------------|------------------------|--------------|
| J2026 | 6-11/16 | 1-15/16 | 1-1/16 | 3/16 | 0.47 |



ASME B107.500

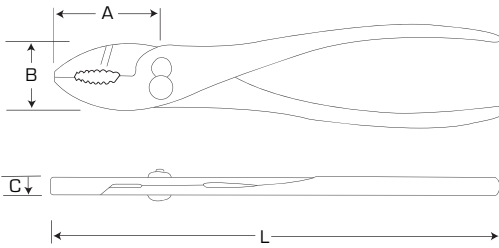

SOFT JAW - CANNON PLUG PLIERS

- › Capacity of 3/4" to 2-1/2".
- › Four position pivot design provides greater concentricity.
- › Replaceable urethane padded jaws protect work piece from marking or scratching.
- › Plastisol grips for added comfort.



| Product # | Overall Length (in) (L) | Max. Opening (in) | Replacement Item | Weight (lbs) |
|--------------|-------------------------|-------------------|------------------|--------------|
| J2536 | 9-1/2 | 3/4 - 2-1/2 | 253GRK | 0.54 |



HOSE CLAMP PLIERS

- › Installs and removes wire spring tension clamps.
- › Two position jaws grip full range of clamp sizes.
- › Plastisol grips for added comfort.



| Product # | Overall Length (in) (L) | Weight (lbs) |
|--------------|-------------------------|--------------|
| J2526 | 7-3/4 | 0.56 |



NEEDLE-NOSE PLIERS

- › Diamond serrated jaws.
- › Plastisol grips for added comfort.



| Product # | Overall Length (in) (L) | Jaw Length (in) (A) | Jaw Width (in) (B) | Jaw Thickness (in) (C) | Weight (lbs) |
|-----------------|-------------------------|---------------------|--------------------|------------------------|--------------|
| J2826 | 4-7/8 | 1-3/16 | 7/16 | 1/4 | 0.16 |
| J229-036 | 5-9/16 | 1-11/16 | 1/2 | 9/32 | 0.23 |
| J2206 | 6-5/8 | 1-7/8 | 11/16 | 3/8 | 0.35 |

 ASME B107.500

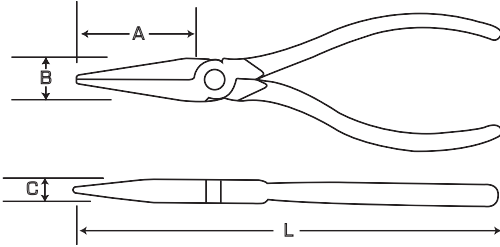

NEEDLE-NOSE PLIERS - COIL SPRING

- › Coil spring.
- › Diamond serrated jaws.
- › Plastisol grips for added comfort.



| Product # | Overall Length (in) (L) | Jaw Length (in) (A) | Jaw Width (in) (B) | Jaw Thickness (in) (C) | Weight (lbs) |
|----------------|-------------------------|---------------------|--------------------|------------------------|--------------|
| J282B56 | 5 | 1-3/16 | 7/16 | 1/4 | 0.16 |

 ASME B107.500

NEEDLE-NOSE PLIERS WITH CUTTER

- › Induction hardened cutting edges.
- › Diamond serrated jaws.
- › Plastisol grips for added comfort.

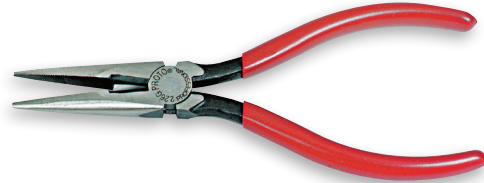

| Product # | Overall Length (in) (L) | Jaw Length (in) (A) | Jaw Width (in) (B) | Jaw Thickness (in) (C) | Weight (lbs) |
|--------------|-------------------------|---------------------|--------------------|------------------------|--------------|
| J2266 | 6-5/8 | 1-7/8 | 11/16 | 3/8 | 0.34 |

 ASME B107.500

NEEDLE-NOSE PLIERS WITH CUTTER - COIL SPRING

- › Induction hardened cutting edges.
- › Diamond serrated jaws.
- › Coil spring.
- › Plastisol grips for added comfort.



| Product # | Overall Length (in) (L) | Jaw Length (in) (A) | Jaw Width (in) (B) | Jaw Thickness (in) (C) | Weight (lbs) |
|-----------------|-------------------------|---------------------|--------------------|------------------------|--------------|
| J229-016 | 5-9/16 | 1-11/16 | 1/2 | 9/32 | 0.23 |
| J226-016 | 7-1/2 | 2-5/8 | 3/4 | 3/8 | 0.40 |

 ASME B107.500



NEEDLE-NOSE PLIERS - LONG REACH

- › Extra-long handle allows greater access to confined, restricted areas.
- › Improved fulcrum point provides more holding power at the tip with less gripping effort.
- › Plastisol grips for added comfort.



| Product # | Overall Length (in) (L) | Jaw Length (in) (A) | Jaw Width (in) (B) | Jaw Thickness (in) (C) | Weight (lbs) |
|--------------|-------------------------|---------------------|--------------------|------------------------|--------------|
| J240G | 11-9/16 | 2-13/16 | 23/32 | 13/32 | 0.63 |

NEEDLE-NOSE PLIERS - LONG

- › Long handle for added leverage.
- › Diamond serrated jaws.
- › Plastisol grips for added comfort.



| Product # | Overall Length (in) (L) | Jaw Length (in) (A) | Jaw Width (in) (B) | Jaw Thickness (in) (C) | Weight (lbs) |
|--------------|-------------------------|---------------------|--------------------|------------------------|--------------|
| J228G | 7-25/32 | 1-9/16 | 17/32 | 7/16 | 0.38 |



ASME B107.500

NEEDLE-NOSE PLIERS - LONG THIN

- › Very thin nose allows access into minimum clearance areas.
- › Diamond serrated jaws.
- › Plastisol grips for added comfort.

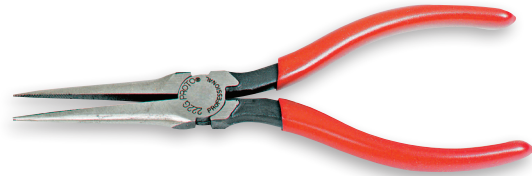

| Product # | Overall Length (in) (L) | Jaw Length (in) (A) | Jaw Width (in) (B) | Jaw Thickness (in) (C) | Weight (lbs) |
|--------------|-------------------------|---------------------|--------------------|------------------------|--------------|
| J222G | 6-1/16 | 2-1/8 | 11/16 | 11/32 | 0.28 |



ASME B107.500

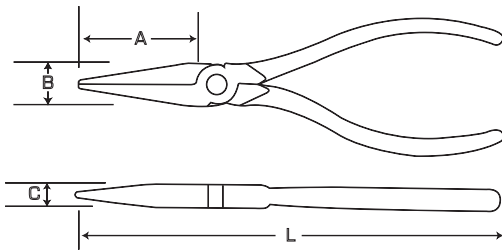

NEEDLE-NOSE PLIERS - LONG EXTRA THIN

- › Extra slim-nose pliers for light precision work.
- › Designed for gripping, looping, and twisting wire in confined areas.
- › Plastisol grips for added comfort.

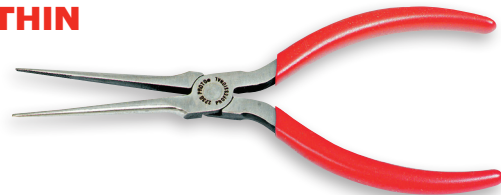

| Product # | Overall Length (in) (L) | Jaw Length (in) (A) | Jaw Width (in) (B) | Jaw Thickness (in) (C) | Weight (lbs) |
|--------------|-------------------------|---------------------|--------------------|------------------------|--------------|
| J223G | 6-5/32 | 2-5/32 | 1/2 | 9/32 | 0.20 |



ASME B107.500

BENT NOSE-NEEDLE NOSE PLIERS

- › Nose bent to 78° angle to reach around obstructions.
- › Very thin nose allows access into minimum clearance areas.
- › Diamond serrated jaws.
- › Plastisol grips for added comfort.

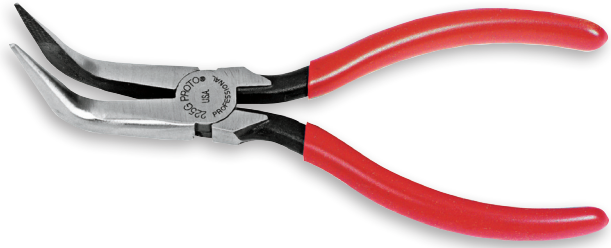

| Product # | Overall Length (in) (L) | Jaw Length (in) (A) | Jaw Width (in) (B) | Jaw Thickness (in) (C) | Weight (lbs) |
|--------------|-------------------------|---------------------|--------------------|------------------------|--------------|
| J2256 | 6-5/16 | 1-5/8 | 3/4 | 3/8 | 0.42 |

ASME B107.500

BENT NOSE NEEDLE-NOSE PLIERS - LONG REACH

- › Extra-long handle allows greater access to confined, restricted areas.
- › Improved fulcrum point provides more holding power at the tip with less gripping effort.
- › Bent nose design to reach around obstructions.
- › Plastisol grips for added comfort.



| Product # | Overall Length (in) (L) | Jaw Length (in) (A) | Jaw Width (in) (B) | Jaw Thickness (in) (C) | Weight (lbs) |
|--------------|-------------------------|---------------------|--------------------|------------------------|--------------|
| J2416 | 11-3/8 | 2-9/16 | 23/32 | 13/32 | 0.62 |

ASME B107.500

DUCKBILL PLIERS

- › Wide, flat nose for better grip than standard needle-nose pliers.
- › Diamond serrated jaws.
- › Long handle for added leverage.
- › Plastisol grips for added comfort.



| Product # | Overall Length (in) (L) | Jaw Length (in) (A) | Jaw Width (in) (B) | Jaw Thickness (in) (C) | Weight (lbs) |
|--------------|-------------------------|---------------------|--------------------|------------------------|--------------|
| J2276 | 7-25/32 | 1-9/16 | 17/32 | 7/16 | 0.38 |

ASME B107.500

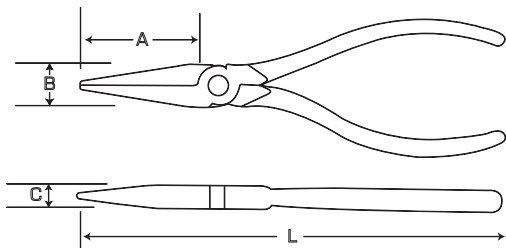



DIAGONAL CUTTING PLIERS

- › Induction hardened cutting edges.
- › Thin narrow jaws for access in tight areas.
- › Plastisol grips for added comfort.



| Product # | Overall Length (in) (L) | Jaw Length (in) (A) | Jaw Width (in) (B) | Jaw Thickness (in) (C) | Weight (lbs) |
|--------------|-------------------------|---------------------|--------------------|------------------------|--------------|
| J285G | 4-5/8 | 13/32 | 7/16 | 1/4 | 0.13 |
| J204G | 4-7/16 | 18/32 | 9/16 | 5/16 | 0.22 |
| J205G | 5-1/16 | 3/4 | 19/32 | 3/8 | 0.24 |
| J206G | 6-1/16 | 13/16 | 3/4 | 7/16 | 0.40 |
| J207G | 7-5/16 | 1 | 7/8 | 15/32 | 0.50 |



ASME B107.500

DIAGONAL CUTTING PLIERS - COIL SPRING

- › Coil springs.
- › Induction hardened cutting edges.
- › Thin narrow jaws for access in tight areas.
- › Plastisol grips for added comfort.

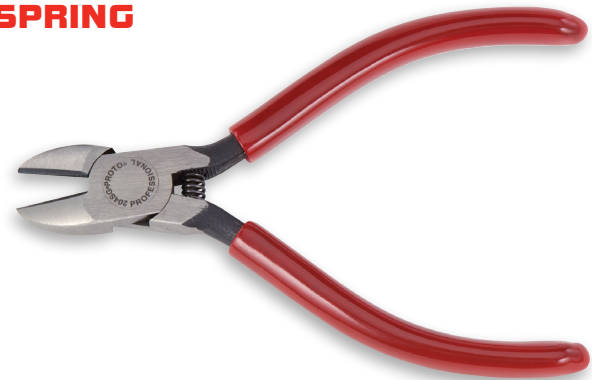

| Product # | Overall Length (in) (L) | Jaw Length (in) (A) | Jaw Width (in) (B) | Jaw Thickness (in) (C) | Weight (lbs) |
|----------------|-------------------------|---------------------|--------------------|------------------------|--------------|
| J285BSG | 4-5/8 | 13/32 | 7/16 | 1/4 | 0.13 |
| J204SG | 4-7/16 | 18/32 | 9/16 | 5/16 | 0.22 |



ASME B107.500

DIAGONAL CUTTING PLIERS - ANGLED HEAD

- › Angled head for work in confined areas.
- › Plastisol grips for added comfort.



| Product # | Overall Length (in) (L) | Jaw Length (in) (A) | Jaw Width (in) (B) | Jaw Thickness (in) (C) | Weight (lbs) |
|----------------|-------------------------|---------------------|--------------------|------------------------|--------------|
| J210AHG | 8-1/8 | 3/4 | 1-7/32 | 5/32 | 0.64 |

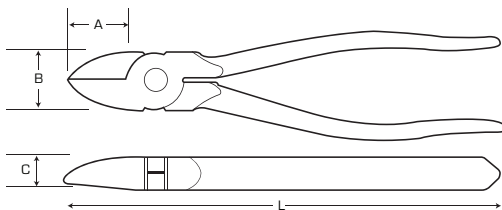

HEAVY-DUTY DIAGONAL CUTTING PLIERS

- › Induction hardened cutting edge.
- › Powerful leverage cuts heavy wire with ease.
- › Plastisol grips for added comfort.

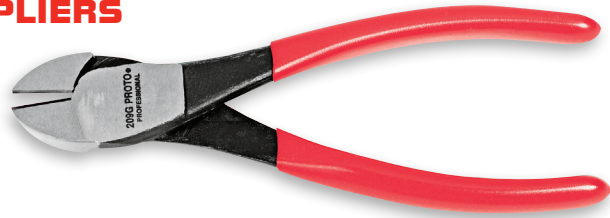

| Product # | Overall Length (in) (L) | Jaw Length (in) (A) | Jaw Width (in) (B) | Jaw Thickness (in) (C) | Weight (lbs) |
|--------------|-------------------------|---------------------|--------------------|------------------------|--------------|
| J209G | 7-5/16 | 2-5/32 | 7/8 | 1/2 | 0.58 |
| J210G | 8-1/2 | 3/4 | 1-7/32 | 15/32 | 0.64 |

 ASME B107.500

DIAGONAL PLASTIC CUTTING PLIERS

- › Adjusting set screw allows fast, precise cutting and prevents cutting edges from damaging each other.
- › Coil spring for reduced hand fatigue.
- › Induction hardened cutting edges.
- › Plastisol grips for added comfort

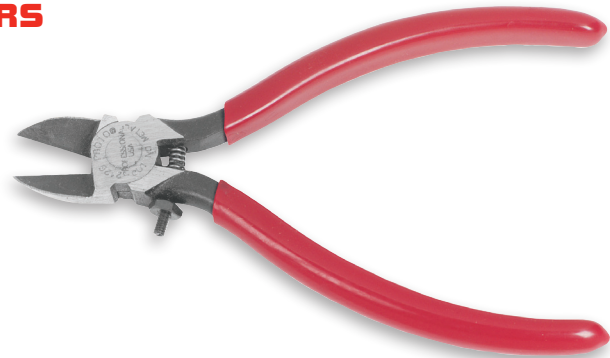

| Product # | Overall Length (in) (L) | Jaw Length (in) (A) | Jaw Width (in) (B) | Jaw Thickness (in) (C) | Weight (lbs) |
|--------------|-------------------------|---------------------|--------------------|------------------------|--------------|
| J212G | 6-1/16 | 3/4 | 3/4 | 7/16 | 0.39 |
| J213G | 7-5/16 | 1 | 29/32 | 1/2 | 0.53 |



HIGH LEVERAGE DIAGONAL CUTTING PLIERS LONG REACH - ANGLED HEAD

- › Extra-long handle provides high leverage cutting capabilities with less user effort.
- › 30° angled head for hard-to-reach areas.
- › Wide handle contour for less fatigue.
- › Plastisol grips for added comfort.



| Product # | Overall Length (in) (L) | Jaw Length (in) (A) | Jaw Width (in) (B) | Jaw Thickness (in) (C) | Weight (lbs) |
|--------------|-------------------------|---------------------|--------------------|------------------------|--------------|
| J244G | 11-1/8 | 1 | 63/64 | 1-5/32 | 0.94 |





DIAGONAL CUTTING PLIERS LONG REACH - GRIPPING TIP

- › Cutting and gripping capabilities in one tool.
- › Serrated gripping surface at tips.
- › Plastisol grips for added comfort.



| Product # | Overall Length (in) (L) | Jaw Length (in) (A) | Jaw Width (in) (B) | Jaw Thickness (in) (C) | Weight (lbs) |
|--------------|-------------------------|---------------------|--------------------|------------------------|--------------|
| J246G | 11-1/8 | 27/32 | 63/64 | 25/64 | 0.74 |



LINEMAN'S PLIERS

- › For utility linemen, wiring and electrical equipment installation, and maintenance.
- › Induction hardened cutting edges and diamond serrated jaws.
- › Built-in insulation crusher
- › Plastisol grips for added comfort.

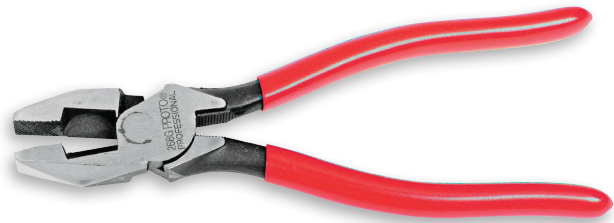

| Product # | Overall Length (in) (L) | Jaw Length (in) (A) | Jaw Width (in) (B) | Jaw Thickness (in) (C) | Weight (lbs) |
|--------------|-------------------------|---------------------|--------------------|------------------------|--------------|
| J268G | 8-5/8 | 1-1/2 | 1-3/16 | 5/8 | 0.98 |



ASME B107.500

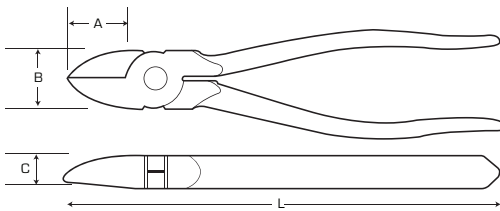

LINEMAN'S PLIERS - NEW ENGLAND STYLE

- › Slim rounded nose for easy access in restricted spaces.
- › Diamond serrated jaws.
- › Plastisol grips for added comfort.

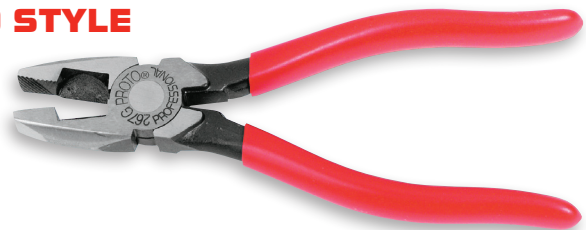

| Product # | Overall Length (in) (L) | Jaw Length (in) (A) | Jaw Width (in) (B) | Jaw Thickness (in) (C) | Weight (lbs) |
|--------------|-------------------------|---------------------|--------------------|------------------------|--------------|
| J266G | 6-3/16 | 1-3/32 | 29/32 | 1/2 | 0.50 |
| J267G | 7-1/4 | 1-9/32 | 1-1/8 | 1/2 | 0.67 |



ASME B107.500

LINEMAN'S PLIERS - HIGH LEVERAGE

- › Jaws have offset rivet for increased leverage.
- › Designed for cutting No. 8 and other large wires.
- › Diamond serrated jaws.
- › Plastisol grips for added comfort.



| Product # | Overall Length (in) (L) | Jaw Length (in) (A) | Jaw Width (in) (B) | Jaw Thickness (in) (C) | Weight (lbs) |
|-----------|-------------------------|---------------------|--------------------|------------------------|--------------|
| J2696 | 9-1/4 | 1-3/16 | 1-3/32 | 5/8 | 1.10 |

ASME B107.500

LINEMAN'S PLIERS - PIPE JAW

- › Serrated flat nose jaws with toothed pipe grip.
- › Plastisol grips for added comfort.



| Product # | Overall Length (in) (L) | Jaw Length (in) (A) | Jaw Width (in) (B) | Jaw Thickness (in) (C) | Weight (lbs) |
|-----------|-------------------------|---------------------|--------------------|------------------------|--------------|
| J268PJG | 8-3/8 | 1-3/4 | 1-1/16 | 17/32 | 0.87 |

IRON WORKER'S PLIERS

- › Designed to tie and cut wire associated with reinforcing bar.
- › Hook bend in handle to reduce slippage when gripping and pulling.
- › Coil spring holds jaws open, yet close easily.
- › Plastisol grips for added comfort.

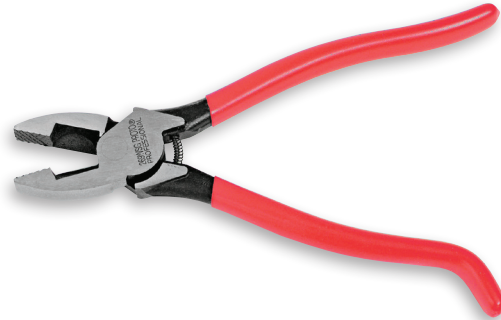

| Product # | Overall Length (in) (L) | Jaw Length (in) (A) | Jaw Width (in) (B) | Jaw Thickness (in) (C) | Weight (lbs) |
|-----------|-------------------------|---------------------|--------------------|------------------------|--------------|
| J269WSG | 9-1/4 | 1-9/16 | 1-9/32 | 5/8 | 1.16 |

END-CUTTING PLIERS - HIGH LEVERAGE

- › Semi-flush cutting in areas inaccessible to side-cutting pliers.
- › High leverage for easy cutting of most wires and nails.
- › Plastisol grips for added comfort.



| Product # | Overall Length (in) (L) | Jaw Length (in) (A) | Jaw Width (in) (B) | Jaw Thickness (in) (C) | Weight (lbs) |
|-----------|-------------------------|---------------------|--------------------|------------------------|--------------|
| J2726 | 8-1/4 | 5/16 | 1-3/4 | 1-3/16 | 0.90 |

ASME B107.500



ANATOMY OF PROTO® LOCKING PLIERS

Designed by engineers who look at each problem with fresh eyes, no matter how simple, each Proto® tool brings quality, durability and accuracy to the job site.

Locking mechanism helps leave both hands free when clamping, helping to eliminate squeezing action and general hand fatigue when manipulating.

• High corrosion resistant finish with welding spatter resistance.

• Large diameter rivets to provide secure joints adding to the durability and robustness of the tools.

Tip of release lever projects at end of handle for a quick, no-pinch, powerful release especially when tools are firmly locked.

Spring-loaded release lever is out of the way when handling.

Holes in mobile jaw are drilled, not press punched to ensure cylindrical shape and maximum bearing with rivets.

Drop forged jaws and rugged tooth profile for durability and toughness.



5 PIECE LOCKING PLIERS WELDING SET

Product #: **JWK5XL**

- › Set designed for welding applications.
- › Locking mechanism helps leave both hands free when clamping, helping to eliminate squeezing action and general hand fatigue when manipulating.
- › High corrosion resistant finish with welding spatter resistance.

| Contents | Description |
|----------|---|
| J281XL | Pliers, Locking Optimum Grip 9-27/32" |
| J301XL | Pliers, Locking Plug Weld Pliers 9-41/64" |
| J286LNXL | Pliers, Locking Mini Long Nose 6-29/32" |
| J274XL | Pliers, Locking Aluminum Alloy C-Clamp 11-5/12" |
| JMICROXL | Pliers, Micro Grip Clamp 3-5/8" |



3 PIECE LOCKING PLIERS SET

Product #: **J299RXL**

- › Locking mechanism helps leave both hands free when clamping, helping to eliminate squeezing action and general hand fatigue when manipulating.
- › Tip of release lever projects at end of handle for a quick, no-pinch, powerful release especially when tools are firmly locked.
- › Spring-loaded release lever is out of the way when handling.
- › Drop forged jaws and rugged tooth profile for durability and toughness.
- › Holes in mobile jaw are drilled and not press punched to ensure they are cylindrical to ensure maximum bearing with rivets. (Punched holes tend give poor bearing.)
- › Large diameter of rivets to help permit secure joints adding to the durability and robustness of the tools.
- › Piano wire spring for smooth and efficient jaw opening.



| Contents | Description |
|----------|---|
| J292XL | Pliers, Locking Curved Jaw 9-1/4" |
| J291XL | Pliers, Locking Straight Jaw 7-15/32" |
| J286LNXL | Pliers, Locking Mini Long Nose 6-29/32" |
| J25TR22C | Tool Roll |

3 PIECE LOCKING PLIERS SET - NICKEL CHROME

Product #: **J299NC**

- › Locking mechanism helps leave both hands free when clamping, helping to eliminate squeezing action and general hand fatigue when manipulating.
- › Tip of release lever projects at end of handle for a quick, no-pinch, powerful release especially when tools are firmly locked.
- › Spring-loaded release lever is out of the way when handling.
- › Drop forged jaws and rugged tooth profile for durability and toughness.
- › Holes in mobile jaw are drilled and not press punched to ensure they are cylindrical to ensure maximum bearing with rivets. (Punched holes tend give poor bearing.)
- › Large diameter of rivets to help permit secure joints adding to the durability and robustness of the tools.
- › Piano wire spring for smooth and efficient jaw opening.



| Contents | Description |
|----------|---|
| J292NC | Pliers, Nickel Chrome Locking Curved - 9-1/4" |
| J291NC | Pliers, Nickel Chrome Locking Straight - 7-15/32" |
| J286NC | Pliers, Nickel Chrome Needle-Nose - 6-7/8" |
| J25TR22C | Tool Roll |

OPTIMUM GRIP LOCKING PLIERS

- › Jaw configuration combining straight, curved and convex profiles.
- › Versatile tool securely gripping round, flat and large objects.
- › Multi-use for plumbers, welders and others.



| Product # | Overall Length (in) (L) | Jaw Length (in) (A) | Jaw Width (in) (B) | Jaw Thickness (in) (C) | Weight (lbs) |
|---------------|-------------------------|---------------------|--------------------|------------------------|--------------|
| J280XL | 7-7/8 | 1-25/32 | 27/64 | 27/64 | 0.90 |
| J281XL | 9-27/32 | 2-5/32 | 1/2 | 1/2 | 1.43 |



CURVED JAW LOCKING PLIERS

- › Narrow large opening curved shaped jaws.
- › Allows firm hold on all round shapes.
- › Universal tool for multi-use.

| Product # | Overall Length (in) (L) | Jaw Width (in) (B) | Weight (lbs) |
|---------------|-------------------------|--------------------|--------------|
| J290XL | 7-15/32 | 11/32 | 0.82 |
| J292XL | 9-1/4 | 25/64 | 1.32 |



CURVED JAW LOCKING PLIERS WITH CUTTER

- › Wide jaw profile with wire cutter.
- › Two tools in one.
- › Multi-functional use.

| Product # | Overall Length (in) (L) | Jaw Width (in) (B) | Weight (lbs) |
|-----------------|-------------------------|--------------------|--------------|
| J292WRXL | 9-4/11 | 1/2 | 1.32 |
| J293WRXL | 5-1/2 | 21/64 | 0.40 |
| J294WRXL | 7-15/32 | 11/32 | 0.82 |



STRAIGHT JAW LOCKING PLIERS

- › Heavy-duty nose.
- › Reinforced precisely machined teeth.
- › Strong, tough tool.
- › Helps provide secure grip for extra tough jobs.
- › General purpose for various maintenance situations.
- › Locking nut to hold adjustment during repetitive jobs.

| Product # | Overall Length (in) (L) | Jaw Width (in) (B) | Weight (lbs) |
|---------------|-------------------------|--------------------|--------------|
| J291XL | 7-15/32 | 1/2 | 0.88 |
| J293XL | 9-1/4 | 5/8 | 1.39 |



GROOVED GRIP LOCKING PLIERS

- › Tapered groove in mobile jaw.
- › Convex jaw.
- › Firm hold of cylindrical objects without lateral movement.
- › Clears small obstacles.
- › Ideal for holding and handling drill bits, taps, fasteners and tubes in general maintenance work.

| Product # | Overall Length (in) (L) | Weight (lbs) |
|---------------|-------------------------|--------------|
| J282XL | 9-7/16 | 1.32 |



LONG NOSE LOCKING PLIERS

- › Long slim jaw design.
- › Curved section.
- › Pliers can reach deep into recessed areas.
- › Can hold rounded objects.
- › Great for holding, placing and extracting pieces in awkward areas, engines, etc.

| Product # | Overall Length (in) (L) | Jaw Width (in) (B) | Weight (lbs) |
|-----------|-------------------------|--------------------|--------------|
| J289LNXL | 9-1/32 | 25/64 | 0.88 |
| J286LNXL | 6-29/32 | 5/16 | 0.42 |



LOCKING CHAIN PLIERS

- › Flexible heavy-duty, heat-treated chain which adjusts quickly around any shaped object even in awkward areas.
- › Use to remove oil filters or holding odd shapes for welding.
- › Replacement chain available - J262RC

| Product # | Overall Length (in) (L) | Jaw Width (in) (B) | Weight (lbs) |
|-----------|-------------------------|--------------------|--------------|
| J262XL | 9-27/32 | 45/64 | 1.98 |



LOCKING CHAIN PIPE CUTTER

- › 13 Alloy steel cutting wheels to evenly cut difficult to reach thin wall pipes by hand ratcheting.
- › Locking mechanism - no squeezing, avoids risk of lateral movement and misaligned cutting.
- › Butterfly screw for easy feeding as cutting.
- › Cuts through steel, copper, aluminum, and some stainless steels.
- › Great for exhaust pipe repair and removal.
- › Use in plumbing and heating.
- › Replacement chain available - J263RC

| Product # | Overall Length (in) (L) | Jaw Width (in) (B) | Weight (lbs) |
|-----------|-------------------------|--------------------|--------------|
| J263XL | 9-27/32 | 1-3/32 | 1.76 |



LOCKING CHAIN PIPE CUTTER PLUS

- › 15 Alloy steel cutting wheels to evenly cut difficult to reach piping up to 1/4 / 6 mm wall thickness by hand ratcheting.
- › Locking mechanism - no squeezing, avoids risk of lateral movement and misaligned cutting.
- › Cuts through galvanized steel, some stainless steels, copper, PVC, and aluminum.
- › Problem solving and time saving, ideal for plumbing, heating, joinery, and general maintenance.
- › Replacement chain available - J264RC

| Product # | Overall Length (in) (L) | Jaw Width (in) (B) | Weight (lbs) |
|-----------|-------------------------|--------------------|--------------|
| J264XL | 11-9/11 | 1-11/64 | 2.76 |





LOCKING SHEET METAL TOOL

- › Wide jaw profile to allow powerful grip on large thin surfaces.
- › Clamps, forms, bends, and crimps sheet metal.

| Product # | Overall Length (in) (L) | Jaw Width (in) (B) | Weight (lbs) |
|---------------|-------------------------|--------------------|--------------|
| J260XL | 8-1/16 | 3-9/64 | 1.15 |



LOCKING PLUG WELD PLIERS

- › Copper alloy knurled swivel pad to help prevent burn through when plug welding thin sheet metal. Plug welding is advised in most American Collision Repair Procedure Manuals.
- › U-shaped mobile jaw to help provide even pressure around spot to be welded.
- › Appropriate for general maintenance work.

| Product # | Overall Length (in) (L) | Weight (lbs) |
|---------------|-------------------------|--------------|
| J301XL | 9-16/25 | 1.12 |



LOCKING WELDING PLIERS

- › Firmly holds two sections together. Hands free solution in general welding and body work.
- › U-shaped jaw profile: Permits the clamping of adjacent joints and perfect visibility when welding.

| Product # | Overall Length (in) (L) | Jaw Width (in) (B) | Weight (lbs) |
|---------------|-------------------------|--------------------|--------------|
| J261XL | 9-1/32 | 2-3/4 | 1.54 |



LOCKING STEEL CLAMPS

- › Wide and deep jaw profile to help clear obstacles and firmly clamp sections which locking pliers can not.
- › Clamp in close quarters for auto body work and welding shops.



| Product # | Overall Length (in) (L) | Jaw Width (in) (B) | Jaw Thickness (in) (C) | Weight (lbs) |
|---------------|-------------------------|--------------------|------------------------|--------------|
| J265XL | 6-8/11 | 5/16 | 1-61/64 | 0.53 |
| J266XL | 11-1/5 | 15/32 | 3-15/16 | 1.96 |
| J267XL | 18-1/2 | 15/32 | 10-15/64 | 2.87 |
| J268XL | 24-27/64 | 15/32 | 15-47/64 | 3.31 |

LOCKING C-CLAMPS WITH SWIVEL PADS

- › Knurled swivel pads - allow non-slip no damage parallel clamping even on tapered surfaces.
- › J269XL—Small in size for delicate and fine work—ideal for electronics.
- › Safely clamps delicate surfaces - wood, plastic, and soft materials.

| Product # | Overall Length (in) (L) | Jaw Width (in) (B) | Weight (lbs) |
|---------------|-------------------------|--------------------|--------------|
| J269XL | 6-1/2 | 3/4 | 0.60 |
| J270XL | 12-19/32 | 1-11/64 | 2.20 |
| J271XL | 14-3/8 | 5-1/2 | 2.70 |
| J272XL | 18-1/2 | 10-15/64 | 3.20 |
| J273XL | 24-8/9 | 1-11/64 | 4.00 |



LOCKING PIPE CLAMP

- › Undulated U-shaped jaws to help allow secure clamping on rounded sections and perfect visibility for welding.
- › Holds two pipes well aligned for accurate welding in plumbing and general pipe and tube manipulation.

| Product # | Overall Length (in) (L) | Jaw Width (in) (B) | Weight (lbs) |
|---------------|-------------------------|--------------------|--------------|
| J283XL | 11-3/5 | 2-3/4 | 2.12 |



ERGO GRIP LOCKING PLIERS

- › Long jaw with straight and curved profiles for multiple applications.
- › Cushion grip helps reduce slippage with added comfort.
- › 70° angled design - allows exertion of up to 50% more force in twisting applications.
- › Helps keep wrist straight, reducing strain and general fatigue.
- › Allows use in areas of limited space.

| Product # | Overall Length (in) (L) | Weight (lbs) |
|---------------|-------------------------|--------------|
| J300XL | 7-3/32 | 0.83 |





LOCKING ALUMINUM ALLOY C-CLAMPS

- › Modern ergonomic clamps with aircraft aluminum alloy jaws for professional welding and metal work.
- › Light weight for comfort and ease of handling for the intensive user.
- › Spatter resistant material to ensure good working order and helps avoid tiresome cleaning.
- › Heat-treated die cast jaws to ensure resist and durability.

| Product # | Overall Length (in) (L) | Jaw Width (in) (B) | Weight (lbs) |
|---------------|-------------------------|--------------------|--------------|
| J274XL | 11-5/12 | 15/32 | 1.48 |
| J275XL | 14-2/11 | 45/64 | 1.92 |



LOCKING ALUMINUM ALLOY U-CLAMP

- › Lightweight to help lower risk of warping and distorting of auto body panels especially new aluminum alloy panels. Also for comfort and easy handling for the intensive user.
- › Welding panels are designed to not adhere to aluminum to help ensure working order and tiresome cleaning of tools.
- › Aluminum will not weld to work piece – no hassle, time saver.
- › Jaws are made from heat-treated die cast aluminum alloy for resistance and durability.

| Product # | Overall Length (in) (L) | Jaw Width (in) (B) | Weight (lbs) |
|---------------|-------------------------|--------------------|--------------|
| J276XL | 9-3/5 | 2-3/4 | 1.63 |



MICRO GRIP CLAMP

- › Small locking clamp.
- › Ideal for even heavy-duty jobs in difficult to reach areas.
- › Applications: Auto body repair and metal fabrication.

| Product # | Overall Length (in) (L) | Jaw Width (in) (B) | Weight (lbs) |
|-----------------|-------------------------|--------------------|--------------|
| JMICROXL | 3-5/8 | 3/4 | 1.12 |



NICKEL CHROME LOCKING PLIERS

- › High tensile strength microalloy steel.
- › Long slim jaw design.
- › Curved section.
- › Pliers can reach deep into recessed areas.
- › Can hold rounded objects.
- › Great for holding, placing and extracting pieces in awkward areas, engines, etc.

| Product # | Overall Length (in) (L) | Jaw Width (in) (B) | Weight (lbs) |
|---------------|-------------------------|--------------------|--------------|
| J266NC | 11-1/5 | 15/32 | 1.96 |
| J286NC | 6-7/8 | 5/16 | 0.42 |
| J291NC | 7-15/32 | 1/2 | 0.88 |
| J292NC | 9-1/4 | 25/64 | 1.32 |
| J293NC | 10 | 5/8 | 1.48 |



4 PIECE HANDS FREE KIT

- › (2) J281XL 10" Optimum Grip.
- › (2) JGHXL 6" Grip Holder.
- › A true hands free work holding system.
- › Secure the holder, insert the locking pliers and you have a portable vice.

| Product # | Weight (lbs) |
|---------------|--------------|
| JHK4XL | 4.63 |



LOCKING GRIP HOLDERS

- › Designed with special slot.
- › Swivel pad.
- › Butterfly screw.
- › Firmly holds 10" tools converting them into a versatile portable vise.
- › Helps ensure firm hold on all work pieces.
- › Easy to adjust.
- › Use a standard c-clamp or combined with locking tools for a hands free work.

| Product # | Overall Length (in) (L) | Weight (lbs) |
|---------------|-------------------------|--------------|
| JGHXL | 5-5/32 | 0.55 |
| JMGHXL | 5-5/32 | 0.66 |



SAFETY WIRE TWISTER PLIERS - DEEP REACH

- › Designed for access into close clearance areas.

| Product # | Overall Length (in) (L) | Weight (lbs) |
|-------------|-------------------------|--------------|
| J193 | 18-1/8 | 0.43 |





SAFETY WIRE TWISTER PLIERS

- › Safety wire is often used in aviation and other applications where vibration may cause fasteners to back out.
- › Heat-treated cutting edges for cutting tough stainless steel safety wire.
- › Flat top diamond serrations on jaws hold wire securely and resist nicking.
- › Diagonal nose allows access in tight work areas.
- › Automatic spring return feature speeds operation and reduces fatigue.
- › J190 designed for wire sizes .020" - .041".
- › J191, J192, J195 designed for wire sizes .020" - .060".
- › J192 Ergonomically designed.
- › J195 Left hand twist.



| Product # | Overall Length (in) (L) | Weight (lbs) |
|-------------|-------------------------|--------------|
| J190 | 8-3/8 | 0.59 |
| J191 | 10-3/8 | 0.85 |
| J192 | 10-3/8 | 0.85 |
| J195 | 10-3/8 | 0.85 |

 ASME B107.500

SAFETY WIRE TWISTER PLIERS - REVERSIBLE

- › Reversible safety wire pliers provide right and left twist capability often eliminating the need for a second plier.
- › Meets SAE Aerospace Standard AS 567 Twister Requirements.
- › Provides all of the features of standard Proto® Safety Wire Pliers.
- › J196 designed for wire sizes .020" - .041".
- › J197 designed for wire sizes .020" - .060".
- › J198 designed for wire sizes .020" - 0.60".



| Product # | Overall Length (in) (L) | Weight (lbs) |
|-------------|-------------------------|--------------|
| J196 | 8-3/4 | 0.64 |
| J197 | 11 | 0.88 |
| J198 | 12-1/4 | 0.91 |



3 PIECE SAFETY WIRE TWISTER PLIERS SET

Product #: J194

- › Contains three different twisters to cover almost any application.
- › Includes 6" and 9" wire twister pliers and deep reach pliers.
- › Packed in handy, durable plastic storage case.



| Contents | Description | Length (in) |
|----------|---|-------------|
| J190 | Pliers, Wire Twister 6" | 8-3/8 |
| J191 | Pliers, Wire Twister 9" | 10-3/8 |
| J193 | Pliers, Wire Twister Deep Reach 18-1/8" | 18-1/8 |

WIRE STRIPPER - CRIMPER

- › Strips 10-22 AWG (American Wire Gauge).
- › Box style crimp.
- › Crimps insulated and non-insulated terminals for 10-22 AWG.
- › Crimps non-insulated 7 mm and 8 mm auto ignition wire.
- › Cuts screw/bolt sizes 4-40, 5-40, 6-32, 8-32, 10-32, 10-24.
- › Anvil type wire cutter for cutting copper wire.
- › Air-pocket cushion grips for comfort.

| Product # | Overall Length (in) (L) | Weight (lbs) |
|-------------|-------------------------|--------------|
| J299 | 8-1/2 | 0.45 |

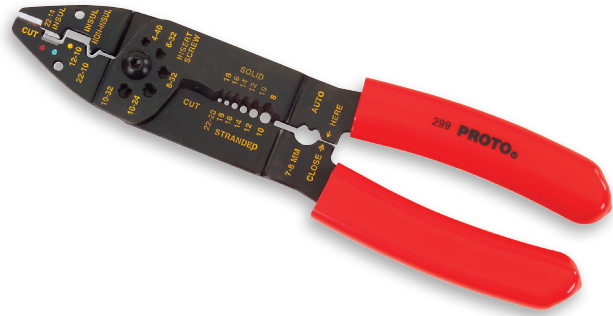

WIRE STRIPPER - CUTTER

- › Strips wire sizes 10, 12, 14, 16, 18, and 20 AWG (American Wire Gauge).
- › Wire cutter for copper wire.
- › Plier nose for pulling and looping wire.
- › Spring return and convenient handle lock.
- › Plastisol grips for added comfort.

| Product # | Overall Length (in) (L) | Weight (lbs) |
|-------------|-------------------------|--------------|
| J297 | 6-1/16 | 0.21 |

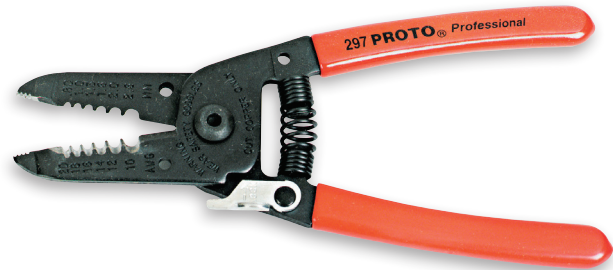

WIRE STRIPPER

- › Strips wire sizes 22, 24, 26, 28, and 30 AWG (American Wire Gauge).
- › Wire cutter.
- › Plier nose for pulling and looping wire.
- › Automatic spring return.
- › Plastisol grips for added comfort.

| Product # | Overall Length (in) (L) | Weight (lbs) |
|-------------|-------------------------|--------------|
| J296 | 6-1/16 | 0.21 |

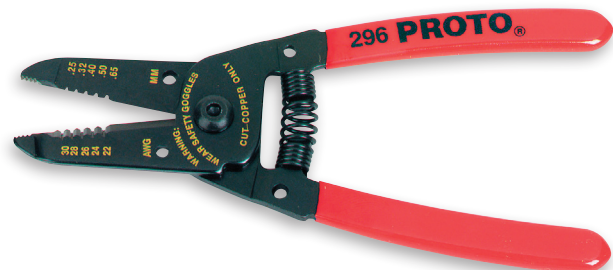

CABLE CUTTER

- › Cuts up to 3/0 fine stranded copper battery cable (not for use on steel cable).
- › Precision ground blades minimize deflection.
- › Positive fastener maintains pressure on matching cutting surfaces.
- › Plastisol grips for added comfort.

| Product # | Overall Length (in) (L) | Weight (lbs) |
|-------------|-------------------------|--------------|
| J288 | 7-1/2 | 0.56 |





WIRE STRIPPERS - PLIERS

- › Strips 10-22 AWG (American Wire Gauge).
- › Crimps insulated and non-insulated terminals for 10-22 AWG wire.
- › Crimps non-insulated 7mm and 8mm auto ignition wire.
- › Cuts screw/bolt sizes 4-40, 5-40, 6-32, 8-32, 10-32, 10-24 and copper wire.
- › Extended length curved cutter to handle heavier wire with less force.
- › Plier nose designed to grip, bend, and pull wire.
- › Plastisol grips for added comfort.

| Product # | Overall Length (in) (L) | Weight (lbs) |
|-------------|-------------------------|--------------|
| J298 | 8-1/4 | 0.05 |



LOCK RING "HORSESHOE" WASHER PLIERS

- › For spreading both soft iron "horseshoe" lock washers used on brakes and tempered steel lock rings used on gear and bearing shafts.
- › Plastisol grips for added comfort.

| Product # | Overall Length (in) (L) | Weight (lbs) |
|--------------|-------------------------|--------------|
| J250G | 7-13/16 | 0.49 |



LOCK RING PLIERS - PARALLEL JAW

- › For removal of lock snap rings used on bearing shafts.
- › Compound leverage simplifies removal.
- › Jaw tips are indented to hold ring ends and prevent breakage.
- › Jaws spread 1-1/4".
- › Plastisol grips for added comfort.

| Product # | Overall Length (in) (L) | Weight (lbs) |
|--------------|-------------------------|--------------|
| J251G | 10-9/16 | 0.68 |



12 PIECE CONVERTIBLE RETAINING RING PLIERS SET

Product #: **J360B**

- › Convenient blow-molded carrying case includes storage for spare rings.
- › Ring range: External (Shaft) 1/4"-3-11/32"; Internal (Bore) 3/8" - 3".
- › Weight (lbs): 4.82



| Contents | Tip Size | Tip Angle | Length (in) | Shaft Diameter (in) (External) | Bore Diameter (in) (Internal) | Weight (lbs) |
|----------|----------|-----------|-------------|--------------------------------|-------------------------------|--------------|
| J399 | .038 | 0° | 5-7/8 | 1/4 - 43/64 | 3/8 - 9/16 | 0.15 |
| J370 | .038 | 45° | 5-3/4 | 1/4 - 3/64 | 3/8 - 9/16 | 0.16 |
| J371 | .038 | 90° | 5-11/16 | 1/2 - 25/32 | 3/8 - 9/16 | 0.16 |
| J372 | .047 | 0° | 5-7/8 | 11/16 - 7/8 | 5/8 - 1 | 0.16 |
| J373 | .047 | 45° | 5-3/4 | 11/16 - 7/8 | 5/8 - 1 | 0.15 |
| J374 | .047 | 90° | 5-11/16 | 13/16 - 1 | 5/8 - 1 | 0.16 |
| J385 | .070 | 0° | 7-1/2 | 15/16 - 1-7/16 | 1-1/16 - 13/4 | 0.29 |
| J375 | .070 | 45° | 7-3/8 | 1 - 1-7/16 | 1-1/16 - 13/4 | 0.32 |
| J376 | .070 | 90° | 7-1/8 | 1 - 1/16, 2 | 1-7/16 - 2 | 0.31 |
| J377 | .090 | 0° | 9-1/4 | 1-1/2 - 3-1/2 | 1-13/16 - 3 | 0.54 |
| J378 | .090 | 45° | 9 | 1-1/2 - 3-1/2 | 1-13/16 - 3 | 0.55 |
| J379 | .090 | 90° | 8-5/8 | 1-1/2 - 1-3/4 | 1-13/16 - 3 | 0.56 |

6 PIECE CONVERTIBLE RETAINING RING PLIERS SET

Product #: **J360A**

- › Convenient blow-molded carrying case includes storage for spare rings.
- › Ring range: External (Shaft) 1/4"-3-11/32"; Internal (Bore) 3/8" - 3".
- › Weight (lbs): 2.10



| Contents | Tip Size | Tip Angle | Length (in) | Shaft Diameter (External) | Bore Diameter (Internal) | Weight (lbs) |
|----------|----------|-----------|-------------|---------------------------|--------------------------|--------------|
| J399 | .038 | 0° | 5-7/8 | 1/4 - 43/64 | 3/8 - 9/16 | 0.15 |
| J371 | .038 | 90° | 5-11/16 | 1/2 - 25/32 | 3/8 - 9/16 | 0.16 |
| J372 | .047 | 0° | 5-7/8 | 11/16 - 7/8 | 5/8 - 1 | 0.16 |
| J374 | .047 | 90° | 5-11/16 | 13/16 - 1 | 5/8 - 1 | 0.16 |
| J385 | .070 | 0° | 7-1/2 | 15/16 - 1-7/16 | 1-1/16 - 13/4 | 0.29 |
| J376 | .070 | 90° | 7-1/8 | 1 - 1/16, 2 | 1-7/16 - 2 | 0.31 |

18 PIECE LARGE PLIERS SET WITH REPLACEABLE TIPS

Product #: **J361**

- › Includes one internal and one external plier.
- › Convenient blow-molded carrying case includes storage for spare rings.
- › Custom grip handles for added comfort.
- › Contains 16 interchangeable tips listed below. (Replacements available).
- › Covers ring range:
 - › External 1-1/2" - 3-3/4"
 - › Internal 2-7/16" - 4"
- › Spring-loaded ratchet mechanism minimizes operator fatigue by allowing ring to be compressed or expanded through gradual moves and locks at desired size. Heavy and large rings are safely and easily controlled.
- › Pliers overall length 9-1/2".
- › Weight (lbs): 2.50

| Tip Size | Tip Angle |
|----------|-----------|
| .108 | 0° |
| .108 | 15° |
| .108 | 45° |
| .108 | 90° |
| .120 | 0° |
| .120 | 15° |
| .120 | 45° |
| .120 | 90° |



REPLACEMENT TIPS FOR J361

- › 8 Tips
- › 2 each of .108 Tips in 0°, 15°, 45°, 90°.

| Product # | Weight (lbs) |
|-----------|--------------|
| J362 | 0.22 |

REPLACEMENT TIPS FOR J361

- › 8 Tips
- › 2 each of .120 Tips in 0°, 15°, 45°, 90°.

| Product # | Weight (lbs) |
|-----------|--------------|
| J363 | 0.23 |

4 PIECE CONVERTIBLE RETAINING RING PLIERS SET

Product #: **J360C**

- › Design permits quick change-over to work internal or external rings.
- › Pliers have no screws to tighten.
- › Pliers have a return spring designed to reduce fatigue and facilitate operation.
- › Pliers have air cushioned grips which spreads loads across the hand increasing comfort.
- › Ring range: External (Shaft) 1/4" - 2"; Internal (Bore) 3/8" - 2".
- › Weight (lbs): 1.26



| Contents | Tip Size | Tip Angle | Length (in) | Weight (lbs) |
|----------|----------|-----------|-------------|--------------|
| J399L | .038 | 18° | 6 | 0.19 |
| J371L | .038 | 90° | 6 | 0.19 |
| J385L | .070 | 18° | 7-1/4 | 0.33 |
| J376L | .070 | 90° | 7-1/4 | 0.33 |

18 PIECE SMALL PLIERS SET WITH REPLACEABLE TIPS

Product #: **J380**

- › Includes one internal and one external plier.
- › Covers ring range: External 1/4"-2", Internal 3/8"-2".
- › Contains 16 interchangeable tips (4 of each listed below) (Replacements available).
- › Pliers overall length 6-1/4".
- › Weight: 0.64 lbs

| Tip Size | Tip Angle |
|----------|-----------|
| .038 | 90° |
| .047 | 45° |
| .047 | 0° |
| .070 | 0° |



REPLACEMENT TIPS FOR J380

- › 16 Tips.
- › 4 each of: .038 90°, .047 45°, .047 0°, .070 0°.
- › Plastic storage case.

| Product # | Weight (lbs) |
|--------------|--------------|
| J380T | 0.05 |

RETAINING RING PLIERS - CONVERTIBLE

- › Converts from internal to external or vice versa, when pivot screw is moved to adjacent tapped hole.
- › Use with either External or Internal Retaining Rings.
- › Fixed tips are precision formed and induction hardened for accurate fit and long wear.
- › Use the largest diameter tip that will fit the retaining ring being removed or installed.



| Product # | Tip Size | Tip Angle | Length (in) | Bore Diameter (in) (Internal) | Weight (lbs) |
|--------------|----------|-----------|-------------|-------------------------------|--------------|
| J399 | .038 | 0° | 5-7/8 | 3/8 - 9/16 | 0.15 |
| J370 | .038 | 45° | 5-3/4 | 3/8 - 9/16 | 0.16 |
| J371 | .038 | 90° | 5-11/16 | 3/8 - 9/16 | 0.16 |
| J372 | .047 | 0° | 5-7/8 | 5/8 - 1 | 0.16 |
| J373 | .047 | 45° | 5-3/4 | 5/8 - 1 | 0.15 |
| J374 | .047 | 90° | 5-11/16 | 5/8 - 1 | 0.16 |
| J385 | .070 | 0° | 7-1/2 | 1-1/16 - 13/4 | 0.29 |
| J375 | .070 | 45° | 7-3/8 | 1-1/16 - 13/4 | 0.32 |
| J376 | .070 | 90° | 7-1/8 | 1-7/16 - 2 | 0.31 |
| J377 | .090 | 0° | 9-1/4 | 1-13/16 - 3 | 0.54 |
| J378 | .090 | 45° | 9 | 1-13/16 - 3 | 0.55 |
| J379 | .090 | 90° | 8-5/8 | 1-13/16 - 3 | 0.56 |
| J399L | .038 | 18° | 6 | 3/8 - 9/16 | 0.19 |
| J371L | .038 | 90° | 6 | 3/8 - 9/16 | 0.19 |
| J385L | .070 | 18° | 7-1/4 | 1-1/16 - 1-3/4 | 0.33 |
| J376L | .070 | 90° | 7-1/4 | 1-7/16 - 2 | 0.33 |

ASME B107.500

RETAINING RING PLIERS - EXTERNAL

- › Used with External Retaining Rings.
- › Fixed tips are precision formed and induction hardened for accurate fit and long wear.



| Product # | Tip Size | Tip Angle | Length (in) | Weight (lbs) |
|-------------|----------|-----------|-------------|--------------|
| J391 | .038 | 0° | 6-1/8 | 0.15 |
| J397 | .038 | 90° | 6-1/8 | 0.15 |
| J393 | .070 | 0° | 6-7/8 | 0.22 |
| J395 | .115 | 0° | 9-1/8 | 0.49 |

ASME B107.500

RETAINING RING PLIERS - INTERNAL

- › Used with Internal Retaining Rings.
- › Fixed tips are precision formed and induction hardened for accurate fit and long wear.



| Product # | Tip Size | Tip Angle | Length (in) | Bore Diameter (in) (Internal) | Weight (lbs) |
|-------------|----------|-----------|-------------|--|--------------|
| J388 | .023 | 0° | 5-1/4 | – | 0.06 |
| J390 | .025 | 0° | 5-3/8 | 1/4 - 5/16 1/4 - 5/16 1/4 - 5/16 5/8 | 0.14 |
| J389 | .038 | 0° | 5-3/8 | 3/8 - 9/16 | 0.13 |
| J398 | .038 | 45° | 5-3/8 | 3/8 - 9/16 3/8 - 9/16 3/4 - 1 | 0.13 |
| J392 | .070 | 0° | 6-1/2 | 1-1/16 - 13/4 1-1/16 - 1-3/4 1-1/16 - 1-3/4 1-7/16 - 2 | 0.19 |
| J394 | .090 | 0° | 9 | 1-13/16 - 3 1-13/16 - 3 1-13/16 - 3 2-1/16 - 3 | 0.47 |



ASME B107.500

LARGE RETAINING RING PLIERS - INTERNAL/EXTERNAL

- › Spring-loaded ratchet mechanism minimizes operator fatigue by allowing the ring to be compressed or expanded through gradual moves and then locks at the desired size without continued pressure on the handles. Heavy and large rings are safely and easily controlled.
- › Replaceable tips in 0°, 45°, and 90° make it possible to remove and install rings in most applications. (Replacements available).



| Product # | Tip Size | Tip Angle | Length (in) | Bore Diameter (in) (Internal) | Weight (lbs) | Shaft Diameter (in) (External) |
|-------------|----------|-----------|-------------|-------------------------------|--------------|--------------------------------|
| J364 | .120 | 0° | 16-1/2 | 3-1/16 - 6 | 1.95 | – |
| J365 | .120 | 0° | 16-1/2 | – | 1.98 | 3-1/2 - 6-1/2 |



ASME B107.500

Tip Angles

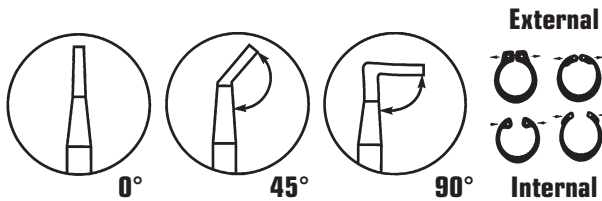

REPLACEMENT TIPS FOR J364 AND J365

| Product # | Overall Length (in) (L) | Weight (lbs) |
|-----------------|-------------------------|--------------|
| J364-T0 | 0° | 0.12 |
| J364-T45 | 45° | 0.12 |
| J364-T90 | 90° | 0.12 |



6 PIECE FACOM® 1000V VE PLIER/SCREWDRIVER SET



Product #: **FW-184.J5VE**

- › Designed for working on live components up to 1000V AC and 1500V DC.

| Contents | Description |
|----------------|--|
| FA-185.20VE | Pliers, Halfround 1000V VE 7-7/8" |
| FA-187.18VE | Pliers, Combo 1000V VE 7-1/4" |
| FA-192.16VE | Pliers, Diagonal Cutting 1000V VE 6-1/4" |
| FW-ADY.1X100VE | Screwdriver, 1000V Pozidriv® |
| FW-AY.4X100VE | Screwdriver, 1000V 4 mm Slot 7-7/8" |
| FW-AY.5.5X125V | Screwdriver, 1000V 5.5 mm Slot 8-7/8" |



FACOM® 3 PIECE VE PLIERS SET



Product #: **FW-MOD.VE**

- › 1000V insulated grips designed for electrical safety when working on or near live components.
- › Handles designed to resist workshop chemicals (Skydrol®, chlorothene, acetone, petrol).

| Contents | Description |
|-------------|--|
| FA-180.VE | Pliers, Multigrip 1000V VE 10" |
| FA-194.17VE | Pliers, Wire Stripper 1000V VE 6-1/2" |
| FA-391.16VE | Pliers, Diagonal Cutting 1000V VE 6-1/2" |



FACOM® INSULATED VE MUTIGRIP PLIERS



- › 1000V insulated grips designed for electrical safety when working on or near live components.

| Product # | Overall Size (in) | Overall | Jaw | Jaw | Weight (lbs) |
|------------------|-------------------|-----------------|-----------------|----------------|--------------|
| | | Length (in) (L) | Length (in) (A) | Width (in) (B) | |
| FA-180.VE | 10 | 10 | 1-3/16 | 7/8 | 0.78 |



FACOM® INSULATED VE HALF ROUND PLIERS



- › 1000V insulated grips designed for electrical safety when working on or near live components.
- › Side cutter for steel wire up to 14AWG.
- › Serrated jaws with central area for handling rods.

| Product # | Size (in) | Overall Length (in) (L) | Jaw Length (in) (A) | Jaw Width (in) (B) | Weight (lbs) |
|--------------------|-----------|-------------------------|---------------------|--------------------|--------------|
| FA-185.20VE | 7-7/8 | 7-7/8 | 2-15/16 | 11/32 | 0.45 |
| FA-193.16VE | 6-1/2 | 6-7/8 | 1-13/16 | 11/32 | 0.41 |



FACOM® INSULATED VE COMBINATION PLIERS



- ▶ 1000V insulated grips designed for electrical safety when working on or near live components.
- ▶ High-frequency hardened cutting edges for power and durability.
- ▶ Nose profile combines strength and maneuverability.



| Product # | Size (in) | Overall Length (in) (L) | Jaw Length (in) (A) | Jaw Width (in) (B) | Weight (lbs) |
|--------------------|-----------|-------------------------|---------------------|--------------------|--------------|
| FA-187.16VE | 6-1/2 | 6-1/2 | 1-11/32 | 3/8 | 0.43 |
| FA-187.18VE | 7-1/4 | 7-9/32 | 1-13/32 | 13/32 | 0.53 |

FACOM® INSULATED VE FLAT NOSE PLIERS



- ▶ 1000V insulated grips designed for electrical safety when working on or near live components.
- ▶ Serrated jaws for firm grip.
- ▶ Nose designed for confined spaces.



| Product # | Size (in) | Overall Length (in) (L) | Jaw Length (in) (A) | Jaw Width (in) (B) | Weight (lbs) |
|--------------------|-----------|-------------------------|---------------------|--------------------|--------------|
| FA-188.16VE | 6-1/2 | 6-11/16 | 1-13/16 | 11/32 | 0.38 |
| FA-188.20VE | 7-7/8 | 8-1/16 | 2-15/16 | 11/32 | 0.42 |

FACOM® INSULATED VE ROUND NOSE PLIERS



- ▶ 1000V insulated grips designed for electrical safety when working on or near live components.
- ▶ For shaping loops, bends or rings.
- ▶ Serrated jaws.



| Product # | Size (in) | Overall Length (in) (L) | Jaw Length (in) (A) | Jaw Width (in) (B) | Weight (lbs) |
|--------------------|-----------|-------------------------|---------------------|--------------------|--------------|
| FA-189.17VE | 6-1/2 | 6-7/8 | 1-13/16 | 11/32 | 0.37 |

FACOM® INSULATED WIRE STRIPPER PLIERS



- ▶ 1000V insulated grips designed for electrical safety when working on or near live components.
- ▶ Jaws angled at 40°.
- ▶ Cuts single and multi-cone wire up to 14 AWG.
- ▶ Serrated jaws with central area for handling rods.



| Product # | Size (in) | Overall Length (in) (L) | Jaw Length (in) (A) | Jaw Width (in) (B) | Weight (lbs) |
|--------------------|-----------|-------------------------|---------------------|--------------------|--------------|
| FA-194.17VE | 6-1/2 | 7-11/16 | 1 | 5/8 | 0.38 |



FACOM® INSULATED VE BENT NOSE PLIERS



- › 1000V insulated grips designed for electrical safety when working on or near live components.
- › Jaws angled at 40°.
- › Cuts single and multi-cone wire up to 14 AWG.
- › Serrated jaws with central area for handling rods.



| Product # | Size (in) | Overall Length (in) (L) | Jaw Length (in) (A) | Jaw Width (in) (B) | Weight (lbs) |
|--------------------|-----------|-------------------------|---------------------|--------------------|--------------|
| FA-195.16VE | 6-3/8 | 6-7/8 | 1-5/8 | 11/32 | 0.39 |
| FA-195.20VE | 7-7/8 | 7-15/32 | 2-3/4 | 11/32 | 0.43 |

FACOM® INSULATED VE END CUTTER PLIERS



- › 1000V insulated grips designed for electrical safety when working on or near live components.
- › High-frequency hardened cutting edges ensure durable cut quality for hard wire up to 12 AWG.
- › Offset pivot to help reduce manual cutting efforts required with a center pivot point.



| Product # | Size (in) | Overall Length (in) (L) | Jaw Length (in) (A) | Jaw Width (in) (B) | Weight (lbs) |
|--------------------|-----------|-------------------------|---------------------|--------------------|--------------|
| FA-190.16VE | 6-1/2 | 6-1/2 | 1/4 | 7/16 | 0.51 |

FACOM® INSULATED VE DIAGONAL PLIERS



- › 1000V insulated grips designed for electrical safety when working on or near live components.
- › High-frequency hardened cutting edges ensure durable cut quality for hard wire up to 200kg/mm.
- › Offset pivot for reduced cutting effort.



| Product # | Size (in) | Overall Length (in) (L) | Jaw Length (in) (A) | Jaw Width (in) (B) | Weight (lbs) |
|--------------------|-----------|-------------------------|---------------------|--------------------|--------------|
| FA-192.14VE | 5-3/4 | 5-23/32 | 5/8 | 3/8 | 0.36 |
| FA-192.16VE | 6-1/4 | 6-7/8 | 23/32 | 13/32 | 0.46 |
| FA-192.18VE | 7-1/8 | 7-15/32 | 25/32 | 7/16 | 0.57 |

FACOM® INSULATED VE DIAGONAL CUTTERS



- › 1000V insulated grips designed for electrical safety when working on or near live components.
- › Edges designed for clean cut in copper wire.
- › High-frequency hardened cutting edges for durable cut accuracy.
- › Snipe nose for maneuverability in control cabinets or cutting cable loom ties.



| Product # | Size (in) | Overall Length (in) (L) | Jaw Length (in) (A) | Jaw Width (in) (B) | Weight (lbs) |
|--------------------|-----------|-------------------------|---------------------|--------------------|--------------|
| FA-391.16VE | 6-1/2 | 6-11/16 | 3/4 | 13/32 | 0.46 |



FACOM® INSULATED VSE MULTIGRIP PLIERS



- › 1000V insulated grips designed for electrical safety when working on or near live components.
- › 2 color warning handle insulation - color changes from orange to yellow if insulation integrity compromised.



| Product # | Size (in) | Overall Length (in) (L) | Jaw Length (in) (A) | Jaw Width (in) (B) | Weight (lbs) |
|-------------------|-----------|-------------------------|---------------------|--------------------|--------------|
| FA-180.VSE | 10 | 10-1/32 | 1-9/16 | 1-3/8 | 0.81 |

FACOM® INSULATED VSE HALF ROUND PLIERS



- › 2 Color warning handle insulation - color changes from orange to yellow if insulation integrity compromised.
- › Insulated to 1000V AC or 1500 DC.
- › Integrated wire-cutter.
- › Burnished nose.



| Product # | Size (in) | Overall Length (in) (L) | Jaw Length (in) (A) | Jaw Width (in) (B) | Weight (lbs) |
|----------------------|-----------|-------------------------|---------------------|--------------------|--------------|
| FA-185.20AVSE | 7-7/8 | 8-9/32 | 2-23/32 | 1-3/8 | 0.53 |
| FA-193.16AVSE | 6-1/2 | 6-7/8 | 1-31/32 | 1-1/4 | 0.37 |

FACOM® INSULATED VSE COMBINATION PLIERS



- › 2 color warning handle insulation - color changes from orange to yellow if insulation integrity compromised.
- › Insulated to 1000V AC or 1500 DC.
- › Hardened throughout for overall strength.
- › Cutting edges locally heat-treated to exceed 60 HRC hardness.
- › Burnished nose.
- › Serrated Jaw.



| Product # | Size (in) | Overall Length (in) (L) | Jaw Length (in) (A) | Jaw Width (in) (B) | Weight (lbs) |
|----------------------|-----------|-------------------------|---------------------|--------------------|--------------|
| FA-187.16AVSE | 6-1/2 | 6-1/2 | 1-11/32 | 1-3/8 | 0.44 |
| FA-187.18AVSE | 7-1/4 | 7-3/32 | 1-3/8 | 1-3/8 | 0.54 |
| FA-187.20AVSE | 8 | 7-9/32 | 1-43/64 | 1-3/8 | 0.69 |

FACOM® INSULATED VSE FLAT NOSE PLIERS



- › 2 color warning handle insulation - color changes from orange to yellow if insulation integrity compromised.
- › Insulated to 1000V AC or 1500 DC.
- › Serrated jaws for firm grip.
- › Burnished nose.



| Product # | Size (in) | Overall Length (in) (L) | Jaw Length (in) (A) | Jaw Width (in) (B) | Weight (lbs) |
|----------------------|-----------|-------------------------|---------------------|--------------------|--------------|
| FA-188.16AVSE | 6-1/2 | 6-11/16 | 1-31/32 | 1-15/32 | 0.37 |

FACOM® INSULATED VSE ROUND NOSE PLIERS



- › 2 color warning handle insulation - color changes from orange to yellow if insulation integrity compromised.
- › Insulated to 1000V AC or 1500 DC.
- › Long nipe nose, serrated for shaping bends or terminals on all types of wire.
- › Burnished nose.



| Product # | Size (in) | Overall Length (in) (L) | Jaw Length (in) (A) | Jaw Width (in) (B) | Weight (lbs) |
|---------------|-----------|-------------------------|---------------------|--------------------|--------------|
| FA-189.17AVSE | 6-1/2 | 6-7/8 | 1-25/32 | 1-5/16 | 0.36 |

FACOM® INSULATED VSE WIRE STRIPPER



- › 2 color warning handle insulation - color changes from orange to yellow if insulation integrity compromised.
- › Strips any wire in all common electrical systems, up to 10 AWG.
- › Burnished nose.
- › Knob for presetting the cutting depth.



| Product # | Size (in) | Overall Length (in) (L) | Jaw Length (in) (A) | Jaw Width (in) (B) | Weight (lbs) |
|---------------|-----------|-------------------------|---------------------|--------------------|--------------|
| FA-194.17AVSE | 6-1/2 | 6-7/8 | 7/8 | 5/16 | 0.45 |

FACOM® INSULATED VSE BENT NOSE PLIERS



- › 1000V insulated grips designed for electrical safety when working on or near live components.
- › Integral wire-cutter.
- › 2 color warning handle insulation - color changes from orange to yellow if insulation integrity compromised.
- › Burnished nose.



| Product # | Size (in) | Overall Length (in) (L) | Jaw Length (in) (A) | Jaw Width (in) (B) | Weight (lbs) |
|---------------|-----------|-------------------------|---------------------|--------------------|--------------|
| FA-195.20AVSE | 7-7/8 | 7-15/32 | 2-17/32 | 1-1/4 | 0.43 |

FACOM® INSULATED VSE CABLE CUTTERS



- › 2 color warning handle insulation - color changes from orange to yellow if insulation integrity compromised.
- › High performance compact tool.
- › Forged safety stops.
- › Burnished nose.



| Product # | Size (in) | Overall Length (in) (L) | Jaw Length (in) (A) | Jaw Width (in) (B) | Weight (lbs) |
|----------------|-----------|-------------------------|---------------------|--------------------|--------------|
| FA-412.10AVSE | 7-1/2 | 7-7/8 | 3-1/3 | 1-3/8 | 0.91 |
| FA-412.14AVSE | 9 | 9 | 1-3/16 | 1-3/8 | 1.12 |
| FA-412.150AVSE | 17-3/4 | 18-1/2 | 2-23/64 | 1-3/4 | 4.71 |



FACOM® INSULATED VSE RATCHETING CABLE CUTTERS



- › One-hand operation.
- › No cable core distortion.
- › Forged and hardened steel blade.
- › 2 color warning handle insulation - color changes from orange to yellow if insulation integrity compromised.



| Product # | Size (in) | Overall Length (in) (L) | Jaw Width (in) (B) | Weight (lbs) |
|---------------|-----------|-------------------------|--------------------|--------------|
| FA-414.45AVSE | 1-3/4 | 12 | 5-5/16 | 2.19 |
| FA-414.52AVSE | 2 | 13-3/16 | 5-1/2 | 2.26 |

FACOM® INSULATED VSE END CUTTER PLIERS



- › 2 color warning handle insulation - color changes from orange to yellow if insulation integrity compromised.
- › Cutting edges heat-treated to exceed 60 HRC.
- › Burnished nose.



| Product # | Size (in) | Overall Length (in) (L) | Jaw Length (in) (A) | Jaw Width (in) (B) | Weight (lbs) |
|---------------|-----------|-------------------------|---------------------|--------------------|--------------|
| FA-190.16AVSE | 6-1/2 | 6-11/16 | 1/4 | 1-3/8 | 0.56 |

FACOM® INSULATED VSE DIAGONAL PLIERS



- › 2 color warning handle insulation - color changes from orange to yellow if insulation integrity compromised.
- › Cutting edges heat-treated to exceed 60 HRC.
- › Burnished nose.



| Product # | Size (in) | Overall Length (in) (L) | Jaw Length (in) (A) | Jaw Width (in) (B) | Weight (lbs) |
|---------------|-----------|-------------------------|---------------------|--------------------|--------------|
| FA-192.14AVSE | 5-3/4 | 6-3/32 | 5/8 | 1-3/16 | 0.48 |
| FA-192.16AVSE | 6-1/2 | 6-1/2 | 23/32 | 13/32 | 0.54 |
| FA-192.18AVSE | 7-1/4 | 7-9/32 | 25/32 | 7/16 | 0.60 |

FACOM® INSULATED VSE DIAGONAL CUTTERS



- › 2 color warning handle insulation - color changes from orange to yellow if insulation integrity compromised.
- › Inset joint.
- › Burnished nose.



| Product # | Size (in) | Overall Length (in) (L) | Jaw Length (in) (A) | Jaw Width (in) (B) | Weight (lbs) |
|---------------|-----------|-------------------------|---------------------|--------------------|--------------|
| FA-391.16AVSE | 6-1/2 | 6-5/16 | 3/4 | 13/32 | 0.47 |

C-CLAMPS - HEAVY SERVICE STANDARD SCREW

- › Designed for heavy service applications where the strength of the extra heavy service C-clamp is not required.
- › Clamps have a high-strength steel frame with a hardened forcing screw.
- › Forcing screws are fitted with impact resistant pads.



| Product # | Opening Range (in) (C) | Throat Depth (in) (T) | Thread Diameter (in) (D) | Minimum Test Load (lbs) | Weight (lbs) |
|---------------|------------------------|-----------------------|--------------------------|-------------------------|--------------|
| J102GS | 0 - 2 | 1-3/8 | 1/2 | 7500 | 1.30 |
| J103GS | 0 - 3 | 1-3/4 | 5/8 | 8750 | 2.60 |
| J104GS | 0 - 4-1/8 | 2 | 3/4 | 10000 | 4.10 |
| J106GS | 2 - 6 | 2-1/4 | 3/4 | 11250 | 5.90 |
| J108GS | 4 - 8 | 2-1/4 | 3/4 | 12500 | 6.90 |
| J110GS | 6 - 10-1/4 | 2-3/8 | 3/4 | 13750 | 8.00 |
| J112GS | 8 - 12 | 2-5/8 | 7/8 | 15000 | 11.6 |
| J115GS | 10 - 15 | 2-5/8 | 7/8 | 16250 | 15.0 |
| J118GS | 12 - 18 | 2-7/8 | 7/8 | 17500 | 18.2 |



C-CLAMPS - STANDARD SERVICE DEEP THROAT FULL LENGTH SCREW

- › Standard service, deep throat style is the most versatile and popular.
- › Hot forged for strength and hard use.
- › Forcing screw has heavy rolled Acme thread allowing the screw to turn easily under pressure and is less susceptible to damage.
- › Forcing screw has a sliding T-handle and an impact resistant pad.



| Product # | Opening Range (in) (C) | Throat Depth (in) (T) | Thread Diameter (in) (D) | Minimum Test Load (lbs) | Weight (lbs) |
|-------------|------------------------|-----------------------|--------------------------|-------------------------|--------------|
| J402 | 0 - 2 | 2 | 1/2 | 3500 | 1.30 |
| J403 | 0 - 3 | 2-3/8 | 1/2 | 3500 | 2.00 |
| J404 | 0 - 4 | 2-3/4 | 3/4 | 6500 | 3.50 |
| J406 | 0 - 6 | 3-5/8 | 3/4 | 6600 | 5.00 |
| J408 | 0 - 8 | 4-1/2 | 3/4 | 6900 | 7.00 |
| J410 | 0 - 10 | 5-3/8 | 3/4 | 8000 | 10.5 |
| J412 | 0 - 12 | 5-3/4 | 7/8 | 9500 | 15.5 |

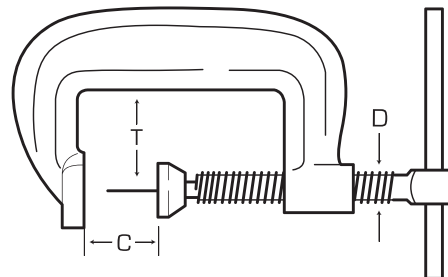



C-CLAMPS - STANDARD SERVICE DEEP THROAT SPATTER RESISTANT FULL LENGTH SCREW

- › Forcing screw and pad are plated with copper to resist welding spatter.
- › Hot forged for strength and hard use.
- › Forcing screw has heavy rolled Acme thread allowing the screw to turn easily under pressure and is less susceptible to damage.
- › Forcing screw has a sliding T-handle and an impact resistant pad.

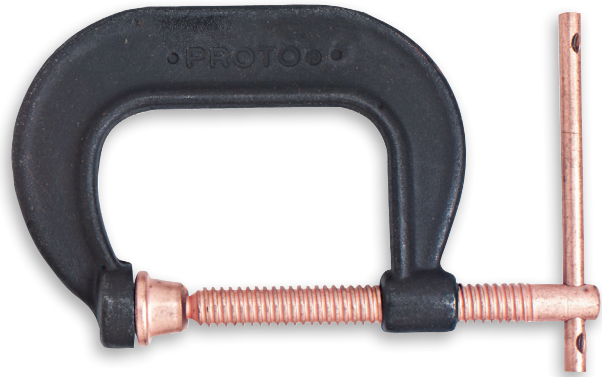

| Product # | Opening Range (in) (C) | Throat Depth (in) (T) | Thread Diameter (in) (D) | Minimum Test Load (lbs) | Weight (lbs) |
|--------------|------------------------|-----------------------|--------------------------|-------------------------|--------------|
| J402S | 0-2 | 2 | 1/2 | 3300 | 1.30 |
| J403S | 0-3 | 2-3/8 | 1/2 | 3500 | 2.00 |
| J404S | 0-4 | 2-3/4 | 3/4 | 4100 | 3.50 |
| J406S | 0-6 | 3-5/8 | 3/4 | 5400 | 5.00 |
| J408S | 0-8 | 4-1/2 | 3/4 | 5900 | 7.00 |
| J410S | 0-10 | 5-3/8 | 3/4 | 6200 | 10.5 |
| J412S | 0-12 | 5-3/4 | 7/8 | 9300 | 15.5 |



C-CLAMPS - STANDARD SERVICE EXTRA DEEP THROAT FULL LENGTH SCREW

- › Up to 32% more throat depth than standard deep throat clamps.
- › Hot forged for strength and hard use.
- › Forcing screw has heavy rolled Acme thread.
- › Full length forcing screw.



| Product # | Opening Range (in) (C) | Throat Depth (in) (T) | Thread Diameter (in) (D) | Minimum Test Load (lbs) | Weight (lbs) |
|-------------|------------------------|-----------------------|--------------------------|-------------------------|--------------|
| J424 | 0 - 4 | 3-5/8 | 3/4 | 4100 | 4.80 |
| J426 | 0 - 6 | 4-3/4 | 3/4 | 5400 | 7.00 |
| J428 | 0 - 8 | 5-5/8 | 3/4 | 5900 | 9.80 |



C-CLAMPS - STANDARD SERVICE EXTRA DEEP THROAT SPATTER RESISTANT FULL LENGTH SCREW

- › Forcing screw and pad are plated with copper to resist welding spatter.
- › Up to 32% more throat depth than standard deep throat clamps.
- › Hot forged for strength and hard use.
- › Forcing screw has heavy rolled Acme thread.
- › Full length forcing screw.

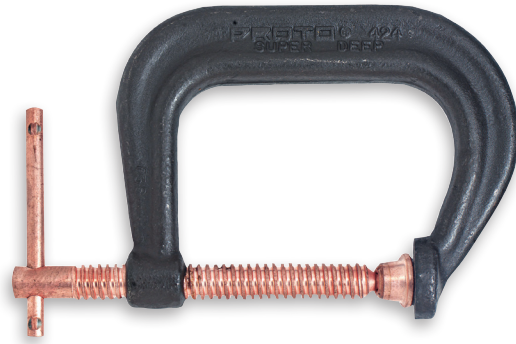

| Product # | Opening Range (in) (C) | Throat Depth (in) (T) | Thread Diameter (in) (D) | Minimum Test Load (lbs) | Weight (lbs) |
|--------------|------------------------|-----------------------|--------------------------|-------------------------|--------------|
| J424S | 0 - 4 | 3-5/8 | 3/4 | 4100 | 4.80 |
| J426S | 0 - 6 | 4-3/4 | 3/4 | 5400 | 7.00 |
| J428S | 0 - 8 | 5-5/8 | 3/4 | 5900 | 9.80 |

C-CLAMPS - EXTRA HEAVY SERVICE STANDARD SCREW

- › Strongest C-clamp design.
- › Heavy-duty threaded hub provides maximum screw support.
- › Forcing screws have a square head to be turned with a wrench.
- › Forcing screws have a hardened tip.



| Product # | Opening Range (in) (C) | Throat Depth (in) (T) | Thread Diameter (in) (D) | Minimum Test Load (lbs) | Weight (lbs) |
|-----------------|------------------------|-----------------------|--------------------------|-------------------------|--------------|
| J0-HD | 0 - 13/16 | 11/16 | 3/8 | 2800 | 0.30 |
| J1-HD | 0 - 7/16 | 1-3/32 | 7/16 | 5600 | 1.00 |
| J11/2-HD | 0 - 1-3/4 | 1-7/16 | 5/8 | 8750 | 1.90 |

C-CLAMPS - EXTRA HEAVY SERVICE FULL LENGTH SCREW

- › Full length forcing screws provide greater versatility with the minimum capacity always being 0.
- › Strongest C-clamp design.
- › Heavy-duty threaded hub provides maximum screw support.
- › Forcing screws have a square head to be turned with a wrench.
- › Forcing screws have a hardened tip.



| Product # | Opening Range (in) (C) | Throat Depth (in) (T) | Thread Diameter (in) | Minimum Test Load (lbs) | Weight (lbs) |
|----------------|------------------------|-----------------------|----------------------|-------------------------|--------------|
| J2-HDL | 0 - 2-3/8 | 1-7/8 | 3/4 | 12500 | 4.50 |
| J3-HDL | 0 - 3-5/16 | 2-5/16 | 7/8 | 16250 | 7.10 |
| J4-HDL | 0 - 4-5/8 | 2-3/4 | 1 | 20000 | 11.0 |
| J5-HDL | 0 - 5-3/8 | 3-1/16 | 1 | 23800 | 14.9 |
| J6-HDL | 0 - 6-5/8 | 3-3/8 | 1-1/8 | 27500 | 19.3 |
| J8-HDL | 0 - 8-1/4 | 3-5/8 | 1-1/4 | 31250 | 27.5 |
| J10-HDL | 0 - 10-3/8 | 3-15/16 | 1-1/4 | 35000 | 40.1 |
| J12-HDL | 0 - 12-1/2 | 4-1/4 | 1-1/4 | 40000 | 47.8 |

C-CLAMP FORCING SCREWS

| Product # | Thread Diameter (in) | Weight (lbs) |
|------------|----------------------|--------------|
| J1P1-HD | 11/25 | 0.10 |
| J2P2-HD | 3/4 | 0.53 |
| J3P2-HD | 7/8 | 0.99 |
| J4P2-HD | 1 | 1.69 |
| J5P2-HD | 1 | 1.94 |
| J6P2-HD | 1-1/8 | 2.67 |
| J10P2-HD | 1-1/4 | 4.58 |
| J11/2P1-HD | 5/8 | 0.30 |
| J12P2-HD | 1-1/4 | 5.12 |



FORGED EYE BOLTS

- › Maximum load ratings for eye bolts are drastically reduced when loading at an angle.
- › Angular loads should be avoided whenever possible.
- › For angular loads of 15° or more, consult B18.15.
- › Certified mercury free.



| Product # | Thread Size (in) (A) | Shank Length (in) (B) | Eye ID (in) (C) | OD (in) (D) | Overall Length (in) (E) | Center Eye to Shoulder (in) (F) | Rated Capacity (lbs) | Weight (lbs) |
|-----------|----------------------|-----------------------|-----------------|-------------|-------------------------|---------------------------------|----------------------|--------------|
| J94020 | 1/4 - 20 | 1.00 | .69 - .81 | 1.19 | 2.22 - 2.53 | .69 - .81 | 500 | 0.05 |
| J94021 | 5/16 - 18 | 1.12 | .81 - .94 | 1.44 | 2.66 - 2.97 | .88 - 1.00 | 900 | 0.10 |
| J94022 | 3/8 - 16 | 1.25 | .94 - 1.06 | 1.69 | 3.09 - 3.47 | 1.06 - 1.09 | 1,300 | 0.16 |
| J94023 | 7/16 - 14 | 1.38 | 1.00 - 1.12 | 1.81 | 3.41 - 3.78 | 1.19 - 1.31 | 1,800 | 0.24 |
| J94024 | 1/2 - 13 | 1.50 | 1.12 - 1.25 | 2.12 | 3.81 - 4.19 | 1.31 - 1.44 | 2,400 | 0.35 |
| J94025 | 9/16 - 12 | 1.75 | 1.31 - 1.44 | 2.56 | 4.56 - 4.94 | 1.59 - 1.72 | 3,200 | 0.47 |
| J94026 | 5/8 - 11 | 1.75 | 1.31 - 1.44 | 2.56 | 4.56 - 4.94 | 1.59 - 1.72 | 4,000 | 1.00 |
| J94027 | 3/4 - 10 | 2.00 | 1.44 - 1.56 | 2.81 | 5.0 - 5.50 | 1.72 - 1.91 | 5,000 | 1.00 |
| J94028 | 7/8 - 9 | 2.25 | 1.56 - 1.69 | 3.19 | 5.75 - 6.19 | 2.03 - 2.22 | 7,000 | 1.63 |
| J94029 | 1 - 8 | 2.50 | 1.69 - 1.81 | 3.56 | 6.44 - 6.88 | 2.22 - 2.41 | 9,000 | 2.22 |
| J94030 | 1-1/8 - 7 | 2.75 | 1.94 - 2.06 | 4.06 | 7.31 - 7.75 | 2.59 - 2.78 | 12,000 | 3.40 |
| J94031 | 1-1/4 - 7 | 3.00 | 2.12 - 2.25 | 4.44 | 8.00 - 8.44 | 3.03 - 2.84 | 15,000 | 4.44 |
| J94032 | 1-1/2 - 6 | 3.50 | 2.44 - 2.56 | 5.19 | 9.22 - 9.72 | 3.19 - 3.44 | 21,000 | 7.36 |
| J94033 | 1-3/4 - 5 | 3.75 | 2.75 - 3.00 | 6.00 | 10.50 - 11.12 | 3.88 - 4.12 | 28,000 | 11.35 |
| J94034 | 2 - 4-1/2 | 4.00 | 3.06 - 3.44 | 6.88 | 11.53 - 12.22 | 4.25 - 4.50 | 38,000 | 16.70 |

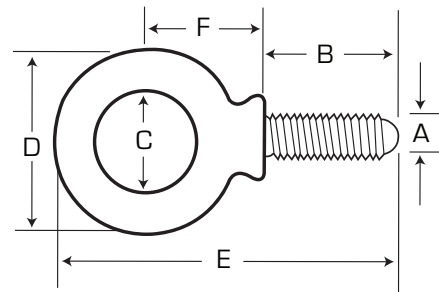
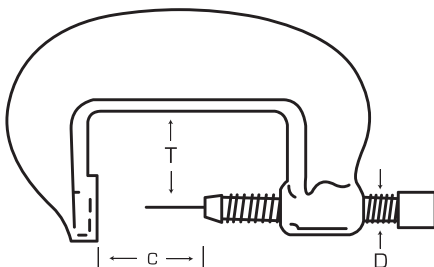

AVIATION SNIPS

- › Available in straight, left, or right models.
- › Compound leverage multiplies handle pressure and increases control for intricate cutting.
- › Serrated blades for maximum grip of the material being cut.
- › Color coded vinyl grips.

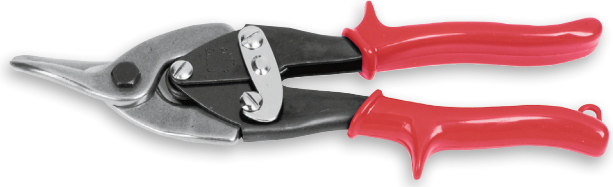

| Product # | Cuts | Handle Color | Blade Length (in) | Overall Length (in) (L) | Weight (lbs) |
|--------------|----------|--------------|-------------------|-------------------------|--------------|
| J303L | Left | Red | 1-3/8 | 10 | 0.94 |
| J303R | Right | Green | 1-3/8 | 10 | 0.94 |
| J303S | Straight | Yellow | 1-3/8 | 10 | 0.94 |

ASME B107.500

CIRCULAR CUTTING DUCKBILL SNIPS

- › Duckbill snips are designed for circle and odd shaped radius cutting.
- › Plastisol grips for added comfort.



| Product # | Blade Length (in) | Overall Length (in) (L) | Weight (lbs) |
|-------------|-------------------|-------------------------|--------------|
| J307 | 1-1/2 | 7 | 0.45 |
| J310 | 2 | 10 | 0.95 |
| J312 | 2-3/4 | 12-3/4 | 1.61 |

ASME B107.500

HEAVY-DUTY SNIPS

- › Designed for making straight and moderately irregular cuts.
- › Plastisol grips for added comfort.
- › J334 cuts up to 18 gauge CR steel and 22 gauge SS.



| Product # | Description | Blade Length (in) | Overall Length (in) (L) | Weight (lbs) |
|-------------|----------------------|-------------------|-------------------------|--------------|
| J334 | Combination Snips | 3-7/8 | 14 | 3.02 |
| J336 | Bulldog Tinner Snips | 2-1/2 | 16 | 3.63 |

ASME B107.500

AVIATION SNIPS - OFFSET

- › Available in left or right models.
- › Compound leverage multiplies handle pressure and increases control.
- › Offset handle keeps hands above working area for cutting ease and comfort.
- › Serrated blades for maximum grip of the material being cut.

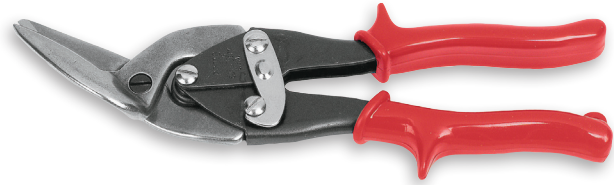

| Product # | Cuts | Handle Color | Blade Length (in) | Overall Length (in) (L) | Weight (lbs) |
|---------------|-------|--------------|-------------------|-------------------------|--------------|
| J303LS | Left | Red | 1-1/4 | 10 | 1.00 |
| J303RS | Right | Green | 1-1/4 | 10 | 1.00 |



ASME B107.500

STRAIGHT CUTTING SNIPS

- › Designed for all straight cutting including inside and outside corners.
- › Plastisol grips for added comfort.

| Product # | Blade Length (in) | Overall Length (in) (L) | Weight (lbs) |
|-------------|-------------------|-------------------------|--------------|
| J317 | 1-1/2 | 7 | 0.48 |
| J320 | 2 | 10 | 0.93 |
| J322 | 2-3/4 | 12-3/4 | 1.64 |



MINIATURE SNIPS

- › Improved shearing action.
- › Increased length of cut from 1-1/8" to 2".
- › Increased jaw opening.
- › Serrated bottom blade to grip material.
- › Ergonomic handle design.
- › Cuts up to 26 gauge cold-roll sheet metal.
- › Copper wire up to 18 AWG.
- › Soft steel wire up to 22 AWG.

| Product # | Blade Length (in) | Overall Length (in) (L) | Weight (lbs) |
|-------------|-------------------|-------------------------|--------------|
| J308 | 1-1/8 | 6-1/2 | 0.325 |



MULTI-PURPOSE TOOL - NEEDLE-NOSE

- › 15 functions including pliers with wire cutter, cross cut saw, taper grind blade, sheepfoot blade, can and bottle opener, ruler, and screwdriver bits provide versatility.
- › Locking handle securely positions and safely locks each blade or implement for safety.
- › Stainless steel construction for heavy-duty use and long life.
- › Nylon belt pouch for convenient storage.
- › Wide handle design for added comfort.



| Product # | Overall Length (in) | Weight (lbs) |
|---------------|---------------------|--------------|
| J18576 | 6 | 0.65 |



MULTI-PURPOSE TOOL - BLUNT NOSE

- › 15 functions including pliers with wire cutter, cross cut saw, taper grind blade, sheepfoot blade, can and bottle opener, ruler, and screwdriver bits provide versatility.
- › Locking handle securely positions and safely locks each blade or implement for safety.
- › Stainless steel construction for heavy-duty use and long life.
- › Nylon belt pouch for convenient storage.
- › Wide handle design for added comfort.



| Product # | Overall Length (in) | Weight (lbs) |
|---------------|---------------------|--------------|
| J18575 | 5-5/8 | 0.56 |



LOCKBACK KNIVES

- › 420 grade high carbon stainless steel blade.
- › Hardwood handle with heavy-duty lock springs.
- › Solid one piece brass bolster and liner provide additional strength.
- › Blade locks in open position to guard against accidental closing.
- › J18545 includes a leather sheath.



| Product # | Blade Length (in) | Closed Position Length (in) | Open Position Length (in) | Weight (lbs) |
|----------------|-------------------|-----------------------------|---------------------------|--------------|
| J18543 | 2-1/4 | 3 | 5-1/4 | 0.16 |
| J18545 | 3-3/4 | 4-7/8 | 8-3/4 | 0.57 |
| J18545B | 3-3/4 | 4-7/8 | 8-3/4 | 0.57 |



COMMEMORATIVE LOCKBACK KNIFE

- › Commemorative sculpted brass handle.
- › Unique artwork features the Proto® logo on one side, a selection of Proto® tools on the reverse side.



| Product # | Blade Length (in) | Closed Position Length (in) | Open Position Length (in) | Weight (lbs) |
|---------------|-------------------|-----------------------------|---------------------------|--------------|
| J18510 | 2 | 3 | 5-1/4 | 0.16 |



FACOM® VSE SERIES INSULATED KNIFE



- › For working on live components up to 1000V AC and 1500V DC.
- › Thick, angled blade with flat tip.
- › Cushion handle.
- › Blade sheath.
- › Effective blade length 2".



| Product # | Blade Length (in) | Overall Length (in) | Weight (lbs) |
|---------------------|-------------------|---------------------|--------------|
| FT-1820.AVSE | 2-3/8 | 7-1/2 | 0.19 |

ELECTRICIAN'S KNIFE WITH STRIPPING BLADE

- › Spear blade.
- › Stripping blade.
- › Self-locking combination screwdriver, insulation cutter and wire scraper blade.



| Product # | Blade Length (in) | Closed Position Length (in) | Open Position Length (in) | Weight (lbs) |
|---------------|-------------------|-----------------------------|---------------------------|--------------|
| J18535 | 3 | 3-3/4 | 7 | 0.32 |

ELECTRICIAN'S KNIFE

- › Spear blade.
- › Self-locking combination screwdriver, insulation cutter and wire scraper blade.



| Product # | Blade Length (in) | Closed Position Length (in) | Open Position Length (in) | Weight (lbs) |
|---------------|-------------------|-----------------------------|---------------------------|--------------|
| J18500 | 3 | 3-3/4 | 7 | 0.24 |

PRUNING KNIFE

- › Curved blade for precision cutting and stripping.



| Product # | Blade Length (in) | Closed Position Length (in) | Open Position Length (in) | Weight (lbs) |
|---------------|-------------------|-----------------------------|---------------------------|--------------|
| J18505 | 4 | 4-3/4 | 9 | 0.26 |

FACOM® VSE SERIES INSULATED HACKSAW



- › Two blade positions.
- › Butterfly tension nut.
- › Supplied with bi-metal blade.
- › 12" blade replacement.



| Product # | Blade Length (in) | Overall Length (in) | Weight (lbs) |
|--------------------|-------------------|---------------------|--------------|
| FT-602.AVSE | 12 | 18-1/2 | 1.30 |



BRUTE FORCE, SHAKE HANDS WITH INTELLIGENT DESIGN.

Some tools take a pounding. Literally. Proto® combats that by pairing durability with innovative design.

Our punches and chisels are hardened, quenched, tempered, and finished in black oxide. Meanwhile, their cutting edges are ground to ensure the best and easiest cut through the toughest metals.

Our ball pein hammers feature hardened, drop-forged heads with rim-tempered faces to resist chipping.

Meanwhile, their handles prevent slipping and absorb the shock your forearm would otherwise.

And naturally, our lines offer a variety of striking and struck tools to suit any task. So you can pound, chisel, cut and pry to your heart's content.

STRIKING AND STRUCK TOOLS



Dead Blow Compo-Cast® Combo Face Hammers

PROTO

DEAD BLOW COMPO-CAST® COMBO FACE HAMMERS

- › Top welded handle-to-head assembly adds extra durability and safety.
- › Hot urethane Uni-Cast construction outlasts all other soft face striking tools. Urethane composition provides shape-retaining faces even after repeated striking on hard surfaces and sharp edges.
- › Handle is reinforced with solid steel shaft for greater strength safety.
- › Top of head molded with a flat surface.
- › Dual head design (Standard Dead Blow and Slim-line heads).
- › Comfortable dual molded grip.

CHISELS

(30) different types and sizes of chisels



PUNCHES

(60) different sizes and types of pins and punches

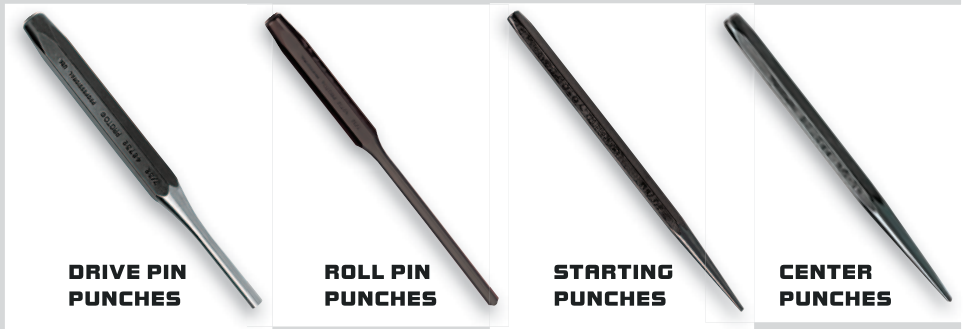

BARs

(10) different sizes and types of bars



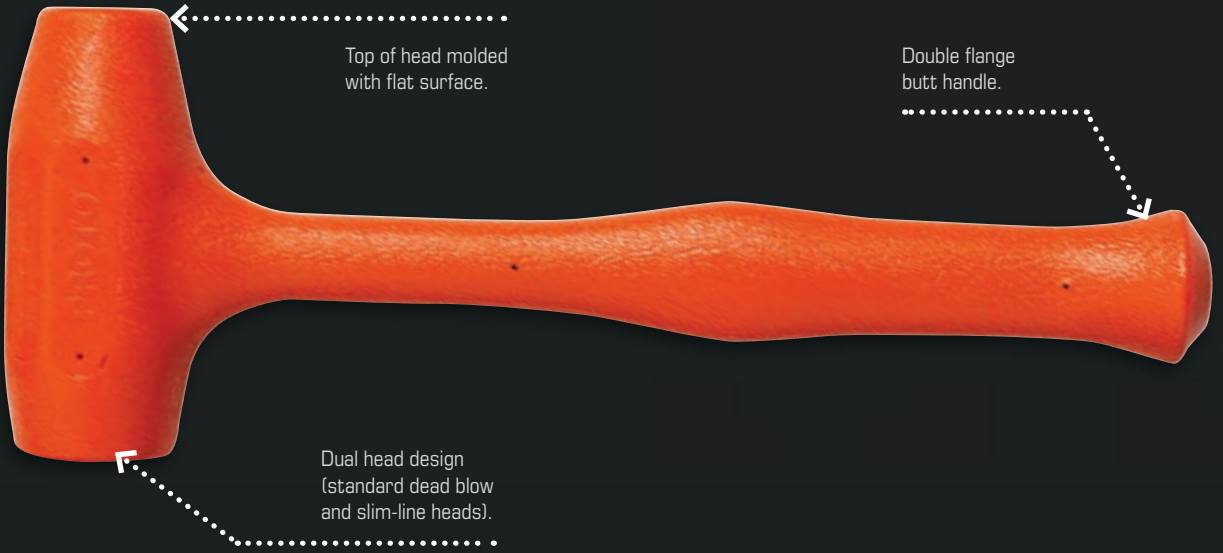

Top of head molded with flat surface.

Double flange butt handle.

Dual head design (standard dead blow and slim-line heads).

HAMMER GUIDE

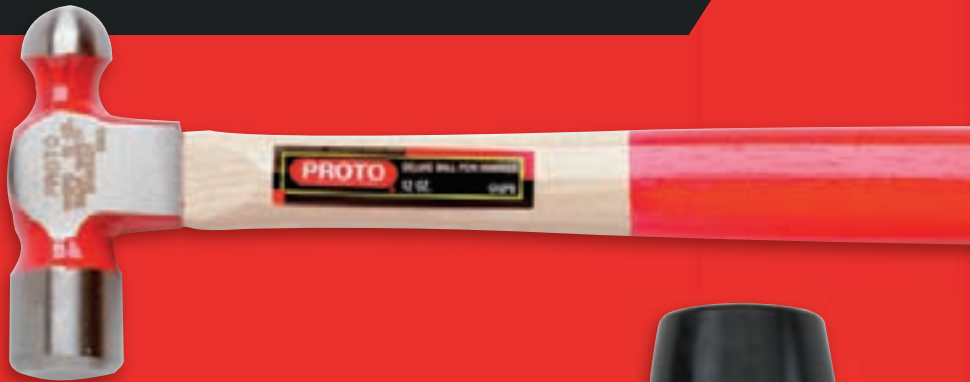

BALL PEIN HAMMERS



RUBBER MALLET



BRASS HAMMERS



TWO-WAY HAMMERS



CROSS PEIN HAMMERS



SOFT FACE HAMMERS

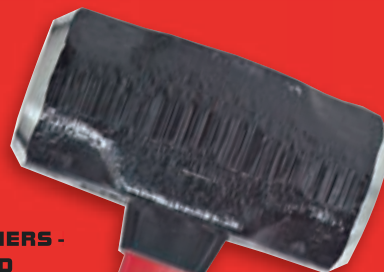

SLEDGE HAMMERS - DOUBLE FACED

12 PIECE PUNCH AND CHISEL SET

Product #: **J2S2**



- › Made from S2 steel and specially heat-treated for greater strength and durability.
- › Modified parabolic striking end to help reduce mushrooming and chipping.
- › Black oxide finish to help prevent rust corrosion; extending tool life and performance.
- › A polished identification panel on one of the flats is marked with the tool number and size in a black inlay.
- › Set offers a wide range of sizes to handle a variety jobs.
- › Includes a pouch for convenient storage solution.
- › Weight (lbs): 1.80



| Contents | Description | Tip Width (in) (A) | Shank Width (in) (B) | Overall Length (in) (L) | ASME Spec. |
|-------------|----------------------------|--------------------|----------------------|-------------------------|---------------|
| J725/16S2 | 7/32" Cape Chisel | 5/16 | 5/16 | 5-1/8 | ASME B107.410 |
| J765/16S2 | 3/16" Diamond Point Chisel | 3/16 | 5/16 | 5 | ASME B107.410 |
| J86A1/4S2 | 5/16" Cold Chisel | 5/16 | 1/4 | 5-1/8 | ASME B107.410 |
| J86A3/8S2 | 7/16" Cold Chisel | 7/16 | 3/8 | 5-9/16 | ASME B107.410 |
| J86A7/16S2 | 1/2" Cold Chisel | 1/2 | 7/16 | 6 | ASME B107.410 |
| J413/8S2 | 3/8" Center Punch | – | 3/8 | 4-7/8 | ASME B107.410 |
| J471/4X3/32 | 3/32" Pin Punch | 3/32 | 1/4 | 4-3/4 | ASME B107.410 |
| J473/8X3/16 | 3/16" Pin Punch | 3/16 | 3/8 | 5-7/8 | ASME B107.410 |
| J475/16X1/8 | 1/8" Pin Punch | 1/8 | 5/16 | 5-3/16 | ASME B107.410 |
| J503/16S2 | 1/16" Starting Punch | 1/16 | 1/4 | 4-1/8 | ASME B107.410 |
| J503/8S2 | 3/16" Starting Punch | 3/16 | 3/8 | 5-5/8 | ASME B107.410 |
| J505/16S2 | 1/8" Starting Punch | 1/8 | 5/16 | 5-1/8 | ASME B107.410 |
| J25TR02C | Pouch | | | | |

5 PIECE PUNCH AND CHISEL SET

Product #: **J3S2**



- › Made from S2 steel and specially heat-treated for greater strength and durability.
- › Modified parabolic striking end to help reduce mushrooming and chipping.
- › Black oxide finish to help prevent rust corrosion; extending tool life and performance.
- › A polished identification panel on one of the flats is marked with the tool number and size in a black inlay.
- › Set offers a wide range of sizes to handle a variety jobs.
- › Includes a pouch for convenient storage solution.
- › Weight (lbs): 1.04



| Contents | Description | Tip Width (in) (A) | Shank Width (in) (B) | Overall Length (in) (L) | ASME Spec. |
|-------------|---------------------|--------------------|----------------------|-------------------------|---------------|
| J86A1/2S2 | 5/8" Cold Chisel | 5/8 | 1/2 | 6-3/4 | ASME B107.410 |
| J413/8S2 | 3/8" Center Punch | 1/2 | 3/8 | 4-7/8 | ASME B107.410 |
| J473/8X3/16 | 3/16" Pin Punch | 3/16 | 3/8 | 5-7/8 | ASME B107.410 |
| J475/16X1/8 | 1/8" Pin Punch | 1/8 | 5/16 | 5-3/16 | ASME B107.410 |
| J505/16S2 | 1/8" Starting Punch | 1/8 | 5/16 | 5-1/8 | ASME B107.410 |
| J25TR15C | Pouch | | | | |

26 PIECE PUNCH AND CHISEL SET

Product #: **J46S2**

- ▶ Made from S2 steel and specially heat-treated for greater strength and durability.
- ▶ Modified parabolic striking end to help reduce mushrooming and chipping.
- ▶ Black oxide finish to help prevent rust corrosion; extending tool life and performance.
- ▶ A polished identification panel on one of the flats is marked with the tool number and size in a black inlay.
- ▶ Set offers a wide range of sizes to handle a variety jobs.
- ▶ Includes a pouch for convenient storage solution.
- ▶ Weight (lbs): 8.91



| Contents | Description | Tip Width (in) (A) | Shank Width (in) (B) | Overall Length (in) (L) | ASME Spec. |
|--------------|----------------------|--------------------|----------------------|-------------------------|---------------|
| J86A1/2S2 | 5/8" Cold Chisel | 5/8 | 1/2 | 6-3/4 | ASME B107.410 |
| J86A1/4S2 | 5/16" Cold Chisel | 5/16 | 1/4 | 5-1/8 | ASME B107.410 |
| J86A1X8S2 | 1-3/16" Cold Chisel | 1-3/16 | 1 | 8-1/4 | ASME B107.410 |
| J86A3/16S2 | 1/4" Cold Chisel | 1/4 | 3/16 | 4-7/8 | ASME B107.410 |
| J86A3/4X8S2 | 7/8" Cold Chisel | 7/8 | 3/4 | 8 | ASME B107.410 |
| J86A5/16S2 | 3/8" Cold Chisel | 3/8 | 5/16 | 5-3/8 | ASME B107.410 |
| J86A5/8S2 | 3/4" Cold Chisel | 3/4 | 5/8 | 6-7/8 | ASME B107.410 |
| J86A7/16S2 | 1/2" Cold Chisel | 1/2 | 7/16 | 6 | ASME B107.410 |
| J86A7/8X8S2 | 1" Cold Chisel | 1 | 7/8 | 8-1/2 | ASME B107.410 |
| J411/2S2 | 1/2" Center Punch | - | 1/2 | 5-5/8 | ASME B107.410 |
| J413/8S2 | 3/8" Center Punch | - | 3/8 | 4-7/8 | ASME B107.410 |
| J445/16S2 | 5/16" Prick Punch | - | 5/16 | 5 | ASME B107.410 |
| J471/2X1/4 | 1/4" Pin Punch | 1/4 | 3/8 | 6-3/4 | ASME B107.410 |
| J471/4X3/32 | 3/32" Pin Punch | 3/32 | 1/4 | 4-3/4 | ASME B107.410 |
| J473/8X3/16 | 3/16" Pin Punch | 3/16 | 3/8 | 5-7/8 | ASME B107.410 |
| J475/16X1/8 | 1/8" Pin Punch | 1/8 | 5/16 | 5-3/16 | ASME B107.410 |
| J475/16X5/32 | 5/32" Pin Punch | 5/32 | 5/16 | 5-9/16 | ASME B107.410 |
| J477/16X7/32 | 7/32" Pin Punch | 7/32 | 3/8 | 6-3/8 | ASME B107.410 |
| J501/2S2 | 1/4" Starting Punch | 1/4 | 1/2 | 6-1/2 | ASME B107.410 |
| J501/4S2 | 3/32" Starting Punch | 3/32 | 1/4 | 5 | ASME B107.410 |
| J503/8S2 | 3/16" Starting Punch | 3/16 | 3/8 | 5-5/8 | ASME B107.410 |
| J505/16S2 | 1/8" Starting Punch | 1/8 | 5/16 | 5-1/8 | ASME B107.410 |
| J507/16S2 | 7/32" Starting Punch | 7/32 | 7/16 | 6 | ASME B107.410 |
| J961/2S2 | 1/4" Drift Punch | 1/4 | 1/2 | 10 | ASME B107.410 |
| J963/8S2 | 3/16" Drift Punch | 3/16 | 3/8 | 10 | ASME B107.410 |
| J965/16S2 | 1/8" Drift Punch | 1/8 | 5/16 | 10 | ASME B107.410 |
| J25TR21C | Pouch | | | | |

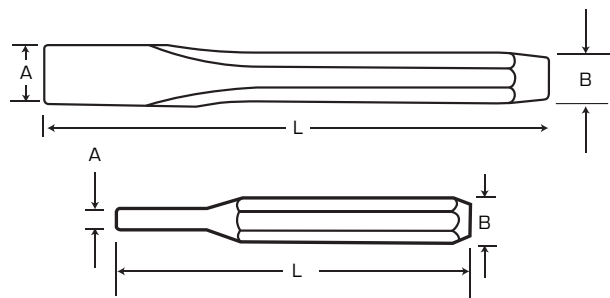

7 PIECE COLD CHISEL SET

Product #: J86BS2

- › Made from S2 steel and specially heat-treated for greater strength and durability.
- › Modified parabolic striking end to help reduce mushrooming and chipping.
- › Hand ground cutting edge to the exact angle for cutting through tough metals.
- › Black oxide finish to help prevent rust corrosion; extending tool life and performance.
- › A polished identification panel on one of the flats is marked with the tool number and size in a black inlay.
- › Set offers a wide range of sizes to handle a variety jobs.
- › Includes a pouch for convenient storage solution.
- › Weight (lbs): 2.75



| Contents | Description | Tip Width (in) (A) | Shank Width (in) (B) | Overall Length (in) (L) | ASME Spec. |
|-------------|-------------------|--------------------|----------------------|-------------------------|---------------|
| J86A1/2S2 | 5/8" Cold Chisel | 5/8 | 1/2 | 6-3/4 | ASME B107.410 |
| J86A1/4S2 | 5/16" Cold Chisel | 5/16 | 1/4 | 5-1/8 | ASME B107.410 |
| J86A3/4X8S2 | 7/8" Cold Chisel | 7/8 | 3/4 | 8 | ASME B107.410 |
| J86A3/8S2 | 7/16" Cold Chisel | 7/16 | 3/8 | 5-9/16 | ASME B107.410 |
| J86A5/16S2 | 3/8" Cold Chisel | 3/8 | 5/16 | 5-3/8 | ASME B107.410 |
| J86A5/8S2 | 3/4" Cold Chisel | 3/4 | 5/8 | 6-7/8 | ASME B107.410 |
| J86A7/16S2 | 1/2" Cold Chisel | 1/2 | 7/16 | 6 | ASME B107.410 |
| J25TR23C | Pouch | | | | |

5 PIECE COLD CHISEL SET

Product #: J86CS2

- › Made from S2 steel and specially heat-treated for greater strength and durability.
- › Modified parabolic striking end to help reduce mushrooming and chipping.
- › Hand ground cutting edge to the exact angle for cutting through tough metals.
- › Black oxide finish to help prevent rust corrosion; extending tool life and performance.
- › A polished identification panel on one of the flats is marked with the tool number and size in a black inlay.
- › Set offers a wide range of sizes to handle a variety jobs.
- › Includes a pouch for convenient storage solution.
- › Weight (lbs): 1.17



| Contents | Description | Tip Width (in) (A) | Shank Width (in) (B) | Overall Length (in) (L) | ASME Spec. |
|------------|-------------------|--------------------|----------------------|-------------------------|---------------|
| J86A1/2S2 | 5/8" Cold Chisel | 5/8 | 1/2 | 6-3/4 | ASME B107.410 |
| J86A1/4S2 | 5/16" Cold Chisel | 5/16 | 1/4 | 5-1/8 | ASME B107.410 |
| J86A3/8S2 | 7/16" Cold Chisel | 7/16 | 3/8 | 5-9/16 | ASME B107.410 |
| J86A5/16S2 | 3/8" Cold Chisel | 3/8 | 5/16 | 5-3/8 | ASME B107.410 |
| J86A7/16S2 | 1/2" Cold Chisel | 1/2 | 7/16 | 6 | ASME B107.410 |
| J25TR15C | Pouch | | | | |

5 PIECE SUPER-DUTY CHISELS SET

Product #: **J86000**

- › Made from S2 steel and specially heat-treated for greater strength and durability.
- › 20% larger striking surface than standard chisels directs the power to the cutting edge.
- › Longer shank features a knurl for better grip and easy positioning.
- › Hand ground cutting edge to the exact angle for cutting through tough metals.
- › Black oxide finish to help prevent rust corrosion; extending tool life and performance.
- › A polished identification panel on one of the flats is marked with the tool number and size in a black inlay.
- › Set offers a wide range of sizes to handle a variety jobs.
- › Includes a pouch for convenient storage solution.
- › Weight (lbs): 2.84



| Contents | Description | Tip Width (in) (A) | Shank Width (in) (B) | Overall Length (in) (L) | ASME Spec. |
|----------|-----------------------------|--------------------|----------------------|-------------------------|---------------|
| J86038 | 3/8" Super-Duty Cold Chisel | 3/8 | 5/16 | 6 | ASME B107.410 |
| J86012 | 1/2" Super-Duty Cold Chisel | 1/2 | 7/16 | 6-13/16 | ASME B107.410 |
| J86058 | 5/8" Super-Duty Cold Chisel | 5/8 | 1/2 | 7-5/8 | ASME B107.410 |
| J86034 | 3/4" Super-Duty Cold Chisel | 3/4 | 5/8 | 8-7/16 | ASME B107.410 |
| J86078 | 7/8" Super-Duty Cold Chisel | 7/8 | 3/4 | 9-1/4 | ASME B107.410 |
| J25TR06C | Pouch | | | 12 | |

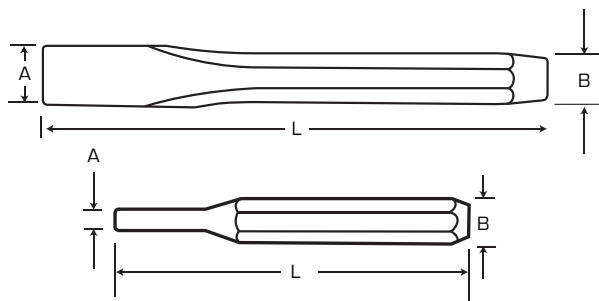

5 PIECE LONG DRIVE PIN PUNCH SET

Product #: **J48005LS2**

- › Made from S2 steel and specially heat-treated for greater strength and durability.
- › One-piece design for strength and durability.
- › Reverse taper to help prevent binding.
- › Modified parabolic striking end to help reduce mushrooming and chipping.
- › Black oxide finish to help prevent rust corrosion; extending tool life and performance.
- › A polished identification panel on one of the flats is marked with the tool number and size in a black inlay.
- › Set offers a wide range of sizes to handle a variety jobs.
- › Includes a pouch for convenient storage solution.
- › Weight (lbs): 0.90



| Contents | Description | Tip Width (in) (A) | Shank Width (in) (B) | Overall Length (in) (L) | ASME Spec. |
|-----------|---------------------------------|--------------------|----------------------|-------------------------|---------------|
| J48014LS2 | 1/4" Super-Duty Long Punch Pin | 1/4 | 1/2 | 8 | ASME B107.410 |
| J48316LS2 | 3/16" Super-Duty Long Punch Pin | 3/16 | 3/8 | 8 | ASME B107.410 |
| J48516LS2 | 5/16" Super-Duty Long Punch Pin | 5/16 | 1/2 | 8 | ASME B107.410 |
| J48532LS2 | 5/32" Super-Duty Long Punch Pin | 5/32 | 3/8 | 8 | ASME B107.410 |
| J48732LS2 | 7/32" Super-Duty Long Punch Pin | 7/32 | 7/16 | 8 | ASME B107.410 |
| J25TR30C | Pouch | | | | |

7 PIECE SUPER-DUTY PIN PUNCH SET

Product #: **J48007**

- › Made from S2 steel and specially heat-treated for greater strength and durability.
- › One-piece design for strength and durability.
- › Reverse taper to help prevent binding.
- › Modified parabolic striking end to help reduce mushrooming and chipping.
- › Black oxide finish to help prevent rust corrosion; extending tool life and performance.
- › A polished identification panel on one of the flats is marked with the tool number and size in a black inlay.
- › Set offers a wide range of sizes to handle a variety jobs.
- › Includes a pouch for convenient storage solution.
- › Weight (lbs): 0.90



| Contents | Description | Tip Width (in) (A) | Shank Width (in) (B) | Overall Length (in) (L) | ASME Spec. |
|----------|----------------------------|--------------------|----------------------|-------------------------|---------------|
| J48116 | 1/16" Super-Duty Punch Pin | 1/16 | 1/4 | 4-1/8 | ASME B107.410 |
| J48332 | 5/32" Super-Duty Punch Pin | 3/32 | 1/4 | 4-1/2 | ASME B107.410 |
| J48018 | 1/8" Super-Duty Punch Pin | 1/8 | 5/16 | 4-3/4 | ASME B107.410 |
| J48532 | 5/32" Super-Duty Punch Pin | 5/32 | 5/16 | 5 | ASME B107.410 |
| J48316 | 3/16" Super-Duty Punch Pin | 3/16 | 3/8 | 5-1/4 | ASME B107.410 |
| J48732 | 7/32" Super-Duty Punch Pin | 7/32 | 7/16 | 5-1/2 | ASME B107.410 |
| J48014 | 1/4" Super-Duty Punch Pin | 1/4 | 7/16 | 5-3/4 | ASME B107.410 |
| J25TR31C | Pouch | | | | |

7 PIECE DRIFT PUNCH SET

Product #: **J96AS2**

- › Made from S2 steel and specially heat-treated for greater strength and durability.
- › One-piece design for strength and durability.
- › Reverse taper to help prevent binding.
- › Modified parabolic striking end to help reduce mushrooming and chipping.
- › Black oxide finish to help prevent rust corrosion; extending tool life and performance.
- › A polished identification panel on one of the flats is marked with the tool number and size in a black inlay.
- › Set offers a wide range of sizes to handle a variety jobs.
- › Includes a pouch for convenient storage solution.
- › Weight (lbs): 3.46



| Contents | Description | Tip Width (in) (A) | Shank Width (in) (B) | Overall Length (in) (L) | ASME Spec. |
|-----------|-------------------|--------------------|----------------------|-------------------------|---------------|
| J961/2S2 | 1/4" Drift Punch | 1/4 | 1/2 | 10 | ASME B107.410 |
| J961/4S2 | 3/32" Drift Punch | 3/32 | 1/4 | 10 | ASME B107.410 |
| J963/4S2 | 3/8" Drift Punch | 3/8 | 3/4 | 10 | ASME B107.410 |
| J963/8S2 | 3/16" Drift Punch | 3/16 | 3/8 | 10 | ASME B107.410 |
| J965/16S2 | 1/8" Drift Punch | 1/8 | 5/16 | 10 | ASME B107.410 |
| J965/8S2 | 5/16" Drift Punch | 5/16 | 5/8 | 10 | ASME B107.410 |
| J967/16S2 | 7/32" Drift Punch | 7/32 | 7/16 | 10 | ASME B107.410 |
| J25TR29C | Pouch | | | | |

7 PIECE ROLL PIN PUNCH SET

Product #: **J49007S2**

- › Made from S2 steel and specially heat-treated for greater strength and durability.
- › One-piece design for strength and durability.
- › Reverse taper to help prevent binding.
- › Modified parabolic striking end to help reduce mushrooming and chipping.
- › Black oxide finish to help prevent rust corrosion; extending tool life and performance.
- › A polished identification panel on one of the flats is marked with the tool number and size in a black inlay.
- › Set offers a wide range of sizes to handle a variety jobs.
- › Includes a pouch for convenient storage solution.
- › Weight (lbs): 0.77



| Contents | Description | Tip Width (in) (A) | Shank Width (in) (B) | Overall Length (in) (L) |
|----------|----------------------|--------------------|----------------------|-------------------------|
| J49014S2 | 1/4" Roll Punch Pin | 1/4 | 7/16 | 6-7/16 |
| J49018S2 | 1/8" Roll Punch Pin | 1/8 | 5/16 | 4-3/4 |
| J49116S2 | 1/16" Roll Pin Punch | 1/16 | 1/4 | 3-3/4 |
| J49316S2 | 3/16" Roll Pin Punch | 3/16 | 3/8 | 5-7/16 |
| J49332S2 | 3/32" Roll Pin Punch | 3/32 | 1/4 | 4-1/4 |
| J49532S2 | 5/32" Roll Pin Punch | 5/32 | 5/16 | 5-1/4 |
| J49732S2 | 7/32" Roll Pin Punch | 7/32 | 3/8 | 5-7/8 |
| J25TR31C | Pouch | | | |

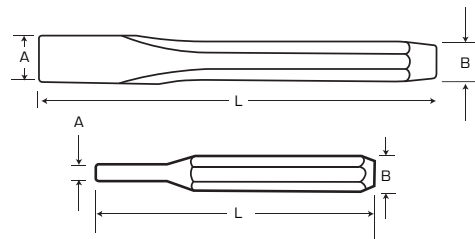

5 PIECE DRIFT PUNCH SET

Product #: **J96BS2**

- › Made from S2 steel and specially heat-treated for greater strength and durability.
- › One-piece design for strength and durability.
- › Reverse taper to help prevent binding.
- › Modified parabolic striking end to help reduce mushrooming and chipping.
- › Black oxide finish to help prevent rust corrosion; extending tool life and performance.
- › A polished identification panel on one of the flats is marked with the tool number and size in a black inlay.
- › Set offers a wide range of sizes to handle a variety jobs.
- › Includes a pouch for convenient storage solution.
- › Weight (lbs): 2.30



| Contents | Description | Tip Width (in) (A) | Shank Width (in) (B) | Overall Length (in) (L) | ASME Spec. |
|-----------|-------------------|--------------------|----------------------|-------------------------|---------------|
| J961/2S2 | 1/4" Drift Punch | 1/4 | 1/2 | 10 | ASME B107.410 |
| J963/8S2 | 3/16" Drift Punch | 3/16 | 3/8 | 10 | ASME B107.410 |
| J965/16S2 | 1/8" Drift Punch | 1/8 | 5/16 | 10 | ASME B107.410 |
| J965/8S2 | 5/16" Drift Punch | 5/16 | 5/8 | 10 | ASME B107.410 |
| J967/16S2 | 7/32" Drift Punch | 7/32 | 7/16 | 10 | ASME B107.410 |
| J25TR30C | Pouch | | | | |

7 PIECE PIN PUNCH SET

Product #: **J47A**

- › Made from S2 steel and specially heat-treated for greater strength and durability.
- › Two-piece design allows the tip to be hard for durability while allowing it to be produced straight to help prevent binding.
- › Modified parabolic striking end to help reduce mushrooming and chipping.
- › Black oxide finish to help prevent rust corrosion; extending tool life and performance.
- › A polished identification panel on one of the flats is marked with the tool number and size in a black inlay.
- › Set offers a wide range of sizes to handle a variety of jobs.
- › Includes a pouch for convenient storage solution.
- › Weight (lbs): 1.15



| Contents | Description | Tip Width (in) (A) | Shank Width (in) (B) | Overall Length (in) (L) | ASME Spec. |
|--------------|-----------------|--------------------|----------------------|-------------------------|---------------|
| J471/4X1/16 | 1/16" Punch Pin | 1/16 | 1/4 | 4-3/8 | ASME B107.410 |
| J471/4X3/32 | 3/32" Pin Punch | 3/32 | 1/4 | 4-3/4 | ASME B107.410 |
| J475/16X1/8 | 1/8" Pin Punch | 1/8 | 5/16 | 5-3/16 | ASME B107.410 |
| J475/16X5/32 | 5/32" Pin Punch | 5/32 | 5/16 | 5-9/16 | ASME B107.410 |
| J473/8X3/16 | 3/16" Pin Punch | 3/16 | 3/8 | 5-7/8 | ASME B107.410 |
| J477/16X7/32 | 7/32" Pin Punch | 7/32 | 3/8 | 6-3/8 | ASME B107.410 |
| J471/2X1/4 | 1/4" Pin Punch | 1/4 | 3/8 | 6-3/4 | ASME B107.410 |
| J25TR31C | Pouch | | | | |

4 PIECE PRY AND ROLLING HEAD BARS SET

Product #: **J2100**

- › Set includes rolling head and aligning bars.
- › Black oxide finish to help prevent rust corrosion; extending tool life and performance.
- › Weight (lbs): 8.50



| Contents | Description | Tip Width (in) (A) | Shank Width (in) (B) | Overall Length (in) (L) |
|----------|--------------------------|--------------------|----------------------|-------------------------|
| J2120 | 18" Aligning Pry Bar | 5/8 | 5/8 | 18 |
| J2124 | 24" Aligning Pry Bar | 3/4 | 3/4 | 24 |
| J2126 | 12" Rolling Head Pry Bar | 1/2 | 1/2 | 12 |
| J2130 | 16" Rolling Head Pry Bar | 5/8 | 5/8 | 16 |

11 PIECE FACOM® SHOCK ABSORBING PUNCH SET



Product #: **FA-MOD.CG**

| Description | Tip Width (in) (A) |
|--------------|--------------------|
| Drift Punch | 2 mm |
| Drift Punch | 3 mm |
| Drift Punch | 4 mm |
| Drift Punch | 5 mm |
| Drift Punch | 6 mm |
| Drift Punch | 8 mm |
| Nail Punch | 4 mm |
| Nail Punch | 5 mm |
| Nail Punch | 6 mm |
| Nail Punch | 8 mm |
| Center Punch | 6 mm |



3 PIECE BRASS DRIFT PUNCH SET

Product #: **J9633B**

- › Spark-resistant, mar-resistant.
- › Designed to help prevent damage to the object being struck.
- › Includes a pouch for convenient storage solution.
- › Weight (lbs): 1.65

PROP 65 WARNING: Handling the brass material on this product exposes you to lead, a chemical known to the State of California to cause cancer and birth defects or other reproductive harm. Wash hands after use.



| Contents | Description | Tip Width (in) (A) | Overall Length (in) (L) | ASME Spec. |
|----------|-----------------------------|--------------------|-------------------------|---------------|
| J9634B | 3/4" x 8" Brass Drift Punch | 3/4 | 8 | ASME B107.410 |
| J9612B | 1/2" x 7" Brass Drift Punch | 1/2 | 7 | ASME B107.410 |
| J9638B | 3/8" x 6" Brass Drift Punch | 3/8 | 6 | ASME B107.410 |
| J25TR53C | Pouch | | | |

3 PIECE BRASS HEAVY-DUTY PUNCH SET

Product #: **J9633HB**

- › Spark-resistant, mar-resistant.
- › Designed to help prevent damage to the object being struck.
- › Includes a pouch for convenient storage solution.
- › Weight (lbs): 4.10

PROP 65 WARNING: Handling the brass material on this product exposes you to lead, a chemical known to the State of California to cause cancer and birth defects or other reproductive harm. Wash hands after use.



| Contents | Description | Tip Width (in) (A) | Overall Length (in) (L) | ASME Spec. |
|----------|---------------------------------|--------------------|-------------------------|---------------|
| J9634HB | 3/4" x 12" Brass Drift Punch | 3/4 | 12 | ASME B107.410 |
| J9638HB | 3/8" x 10" Brass Line-up Punch | 3/8 | 10 | ASME B107.410 |
| J96716HB | 7/16" x 14" Brass Line-up Punch | 7/16 | 14 | ASME B107.410 |
| J25TR54C | Pouch | | | |

SUPER-DUTY COLD CHISELS

- › Made from S2 steel and specially heat-treated for greater strength and durability.
- › Hand ground cutting edge to the exact angle for cutting through tough metals.
- › 20% larger striking surface than standard chisels directs the power to the cutting edge.
- › Longer shank features a knurl for better grip and easy positioning.
- › Black oxide finish to help prevent rust corrosion; extending tool life and performance.



| Product # | Tip Width (in) (A) | Shank Width (in) (B) | Overall Length (in) (L) | Weight (lbs) |
|---------------|--------------------|----------------------|-------------------------|--------------|
| J86038 | 3/8 | 5/16 | 6 | 0.13 |
| J86012 | 1/2 | 7/16 | 6-13/16 | 0.26 |
| J86058 | 5/8 | 1/2 | 7-5/8 | 0.44 |
| J86034 | 3/4 | 5/8 | 8-7/16 | 0.75 |
| J86078 | 7/8 | 3/4 | 9-1/4 | 1.09 |
| J86001 | 1 | 7/8 | 10-1/16 | 1.46 |

ASME B107.410

COLD CHISELS

- › Made from S2 steel and specially heat-treated for greater strength and durability.
- › Hand ground cutting edge to the exact angle for cutting through tough metals.
- › Modified parabolic striking end to help reduce mushrooming and chipping.
- › Black oxide finish to help prevent rust corrosion; extending tool life and performance.
- › A polished identification panel on one of the flats is marked with the tool number and size in a black inlay.



| Product # | Tip Width (in) (A) | Shank Width (in) (B) | Overall Length (in) (L) | Weight (lbs) |
|---------------|--------------------|----------------------|-------------------------|--------------|
| J86A3/16S2 | 1/4 | 3/16 | 4-7/8 | 0.04 |
| J86A1/4S2 | 5/16 | 1/4 | 5-1/8 | 0.07 |
| J86A5/16S2 | 3/8 | 5/16 | 5-3/8 | 0.12 |
| J86A3/8S2 | 7/16 | 3/8 | 5-9/16 | 0.17 |
| J86A7/16S2 | 1/2 | 7/16 | 6 | 0.25 |
| J86A7/16X12S2 | 1/2 | 7/16 | 12 | 0.51 |
| J86A1/2S2 | 5/8 | 1/2 | 6-3/4 | 0.37 |
| J86A1/2X12S2 | 5/8 | 1/2 | 12 | 0.68 |
| J86A5/8S2 | 3/4 | 5/8 | 6-7/8 | 0.54 |
| J86A5/8X12S2 | 3/4 | 5/8 | 12 | 1.03 |
| J86A3/4X8S2 | 7/8 | 3/4 | 8 | 0.89 |
| J86A3/4X12S2 | 7/8 | 3/4 | 12 | 1.40 |
| J86A7/8X18S2 | 1 | 7/8 | 18 | 2.42 |
| J86A7/8X8S2 | 1 | 7/8 | 8-1/2 | 1.13 |
| J86A7/8X12S2 | 1 | 7/8 | 12 | 1.75 |
| J86A1X8S2 | 1-3/16 | 1 | 8-1/4 | 1.56 |

 ASME B107.410

CAPE CHISELS

- › Made from S2 steel and specially heat-treated for greater strength and durability.
- › Hand ground cutting edge to the exact angle for cutting through tough metals.
- › Modified parabolic striking end to help reduce mushrooming and chipping.
- › Black oxide finish to help prevent rust corrosion; extending tool life and performance.
- › A polished identification panel on one of the flats is marked with the tool number and size in a black inlay.



| Product # | Tip Width (in) (A) | Shank Width (in) (B) | Overall Length (in) (L) | Weight (lbs) |
|-----------|--------------------|----------------------|-------------------------|--------------|
| J721/4S2 | 3/16 | 1/4 | 4-5/8 | 0.06 |
| J725/16S2 | 5/16 | 5/16 | 5-1/8 | 0.10 |
| J723/8S2 | 1/4 | 3/8 | 5-1/2 | 0.16 |

 ASME B107.410

DIAMOND POINT CHISELS

- ▶ Made from S2 steel and specially heat-treated for greater strength and durability.
- ▶ Hand ground cutting edge to the exact angle for cutting through tough metals.
- ▶ Modified parabolic striking end to help reduce mushrooming and chipping.
- ▶ Black oxide finish to help prevent rust corrosion; extending tool life and performance.
- ▶ A polished identification panel on one of the flats is marked with the tool number and size in a black inlay.



| Product # | Tip Width (in) (A) | Shank Width (in) (B) | Overall Length (in) (L) | Weight (lbs) |
|------------------|--------------------|----------------------|-------------------------|--------------|
| J761/4S2 | 5/32 | 1/4 | 4-1/2 | 0.06 |
| J765/16S2 | 3/16 | 5/16 | 5 | 0.10 |
| J763/8S2 | 1/4 | 3/8 | 5-5/8 | 0.16 |
| J761/2S2 | 5/16 | 1/2 | 6 | 0.30 |
| J765/8S2 | 3/8 | 5/8 | 6-1/2 | 0.44 |



ASME B107.410

PUNCH AND CHISEL HOLDER

- ▶ Holds punches and chisels up to one inch in diameter reducing the risk of injury.
- ▶ Nylon insert absorbs shock.
- ▶ Large four-sided handle.



| Product # | Overall Length (in) (L) | Weight (lbs) |
|--------------|-------------------------|--------------|
| J2108 | 8 | 0.60 |



SUPER-DUTY DRIVE PIN PUNCHES

- ▶ One-piece design for strength and durability.
- ▶ Reverse taper to help prevent binding.
- ▶ Made from S2 steel and specially heat-treated for greater strength and durability.
- ▶ Modified parabolic striking end to help reduce mushrooming and chipping.
- ▶ Black oxide finish to help prevent rust corrosion; extending tool life and performance.
- ▶ A polished identification panel on one of the flats is marked with the tool number and size in a black inlay.

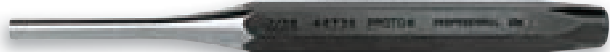

| Product # | Tip Width (in) (A) | Shank Width (in) (B) | Overall Length (in) (L) | Weight (lbs) |
|---------------|--------------------|----------------------|-------------------------|--------------|
| J48116 | 1/16 | 1/4 | 4-1/8 | 0.05 |
| J48332 | 3/32 | 1/4 | 4-1/2 | 0.07 |
| J48018 | 1/8 | 5/16 | 4-3/4 | 0.09 |
| J48532 | 5/32 | 5/16 | 5 | 0.01 |
| J48316 | 3/16 | 3/8 | 5-1/4 | 0.15 |
| J48732 | 7/32 | 7/16 | 5-1/2 | 0.22 |
| J48014 | 1/4 | 7/16 | 5-3/4 | 0.29 |
| J48516 | 5/16 | 1/2 | 6-1/4 | 0.35 |
| J48038 | 3/8 | 5/8 | 6-1/2 | 0.53 |



ASME B107.410

DRIVE PIN PUNCHES

- › Two-piece design allows the tip to be hard for durability while allowing it to be produced straight to help prevent binding.
- › Reverse taper to help prevent binding.
- › Made from S2 steel and specially heat-treated for greater strength and durability.
- › Modified parabolic striking end to help reduce mushrooming and chipping.
- › Black oxide finish to help prevent rust corrosion; extending tool life and performance.
- › A polished identification panel on one of the flats is marked with the tool number and size in a black inlay.



| Product # | Tip Width (in) (A) | Shank Width (in) (B) | Overall Length (in) (L) | Weight (lbs) |
|--------------|--------------------|----------------------|-------------------------|--------------|
| J471/4X1/16 | 1/16 | 1/4 | 4-3/8 | 0.05 |
| J471/4X3/32 | 3/32 | 1/4 | 4-3/4 | 0.06 |
| J475/16X1/8 | 1/8 | 5/16 | 5-3/16 | 0.09 |
| J475/16X5/32 | 5/32 | 5/16 | 5-9/16 | 0.01 |
| J473/8X3/16 | 3/16 | 3/8 | 5-7/8 | 0.15 |
| J477/16X7/32 | 7/32 | 3/8 | 6-3/8 | 0.22 |
| J471/2X1/4 | 1/4 | 3/8 | 6-3/4 | 0.29 |

 ASME B107.410

ROLL PIN PUNCHES

- › One-piece design for strength and durability.
- › Reverse taper to help prevent binding.
- › Made from S2 steel and specially heat-treated for greater strength and durability.
- › Modified parabolic striking end to help reduce mushrooming and chipping.
- › Black oxide finish to help prevent rust corrosion; extending tool life and performance.
- › A polished identification panel on one of the flats is marked with the tool number and size in a black inlay.



| Product # | Tip Width (in) (A) | Shank Width (in) (B) | Overall Length (in) (L) | Weight (lbs) |
|-----------|--------------------|----------------------|-------------------------|--------------|
| J49116S2 | 1/16 | 1/4 | 3-3/4 | 0.04 |
| J49332S2 | 3/32 | 1/4 | 4-1/4 | 0.08 |
| J49018S2 | 1/8 | 5/16 | 4-3/4 | 0.08 |
| J49532S2 | 5/32 | 5/16 | 5-1/4 | 0.08 |
| J49316S2 | 3/16 | 3/8 | 5-7/16 | 0.10 |
| J49732S2 | 7/32 | 3/8 | 5-7/8 | 0.16 |
| J49014S2 | 1/4 | 7/16 | 6-7/16 | 0.16 |
| J49038S2 | 3/8 | 1/2 | 7-1/2 | 0.32 |
| J49012S2 | 1/2 | 5/8 | 7-1/2 | 0.52 |



SUPER-DUTY LONG DRIVE PIN PUNCHES

- › Reverse taper to help prevent binding.
- › Made from S2 steel and specially heat-treated for greater strength and durability.
- › Modified parabolic striking end to help reduce mushrooming and chipping. Black oxide finish to help prevent rust corrosion; extending tool life and performance.
- › A polished identification panel on one of the flats is marked with the tool number and size in a black inlay.



| Product # | Tip Width (in) (A) | Shank Width (in) (B) | Overall Length (in) (L) | Weight (lbs) |
|-----------|--------------------|----------------------|-------------------------|--------------|
| J48532LS2 | 5/32 | 3/8 | 8 | 0.14 |
| J48316LS2 | 3/16 | 3/8 | 8 | 0.15 |
| J48732LS2 | 7/32 | 7/16 | 8 | 0.20 |
| J48014LS2 | 1/4 | 1/2 | 8 | 0.30 |
| J48516LS2 | 5/16 | 1/2 | 8 | 0.41 |

 ASME B107.410

LONG ALIGNING PUNCH

- › Application: to align holes in two or more pieces of metal through which a bolt or screw is to be inserted.
- › One-piece design for strength and durability.
- › Reverse taper to help prevent binding.
- › Made from S2 steel and specially heat-treated for greater strength and durability.
- › Modified parabolic striking end to help reduce mushrooming and chipping.
- › Black oxide finish to help prevent rust corrosion; extending tool life and performance.
- › A polished identification panel on one of the flats is marked with the tool number and size in a black inlay.



| Product # | Tip Width (in) (A) | Shank Width (in) (B) | Overall Length (in) (L) | Weight (lbs) |
|-----------------|--------------------|----------------------|-------------------------|--------------|
| J155/8S2 | 3/16 | 5/8 | 16 | 0.90 |

 ASME B107.410

DRIFT PUNCHES

- › Application: to align holes in two or more pieces of metal through which a bolt or screw is to be inserted.
- › Application: for installing and removing pins and shafts.
- › One-piece design for strength and durability.
- › Reverse taper to help prevent binding.
- › Made from S2 steel and specially heat-treated for greater strength and durability.
- › Modified parabolic striking end to help reduce mushrooming and chipping.
- › Black oxide finish to help prevent rust corrosion; extending tool life and performance.
- › A polished identification panel on one of the flats is marked with the tool number and size in a black inlay.



| Product # | Tip Width (in) (A) | Shank Width (in) (B) | Overall Length (in) (L) | Weight (lbs) |
|------------------|--------------------|----------------------|-------------------------|--------------|
| J961/4S2 | 3/32 | 1/4 | 10 | 0.12 |
| J965/16S2 | 1/8 | 5/16 | 10 | 0.19 |
| J963/8S2 | 3/16 | 3/8 | 10 | 0.28 |
| J967/16S2 | 7/32 | 7/16 | 10 | 0.37 |
| J961/2S2 | 1/4 | 1/2 | 10 | 0.49 |
| J965/8S2 | 5/16 | 5/8 | 10 | 0.70 |
| J963/4S2 | 3/8 | 3/4 | 10 | 1.02 |

 ASME B107.410

STARTING PUNCHES

- › Similar to drift punches, but with wider points and heavier, shorter body.
- › Application: to align holes in two or more pieces of metal through which a bolt or screw is to be inserted.
- › Application: for installing and removing pins and shafts.
- › One-piece design for strength and durability.
- › Reverse taper to help prevent binding.
- › Made from S2 steel and specially heat-treated for greater strength and durability.
- › Modified parabolic striking end to help reduce mushrooming and chipping.
- › Black oxide finish to help prevent rust corrosion; extending tool life and performance.
- › A polished identification panel on one of the flats is marked with the tool number and size in a black inlay.



| Product # | Tip Width (in) (A) | Shank Width (in) (B) | Overall Length (in) (L) | Weight (lbs) |
|------------------|--------------------|----------------------|-------------------------|--------------|
| J503/16S2 | 1/16 | 1/4 | 4-1/8 | 0.03 |
| J501/4S2 | 3/32 | 1/4 | 5 | 0.06 |
| J505/16S2 | 1/8 | 5/16 | 5-1/8 | 0.10 |
| J503/8S2 | 3/16 | 3/8 | 5-5/8 | 0.17 |
| J507/16S2 | 7/32 | 7/16 | 6 | 0.24 |
| J501/2S2 | 1/4 | 1/2 | 6-1/2 | 0.33 |

 ASME B107.410

CENTER PUNCHES

- › Application: metal working layout. Provides a broad dent in marking intersecting center lines, hole locations, and pilot drill starting point.
- › One-piece design for strength and durability.
- › Made from S2 steel and specially heat-treated for greater strength and durability.
- › Modified parabolic striking end to help reduce mushrooming and chipping.
- › Black oxide finish to help prevent rust corrosion; extending tool life and performance.
- › A polished identification panel on one of the flats is marked with the tool number and size in a black inlay.

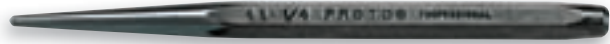

| Product # | Shank Width (in) (B) | Overall Length (in) (L) | Weight (lbs) |
|-----------|----------------------|-------------------------|--------------|
| J411/4S2 | 1/4 | 4-3/4 | 0.05 |
| J415/16S2 | 5/16 | 4-5/8 | 0.09 |
| J413/8S2 | 3/8 | 4-7/8 | 0.14 |
| J417/16S2 | 7/16 | 5-1/4 | 0.19 |
| J411/2S2 | 1/2 | 5-5/8 | 0.29 |
| J415/8S2 | 5/8 | 6-1/4 | 0.45 |

ASME B107.410

PRICK PUNCHES

- › Application: sheet metal work for scribing and for punching starting holes for sheet metal screws.
- › One-piece design for strength and durability.
- › Reverse taper to help prevent binding.
- › Made from S2 steel and specially heat-treated for greater strength and durability.
- › Modified parabolic striking end to help reduce mushrooming and chipping.
- › Black oxide finish to help prevent rust corrosion; extending tool life and performance.
- › A polished identification panel on one of the flats is marked with the tool number and size in a black inlay.



| Product # | Shank Width (in) (B) | Overall Length (in) (L) | Weight (lbs) |
|-----------|----------------------|-------------------------|--------------|
| J441/4S2 | 1/4 | 4-3/4 | 0.06 |
| J445/16S2 | 5/16 | 5 | 0.09 |
| J443/8S2 | 3/8 | 5-1/4 | 0.14 |

ASME B107.410

BRASS DRIFT PUNCHES

- › Spark-resistant, mar-resistant.
- › Designed to help prevent damage to the object being struck.



PROP 65 WARNING: Handling the brass material on this product exposes you to lead, a chemical known to the State of California to cause cancer and birth defects or other reproductive harm. Wash hands after use.

| Product # | Tip Width (in) (A) | Overall Length (in) (L) | Weight (lbs) |
|-----------|--------------------|-------------------------|--------------|
| J49920 | 1/2 | 7-7/8 | 0.46 |
| J9634B | 3/4 | 8 | 1.05 |
| J9638B | 3/8 | 6 | 0.20 |
| J9634HB | 3/4 | 12 | 1.60 |
| J9612B | 1/2 | 7 | 0.40 |

ASME B107.410

BRASS LINE-UP PUNCHES

- ▶ Spark-resistant, mar-resistant.
- ▶ Designed to help prevent damage to the object being struck.

PROP 65 WARNING: Handling the brass material on this product exposes you to lead, a chemical known to the State of California to cause cancer and birth defects or other reproductive harm. Wash hands after use.



| Product # | Tip Width (in) (A) | Overall Length (in) (L) | Weight (lbs) |
|-----------|--------------------|-------------------------|--------------|
| J9638HB | 3/8 | 10 | 1.00 |
| J96716HB | 7/16 | 14 | 1.50 |

 ASME B107.410

PRY BARS

- ▶ Large four-sided handle for a better grip and added comfort.



| Product # | Tip Width (in) (A) | Overall Length (in) (L) | Weight (lbs) |
|-----------|--------------------|-------------------------|--------------|
| J2140 | 5/8 | 14-1/2 | 0.92 |
| J2142 | 5/8 | 17-1/2 | 1.08 |
| J2146 | 3/4 | 28 | 1.37 |
| J2148 | 3/4 | 31-7/8 | 2.17 |



ALIGNING PRY BARS

- ▶ Application: for prying, positioning, and aligning applications.



| Product # | Tip Width (in) (A) | Shank Width (in) (B) | Overall Length (in) (L) | Weight (lbs) |
|-----------|--------------------|----------------------|-------------------------|--------------|
| J2116 | 1/2 | 1/2 | 16 | 0.77 |
| J2120 | 5/8 | 5/8 | 18 | 1.23 |
| J2124 | 3/4 | 3/4 | 24 | 2.36 |
| J2125 | 7/8 | 7/8 | 30 | 4.72 |



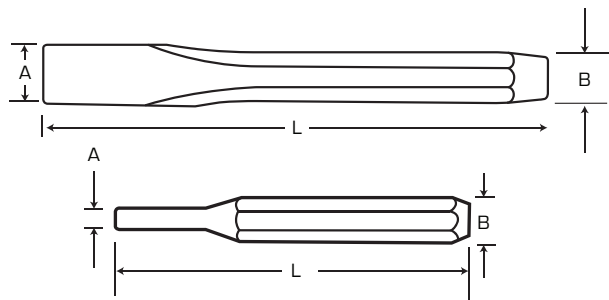

ROLLING HEAD BARS

- › Application: Pry and aligning bar with a long pointed taper and 90° rolling head for leverage.



| Product # | Tip Width (in) (A) | Shank Width (in) (B) | Overall Length (in) (L) | Weight (lbs) |
|-----------|--------------------|----------------------|-------------------------|--------------|
| J2126 | 1/2 | 1/2 | 12 | 1.30 |
| J2130 | 5/8 | 5/8 | 16 | 2.40 |



BALL PEIN HAMMERS - INDUSTRIAL FIBERGLASS HANDLE

- › Well-balanced professional hammer with hardened drop-forged head bonded to strong, lightweight fiberglass handle.
- › Exclusive Rim-Tempered™ process minimizes chipping from off-center strikes.
- › Molded jacket over the fiberglass handle provides maximum overstrike protection.



| Product # | Head Weight | Overall Length (in) (L) | Weight (lbs) |
|-----------|-------------|-------------------------|--------------|
| J1312PGD | 12 oz. | 12-1/16 | 1.31 |
| J1316PGD | 16 oz. | 13 | 1.54 |
| J1324PGD | 24 oz. | 14-3/16 | 2.18 |
| J1332PGD | 32 oz. | 15-1/4 | 2.62 |



ASME B107.400

BALL PEIN HAMMERS - INDUSTRIAL WOOD HANDLE

- › Tough drop-forged head with Rim-Tempered™ hardened face and pein.
- › Face, chamfer, cheeks and pein are polished and have a protective coating of clear lacquer.
- › Hardwood handles have contoured shape with red lacquer grip.



| Product # | Head Weight | Overall Length (in) (L) | Weight (lbs) |
|-----------|-------------|-------------------------|--------------|
| J1304PD | 4 oz. | 11 | 0.45 |
| J1308PD | 8 oz. | 12 | 0.83 |
| J1312PD | 12 oz. | 13 | 1.14 |
| J1316PD | 16 oz. | 14-1/2 | 1.45 |
| J1324PD | 24 oz. | 15 | 2.00 |
| J1332PD | 32 oz. | 15-7/8 | 2.42 |
| J1340PD | 40 oz. | 16-3/8 | 2.84 |



ASME B107.400



RUBBER MALLET

- › Soft but tough, flake-resistant Neoprene head prevents damage.
- › Hickory handle.



| Product # | Face Diameter (in) (D) | Head Length (in) (H) | Overall Length (in) (L) | Weight (lbs) |
|--------------|------------------------|----------------------|-------------------------|--------------|
| J1368 | 2-1/4 | 4 | 13-1/2 | 1.43 |

TWO-WAY HAMMER

- › Has a combined forged steel and replaceable rubber head.
- › Hickory handle.



| Product # | Face Diameter (in) (D) | Head Length (in) (H) | Overall Length (in) (L) | Weight (lbs) |
|---------------|------------------------|----------------------|-------------------------|--------------|
| J1448A | 2-1/16 x 1-1/2 | 5-1/2 | 16 | 2.50 |

SOFT FACE HAMMER - MEDIUM/TOUGH TIPS

- › Two mar-resistant plastic tips, one medium, and one tough.
- › Tips are screw-on and replaced easily.
- › Fiberglass handle with ergonomic, non-slip grip.



| Product # | Face Diameter (in) (D) | Head Length (in) (H) | Overall Length (in) (L) | Weight (lbs) |
|--------------|------------------------|----------------------|-------------------------|--------------|
| J1360 | 1-3/16 | 2-3/4 | 13-21/64 | 0.81 |
| J1362 | 1-11/32 | 2-3/16 | 13-15/32 | 1.05 |
| J1364 | 1-11/16 | 4-11/16 | 14-53/64 | 2.06 |

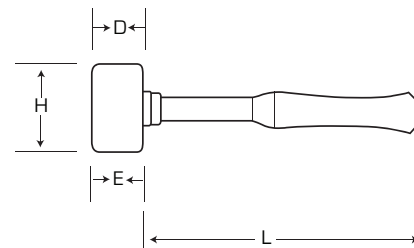

SOFT FACE HAMMER - MEDIUM/HARD TIPS

- › Each hammer comes with one medium and one hard tip installed.
- › Fiberglass handle with ergonomic, non-slip grip.



| Product # | Face Diameter (in) (D) | Head Length (in) (H) | Tip Series | Overall Length (in) (L) | Weight (lbs) |
|-----------------|------------------------|----------------------|------------------|-------------------------|--------------|
| JSF105HM | 1 | 2 | SF10 Series Tips | 13 | 0.60 |
| JSF150HM | 1-1/2 | 2-3/8 | SF15 Series Tips | 13-1/2 | 0.79 |
| JSF200HM | 2 | 2-1/2 | SF20 Series Tips | 14 | 1.43 |
| JSF205HM | 2 | 2-1/2 | SF20 Series Tips | 14 | 2.06 |



SOFT FACE HAMMER - WITHOUT TIPS

- › Fiberglass handle with ergonomic, non-slip grip.



| Product # | Face Diameter (in) (D) | Head Length (in) (H) | Tip Series | Overall Length (in) (L) | Weight (lbs) |
|---------------|------------------------|----------------------|------------------|-------------------------|--------------|
| JSF100 | 1 | 2 | SF10 Series Tips | 12 | 0.36 |
| JSF105 | 1 | 2 | SF10 Series Tips | 12 | 0.52 |
| JSF150 | 1-1/2 | 2-3/8 | SF15 Series Tips | 13-1/2 | 0.85 |
| JSF155 | 1-1/2 | 2-3/8 | SF15 Series Tips | 13-1/2 | 1.02 |
| JSF200 | 2 | 2-1/2 | SF20 Series Tips | 15 | 1.01 |
| JSF205 | 2 | 2-1/2 | SF20 Series Tips | 15 | 1.80 |
| JSF250 | 2-1/2 | 3-1/4 | SF25 Series Tips | 16-1/2 | 2.00 |



SOFT FACE HAMMER TIPS

- › Tips screw on.
- › Easy to replace.

| Product # | Hardness | For Use On | Weight (lbs) |
|---------------|----------|------------|--------------|
| J1360M | Medium | J1360 | 0.04 |
| J1360T | Tough | J1360 | 0.04 |
| J1384M | Medium | J1362 | 0.05 |
| J1384T | Tough | J1362 | 0.05 |
| J1364M | Medium | J1364 | 0.10 |
| J1364T | Tough | J1364 | 0.10 |



SURFACE PROTECTIVE TIPS

| Product # | Hardness | Color | Weight (lbs) |
|----------------|-------------|--------|--------------|
| JSF10S | Soft | Brown | 0.05 |
| JSF10M | Medium | Red | 0.09 |
| JSF10T | Tough | Green | 0.05 |
| JSF10MH | Medium Hard | Cream | 0.05 |
| JSF10H | Hard | Black | 0.04 |
| JSF10XH | Extra Hard | Yellow | 0.04 |
| JSF15SS | Super Soft | Grey | 0.09 |
| JSF15S | Soft | Brown | 0.10 |
| JSF15M | Medium | Red | 0.10 |
| JSF15T | Tough | Green | 0.10 |
| JSF15MH | Medium Hard | Cream | 0.08 |
| JSF15H | Hard | Black | 0.09 |
| JSF15XH | Extra Hard | Yellow | 0.80 |
| JSF20S | Soft | Brown | 0.20 |
| JSF20M | Medium | Red | 0.21 |
| JSF20T | Tough | Green | 0.22 |
| JSF20MH | Medium Hard | Cream | 0.20 |
| JSF20H | Hard | Black | 0.23 |
| JSF20XH | Extra Hard | Yellow | 0.20 |
| JSF25M | Medium | Red | 0.42 |
| JSF25T | Tough | Green | 0.38 |
| JSF25MH | Medium Hard | Cream | 0.39 |
| JSF25H | Hard | Black | 0.36 |
| JSF25XH | Extra Hard | Yellow | 0.37 |



- › Proto® threaded tips are available in seven different hardnesses for each size tip, from super soft to extra hard. They fit universal hammers and offer the following features:
 - › Resistant to oil, gasoline, and common industrial chemicals.
 - › Helps eliminate sting, vibration, and rebound.
 - › Non-combustible.
 - › Color coded for degree of hardness for easy identification.

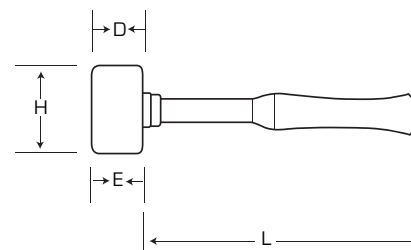

SLEDGE HAMMERS - DOUBLE FACED

- › Designed for striking metal, concrete, and stone.
- › Strong fiberglass handle with slip-resistant cushion grip.



| Product # | Head Weight | Face Diameter (in) (D) | Head Length (in) (H) | Overall Length (in) (L) | Weight (lbs) |
|---------------|-------------|------------------------|----------------------|-------------------------|--------------|
| J1433G | 2.5 lbs. | 1-11/16 | 3 | 15-11/16 | 3.28 |
| J1434G | 3 lbs. | 1-7/8 | 4-1/2 | 15-7/8 | 3.94 |
| J1435G | 4 lbs. | 2 | 5 | 16 | 4.84 |
| J1436G | 6 lbs. | 2-1/4 | 5-3/4 | 34-1/4 | 8.05 |
| J1437G | 8 lbs. | 2-3/8 | 6-1/2 | 34-3/8 | 10.14 |
| J1438G | 10 lbs. | 2-1/2 | 7-1/2 | 34-1/2 | 12.36 |
| J1439G | 12 lbs. | 2-3/4 | 7-3/8 | 34-3/4 | 14.50 |



ASME B107.54M

CROSS PEIN HAMMERS

- › For use with unhardened metals.
- › Pein is designed for shaping and bending metals.
- › Strong fiberglass handle with slip-resistant cushion grip.



| Product # | Head Weight | Face Diameter (in) (D) | Head Length (in) (H) | Overall Length (in) (L) | Weight (lbs) |
|---------------|-------------|------------------------|----------------------|-------------------------|--------------|
| J1440G | 2.5 lbs. | 1-3/4 | 5 | 15-3/4 | 3.89 |
| J1441G | 4 lbs. | 1-15/16 | 5-35/64 | 15-15/16 | 4.45 |

ASME B107.54M

HAND DRILLING HAMMERS

- › Well-balanced, drop-forged steel head with a hardened face.
- › Designed for use with chisels, punches, star drills, and hardened nails.
- › Fiberglass handle with ergonomic, non-slip grip.



| Product # | Head Weight | Face Diameter (in) (D) | Head Length (in) (H) | Overall Length (in) (L) | Weight (lbs) |
|---------------|-------------|------------------------|----------------------|-------------------------|--------------|
| J1442G | 2 lbs. | 1-3/8 | 4-1/8 | 11-3/8 | 2.72 |
| J1443G | 3 lbs. | 1-5/8 | 4-3/8 | 11-5/8 | 3.70 |
| J1444G | 4 lbs. | 1-15/16 | 4-3/4 | 11-15/16 | 4.32 |

ASME B107.54M

BRASS HAMMERS

- › Mar-resistant soft brass head helps absorb impact and helps reduce work damage.
- › Spark-resistant for safe use near combustible materials.
- › Fiberglass handle with ergonomic, non-slip grip.



PROP 65 WARNING: Handling the brass material on this product exposes you to lead, a chemical known to the State of California to cause cancer and birth defects or other reproductive harm. Wash hands after use.

| Product # | Head Weight | Face Diameter (in) (D) | Head Length (in) (H) | Overall Length (in) (L) | Weight (lbs) |
|---------------|-------------|------------------------|----------------------|-------------------------|--------------|
| J1430G | 1.5 lbs. | 1-1/2 | 3-1/2 | 13-1/2 | 2.09 |
| J1432G | 2.6 lbs. | 1-3/4 | 3-1/2 | 13-3/4 | 3.45 |
| J1431G | 3.8 lbs. | 2 | 3-5/8 | 14-3/4 | 4.38 |

ASME B107.54M

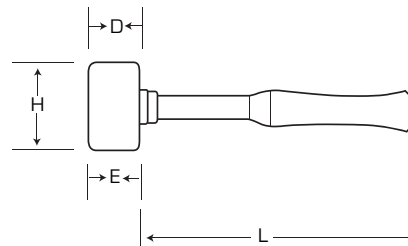

DEAD BLOW HAMMERS

- › Spark-resistant for safe use near combustible materials.
- › Head contains steel shot to help prevent rebound and vibration.
- › Fiberglass handle.



| Product # | Head Weight | Face Diameter (in) (D) | Head Length (in) (H) | Overall Length (in) (L) | Weight (lbs) |
|----------------|-------------|------------------------|----------------------|-------------------------|--------------|
| J1429DB | 1 lbs. | 1-5/8 | 4 | 13-5/8 | 1.73 |
| J1430DB | 2 lbs. | 2 | 4-3/8 | 14-3/4 | 2.16 |
| J1432DB | 3 lbs. | 2-7/16 | 4-5/8 | 16-7/16 | 2.16 |
| J1431DB | 4 lbs. | 2-5/8 | 5 | 17 | 3.28 |

DEAD BLOW COMPO-CAST® COMBO FACE HAMMERS

- › Top welded handle-to-head assembly adds extra durability and safety.
- › Hot urethane Uni-Cast construction outlasts all other soft face striking tools. Urethane composition provides shape-retaining faces even after repeated striking on hard surfaces and sharp edges.
- › Handle is reinforced with solid steel shaft for greater strength safety.
- › Top of head molded with a flat surface.
- › Dual head design (Standard Dead Blow and Slim-line heads).
- › Comfortable dual molded grip.



Top of head molded with flat surface.



Dual head design (standard dead blow and slim-line heads).



Double flange butt handle.



| Product # | Head Weight | Face Diameter (in) (D) | Head Length (in) (H) | Overall Length (in) (L) | Weight (lbs) |
|----------------|-------------|------------------------|----------------------|-------------------------|--------------|
| J57-530 | 15 oz | 1 x 1-1/4 | 3-47/64 | 10-13/32 | 0.90 |
| J57-531 | 21 oz | 1-1/4 x 1-35/64 | 4-17/32 | 11-21/32 | 1.40 |
| J57-532 | 28 oz | 1-11/32 x 1-45/64 | 5-9/64 | 13-1/4 | 1.80 |
| J57-533 | 46 oz | 1-45/64 x 2-3/32 | 5-51/64 | 14-1/4 | 2.95 |
| J57-534 | 56 oz | 1-61/64 x 2-13/32 | 6-13/64 | 15-61/64 | 3.70 |

PISTON DEAD BLOW COMPO-CAST® SMALL FACE MALLET

- › Extended head for long reach.
- › Top welded handle-to-head assembly adds extra durability and safety.
- › Hot urethane Uni-Cast construction outlasts all other soft face striking tools. Urethane composition provides shape-retaining faces even after repeated striking on hard surfaces and sharp edges.
- › Handle is reinforced with solid steel shaft for greater strength safety.



| Product # | Face Diameter (in) (D) | Head Length (in) (H) | Overall Length (in) (L) | Weight (lbs) |
|----------------|------------------------|----------------------|-------------------------|--------------|
| J57-544 | 1-17/32 | 8-3/8 | 12-7/8 | 1.85 |

WE DON'T JUST MAKE PULLERS, WE MAKE PULLING SYSTEMS.

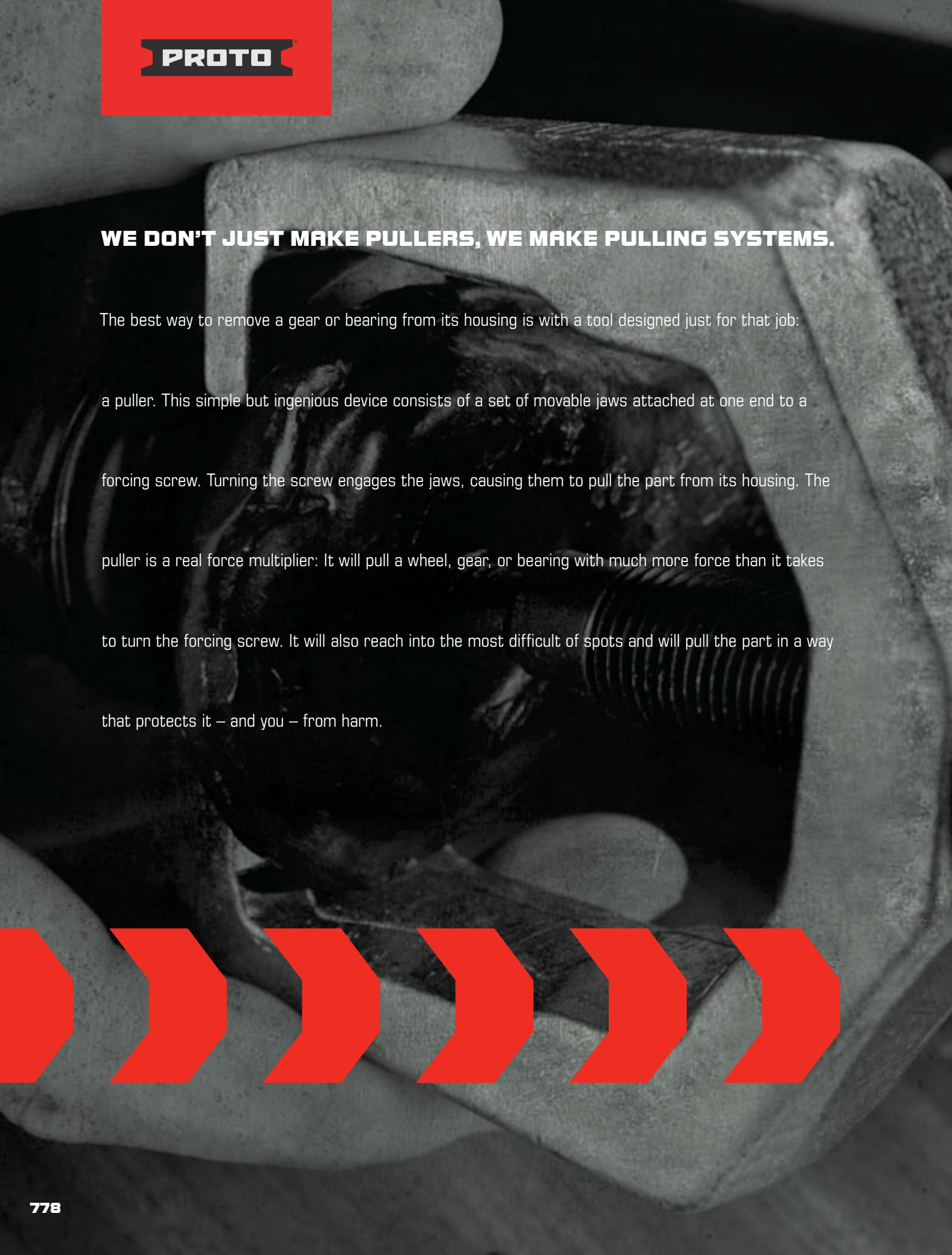
A close-up, black and white photograph of a puller tool being used to remove a bearing from a metal housing. The puller's jaws are visible, gripping the inner ring of the bearing. A large, threaded forcing screw is being turned, which pulls the bearing out of the housing. The background is dark and out of focus, emphasizing the mechanical action.

The best way to remove a gear or bearing from its housing is with a tool designed just for that job: a puller. This simple but ingenious device consists of a set of movable jaws attached at one end to a forcing screw. Turning the screw engages the jaws, causing them to pull the part from its housing. The puller is a real force multiplier: It will pull a wheel, gear, or bearing with much more force than it takes to turn the forcing screw. It will also reach into the most difficult of spots and will pull the part in a way that protects it – and you – from harm.

PULLERS

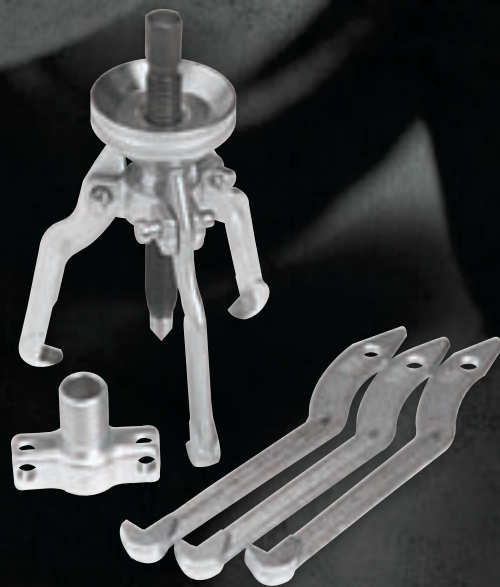

6 TON PROTO-EASE™ 2-WAY/3-WAY CONE PULLER SET

PROTO

6 TON GENERAL PULLER SET

Product #: J4289B

- › Makes 12 of the most commonly used pullers: Internal, External and Slide hammer.
- › Weight (lbs): 17.34

| Contents | Description | Qty. |
|----------|-------------------------------|------|
| J4260R | T-Handles Rod, 24" Long | 1 |
| J4260H | Slide Hammer, 2-1/2 lbs. | 1 |
| J4250N | Reversible Adjusting Nut | 1 |
| J4250B | 2 Jaw Yoke | 1 |
| J4255B | 3 Jaw Yoke | 1 |
| J4205B | Slotted Crossarm, 2-Way/3-Way | 1 |
| J4056-6 | Reversible Jaw, 6" Reach | 3 |
| J4056-4 | Reversible Jaw, 4" Reach | 3 |
| J4056-2 | Inside Jaw, 2" Reach | 2 |
| J4056PN | Jaw Pivot Pin | 3 |
| J4256S | Inside Hook Jaw | 1 |
| J4205S | Forcing Screw | 1 |
| J4022T | Standard Detachable Tip | 1 |
| J4028 | Cap Screw, 3/8"-16 UNC x 3" | 3 |
| J4005C | Cap Screw, 3/8"-24 UNF x 3" | 3 |
| J4205E | Cap Screw, 3/8"-16 UNC x 4" | 3 |
| J4951PB | Blow-Molded Case | 1 |



6 TON WIDE PULLER SET

Product #: J4291B

- › Designed for pulling machine parts up to 8" in diameter with reach depths to over 7".
- › Makes over 12 different adjustable and straight jaw pullers.
- › Weight (lbs): 29.00

| Contents | Description | Qty. |
|----------|------------------------------------|------|
| J4205S | Forcing Screw | 1 |
| J4022T | Standard Detachable Tip | 1 |
| J4208CA | 2-Way/3-Way Crossarm, 7" Long | 1 |
| J4027 | Narrow Jaw | 3 |
| J4026A | Dual-Reach Jaws | 3 |
| J4021S | Spring Clip | 3 |
| J4211BA | Adjustable Jaw Block Assembly | 3 |
| J4206SC | Slotted Crossarm, 2-Way | 1 |
| J4028 | Cap Screw, 3/8"-16 UNC x 3" | 2 |
| J4332 | Bearing Separator, 4-3/8" Capacity | 1 |
| J4055H | 5 lbs. Slide Hammer | 1 |
| J4260R | T-Handles Rod, 24" Long | 1 |
| J4952PB | Blow-Molded Case | 1 |



6 TON STANDARD PULLER SET

Product #: **J4290B**

- › Makes over 20 of the most often used pullers: Internal, External, Slide Hammer, Rear Axle, Harmonic Balancer, etc.
- › Weight (lbs): 27.68

| Contents | Description | Qty. |
|----------|-------------------------------|------|
| J4260R | T-Handle Slide Rod, 24" Long | 1 |
| J4260H | 2-1/2 lbs. Slide Hammer | 1 |
| J4250N | Reversible Adjusting Nut | 1 |
| J4250B | Two Jaw Yoke | 1 |
| J4255B | Three Jaw Yoke | 1 |
| J4205B | Slotted Crossarm, 2-Way/3-Way | 1 |
| J4056-6 | Reversible Jaw, 6" Reach | 3 |
| J4056-4 | Reversible Jaw, 4" Reach | 3 |
| J4056-2 | Inside Jaw, 2" Reach | 2 |
| J4056PN | Jaw Pivot Pin | 3 |
| J4256S | Inside Hook Jaw | 1 |
| J4205S | Forcing Screw | 1 |
| J4022T | Standard Detachable Tip | 1 |
| J4028 | Cap Screw, 3/8"-16 UNC x 3" | 3 |
| J4005C | Cap Screw, 3/8"-24 UNF x 3" | 3 |
| J4205E | Cap Screw, 3/8"-16 UNC x 4" | 3 |
| J4055H | 5 lbs. Slide Hammer | 1 |
| J4275R | Short Slide Rod, 12-3/4" Long | 1 |
| J4277B | Rear Axle Flange Foot | 1 |
| J4280 | Set Puller Blind Bearing | 1 |
| J4331 | Gear and Bearing Separator | 1 |
| J4951PB | Blow-Molded Case | 1 |



10 TON PROTO-EASE™ WIDE PULLER SET

Product #: **J4292B**

- › Required for large parts with heavy press-fits.
- › Reaches to over 12" and spread of 11"
- › Makes over 10 different adjustable and straight jaw pullers.
- › Weight (lbs): 39.00

| Contents | Description | Qty. |
|----------|-------------------------------|------|
| J4225S | Forcing Screw | 1 |
| J4012T | Standard Tip | 1 |
| J4226CA | 2-Way Crossarm, 11" Long | 1 |
| J4227CA | 3-Way Crossarm, 11" Long | 1 |
| J4231A | Adjustable Jaw Block Assembly | 3 |
| J4016A | Dual Reach Jaw | 3 |
| J4018 | Cap Screw Jaw | 3 |
| J4017 | Long Narrow Jaw | 3 |
| J4011S | Spring Clip | 3 |
| J4333 | Bearing Separator | 1 |
| J4953PB | Blow-Molded Case | 1 |



PROTO-EASE™ BEARING SEPARATOR SET**Product #: J4390B**

- › Removes gears and bearings too close to another surface for a puller jaw grip, or where the pulled out part must be protected.
- › Case provides space for step plates and assorted accessories.
- › Weight (lbs): 27.50

| Contents | Description | Qty. |
|----------|---|------|
| J4330 | Gear and Bearing Separator, 1-13/16" Capacity | 1 |
| J4331 | Gear and Bearing Separator, 2-13/32" Capacity | 1 |
| J4332 | Gear and Bearing Separator, 4-3/8" Capacity | 1 |
| J4333A | Gear and Bearing Separator, 6" Capacity | 1 |
| J4333R | Threaded Rod, 3/4"-16 UNF, 10" Long | 2 |
| J4955PB | Blow-Molded Case | 1 |

**10 TON PROTO-EASE™ PRESS-N-PULL™ SET****Product #: J4293B**

- › Presses parts into place without hydraulics.
- › Functions as many different pullers either by itself or in combination with other Proto® Pullers.
- › Weight (lbs): 43.00

| Contents | Description | Qty. |
|-----------|---|------|
| J4012T | Standard Tip | 1 |
| J4229LS | Lock Screw, 7/16"-14 UNC x 3/4" | 3 |
| J4235AA | Adapter, 3/4"-12 Female x 5/8" Male Acme | 1 |
| J4235CN | Coupling Nut, 3/4"-12 Acme | 1 |
| J4235S | Forcing Screw | 1 |
| J4235UA | Adapter, 3/4"-12 Female Acme x 5/8" 18 UNF Male | 1 |
| J4236CA | 2-Way Crossarm | 1 |
| J4236N | Forcing Nut | 1 |
| J4236W | Thrust Washer | 1 |
| J4237CA | 3-Way Crossarm | 1 |
| J4239SB | Slideblock | 3 |
| J4240-08F | Adapter, 5/8" x 1/2" Female | 3 |
| J4240-08M | Adapter, 5/8" x 1/2" Male | 3 |
| J4240-12F | Adapter, 5/8" x 3/4" Female | 3 |
| J4240-12M | Adapter, 5/8" x 3/4" Male | 3 |
| J4240-14F | Adapter, 5/8" x 7/8" Female | 3 |
| J4240-14M | Adapter, 5/8" x 7/8" Male | 3 |
| J4240L | Medium Leg | 3 |
| J4240SL | Short Leg | 3 |
| J4333 | Bearing Separator | 1 |
| J4954PB | Blow-Molded Case | 1 |



PROTO-EASE™ GENERAL PULLER SET

Product #: **J4245**



- › Includes components to assemble a wide variety of 3 ton, 6 ton, 10 ton, slide hammer and threaded part pullers.
- › Weight (lbs): 46.13

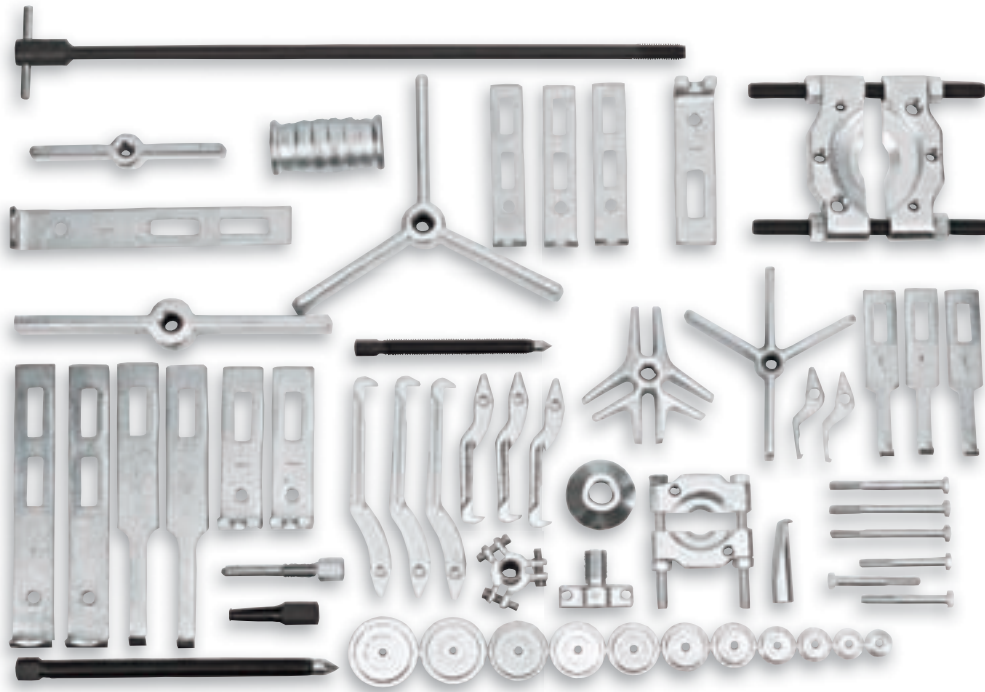

| Contents | Description | Qty. |
|----------|---|------|
| J4005C | Cap Screw, 3/8"-24 UNF x 3" | 3 |
| J4011S | Spring Clip | 3 |
| J4016A | Dual-Reach Jaws | 1 |
| J4017 | Long Narrow Jaw | 1 |
| J4018 | Cap Screw Jaw | 1 |
| J4021S | Jaw Spring Clip | 3 |
| J4026A | Dual Reach Jaw | 3 |
| J4027 | Narrow Jaw | 3 |
| J4040 | Step Plate Adapter Set | 1 |
| J4056-2 | Inside Jaw, 2" Reach | 2 |
| J4205B | Slotted Crossarm 2-Way/3-Way | 1 |
| J4205E | Cap Screw, 3/8"-16 UNC x 4" | 3 |
| J4206CA | 2-Way Crossarm | 1 |
| J4208CA | 2-Way/3-Way Crossarm | 1 |
| J4227CA | 3-Way Crossarm, 11" Long | 1 |
| J4234 | 10 Ton 2-Way Straight Jaw Puller Set | 1 |
| J4252 | 6 Ton 2-Way/3-Way Cone Puller Set | 1 |
| J4256S | Inside-Hook Jaw | 1 |
| J4260H | 2-1/2 lbs. Slide Hammer | 1 |
| J4260R | T-Handle Slide Rod, 24" Long | 1 |
| J4280 | Set Puller Blind Bearing | 1 |
| J4331 | Gear and Bearing Separator, 2-13/32" Capacity | 1 |
| J4332 | Gear and Bearing Separator, 4-3/8" Capacity | 1 |



PROTO-EASE™ MASTER PULLER SET**Product #: J4235A**

- › Covers most maintenance operations using standard pullers.
- › Contains components necessary to assemble all full-interchange system pullers except Proto® Press-N-Pull™ Pullers.
- › Weight (lbs): 73.00

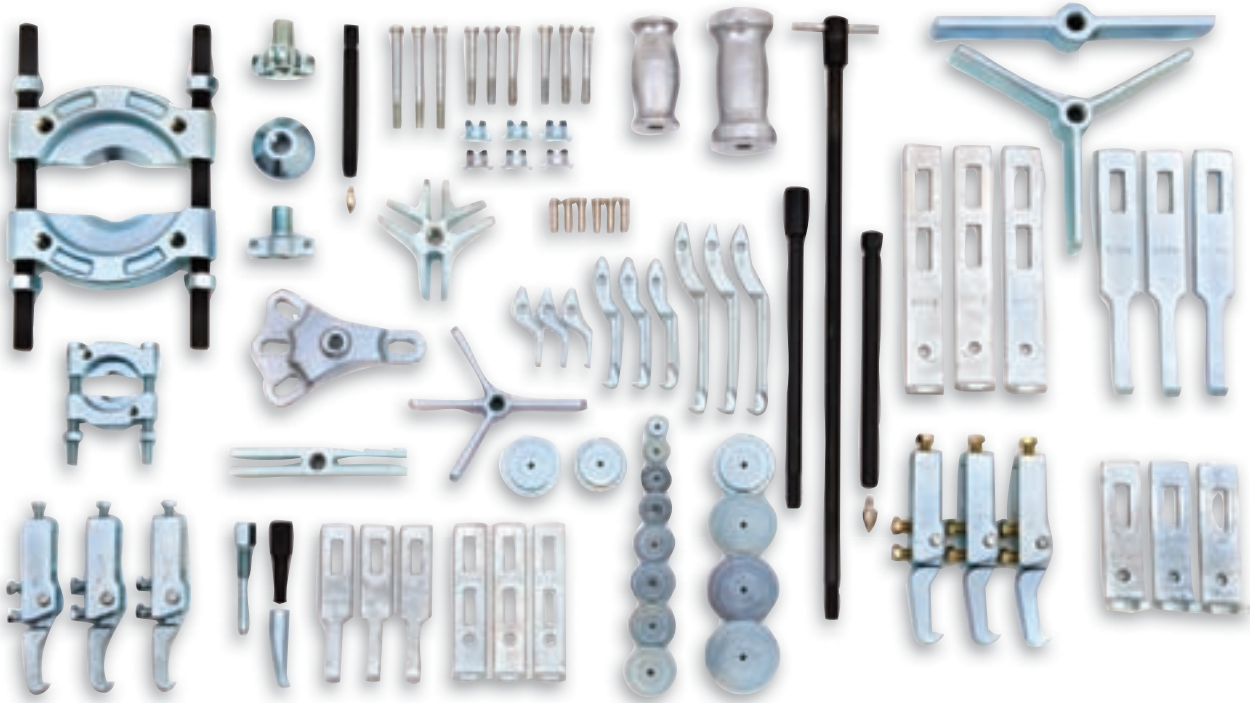

| Contents | Description | Qty. |
|----------|-------------------------------|------|
| J4205B | Slotted Crossarm, 2-Way/3-Way | 1 |
| J4022T | Standard Detachable Tip | 1 |
| J4205S | Forcing Screw | 1 |
| J4005C | Cap Screw, 3/8"-24 UNF x 3" | 3 |
| J4205E | Cap Screw, 3/8"-16 UNC x 4" | 3 |
| J4028 | Cap Screw, 3/8"-16 UNC x 3" | 3 |
| J4206SC | Slotted Crossarm, 2-Way | 1 |
| J4250B | 2 Jaw Yoke | 1 |
| J4255B | 3 Jaw Yoke | 1 |
| J4056-2 | Inside Jaw, 2" Reach | 3 |
| J4056-4 | Reversible Jaw, 4" Reach | 3 |
| J4056-6 | Reversible Jaw, 6" Reach | 3 |
| J4250N | Reversible Adjusting Nut | 1 |
| J4056PN | Jaw Pivot Pin | 3 |
| J4260H | 2-1/2 lbs. Slide Hammer | 1 |
| J4260R | T-Handle Slide Rod, 24" Long | 1 |
| J4055H | 5 lbs. Slide Hammer | 1 |
| J4275R | Short Slide Rod | 1 |
| J4277B | Rear Axle Flange Foot | 1 |
| J4256S | Inside Hook Jaw | 1 |
| J4280 | Set Puller Blind Bearing | 1 |

| Contents | Description | Qty. |
|----------|--------------------------------------|------|
| J4211BA | Adjustable Jaw Block Assembly | 3 |
| J4026A | Dual-Reach Jaw | 3 |
| J4027 | Narrow Jaw | 3 |
| J4208CA | 2-Way/3-Way Crossarm | 1 |
| J4231A | Adjustable Jaw Block Assembly | 3 |
| J4012T | Standard Tip | 1 |
| J4225S | Forcing Screw | 1 |
| J4226CA | 2-Way Crossarm, 11" Long | 1 |
| J4227CA | 3-Way Crossarm, 11" Long | 1 |
| J4016A | Dual-Reach Jaw | 3 |
| J4017 | Long Narrow Jaw | 3 |
| J4018 | Cap Screw Jaw | 3 |
| J4021S | Spring Clip | 3 |
| J4011S | Spring Clip | 3 |
| J4331 | Bearing Separator, 2-13/32" Capacity | 1 |
| J4333A | Bearing Separator, 6" Capacity | 1 |
| J4040 | Step Plate Adapter Set | 1 |
| J4040-12 | Step Plate, 2-1/8" Bore | 1 |
| J4040-13 | Step Plate, 2-1/4" Bore | 1 |
| J4040-14 | Step Plate, 2-3/8" Bore | 1 |



PROTO-EASE™ MASTER PULLER SET (WITH BOX)

Product #: **J4235B**



- › Covers most maintenance operations using standard pullers.
- › Contains components necessary to assemble all full-interchange system pullers except Proto® Press-N-Pull™ Pullers.
- › Weight (lbs): 93.00



| Contents | Description | Qty. |
|----------|-------------------------------|------|
| J4205B | Slotted Crossarm, 2-Way/3-Way | 1 |
| J4022T | Standard Detachable Tip | 1 |
| J4205S | Forcing Screw | 1 |
| J4005C | Cap Screw, 3/8"-24 UNF x 3" | 3 |
| J4205E | Cap Screw, 3/8"-16 UNC x 4" | 3 |
| J4028 | Cap Screw, 3/8"-16 UNC x 3" | 3 |
| J4206SC | Slotted Crossarm, 2-Way | 1 |
| J4250B | 2 Jaw Yoke | 1 |
| J4255B | 3 Jaw Yoke | 1 |
| J4056-2 | Inside Jaw, 2" Reach | 3 |
| J4056-4 | Reversible Jaw, 4" Reach | 3 |
| J4056-6 | Reversible Jaw, 6" Reach | 3 |
| J4250N | Reversible Adjusting Nut | 1 |
| J4056PN | Jaw Pivot Pin | 3 |
| J4260H | 2-1/2 lbs. Slide Hammer | 1 |
| J4260R | T-Handle Slide Rod, 24" Long | 1 |
| J4055H | 5 lbs. Slide Hammer | 1 |
| J4275R | Short Slide Rod | 1 |
| J4277B | Rear Axle Flange Foot | 1 |
| J4256S | Inside Hook Jaw | 1 |
| J4280 | Set Puller Blind Bearing | 1 |

| Contents | Description | Qty. |
|----------|--------------------------------------|------|
| J4211BA | Adjustable Jaw Block Assembly | 3 |
| J4026A | Dual-Reach Jaw | 3 |
| J4027 | Narrow Jaw | 3 |
| J4208CA | 2-Way/3-Way Crossarm | 1 |
| J4231A | Adjustable Jaw Block Assembly | 3 |
| J4012T | Standard Tip | 1 |
| J4225S | Forcing Screw | 1 |
| J4226CA | 2-Way Crossarm, 11" Long | 1 |
| J4227CA | 3-Way Crossarm, 11" Long | 1 |
| J4016A | Dual-Reach Jaw | 3 |
| J4017 | Long Narrow Jaw | 3 |
| J4018 | Cap Screw Jaw | 3 |
| J4021S | Spring Clip | 3 |
| J4011S | Spring Clip | 3 |
| J4331 | Bearing Separator, 2-13/32" Capacity | 1 |
| J4333A | Bearing Separator, 6" Capacity | 1 |
| J4040 | Step Plate Adapter Set | 1 |
| J4040-12 | Step Plate, 2-1/8" Bore | 1 |
| J4040-13 | Step Plate, 2-1/4" Bore | 1 |
| J4040-14 | Step Plate, 2-3/8" Bore | 1 |
| J9969-NA | Steel Storage Box | 1 |



OPERATIONAL FEATURES - 6 TON PROTO-EASE™ CONE PULLERS

Forcing screws should be easy to turn—and most are—when the load is fairly light. But tough pulling jobs are a different story. Most screws tighten up when the going gets rough, resulting in far less output than you apply. Why? Because there's frictional resistance. The thread and threaded hole are fighting each other all the way. Not with Proto®! We've got Acme threads to increase your muscle power. Acme is the thread with a long-lasting reputation for easy turning and smooth-as-silk performance.

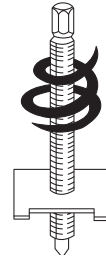

Since the adjusting cone threads on the crossblock and not onto the forcing screw, it is isolated from the torque of the screw. This means there's no unwanted jaw tightening.

Go ahead—turn down the screw. Apply all the pressure you need. You won't change the set of the jaws. You can hold onto a gear, bushing or sleeve with unheard of precision and maximum control. No more stretching, scoring or crushing. Unwanted tightening is a thing of the past.

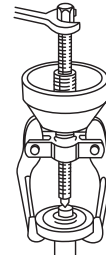
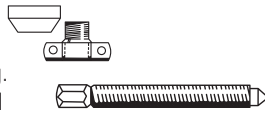

Reversing jaws from an external pull (A) to an internal pull (B) used to be a problem. It was tedious and took time. No more! Now Proto® threads the cone on the crossblock. A few turns and it's off. Flip it and a few turns puts it on again. Reversing the jaws is even faster. Pop the pivot pins out, turn the jaws and pop the pins in again. The screw? It stays put. You're ready to pull.

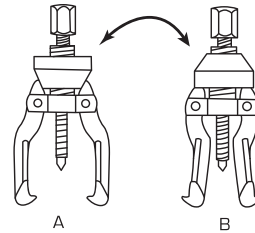

Jaws are configured to cam smoothly within the adjusting cone resulting in smoother jaw action and wider jaw spread.

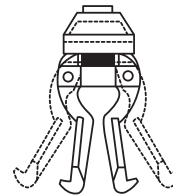

Switching from a forcing screw to a slide hammer used to be a problem. You had to unscrew the forcing screw from BOTH crossblock and adjusting cone and this caused you to lose the set of your jaws. Then you had to "hook-up" all over again. No more! Out comes the screw and in goes the slide rod. You've got a slide hammer puller. The adjusting cone? It stays put...on the crossblock.



Now, both slide rods mate up with ALL attachments... So does the forcing screw. They're all threaded alike. Slide rods, forcing screws and attachments...ALL threaded 5/8"-12 Acme!

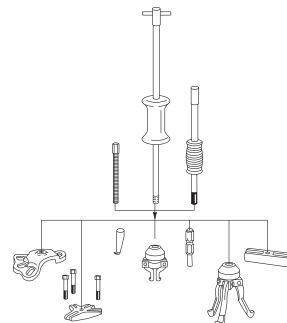

6 TON 2-WAY CONE PULLER SET

Product #: J4250

- › Reach: 4" – Spread: 5".
- › Weight (lbs): 2.43

| Contents | Description | Qty. |
|----------|--------------------------|------|
| J4022T | Standard Detachable Tip | 1 |
| J4056-4 | Reversible Jaw, 4" Reach | 2 |
| J4056PN | Jaw Pivot Pin | 2 |
| J4205S | Forcing Screw | 1 |
| J4250B | 2 Jaw Yoke | 1 |
| J4250N | Reversible Adjusting Nut | 1 |



6 TON 2-WAY CONE PULLER SET

Product #: J4251

- › Reach: 4" and 6" – Spread: 5" and 7".
- › Weight (lbs): 2.96

| Contents | Description | Qty. |
|----------|--------------------------|------|
| J4022T | Standard Detachable Tip | 1 |
| J4056-4 | Reversible Jaw, 4" Reach | 2 |
| J4056-6 | Reversible Jaw, 6" Reach | 2 |
| J4056PN | Jaw Pivot Pin | 2 |
| J4205S | Forcing Screw | 1 |
| J4250B | 2 Jaw Yoke | 1 |
| J4250N | Reversible Adjusting Nut | 1 |



6 TON PROTO-EASE™ 2-WAY/3-WAY CONE PULLER SET

Product #: J4252

- › Reach: 4" and 6" – Spread: 5" and 7".
- › Weight (lbs): 4.12

| Contents | Description | Qty. |
|----------|--------------------------|------|
| J4022T | Standard Detachable Tip | 1 |
| J4056-4 | Reversible Jaw, 4" Reach | 3 |
| J4056-6 | Reversible Jaw, 6" Reach | 3 |
| J4056PN | Pivot Pin | 3 |
| J4205S | Forcing Screw | 1 |
| J4250B | 2 Jaw Yoke | 1 |
| J4255B | 3 Jaw Yoke | 1 |
| J4250N | Reversible Adjusting Nut | 1 |



6 TON PROTO-EASE™ 3-WAY CONE PULLER SET**Product #: J4255**

- › Reach: 4" – Spread: 5".
- › Weight (lbs): 2.59

| Contents | Description | Qty. |
|----------|--------------------------|------|
| J4022T | Standard Detachable Tip | 1 |
| J4056-4 | Reversible Jaw, 4" Reach | 3 |
| J4056PN | Pivot Pin | 3 |
| J4205S | Forcing Screw | 1 |
| J4255B | 3 Jaw Yoke | 1 |
| J4250N | Reversible Adjusting Nut | 1 |

**6 TON 3-WAY CONE PULLER****Product #: J4257**

- › Reach: 6" – Spread: 7".
- › Weight (lbs): 2.50

| Contents | Description | Qty. |
|----------|--------------------------|------|
| J4022T | Standard Detachable Tip | 1 |
| J4056-6 | Reversible Jaw, 6" Reach | 3 |
| J4056PN | Jaw Pivot Pin | 3 |
| J4205S | Forcing Screw | 1 |
| J4255B | 3 Jaw Yoke | 1 |
| J4250N | Reversible Adjusting Nut | 1 |





OPERATIONAL FEATURES
6 TON PROTO-EASE™ WIDE PULLERS

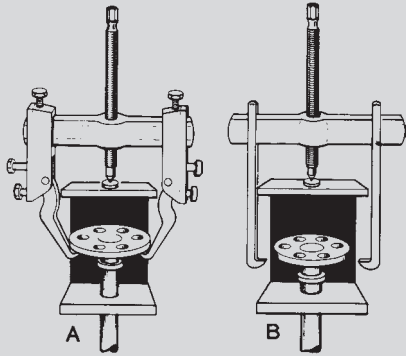

Adjustable jaws (A) reach around obstructions to grip parts inaccessible to straight jaws (B)

TYPICAL APPLICATIONS
NO. J4217 PROTO-EASE™
6 TON PROTO-EASE™ 2-WAY/3-WAY ADJUSTABLE JAW PULLER

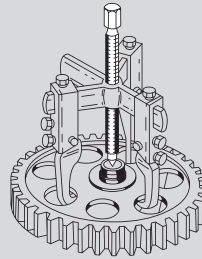

Puller is used to pull a gear off a hub. Gear has holes positioned close to the hub so medium size pullers can get a grip without damaging the case-hardened gear teeth. To avoid damage, when pulling gears in particular, a 3-way puller is generally preferred to a 2-way puller.

Adjustable jaws (C) have greater reach capabilities than straight jaws (D)



Puller is used to remove the pilot bearing from a transmission output shaft (adjustable jaws are shown used as straight jaws since no angle-of-grip adjustment is required). Each adjustable jaw block assembly slides along the crossarm for positioning—just as straight jaws, but with an important difference: Lock screw on top of jaw blocks secures each jaw assembly for a safe, slip-resistant grip.

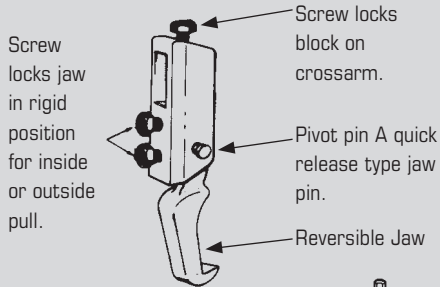

Jaws slide into place along crossarm and may be positioned at unequal distances from the forcing screw for unusual pulling applications.

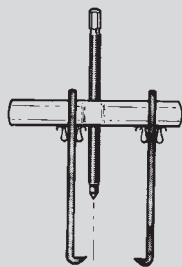

6 Ton Straight Jaws

The 6 ton wide puller shown below accepts all 3 ton and 6 ton jaws—adjustable and straight.

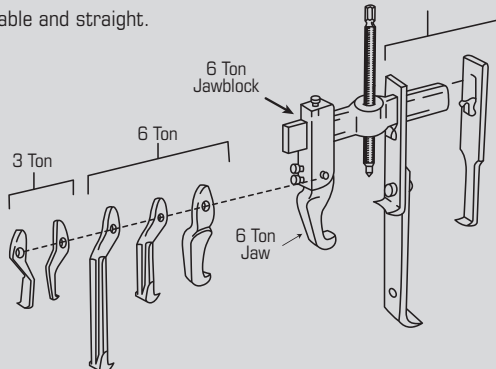

NOTE: Tonnage ratings do not apply when: 1) using jaw blocks with lock screws facing inboard (see drawing C above), 2) jaw angle exceeds 7° or 3) lighter adjustable jaws are used in heavier jaw blocks.

6 TON PROTO-EASE™ 2-WAY/3-WAY ADJUSTABLE JAW PULLER

Product #: **J4217**

- › Reach: 4-1/2" – Spread: 8"
- › Weight (lbs): 6.25

| Contents | Description | Qty. |
|----------|------------------------------|------|
| J4022T | Standard Detachable Tip | 1 |
| J4056PN | Pivot Pin | 3 |
| J4205S | Forcing Screw | 1 |
| J4208CA | 2-Way/3-Way Crossarm | 1 |
| J4209JB | Jaw Block | 3 |
| J4209LS | Lock Screw | 9 |
| J4210RJ | Reversible Jaw, 4-1/2" Reach | 3 |

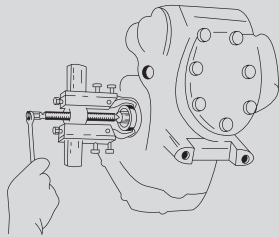
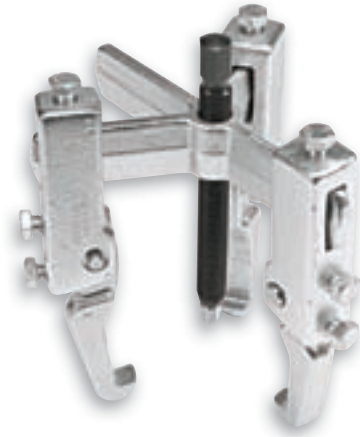

The bearing housing of this air conditioning compressor has been removed, exposing to view the crankshaft bearing, a part that frequently requires replacement—often calling for additional compressor disassembly to remove. Further disassembly can be avoided, however, with a pair of jaws strong enough, yet slim enough to slip between the bearing and compressor walls. The 6 ton puller is equipped with No. J4210SJ short jaws, specially shaped for minimum clearance pulling situations like this. Although rated at a maximum of 3 tons, these jaws are best used with a 6 ton puller assembly, as shown. In extremely limited access situations, these jaws can be inserted sideways, individually, then turned back to standard pulling position before hook-up with sliding jaw blocks.

6 TON PROTO-EASE™ 2-WAY STRAIGHT JAW PULLER

Product #: **J4212SJB**

- › Reach: 2" and 4" – Spread: 6"
- › Weight (lbs): 4.87

| Contents | Description | Qty. |
|----------|-------------------------|------|
| J4021S | Standard Spring Clip | 2 |
| J4022T | Standard Detachable Tip | 1 |
| J4026A | Dual Reach Jaw | 2 |
| J4027 | Narrow Jaw | 2 |
| J4205S | Forcing Screw | 1 |
| J4206CA | 2-Way Crossarm | 1 |
| J4029 | Steel Storage Box | 1 |





6 TON 2-WAY STRAIGHT JAW PULLER SET

Product #: J4212SJ

- › Reach: 2" and 4" – Spread: 6"
- › Weight (lbs): 3.19

| Contents | Description | Qty. |
|----------|-------------------------|------|
| J4021S | Spring Clip | 2 |
| J4022T | Standard Detachable Tip | 1 |
| J4026A | Dual Reach Jaw | 2 |
| J4027 | Narrow Jaw | 2 |
| J4205S | Forcing Screw | 1 |
| J4206CA | 2-Way Crossarm | 1 |



6 TON JAW BLOCK ASSEMBLY

Product #: J4211BA

- › Weight (lbs): 1.37

| Contents | Description | Qty. |
|----------|------------------------------|------|
| J4056PN | Jaw Pivot Pin | 1 |
| J4209JB | Jaw Block | 1 |
| J4209LS | Lock Screw | 3 |
| J4210RJ | Reversible Jaw, 4-1/2" Reach | 1 |



6 TON PROTO-EASE™ 2-WAY ADJUSTABLE JAW PULLER SET

Product #: J4212MJ

- › Reach: 7-3/4" – Spread: 11"
- › Weight (lbs): 5.12

| Contents | Description | Qty. |
|----------|------------------------------|------|
| J4022T | Standard Detachable Tip | 1 |
| J4056-6 | Reversible Jaw, 6" Reach | 2 |
| J4056PN | Pivot Pin | 2 |
| J4205S | Forcing Screw | 1 |
| J4206CA | 2-Way Crossarm | 1 |
| J4209JB | Jaw Block | 2 |
| J4209LS | Lock Screw | 6 |
| J4210RJ | Reversible Jaw, 4-1/2" Reach | 2 |
| J4210SJ | Short Jaw | 2 |

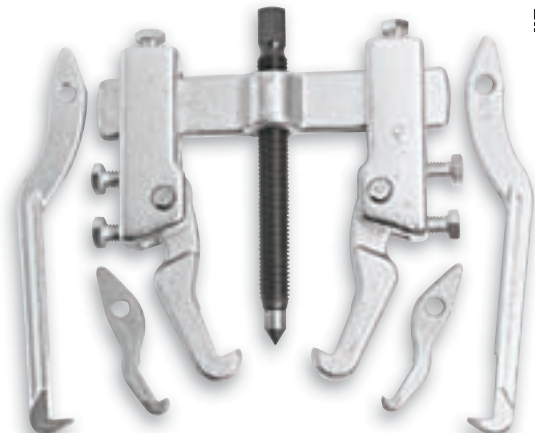

10 TON PROTO-EASE™ 3-WAY ADJUSTABLE JAW PULLER**Product #: J4233E**

- › Reach: 5" – Spread: 12".
- › Weight (lbs): 10.68

| Contents | Description | Qty. |
|----------|---------------------------------|------|
| J4012T | Standard Tip | 1 |
| J4056PN | Pivot Pin | 3 |
| J4225S | Forcing Screw | 1 |
| J4227CA | 3-Way Crossarm, 11" Long | 1 |
| J4229JB | Jaw Block | 3 |
| J4229LS | Lock Screw, 7/16"-14 UNC x 3/4" | 9 |
| J4230RJ | Adjustable Reversible Jaw | 3 |
| J4019 | Steel Storage Box | 1 |

**10 TON PROTO-EASE™ 2-WAY ADJUSTABLE JAW PULLER****Product #: J4232E**

- › Reach: 5" – Spread: 12".
- › Weight (lbs): 7.81

| Contents | Description | Qty. |
|----------|---------------------------------|------|
| J4012T | Standard Tip | 1 |
| J4056PN | Pivot Pin | 2 |
| J4225S | Forcing Screw | 1 |
| J4226CA | 2-Way Crossarm, 11" Long | 1 |
| J4229JB | Jaw Block | 2 |
| J4229LS | Lock Screw, 7/16"-14 UNC x 3/4" | 6 |
| J4230RJ | Adjustable Reversible Jaw | 2 |

**10 TON JAW BLOCK ASSEMBLY****Product #: J4231A**

- › Weight (lbs): 2.00

| Contents | Description | Qty. |
|----------|------------------------------|------|
| J4056PN | Jaw Pivot Pin | 1 |
| J4209JB | Jaw Block | 1 |
| J4209LS | Lock Screw | 3 |
| J4210RJ | Reversible Jaw, 4-1/2" Reach | 1 |

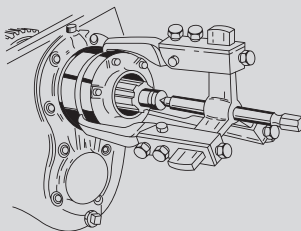

Puller is used to remove a truck input shaft's entire bearing retainer assembly. Three heavy-duty adjustable jaws (No. J4230RJ) grip assembly behind the front bearing cap while the 10 ton forcing screw bears down on the input shaft. A step plate adapter, No. J4040-2, is placed between the forcing screw tip and the input shaft to prevent damage to shaft and screw tip.



10 TON 2-WAY STRAIGHT JAW PULLER SET

Product #: J4234

- › Reach: 2-15/16", 4-11/16" and 7-1/8" (18" with jaws bolted together) – Spread: 10".
- › Weight (lbs): 11.50

| Contents | Description | Qty. |
|----------|--------------------------|------|
| J4011S | Spring Clip | 2 |
| J4012T | Detachable Tip | 1 |
| J4016A | Dual Reach Jaw | 2 |
| J4017 | Long Narrow Jaw | 2 |
| J4018 | Cap Screw Jaw | 2 |
| J4225S | Forcing Screw | 1 |
| J4226CA | 2-Way Crossarm, 11" Long | 1 |



10 TON 2-WAY STRAIGHT JAW PULLER SET

Product #: J4238

- › Reach: 2-15/16", 4-11/16" and 7-1/8" (18" with jaws bolted together) – Spread: 10".
- › Weight (lbs): 8.37

| Contents | Description | Qty. |
|----------|--------------------------|------|
| J4011S | Spring Clip | 2 |
| J4012T | Detachable Tip | 1 |
| J4016A | Dual Reach Jaw | 2 |
| J4018 | Cap Screw Jaw | 2 |
| J4225S | Forcing Screw | 1 |
| J4226CA | 2-Way Crossarm, 11" Long | 1 |



10 TON 2-WAY STRAIGHT JAW PULLER SET

Product #: J4232

- › Reach: 4-11/16" and 7-1/8" – Spread: 10".
- › Weight (lbs): 6.75

| Contents | Description | Qty. |
|----------|--------------------------|------|
| J4011S | Spring Clip | 3 |
| J4012T | Detachable Tip | 1 |
| J4016A | Dual Reach Jaw | 2 |
| J4225S | Forcing Screw | 1 |
| J4226CA | 2-Way Crossarm, 11" Long | 1 |



OPERATIONAL FEATURES — 10 TON PROTO-EASE™ PULLERS

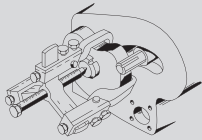

Proto-Ease™ No. J4233E 10 Ton 3-Way Adjustable Jaw Puller. Adapts easily to the job of pulling a cam from a shaft. Jaws are positioned asymmetrically on all three arms to accommodate the cam's irregular shape. Whether straight jaw or adjustable jaw, Proto-Ease™ pullers mean maximum adaptability to any pulling situation.

A J4232E Adjustable Jaw Puller clears a bearing splitter bridge to grip the truck rear axle bearing behind it.

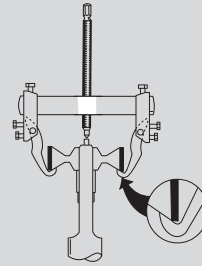
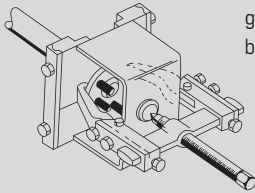

Proto-Ease™ No. J4232E 10 Ton 2-Way Adjustable Jaw Puller, shown at left pulling a gear without actually touching or in any way damaging the case hardened outer face of the gear. The jaws are locked in place and will not contract or squeeze together as pressure is applied. Precision, damage free pulling requires precision jaw positioning. Proto-Ease™ gives you that precision!

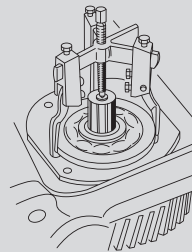

An Adjustable Jaw Puller can grip an object larger in diameter than the length of its crossarm. The trick is to reverse the jaw blocks so the lock screws face inboard. Doing this can add as much as 27° more jaw spread for external pulls—30° more for internal pulls, with a corresponding reduction in load capacity. (See note below).

NOTE: Tonnage ratings do not apply when: 1) using jaw blocks with lock screws facing inboard (see above illustration), 2) jaw angle exceeds 7° or 3) lighter adjustable jaws are used in heavier jaw blocks

10 TON PROTO-EASE™ 3-WAY STRAIGHT JAW PULLER

Product #: **J4233SJ**

- › Reach: 4-11/16" and 7-1/8" – Spread: 10".
- › Weight (lbs): 9.00

| Contents | Description | Qty. |
|----------|--------------------------|------|
| J4011S | Spring Clip | 3 |
| J4012T | Standard Tip | 1 |
| J4016A | Dual Reach Jaw | 3 |
| J4225S | Forcing Screw | 1 |
| J4227CA | 3-Way Crossarm, 11" Long | 1 |
| J4019 | Steel Storage Box | 1 |

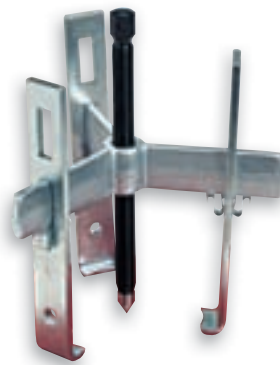

10 TON PROTO-EASE™ 2-WAY STRAIGHT JAW PULLER SET

Product #: **J4234B**

- › Reach: 2-15/16", 4-11/16" and 7-1/8" (18" with jaws bolted together) – Spread: 10".
- › Weight (lbs): 15.37

| Contents | Description | Qty. |
|----------|--------------------------|------|
| J4011S | Spring Clip | 2 |
| J4012T | Standard Tip | 1 |
| J4016A | Dual Reach Jaw | 2 |
| J4017 | Long Narrow Jaw | 2 |
| J4018 | Cap Screw Jaw | 2 |
| J4225S | Forcing Screw | 1 |
| J4226CA | 2-Way Crossarm, 11" Long | 1 |
| J4019 | Steel Storage Box | 1 |

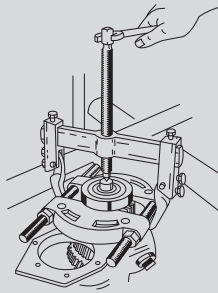
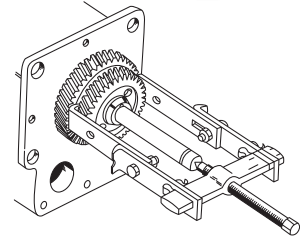

Puller is used with a separator to remove a truck countershaft's rear bearing. Notice separator is positioned so bearing rests on flat side of plates, while gear beneath nests within plate concavity. Note too, how heavy-duty 10 ton adjustable jaws (No. J4230RJ) "cradle" the separator's threaded rods for maximum gripping surface. No. J4229JB jawblocks must be positioned at the ends of the crossarm to produce this "cradling" effect.

10 TON PROTO-EASE™ 2-WAY STRAIGHT JAW PULLER SET

Product #: **J4232SJ**

- › Reach: 4-11/16" and 7-1/8" (12" with jaws bolted together) – Spread: 10".
- › Weight (lbs): 8.68

| Contents | Description | Qty. |
|----------|--------------------------|------|
| J4011S | Spring Clip | 2 |
| J4012T | Standard Tip | 1 |
| J4015 | Short Jaw | 2 |
| J4016A | Dual Reach Jaw | 2 |
| J4225S | Forcing Screw | 1 |
| J4226CA | 2-Way Crossarm, 11" Long | 1 |



NOTE: Puller removes a gear with two sets of straight jaws, bolted together for extra reach. Set comes with two sets of jaws — Jaw No. J4015 has a 4-11/16" reach and No. J4016A has a 7-1/8" reach. Bolted together they easily clear the 8" long gear shaft.



OPERATIONAL FEATURES — 10 TON PRESS-N-PULL™ PULLERS

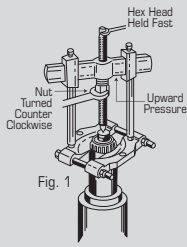

Fig. 1

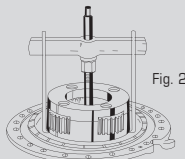

Fig. 2

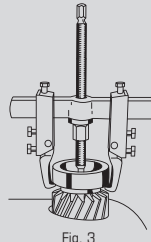
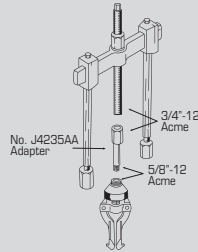

Fig. 3

With Press-N-Pull™ Pullers the forcing screw is not turned, as with a regular puller. Instead, the forcing screw's hex head is held fast, while the forcing nut is turned counterclockwise, forcing the smooth bored crossarm up. With it comes the object being pulled, in this case a bearing, gripped by a separator (Fig. 1). Since Press-N-Pull™ Pullers smooth bored crossarms accept regular jaws, whether straight jaws (Fig. 2) or adjustable jaws (Fig. 3), every Press-N-Pull™ puller can double as a regular puller. It's like having two pullers in one.



No. J4235AA

Male Acme Thread Screw Adapter Permits Press-N-Pull™ forcing screw hook up with an Acme threaded 6 ton puller—in this case, with a 6 ton No. J4250.

No. J4235UA

A Second Screw Adapter, has 5/8"-18 UNF male thread for Press-N-Pull™ forcing screw hook up with all three female adapters plus all three male adapters, used to hook up with internally and externally threaded shafts.

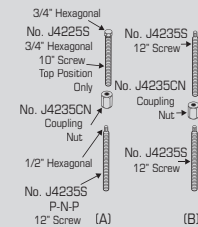

No. J4235CN

Forcing Screw Coupling Nut—has 3/4"-12 Acme thread—same as 10 ton forcing screws. Couples 10 ton 10" forcing screw with Press-N-Pull™ 12" screw (A). Also joins two 10 ton Press-N-Pull™ 12" screws for maximum forcing screw extension (B).

TYPICAL APPLICATIONS — 10 TON PRESS-N-PULL™ PULLERS

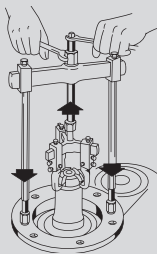

Medium duty 6 ton adjustable jaws are used here to pull an output shaft from the rear of a transmission case. Jaws are arranged for an external pull—tips facing in. Press-N-Pull™ 2-way crossarm is unthreaded, so forcing screw rises straight up—without revolving—when nut on top of crossarm is turned down.

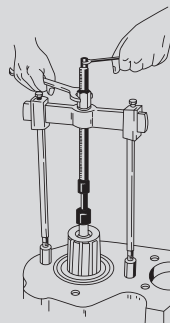

This pressed-in transmission output shaft has a threaded end to hook up with, but the Press-N-Pull™ forcing screw requires two adapters to accomplish this. First, a J4235UA male screw adapter is attached to the forcing screw. To this is added a J4240-14F female adapter with internal thread (7/8"-14 UNF) to mate up with the output shaft's threaded end. Since the forcing screw travels straight up—without revolving—there's no danger of accidental unthreading—also no unnecessary rotational resistance during pulling.

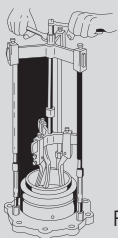

Fig. 1

To remove a cross bearing cup a Proto-Ease™ Press-N-Pull™ 3-way puller is hooked up to a 6 ton 3-way puller with 6" jaws (Fig. 1). Since it's an internal pull, jaws are reversed—tips out. A J4235AA screw adapter joins the forcing screw to the 6 ton crossarm. Three J4240-08F leg adapters connect medium legs to short legs for necessary clearance. Pressure pads protect short leg ends.

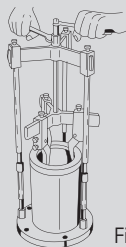
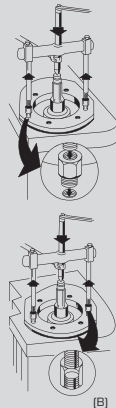

Fig. 2

Heavy-duty 10 ton adjustable jaws are also reversed in Fig. 2 for an internal pull—tips out—to pull the sleeve from an industrial cylinder. Jaws belong to No. J4233E 10 ton 3-way puller—which threads directly onto the Press-N-Pull™ forcing screw. No need for a screw adapter—both are threaded 3/4"-12 Acme.



(B)

Since both of these Press-N-Pull™ 2-way pullers have forcing nuts and washers positioned beneath the crossarm, downward pressure will be exerted on the screw while upward pressure will pull at the legs—which must be screwed into threaded holes or onto threaded studs by means of leg adapters. Puller A is pressing an output shaft forward, legs equipped with male leg adapters. Puller B is pressing a driveshaft out of a gearbox, legs equipped with female leg adapters.

10 TON PRESS-N-PULL™ 3-LEG PULLER SET

Product #: **J4293SP-STK**

- › Reach: 22" – Spread: 11".
- › Weight (lbs): 35.24

| Contents | Description | Qty. |
|-----------|---|------|
| J4012T | Standard Tip | 1 |
| J4229LS | Lock Screw, 7/16"-14 UNC x 3/4" | 3 |
| J4236CA | 2-Way Crossarm | 1 |
| J4237CA | 3-Way Crossarm | 1 |
| J4235S | Forcing Screw | 1 |
| J4235AA | Adapter, 3/4"-12 Female x 5/8" Male Acme | 1 |
| J4235UA | Adapter, 3/4"-12 Female Acme x 5/8" 18 UNF Male | 1 |
| J4235CN | Coupling Nut, 3/4"-12 Acme | 1 |
| J4236N | Forcing Nut | 1 |
| J4236W | Thrust Washer | 1 |
| J4239SB | Slideblock | 3 |
| J4240SL | Short Leg | 3 |
| J4240L | Medium Leg | 3 |
| J4240P | Leg Pressure Pad | 3 |
| J4240-08F | Adapter, 5/8" x 1/2" Female | 3 |
| J4240-08M | Adapter, 5/8" x 1/2" Male | 3 |
| J4240-12F | Adapter, 5/8" x 3/4" Female | 3 |
| J4240-12M | Adapter, 5/8" x 3/4" Male | 3 |
| J4240-14F | Adapter, 5/8" x 7/8" Female | 3 |
| J4240-14M | Adapter, 5/8" x 7/8" Male | 3 |
| J4332 | Bearing Separator, 4-3/8" Capacity | 1 |



10 TON PRESS-N-PULL™ 2-LEG PULLER

Product #: **J4242**

- › Reach: 14" – Spread: 11".
- › Weight (lbs): 9.18

| Contents | Description | Qty. |
|----------|---------------------------------|------|
| J4012T | Standard Tip | 1 |
| J4229LS | Lock Screw, 7/16"-14 UNC x 3/4" | 2 |
| J4235S | Forcing Screw | 1 |
| J4236CA | 2-Way Crossarm | 1 |
| J4236N | Forcing Nut | 1 |
| J4236W | Thrust Washer | 1 |
| J4239SB | Slideblock | 2 |
| J4240L | Medium Leg | 2 |
| J4240P | Leg Pressure Pad | 2 |



OPERATIONAL FEATURES — 6 TON PROTO-EASE™ SLIDE HAMMER PULLERS

Both long and short slide rods mate up with all 6 ton components. They're all threaded alike.

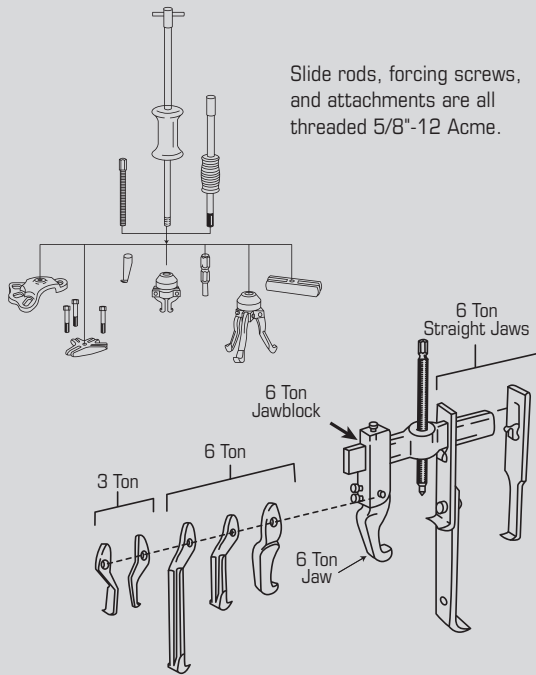

Slide rods, forcing screws, and attachments are all threaded 5/8"-12 Acme.

ROLLED ACME VS VEE AND BUTTRESS THREADS A smaller flank angle requires less torque.



ROLLED ACME

STANDARD VEE

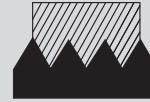

ROLLED ACME
THREAD

VEE THREAD

BUTTRESS
THREAD

- › Transmits power more efficiently.
- › Lower frictional resistance.
- › Durable.

- › High frictional resistance.
- › Easily nicked.

- › Load can be applied in one direction only.
- › Users often insert screw in wrong direction.
- › Easily nicked.

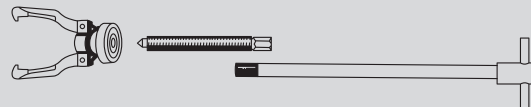

Switching from a forcing screw to a slide hammer used to be a problem. You had to unscrew with forcing screw from BOTH crossblock and adjusting cone and this caused you to lose the set of your jaws. Then you had to "hook-up" all over again. No more! Out comes the screw and in goes the slide rod. You've got a slide hammer puller. The adjusting cone? It stays put...on the crossblock.

TYPICAL APPLICATIONS — 6 TON PROTO-EASE™ SLIDE HAMMER PULLERS

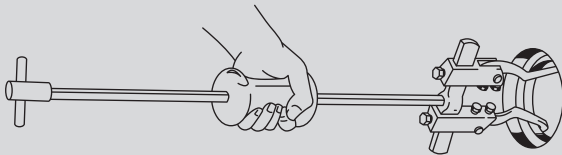

A 6 ton slide rod with 5 lbs. hammer is threaded into a 6 ton 2-way adjustable puller to "shock" a bearing cup out. The jawblocks are reversed for greater jaw spread.

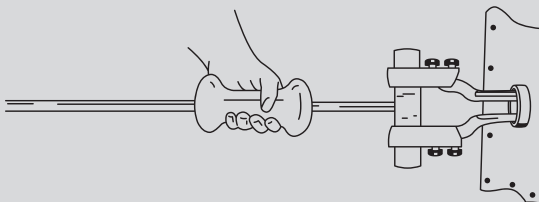

The same puller is used to "shock-out" an oil seal from its housing. Here, both jawblocks are positioned in the conventional pulling position—lock-screws outboard, while the jaws remain reversed, tips out.

10-WAY PROTO-EASE™ ADVANTAGE SLIDE HAMMER PULLER SET

Product #: J5040



- › Slide hammer puller set packaged in a convenient plastic blow-molded carrying/storage case.
- › Weight (lbs): 25.00

| Description | Qty. |
|-----------------------------------|------|
| Hex Jam Nut (5/16"-24) | 3 |
| Hex Jam Nut (5/8"-18) | 1 |
| Hex Head Cap Screw (5/16"-24) | 3 |
| Puller Head | 1 |
| Adjusting Cone | 1 |
| Forcing Screw | 1 |
| 2-Way Crossarm | 1 |
| Pulling Hook | 1 |
| Pulling Adapter-Machine | 1 |
| Pilot Bearing Puller Jaw | 3 |
| 5 lbs. Slide Hammer | 1 |
| Puller Arm | 1 |
| Medium Puller Jaw | 3 |
| Long Puller Jaw | 3 |
| Self Tapping Screw | 1 |
| Adapter For Adjustable Jaw Wrench | 1 |
| Retainer | 1 |
| Shank and Tee Bar Assembly | 1 |
| Sleeve (5/8"-18) | 1 |
| Forcing Screw | 1 |
| Front Hub Remover | 1 |
| Blow-Molded Case | 1 |



REVERSIBLE JAW SLIDE HAMMER PULLER

Product #: J5049



- › Versatile puller which will accomplish many pulling jobs involving gears, bearings, outer races, grease retainers, oil seals, etc.
- › Either two or three puller jaws may be used to handle "inside" pulling jobs such as bearing cups and outer racers, as well as regular "outside" pulling jobs.
- › The 5 lbs. slide hammer can be removed and used independently.
- › Weight (lbs): 11.00
- › Overall Length: 27".



| 2-Jaw Spread | | | | 3-Jaw Spread | | | |
|--------------|--------|---------|--------|--------------|--------|---------|--------|
| Inside | | Outside | | Inside | | Outside | |
| Min. | Max. | Min. | Max. | Min. | Max. | Min. | Max. |
| 1-1/4" | 3-1/2" | 1" | 4-1/2" | 1-1/2" | 4-1/4" | 1-1/2" | 4-1/2" |

6 TON PROTO-EASE™ 2-WAY PILOT BEARING/SMALL BUSHING PULLER

Product #: **J4275**

- › Reach: 2" – Spread: 5/8" to 2-1/2" inside.
- › Weight (lbs): 5.18

| Contents | Description | Qty. |
|----------|--------------------------|------|
| J4056-2* | Inside Jaw, 2" Reach | 2 |
| J4056PN | Pivot Pin | 2 |
| J4250B | 2-Jaw Yoke | 1 |
| J4250N | Reversible Adjusting Nut | 1 |
| J4260H | 2-1/2 lbs. Slide Hammer | 1 |
| J4275R | Short Slide Rod | 1 |

*Jaw capacity: 3 tons



BEARING SEPARATOR COMBO PACK

Product #: **J5041**

- › This combo pack contains four of the most requested bearing separators plus a pulley pulling attachment.
- › A rugged organizer case is included, enabling you to keep the tools together for instant use.
- › Weight (lbs): 30.50

| Description | Qty. |
|--|------|
| Bearing Separators: | |
| 1/4" Min. - 15/16" Max. Spread | 1 |
| 1/8" Min. - 2" Max. Spread | 1 |
| 1/2" Min. - 4-5/8" Max. Spread | 1 |
| 1/2" Min. - 9" Max. Spread | 1 |
| Pulley pulling attachment with a 1-3/4" Min. - 5-7/8" Max. Spread | 1 |
| Blow-Molded Case | 1 |



PROTO-EASE™ GEAR AND BEARING SEPARATOR

Product #: **J4330**

- › Capacity: 1-13/16".
- › Weight (lbs): 0.07

| Contents | Description | Qty. |
|----------|------------------------------|------|
| J4330N | Hex Nut, 5/16"-24 UNF | 2 |
| J4330P | Separator Plate, Size #0 | 2 |
| J4330R | Cap Screw, 5/16"-24 UNF x 3" | 2 |

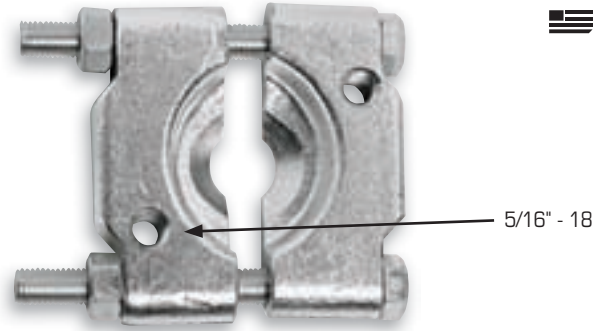

PROTO-EASE™ GEAR AND BEARING SEPARATOR

Product #: **J4331**

- › Capacity: 2-13/32".
- › Weight (lbs): 1.48

| Contents | Description | Qty. |
|----------|----------------------------------|------|
| J4331N | Hex Nut, 7/16"-20 UNF | 2 |
| J4331P | Separator Plate, Size #1 | 2 |
| J4331R | Cap Screw, 7/16"-20 UNF x 4-1/2" | 2 |

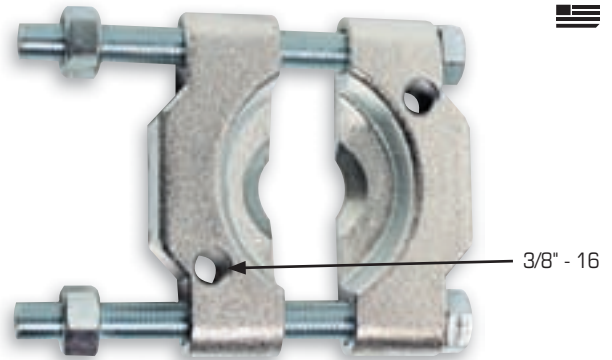

OPERATIONAL FEATURES AND TYPICAL APPLICATIONS

PROTO-EASE™ GEAR AND BEARING SEPARATORS

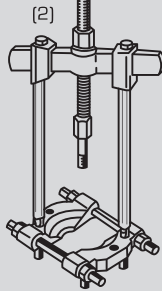
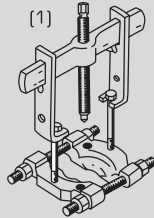
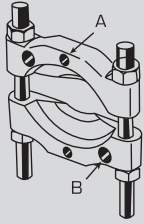

No. J4332 has two sets of drilled holes. One set (A) directly apart, has 1/2"-13 UNC thread, to accept common 1/2" cap screws—easily gripped with No. J4018 cap screw jaws (1). A second set (B), diagonally apart, has 5/8"-18 UNF threaded holes to accept Press-N-Pull™ leg ends (2).

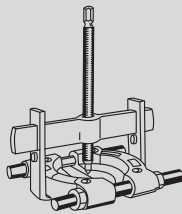
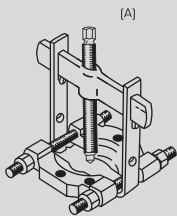

No. J4332 has two sets of drilled holes. One set (A) directly apart, has 1/2"-13 UNC thread, to accept common 1/2" cap screws—easily gripped with No. J4018 cap screw jaws (1). A second set (B), diagonally apart, has 5/8"-18 UNF threaded holes to accept Press-N-Pull™ leg ends (2).

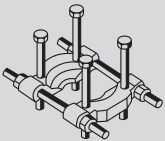

The larger separator, No. J4333 has 4-corner symmetrical jacking holes for 5/8"-18 cap screws. Permits separator action where space does not allow for puller accessories.

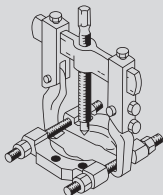

Adjustable jaws also grip separators directly—mid-point on the threaded rods. For positive grip, jaws may be angled, tips inboard, and locked in place, so as to "cradle" the rods.

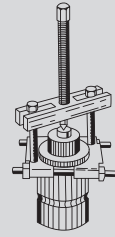

Proto-Ease™ No. J4330 separator with No. J4214 6 ton slotted crossarm puller—used to remove an electric motor commutator. The smallest of separators (size #0) has diagonally positioned threaded holes to accommodate size 5/16"-18 UNC cap screws—(Not included in the J4214 set).

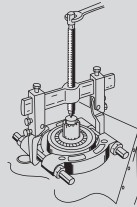

Proto-Ease™ No. J4333 separator with No. J4232E 10 ton adjustable jaw puller—used to remove the rear bearing from an output shaft. Thin, tapered separator edges fit behind bearings when space is too limited for puller jaws.

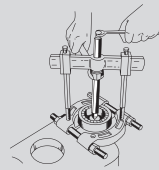

Proto-Ease™ No. J4333 separator with No. J4242 Press-N-Pull™ Puller—used to remove the rear bearing from an auxiliary countershaft. Separator plate threaded holes, and Press-N-Pull™ leg ends are threaded alike—with 5/8"-18 UNF. Hooks up fast for a positive, safe, non-slip grip.

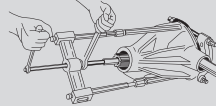

Proto-Ease™ No. J4333A separator and Press-N-Pull™ 2-way puller with medium and short legs. Used to press the pinion shaft out of a differential housing. Separator's extra long 13" threaded rods permit maximum separator plate spread—sufficient to straddle the differential housing and match the spread of Press-N-Pull™ slide blocks, extended to their maximum width along the crossarm.

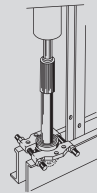

Proto-Ease™ No. J4332 separator mounted on a shop forcing press, beneath a hydraulic press ram. Used to remove the bearing from a rear axle. Ram forces axle down through the separator opening, freeing the bearing. To protect the bearing and the gear beneath it, the separator is placed so the bearing rests on the flat side of the separator plates.



PROTO-EASE™ CAP SCREW PULLERS

Proto-Ease™ No. J4214 6 ton slotted crossarm puller is used at top left to pull a gear from a crankshaft. Since both 3/8"-16x3" cap screws are threaded directly into the gear being pulled, the gear will pull off when the forcing screw's pressure is applied to the shaft. At bottom left, the same puller's cap screws are anchored on either side of an object being pushed out—in this case, a countershaft, pressed towards the rear, until it frees the front bearing.

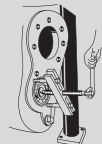

PROTO-EASE™ GEAR AND BEARING SEPARATOR

Product #: **J4332**

- › Capacity: 4-3/8".
- › Weight (lbs): 5.57

| Contents | Description | Qty. |
|----------|---------------------------|------|
| J4332N | Hex Nut, 5/8"-18 UNF | 4 |
| J4332P | Separator Plate, Size #2 | 2 |
| J4332R | Threaded Rod, 5/8"-18 UNF | 2 |

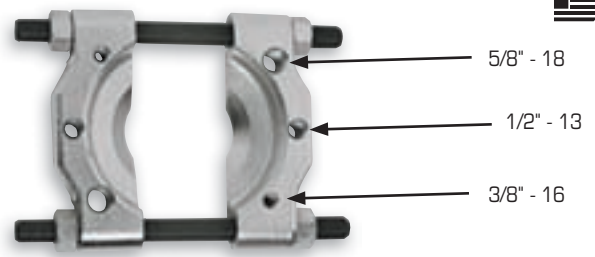

PROTO-EASE™ GEAR AND BEARING SEPARATOR

Product #: **J4333**

- › Capacity: 6".
- › Weight (lbs): 11.75

| Contents | Description | Qty. |
|----------|---------------------------------|------|
| J4333N | Hex Nut, 3/4"-16 UNF | 4 |
| J4333P | Separator Plate, Size #3 | 2 |
| J4333R | Threaded Rod, 3/4"-16 UNF x 10" | 2 |

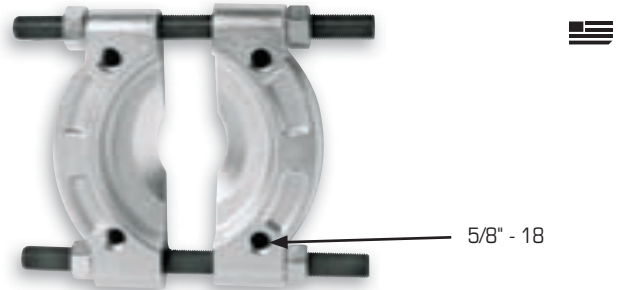

PROTO-EASE™ GEAR AND BEARING SEPARATOR

Product #: **J4333A**

- › Capacity: 6".
- › Weight (lbs): 12.50

| Contents | Description | Qty. |
|----------|---------------------------------|------|
| J4333N | Hex Nut, 3/4"-16 UNF | 4 |
| J4333P | Separator Plate, Size #3 | 2 |
| J4333AR | Threaded Rod, 3/4"-16 UNF x 13" | 2 |

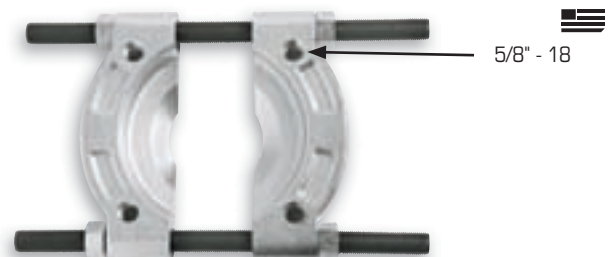

6 TON 2-WAY THREADED PART PULLER

Product #: **J4214**

- › Slotted crossarm puller used to remove a universal joint flange.
- › Span 1-1/4" to 6-1/4" — Bolt Size: 3/8"-16 UNC x 3".
- › Weight (lbs): 1.93

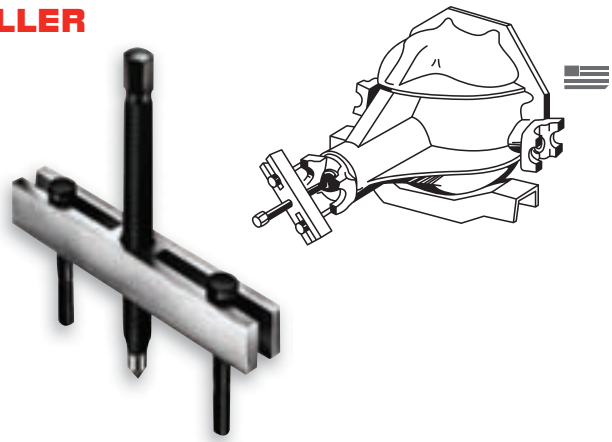

| Contents | Description | Qty. |
|----------|-----------------------------|------|
| J4022TS | Small Detachable Tip | 1 |
| J4022T | Standard Detachable Tip | 1 |
| J4205S | Forcing Screw | 1 |
| J4206SC | Slotted Crossarm 2-Way | 1 |
| J4028 | Cap Screw, 3/8"-16 UNC x 3" | 2 |

11 PIECE STEP PLATE ADAPTER SET

Product #: **J4040**

- › Includes Nos. J4040-1 thru J4040-11.
- › Overall diameter 1" to 2-7/8".
- › For bore diameter 3/4" to 2".
- › Lower Step 3/4" to 2-3/8".
- › Weight (lbs): 3.00



PULLER STEP PLATE ADAPTERS

- › Provides forcing screw base for hollow shaft applications 3/4" to 2-3/8" bore.
- › Protects bearings that are being pressed in shafts that are not center drilled.

| Product # | Small Diameter (in) | Large Diameter (in) |
|-----------------|---------------------|---------------------|
| J4040-1 | 3/4 | 1 |
| J4040-2 | 7/8 | 1-1/8 |
| J4040-3 | 1 | 1-1/4 |
| J4040-4 | 1-1/8 | 1-3/8 |
| J4040-5 | 1-1/4 | 1-5/8 |
| J4040-6 | 1-3/8 | 1-3/4 |
| J4040-7 | 1-1/2 | 1-7/8 |
| J4040-8 | 1-5/8 | 2 |
| J4040-9 | 1-3/4 | 2-1/8 |
| J4040-10 | 1-7/8 | 2-3/8 |
| J4040-11 | 2 | 2-1/2 |
| J4040-12 | 2-1/8 | 2-5/8 |
| J4040-13 | 2-1/4 | 2-3/4 |
| J4040-14 | 2-3/8 | 2-7/8 |



2 JAW GEAR PULLER, 4"

› Weight (lbs): 1.00



| Product # | Maximum Spread (in) | Maximum Reach (in) | Forcing Screw Length (in) | Thread | Rating |
|--------------|---------------------|--------------------|---------------------------|---------|--------|
| J4033 | 4 | 3-1/2 | 4-3/4 | 3/8"-24 | 2 Ton |

3 JAW GEAR PULLER, 4"

› Weight (lbs): 1.43



| Product # | Maximum Spread (in) | Maximum Reach (in) | Forcing Screw Length (in) | Thread | Rating |
|--------------|---------------------|--------------------|---------------------------|---------|--------|
| J4034 | 4 | 3-1/2 | 4-3/4 | 3/8"-24 | 2 Ton |

2 JAW GEAR PULLER, 7"

› Weight (lbs): 2.19



| Product # | Maximum Spread (in) | Maximum Reach (in) | Forcing Screw Length (in) | Thread | Rating |
|--------------|---------------------|--------------------|---------------------------|----------|--------|
| J4035 | 7 | 5-1/2 | 7 | 9/16"-20 | 5 Ton |

3 JAW GEAR PULLER, 8"

› Weight (lbs): 3.00



| Product # | Maximum Spread (in) | Maximum Reach (in) | Forcing Screw Length (in) | Thread | Rating |
|--------------|---------------------|--------------------|---------------------------|----------|--------|
| J4036 | 8 | 3-1/2 | 7 | 9/16"-20 | 5 Ton |

2 JAW GEAR PULLER, 10"

- › Weight (lbs): 4.75



| Product # | Maximum Spread (in) | Maximum Reach (in) | Forcing Screw Length (in) | Thread | Rating |
|--------------|---------------------|--------------------|---------------------------|-----------|--------|
| J4037 | 10 | 9 | 9 | 11/16"-18 | 7 Ton |

**3 JAW GEAR PULLER, 11"**

- › Weight (lbs): 6.38



| Product # | Maximum Spread (in) | Maximum Reach (in) | Forcing Screw Length (in) | Thread | Rating |
|--------------|---------------------|--------------------|---------------------------|-----------|--------|
| J4038 | 11 | 9 | 9 | 11/16"-18 | 7 Ton |

**BATTERY CABLE AND SMALL BEARING PULLER**

- › Uses toggle-type action to grip onto all standard post battery terminals.
- › Pulls small bearings and gears with 1" reach and spread.



| Product # | Weight (lbs) |
|--------------|--------------|
| J4041 | 0.65 |

**3 JAW GEAR PULLER, 7" - REVERSIBLE**

- › Weight (lbs): 2.97



| Product # | Maximum Spread (in) | Maximum Reach (in) | Forcing Screw Length (in) | Thread | Rating |
|--------------|---------------------|--------------------|---------------------------|----------|--------|
| J4046 | 7 | 5-1/2 | 7 | 9/16"-20 | 5 Ton |



3 JAW GEAR PULLER, 10" - REVERSIBLE

- › Weight (lbs): 5.93



| Product # | Maximum Spread (in) | Maximum Reach (in) | Forcing Screw Length (in) | Thread | Rating |
|--------------|---------------------|--------------------|---------------------------|-----------|--------|
| J4047 | 10 | 5-1/2 | 9 | 11/16"-18 | 7 Ton |

PULLEY PULLER

- › For removing single and two-groove pulleys from alternators and power steering pumps.
- › Two position yoke permits pulling bearings on both standard and heavy-duty alternators.

| Product # | Weight (lbs) |
|--------------|--------------|
| J4053 | 2.10 |

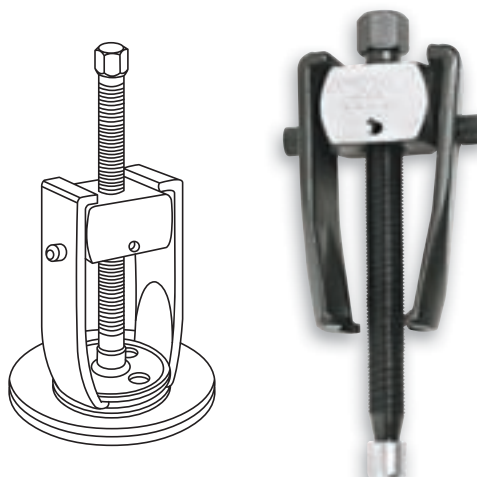

CLOSE QUARTERS PILOT BEARING PULLER

- › Designed to pull flywheel pilot bearings with inside diameters 1/2" to 1-1/2".
- › Removes bearings and bushings from starters, generators, magnetos and small electric motors.

| Product # | Weight (lbs) |
|--------------|--------------|
| J4059 | 2.30 |



JAWS

| Product # | Description | Reach (in) (A) |
|-----------------|--------------------------|----------------|
| J4056-2* | Inside Jaw, 2" Reach | 1-11/16 |
| J4056-4 | Reversible Jaw, 4" Reach | 3-3/4 |
| J4056-6 | Reversible Jaw, 6" Reach | 6-1/16 |

* 3 Ton

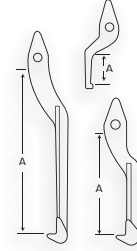

YOKE

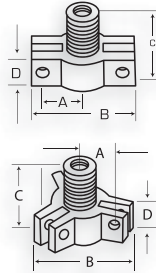

| Product # | Description | Length (in) (A) | Height (in) (C) | Height (in) (D) | Internal Thread | External Thread |
|---------------|-------------|-----------------|-----------------|-----------------|-----------------|-----------------|
| J4250B | 2-Jaw Yoke | 11/32 | 2 | 3/4 | 5/8"-12 Acme | 7/8"-14 UNF |
| J4255B | 3-Jaw Yoke | 11/32 | 2 | 3/4 | 5/8"-12 Acme | 7/8"-14 UNF |

CAP SCREW

► Weight (lbs): 2.19

| Product # | Description | Thread | Overall Length (in) |
|---------------|-------------|------------------|---------------------|
| J4205E | Cap Screw | 3/8"-16 UNC x 4" | 4 |
| J4028 | Cap Screw | 3/8"-16 UNC x 3" | 3 |
| J4005C | Cap Screw | 3/8"-24 UNF x 3" | 3 |



PIVOT PIN - PULLER REPLACEMENT PART

| Product # | Description | Pin Diameter (in) | Overall Length (in) |
|----------------|---------------|-------------------|---------------------|
| J4056PN | Jaw Pivot Pin | 5/16 | 1-11/32 |

NOTE: J4056PN is also a 10 ton part.



SLIDEBLOCK

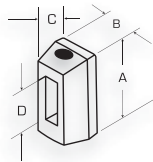

| Product # | Description | Length (in) (A) | Width (in) (B) | Depth (in) (C) | Internal Height (in) (D) |
|----------------|-------------|-----------------|----------------|----------------|--------------------------|
| J4239SB | Slideblock | 2-25/32 | 1-19/64 | 1-7/32 | 1-21/32 |



REVERSIBLE ADJUSTING NUT

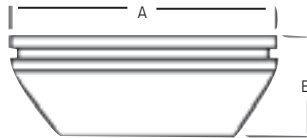

| Product # | Description | Overall Diameter (in) (A) | Height (in) (B) | Thread |
|---------------|--------------------------|---------------------------|-----------------|-------------|
| J4250N | Reversible Adjusting Nut | 2-1/2 | 1-3/32 | 7/8"-14 UNF |



SLOTTED CROSSARM (2-WAY & 3-WAY)

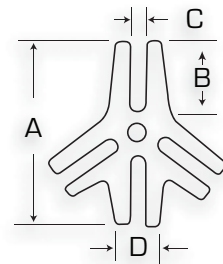

| Product # | Description | Length (in) (A) | Finger Length (in) (B) | Finger Internal Width (in) (C) | Finger External Width (in) (D) |
|---------------|--------------------------------|-----------------|------------------------|--------------------------------|--------------------------------|
| J4205B | Slotted Crossarm (2-Way/3-Way) | 5" | 1-7/8" | 25/64" | 1-1/16" |



SLOTTED CROSSARM THREADED 5/8" - 12 ACME

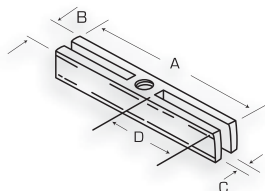

| Product # | Description | Length (in) (A) | Width (in) (B) | Slot Width (in) (C) | Slot Depth (in) (D) |
|----------------|--|-----------------|----------------|---------------------|---------------------|
| J4206SC | Slotted Crossarm Threaded 5/8"-12 Acme | 6-3/4 | 1 Sq. | 3/8 | 2-25/32 |



SLIDE HAMMER

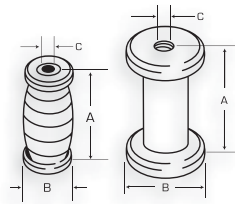

| Product # | Description | Height (in) (A) | Outside Diameter (in) (B) | Hole Diameter (in) (C) |
|-----------|-------------------------|-----------------|---------------------------|------------------------|
| J4260H | 2-1/2 lbs. Slide Hammer | 4 | 2 | 5/8 |
| J4055H | 5 lbs. Slide Hammer | 5-5/16 | 3-1/4 | 5/8 |



T-HANDLE SLIDE RODS

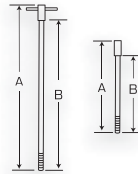

| Product # | Description | Length (in) (A) | Thread Length (in) (B) | Shaft Diameter (in) | Thread |
|-----------|-----------------|-----------------|------------------------|---------------------|--------------|
| J4260R | Slide Rod | 24 | 22 | 9/16 | 5/8"-12 Acme |
| J4275R | Short Slide Rod | 12-3/4 | 10-3/4 | 9/16 | 5/8"-12 Acme |



FORCING SCREW

► Used with No. J4280S.

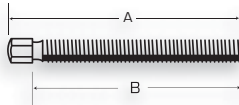

| Product # | Description | Length (in) (A) | Thread Length (in) (B) | Hex (in) | Thread | Tip |
|-----------|---------------|-----------------|------------------------|----------|---------|---|
| J4205S | Forcing Screw | 6-1/4 | 5-5/8 | 9/16 | 5/8"-12 | Drilled for Replacement Tips J4022T, J4022TS, J4222T. |
| J4225S | Forcing Screw | 10-1/4 | 9-1/4 | 3/4 | 3/4"-12 | J4012T |
| J4235S | Forcing Screw | 12 | 11-1/16 | 1/2 | 3/4"-12 | J4012T |



REAR AXLE FLANGE FOOT

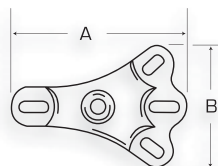

| Product # | Description | Length (in) (A) | Width (in) (B) | Shaft Diameter (in) | Thread |
|-----------|-----------------------|-----------------|----------------|---------------------|---------|
| J4277B | Rear Axle Flange Foot | 6-3/4 | 4-5/8 | 5/8 | 5/8"-12 |



BLIND BEARING PULLER

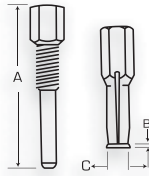

| Product # | Description | Length (in) (A) | Flange Size (in) (B) | Closed (in) (C) | Open (in) (C) |
|---------------|-------------|-----------------|----------------------|-------------------------|---------------------------|
| J4280B | Taper | 3-1/8 | — | — | — |
| | Collet | — | 3/32 | 9/16" for 9/16" I.D. | 49/64" for 11/16" I.D. |



INSIDE HOOK JAW

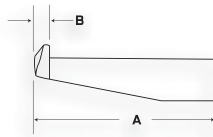

| Product # | Description | Length (in) (A) | Tip Thickness (in) (B) | Internal Thread | Use With |
|---------------|-----------------|-----------------|------------------------|-----------------|------------------|
| J4256S | Inside Hook Jaw | 2-7/8 | 3/32 | 5/8"-12 Acme | 5/8" Hole (Min.) |



SPRING CLIP

| Product # | Description | Acme Thread |
|---------------|-------------|---------------------|
| J4021S | Spring Clip | J4026A, J4027 |
| J4011S | Spring Clip | J4015, J4017, J4018 |

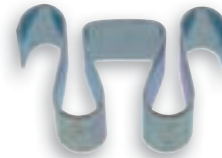

JAWS

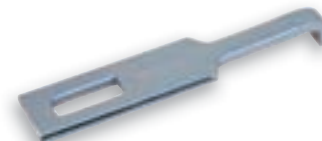
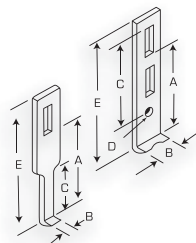

| Product # | Description | Reach (in) (A) | Width (in) (B) | Jaw Length (in) (C) | Diameter (in) (D) | Length (in) (E) |
|---------------|-----------------|----------------|----------------|---------------------|-------------------|-----------------|
| J4026A | Dual Reach Jaw | 4 and 2 | 1-1/4 | 4 | 25/64 | 6 |
| J4027 | Long Narrow Jaw | 4 | 1/2 | 2-1/16 | — | 6 |



2-WAY CROSSARM THREADED 5/8" - 12 ACME

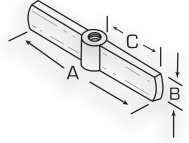

| Product # | Description | Length (in) (A) | Height (in) (B) | Radius (in) (C) | Rating |
|-----------|--------------------------------------|-----------------|-----------------|-----------------|--------|
| J4206CA | 2-Way Crossarm Threaded 5/8"—12 Acme | 7 | 1-15/64 | 3-1/2 | 6 Ton |
| J4226CA | 2-Way Crossarm Threaded 3/4"—12 Acme | 11 | 1-5/8 | 5-1/2 | 10 Ton |

2-WAY/3-WAY CROSSARM THREADED 5/8" - 12 ACME

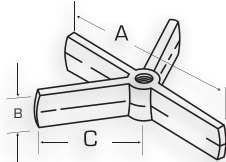

| Product # | Description | Length (in) (A) | Height (in) (B) | Leg Length (in) (C) |
|-----------|--|-----------------|-----------------|---------------------|
| J4208CA | 2-Way/3-Way Crossarm Threaded 5/8"—12 Acme | 7 | 1-15/64 | 3-1/2 |

STANDARD TIP

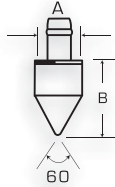

| Product # | Description | Taper | Shaft (in) (A) | Length (in) (B) | Use With Screws |
|-----------|--------------|-------|----------------|-----------------|-------------------|
| J4012T | Standard Tip | 60° | 5/8 | 29/32 | J4225S and J4235S |

JAWS

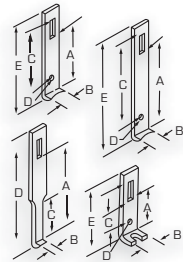

| Product # | Description | Reach (in) (A) | Width (in) (B) | Length (in) (C) | Diameter (in) (D) | Overall Length (in) (E) |
|-----------|-----------------|-------------------|----------------|-----------------|-------------------|-------------------------|
| J4015 | Short Jaw | 4-11/16 | 1-1/2 | 5-1/8 | 25/64 | 7-9/16 |
| J4016A | Dual Reach Jaw | 7-1/8 and 4-11/16 | 1-1/2 | 7-3/8 | 25/64 | 10 |
| J4017 | Long Narrow Jaw | 7-3/16 | 7/8 | 3-3/4 | — | 10 |
| J4018 | Cap Screw Jaw | 2-15/16 | 1-1/2 | 3-9/16 | 25/64 | 5-7/8 |

3-WAY CROSSARM THREADED 3/4" - 12 ACME

| Product # | Description | Radius (in) (A) | Height (in) (B) |
|-----------|--|-----------------|-----------------|
| J4227CA | 3-Way Crossarm Threaded 3/4" - 12 Acme | 5-1/2 | 1-5/8 |

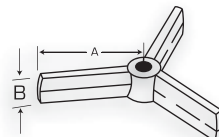

ADJUSTABLE REVERSIBLE JAW

| Product # | Description | Length (in) (A) | Reach (in) (B) |
|----------------|---------------------------|-----------------|----------------|
| J4230RJ | Adjustable Reversible Jaw | 3-5/8 | 2-3/4 |

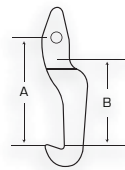

LEGS

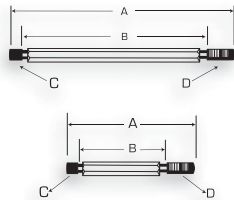

| Product # | Description | Length (in) (A) | Shaft Length (in) (B) | Thread (C) | Thread (D) |
|---------------|-------------|-----------------|-----------------------|-------------|-------------|
| J4240L | Medium Leg | 14-3/16 | 12-19/64 | 1/2"-20 UNF | 5/8"-18 UNF |



SEPARATOR THREADED RODS

| Product # | Length (in) (A) | Thread | For Separator |
|---------------|-----------------|-------------|---------------|
| J4332R | 8-1/2 | 5/8"-18 UNF | J4332 |
| J4333R | 10 | 3/4"-16 UNF | J4333 |



CROSSARM

| Product # | Description | Length (in) (A) | Use with Rod Size |
|---------------|-------------|-----------------|-------------------|
| J4001B | Crossarm | 6-5/8 | 1" - 8 TPI |

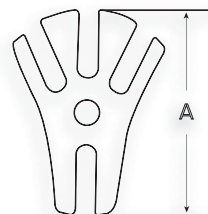

FORCING SCREW

| Product # | Description | Hex Head (in) | Thread | Overall Length (in) | Detachable Tip |
|--------------|---------------|---------------|---------|---------------------|----------------|
| J4012 | Forcing Screw | 3/4 | 3/4"-10 | 11-13/16 | J4012T |



NOTE: ALL PROTO-EASE™ forcing screws are coated at the factory with the latest aerospace dry film lubricant designed to increase screw life, reduce wear and torque required for screw turning. It is recommended that a few drops of medium grade oil (SAE 30 or equivalent) be added to screw threads prior to every use. Screw threads must be kept clean at all times.

YOUR FLEET IS ON THE MOVE. SO ARE YOU.

From trucks to lifters to haulers to movers to almost any vehicle on or off the road, you keep it all working well. Proto® keeps your equipment running well by providing a full line of equipment for Power Trains, Fluid Systems, Electrical System, Chassis, and Support Systems. This includes automotive speciality items like feeler gauges, compression testers, gasket scrapers, and ignition wrenches. Not to mention pullers and extrators of all kinds. We can even keep your shop moving smooth with covers, sliders, and boxes used to keep the work clean and organized. Proto tools are engineered to meet or exceed various government, ASME, and aerospace specifications.

FLEET MAINTENANCE



Diagnostic Smoke Machine

PROTO

EVAP-APPROVED SMOKE MACHINE

- › Patented UltraTraceUV™ the only OEM-approved dye.
- › Auto shut-off.
- › Auto-correct EVAP pressure.
- › Works with nitrogen or shop air to meet all OEM test requirements for all makes and models.
- › Easy, effective, versatile tool to help technicians diagnose EVAP trouble codes on domestic and import cars and light trucks.
- › Uses patented UltraTraceUV™ technology — the only OEM-approved dye available.
- › Works with nitrogen or shop air to meet all OEM test requirements.

| Product # | Voltage | Width (in) | Overall Length (in) | Weight (lbs) |
|---------------|---------|------------|---------------------|--------------|
| JFP521 | 12V | 12-1/2 | 18 | 26.89 |



DIAGNOSTIC SMOKE MACHINE

- › Full featured diagnostic capabilities.
- › Compact and simple to use.
- › EVAP approved.
- › Works with shop air and uses mineral oil.

| Product # | Voltage | Width (in) | Overall Length (in) | Weight (lbs) |
|----------------|---------|------------|---------------------|--------------|
| JFP9510 | 12V | 7 | 12 | 12.86 |



DIFFERENTIAL CYLINDER PRESSURE TESTER

Product #: **JFP210M**

- › Locates internal engine problems such as bad rings, valves, and leaking head gaskets.
- › Includes adapters for most applications (10 mm, 12 mm, and 18 mm).
- › Rugged blow-molded case.
- › Weight (lbs): 4.02



14 PIECE TRANSMISSION/OIL TESTER PRESSURE KIT

- › Professional kit for domestic and foreign applications.
- › High and low pressure gauges for transmission and engine work.
- › Complete with adapters for most applications and is designed for static or road testing.
- › Rugged blow-molded case.
- › Includes:
 - › M8 x 1.0 to 1/8" npt adapter
 - › M10 x 1.0 to 1/8" npt adapter
 - › M12 x 1.75 to 1/8" npt adapter
 - › 1/8" npt x 2" male adapter
 - › 1/4" npt male x 1/8" npt male
 - › 1/8" npt female
 - › 1/4" npt male/female
 - › 3/8" npt male x 1/8" female
 - › 1/8" npt male x 1/8" female
 - › 1/16-27" nptf x 1/8-27" adapter

| Product # | Graduation | Weight (lbs) |
|----------------|--------------------------------------|--------------|
| JFP460M | 1 pound and 5 pound increment gauges | 5.23 |





7 PIECE COMPRESSION TESTER SET

Product #: **JFP70**

- › Complete compression testing on gasoline engines including domestic, foreign, motorcycle, marine, and small engines.
- › Corrosion resistant nickel plated finish adapters for flat and tapered seat plugs.
- › Professional quality gauge with zero adjust.
- › 2-1/2" gauge features chrome bezel and rugged protective outer boot.
- › Extra long 25" flex hose gauge assembly with quick coupler, allows for easy viewing out of cluttered engine compartment.
- › Dual scale gauge reads 0-300 PSI and 0-2100 kg/cm².
- › Rugged blow-molded case with removable lid.
- › Includes:
 - › 12" flex-14 mm standard reach hose
 - › 12" flex-14 mm long reach hose
 - › 10 mm, 12 mm, and 18 mm thread adapters
 - › Repair kit
- › Weight (lbs): 3.84



25 PIECE DELUXE COMPRESSION TEST KIT

Product #: **JFP155**

- › Complete package for compression testing on gasoline engines.
- › Complete kit includes standard and specialty adapters, including the deep well connector used on recessed plug well style heads and the Ford Triton™ engine adapter using 16 mm thread plugs.
- › Includes: 14 mm deep well extension, 12 mm adapter, 18 mm adapter, and 16 mm compression tester adapters.
- › Dual scale gauge reads 0-300 PSI and 0-2100 kg/cm².
- › Rugged blow-molded case.
- › Weight (lbs): 4.67



15 PIECE DIESEL COMPRESSION TESTER

Product #: **JFP97315**

- › 2-1/2" dial, glycerine-filled gauge with glass lens in stainless steel housing.
- › 4,500 PSI rated nylon jacketed pressure hose assembly.
- › Dual scale - 0-1,000 PSI; Metric scale - 0-70 bar.
- › Includes 13 piece adapter set (Deere and BMW adapters included).
- › Easy to read identification marked on case and parts.
- › Rugged blow-molded case.
- › Weight (lbs): 11.38



CAMSHAFT BEARING TOOL

- › Removes or inserts camshaft bearings in most engines from compact cars to heavy trucks.
- › No problems with slightly undersize or oversize bearings.
- › Range of 1-1/8" to 2-19/32" (28.58 mm - 68.3 mm).
- › Rugged blow-molded case.



| Product # | Opening Range (in) | Overall Length Weight | |
|---------------|--------------------|-----------------------|-------|
| | | (in) | (lbs) |
| JFP18A | 1-1/8 to 2-19/32 | 30-19/64 | 16.51 |

VACUUM FUEL PRESSURE SET

- › Ideal for testing vacuum lines and components - quickly diagnose internal engine problems such as bad rings, valves, and leaking head gaskets.
- › Accurately tests low-pressure fuel systems.
- › Helps pinpoint hard-to-find problems such as cracked lines, PCV, fuel pump, fuel filters, and more.
- › Professional dual scale gauge reads vacuum and pressure 0-30" Hg vac and 0-70 cm Hg, also reads 0-15 PSI and 0-100 KPA and offers zero adjust feature.
- › Gauge has a large 3-1/2" face featuring a chrome bezel.
- › Gauge is protected with a rugged outer boot.
- › Built-in rear hook allows gauge to be hung at eye level.
- › Rugged blow-molded case.

| Product # | Graduation | Weight (lbs) |
|----------------|-------------------------|--------------|
| JFP3000 | 1 pound increment gauge | 2.43 |



19 PIECE BASIC FUEL INJECTION TEST KIT

- › For testing the fuel injection systems on most domestic (except GM TBI) and Japanese cars with Schrader type ports.
- › Includes 3-1/2" gauge with a range of 0-145 PSI/0-1000 KPA.
- › All adapters, gauge heads and hose assemblies feature a quick coupling system.
- › Includes adapters to service many domestic, Japanese, and Marine applications.
- › Easy to read identification marked on case and parts.
- › Rugged blow-molded case.

| Product # | Graduation | Weight (lbs) |
|----------------|--------------------------------------|--------------|
| JFP810B | 1 pound and 5 pound increment gauges | 3.46 |



51 PIECE FUEL INJECTION TEST KIT

- › For testing the fuel injection systems on most domestic and foreign cars with Schrader type ports.
- › Includes two gauges:
 - › Large 3-1/2" gauge with a range of 0-145 PSI/0-1000 KPA
 - › Medium 2-1/2" gauge with a range of 0-15 PSI/0-100 KPA
- › All adapters, gauge heads, and hose assemblies feature a quick coupling system.
- › Comes complete with rubber protectors for gauges, instructions, and adapters that will fit most domestic and foreign vehicle systems.
- › Easy to read identification marked on case and parts.
- › Rugged blow-molded case.

| Product # | Graduation | Weight (lbs) |
|------------------|--------------------------------------|--------------|
| JFP1200MS | 1 pound and 5 pound increment gauges | 11.86 |



7 PIECE PNEUMATIC FAN CLUTCH WRENCH SET

Product #: **JFP100**

- › Removes and installs fan clutch when repairing the water pump or fan clutch.
- › Use with air hammer.
- › Includes seven driving wrenches that fit Ford, GM, Chrysler, and Jeep. Sizes include: 7/8", 32 mm, 36 mm, 40 mm thin, 1-7/8", 2", and 47 mm.

| Overall Length (in) | Weight (lbs) |
|---------------------|--------------|
| 18 | 8.03 |





COMPRESSION TESTERS

- › Includes compression gauge, O-ring, and instructional pamphlet.
- › JCTR10 includes:
 - › Flexible hose and quick-disconnect coupler permit fast, easy engagement of threaded fitting into spark plug hole.
 - › Gauge has convenient side release valve and dual reading scale for both PSI and metric values (0 to 300 PSI, 0 to 20 kg/cm²).
 - › Equipped with neoprene "O" rings for positive finger-tight seal.
 - › Includes adapters for regular 18 mm spark plugs and for regular and long 14 mm spark plugs.



| Product # | Overall Length | | Repair Kit |
|-----------|----------------|--------------|------------|
| | (in) | Weight (lbs) | |
| JCTR10 | 10-29/32 | 1.08 | JCTR10RK |
| JCTR20 | 11-29/32 | 1.08 | JCTR20RK |



COMPRESSION GAUGE PARTS

| Product # | Overall Length (in) | Use With | Weight (lbs) |
|-----------|---------------------|---------------|--------------|
| JCTG1 | 3-1/2 | JCT21, JCTR10 | 0.39 |
| JCT21RK | 7-3/16 | JCT21 | 0.29 |
| JCTR10-7A | 7/16 | JCTR10 | 0.01 |
| JCTR10RK | 22-5/16 | JCTR10 | 0.80 |
| JCTR20-4C | 2-5/16 | JCTR20 | 0.35 |
| JCTR20RK | 9-1/2 | JCTR20 | 0.48 |



MASTER SERPENTINE BELT TOOL

- › Spring-loaded idler pulley releases tension on serpentine belts.
- › Use to remove and install belts on serpentine belt systems.
- › Fits idler pulleys requiring 13 mm, 14 mm, 15 mm, 16 mm, 18 mm, 19 mm, hex, and both 3/8" and 1/2" square drive sizes.
- › For applications with limited access; 13 mm and 16 mm, and 19 mm sockets are built into the handle.
- › Covers most domestic and some foreign applications.
- › Comes with extension for hard-to-reach idler pulleys.
- › Eight low profile sockets and extensions help to fit into tight places.



| Product # | Width (in) | Height (in) | Overall Length (in) | Weight (lbs) |
|-----------|------------|-------------|---------------------|--------------|
| JFP59800 | 2-1/2 | 2-13/64 | 24-13/32 | 2.36 |



ADJUSTABLE PIN SPANNER WRENCH

- › Universal design fits many different types of pulleys having slots or holes, including camshaft and crankshaft pulleys.
- › Wrench is adjustable from 1-1/4" to 5".
- › Works with a 1/2" ratchet or breaker bar.



| Product # | Opening Range (in) | Overall Length (in) | Weight (lbs) |
|-----------|--------------------|---------------------|--------------|
| JFP661 | 1-1/4 to 5 | 20-29/32 | 2.63 |

5 PIECE CAM CLAMP SET

- › Master kit contains a dual Cam-Clamp and four Cam-Clamp singles.
- › Use on single, dual, or quad overhead cam engines to hold valve timing during belt replacement.
- › Kit provides coverage for all timing belt applications.
- › Single Cam-Clamps lock gears individually.
- › Miniature design is easy to use; installs in seconds.

| Product # | Width (in) | Height (in) | Overall Length (in) | Weight (lbs) |
|-----------|------------|-------------|---------------------|--------------|
| JFP70900 | 13-1/2 | 2-3/4 | 17-1/4 | 0.78 |



LARGE VALVE SPRING COMPRESSOR

- › Designed to compress valve springs on overhead valve engines.
- › Direct action compressor lever provides high visibility of valve spring retainers located in difficult access areas.
- › Includes two valve spring adapters, which fit valve spring retainers up to 1" (25 mm) and 1-3/16" (30 mm).
- › Jaw opening of 1-3/8" to 5-5/8" (35 mm to 142 mm).
- › Throat clearance of 5-7/8" (150 mm).

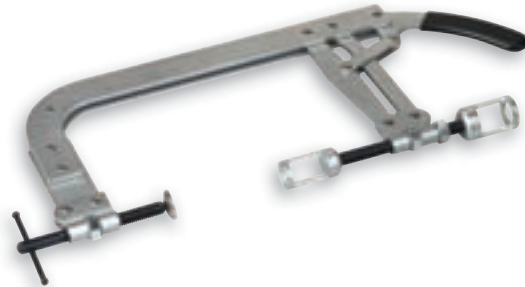

| Product # | Jaw Opening (in) | Width (in) | Height (in) | Overall Length (in) | Weight (lbs) |
|-----------|------------------|------------|-------------|---------------------|--------------|
| JFP572 | 5-5/8 | 8-19/64 | 1-7/16 | 16-51/64 | 5.27 |

17 PIECE FLARING TOOL COMBINATION KIT

Product #: JFP501

- › Includes all adapters and tools necessary for single and double flaring (standard and metric) as well as the ISO (bubble) flare.
- › Works on aluminum, copper, and soft steel.
- › Not recommended for use on stainless steel.



| Overall Length (in) | Weight (lbs) |
|---------------------|--------------|
| 9-1/2 | 3.82 |

BUDD WHEEL DEEP LENGTH IMPACT SOCKETS

- › Stamped size for easy reference.
- › Side locking hole.



| Product # | Size (in) | Drive Size (in) | Drive End Outside Diameter (in) | Nut End Outside Diameter (in) | Overall Length (in) | Weight (lbs) |
|-----------|-----------|-----------------|---------------------------------|-------------------------------|---------------------|--------------|
| J07524-LS | 1-1/2 | 3/4 | 1-5/8 | 2-1/4 | 4 | 3.12 |
| J09924-LS | 1-1/2 | #5 Spline | 2-3/8 | 2-3/8 | 4-3/16 | 3.10 |
| J10024LS | 1-1/2 | 1 | 2-3/8 | 2-3/8 | 4 | 2.96 |





3/8" DRIVE SPARK PLUG SOCKETS - 6 POINT

- › With rubber insert.



| Product # | Size (in) | Drive Size (in) | Nut End Outside Diameter (in) | Overall Length (in) | Weight (lbs) |
|-----------------|-----------|-----------------|-------------------------------|---------------------|--------------|
| J5020-50 | 5/8 | 3/8 | 3/16 | 2-1/2 | 0.21 |
| J5026HPA | 13/16 | 3/8 | 19/64 | 2-3/4 | 0.35 |

3/8" DRIVE UNIVERSAL SPARK PLUG SOCKETS - 6 POINT

- › With rubber insert.



| Product # | Size (in) | Drive Size (in) | Drive End Outside Diameter (in) | Nut End Outside Diameter (in) | Nut Depth (in) | Overall Length (in) | Weight (lbs) |
|------------------|-----------|-----------------|---------------------------------|-------------------------------|----------------|---------------------|--------------|
| J5020-70A | 5/8 | 3/8 | 23/32 | 27/32 | 5/16 | 3-19/64 | 0.26 |
| J5026-50A | 13/16 | 3/8 | 23/32 | 1-1/16 | 5/16 | 3-3/8 | 0.34 |

3/8" DRIVE EXTRA DEEP SPARK PLUG SOCKET

- › Rubber retainer holds spark plug in place.
- › Knurled for hand turning.



| Product # | Size (in) | Size (mm) | Drive Size (in) | Point Size | Overall Length (in) | Weight (lbs) |
|-------------------|-----------|-----------|-----------------|------------|---------------------|--------------|
| JFED2032RD | 5/8 | 15.9 | 3/8 | 6 | 4 | 0.71 |

9 PIECE SPARK PLUG SET

- › Includes three different sizes and three different configurations most commonly used when working with spark plugs.
- › 9/16", 5/8", and 13/16" spark plug sockets in standard, universal, and extra deep lengths.
- › Chromed finish for easy clean-up and long-lasting corrosion protection.
- › 3/8" square drive sockets feature a rubber insert to securely grab the spark plug.
- › Each socket is knurled for easy hand turning.
- › Rugged blow-molded case.



| Product # | Drive Size (in) | Point Size | Overall Length (in) | Weight (lbs) |
|----------------|-----------------|------------|---------------------|--------------|
| JFP9SET | 3/8 | 6 | 12 | 5.50 |

9 PIECE SPARK PLUG SET - BLACK

- › Includes three different sizes and three different configurations most commonly used when working with spark plugs.
- › 9/16", 5/8", and 13/16" spark plug sockets in standard, universal, and extra deep lengths.
- › Universal styles for most applications.
- › 3/8" square drive sockets feature a rubber insert to securely grab the spark plug.
- › Each socket features a knurl for easy hand turning.
- › Black-oxide finish.
- › Rugged blow-molded case.



| Product # | Drive Size (in) | Point Size | Overall Length (in) | Weight (lbs) |
|-----------------|-----------------|------------|---------------------|--------------|
| JFP9BSET | 3/8 | 6 | 14 | 5.26 |

SPARK PLUG BOOT PULLERS

- › Allows for easy access to the spark plug boot.



| Product # | Bend Angle | Height (in) | Overall Length (in) | Weight (lbs) |
|----------------|------------|-------------|---------------------|--------------|
| JFE600A | 30° | 1-19/32 | 15-13/32 | 0.89 |
| JFE700A | 40° | 1-19/32 | 15-13/32 | 0.88 |

TAILPIPE AND EXHAUST CUT-OFF TOOL

- › 15 mm diameter cutters.
- › Cuts thick and thin walled pipe from 3/4" to 3-1/4" (19 mm to 83 mm) in diameter.
- › 1/4 turn for complete cut.
- › Cutting wheels on every pivot.



| Product # | Capacity (in) | Overall Length (in) | Weight (lbs) |
|---------------|---------------|---------------------|--------------|
| JFP770 | 3-1/4 | 14-1/2 | 1.14 |

STETHOSCOPE

- › Fast, accurate method for locating trouble in engines.
- › Determines if moving parts are worn, such as pistons, gears, valves, water pumps, gaskets, bearings, etc.
- › Plastic ear protectors help reduce shop noise.
- › Spring steel diaphragm for long use.
- › Shock resistant handle.



| Product # | Height (in) | Overall Length (in) | Weight (lbs) |
|----------------|-------------|---------------------|--------------|
| JFP500A | 2-3/32 | 14-29/32 | 0.47 |



13 PIECE IGNITION SET

Product #: **J3200C**



| Contents | Size (in) | Overall Length (in) |
|----------|---------------------------|---------------------|
| J3210 | 13/64 x 15/64 | 3 |
| J3211 | 15/64 x 13/64 | 3 |
| J3215 | 7/32 x 1/4 | 3 |
| J3216 | 1/4 x 7/32 | 3 |
| J3220 | 9/32 x 5/16 | 3-1/2 |
| J3221 | 5/16 x 9/32 | 3-1/2 |
| J3225 | 11/32 x 3/8 | 3-3/4 |
| J3226 | 3/8 x 11/32 | 3-3/4 |
| J000D | Ignition Feeler Gauge Set | |
| J235 | Ignition Pliers | |
| J2302 | Ignition Point File | |
| J9853 | Screw Start | |
| 66-101 | Pocket Screwdriver | |
| J25TR10C | Tool Roll | |

- › Satin finish provides corrosion resistance and a slip-resistant grip.
- › 15° and 60° angle heads combined with the same opening size on both ends allows the wrench to be used in four different turning angles.
- › Standard open end wrench configuration.
- › Weight (lbs): 0.67



9 PIECE IGNITION SET

Product #: **J3200D**



| Contents | Size (in) | Overall Length (in) |
|----------|-----------------|---------------------|
| J3210 | 13/64 x 15/64 | 3 |
| J3211 | 15/64 x 13/64 | 3 |
| J3215 | 7/32 x 1/4 | 3 |
| J3216 | 1/4 x 7/32 | 3 |
| J3220 | 9/32 x 5/16 | 3-1/2 |
| J3221 | 5/16 x 9/32 | 3-1/2 |
| J3225 | 11/32 x 3/8 | 3-3/4 |
| J3226 | 3/8 x 11/32 | 3-3/4 |
| J235 | Ignition Pliers | |
| J25TR09C | Tool Roll | |

- › Satin finish provides corrosion resistance and a slip-resistant grip.
- › 15° and 60° angle heads combined with the same opening size on both ends allow the wrench to be used in four different turning angles.
- › Standard open end wrench configuration.
- › Weight (lbs): 0.47



IGNITION POINT FILE

- › Tungsten file for spark plugs, distributors, and other electrical contact points.
- › Has chisel tip and smooth extended grip.

| Product # | Overall Length (in) | Weight (lbs) |
|--------------|---------------------|--------------|
| J2302 | 5-1/4 | 0.01 |



MIDGET ANGLE NOSE PLIERS

- › Nose angled for easy access.
- › Angled teeth provide superior gripping power over standard right angled teeth.
- › Plastisol grips for added comfort.

| Product # | Jaw Length (in) | Jaw Width (in) | Jaw Thickness (in) | Overall Length (in) | Weight (lbs) |
|-------------|-----------------|----------------|--------------------|---------------------|--------------|
| J235 | 3/4 | 5/8 | 11/64 | 4-1/16 | 0.10 |



GASKET AND CARBON SCRAPERS

- › Angled blade for access into tight areas.
- › Ideal for removing gaskets and carbon.
- › Comfortable, four-sided handle.

| Product # | Blade Width (in) | Overall Length (in) | Weight (lbs) |
|-----------|------------------|---------------------|--------------|
| J2336 | 1-1/2 | 12 | 0.30 |
| J2338 | 1-1/16 | 11 | 0.38 |



COTTER PIN PULLER

- › Precision formed curves provide excellent leverage in prying out cotter pins quickly and easily.
- › Large plastic handle.

| Product # | Blade Length (in) | Overall Length (in) | Weight (lbs) |
|-----------|-------------------|---------------------|--------------|
| J2306 | 3-7/16 | 7-3/4 | 0.25 |

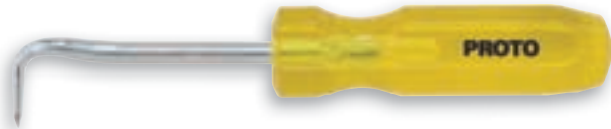

PISTON RING COMPRESSOR

- › Wide band has ratchet mechanism to prevent breakage and slippage.
- › Includes "L" handle.

| Product # | Diameter Minimum (in) | Diameter Maximum (in) | Height (in) | Weight (lbs) |
|-----------|-----------------------|-----------------------|-------------|--------------|
| J2316 | 2-1/8 | 5 | 3-1/2 | 0.70 |



5 PIECE OIL FILTER CUP WRENCH SET

Product #: JFFKIT5

- › Filter cup wrenches will service 98% of the cars in the U. S. A.
- › Made of super-strong nylon fiber composite that will withstand more torque than conventional metal filter wrenches.
- › Metal insert in wrench.
- › Includes:
 - › 65/67 mm, 14 flute oil filter
 - › 74/76 mm, 15 flute oil filter
 - › 76 mm, 14 flute oil filter cup
 - › 93 mm, 15 flute oil filter cup
 - › 76/80/93 mm, 30/15/36 flute oil



| Diameter Minimum (in) | Diameter Maximum (in) | Diameter Minimum (mm) | Diameter Maximum (mm) | Width (in) | Height (in) | Overall Length (in) | Weight (lbs) |
|-----------------------|-----------------------|-----------------------|-----------------------|------------|-------------|---------------------|--------------|
| 2-1/2 | 3-5/8 | 65 | 93 | 8-3/32 | 3 | 12 | 2.30 |

SELF-GRIPPING OIL FILTER WRENCH

- › Use for removal and installation of oil filters.
- › Filter sizes: 3-1/8" - 4-3/4" (80 mm-120 mm).
- › 3/8" drive (also includes 1/2" drive adapter).



| Product # | Diameter Minimum (in) | Diameter Maximum (in) | Diameter Minimum (mm) | Diameter Maximum (mm) | Width (in) | Height (in) | Overall Length (in) | Weight (lbs) |
|-----------|-----------------------|-----------------------|-----------------------|-----------------------|------------|-------------|---------------------|--------------|
| JFF120 | 3-1/8 | 4-3/4 | 80 | 120 | 3-29/32 | 3-19/64 | 4-13/64 | 1.51 |





HEAVY-DUTY FILTER STRAP WRENCH

- › Heavy-duty cordura strap for high-torque application requirements.
- › For 3/8" and 1/2" ratchet or breaker bar use.
- › Fits large oil filters up to 9" (228 mm) diameter.



| Product # | Diameter Minimum (in) | Diameter Maximum (in) | Diameter Minimum (mm) | Diameter Maximum (mm) | Width (in) | Height (in) | Overall Length (in) | Weight (lbs) |
|---------------|-----------------------|-----------------------|-----------------------|-----------------------|------------|-------------|---------------------|--------------|
| JFF278 | 4 | 9 | 100 | 228 | 3-51/64 | 1-1/2 | 6-19/32 | 0.58 |

OIL FILTER WRENCHES

- › Handle swivels to avoid obstructions.
- › Stainless steel band for added strength.

| Product # | Diameter Minimum (in) | Diameter Maximum (in) | Overall Length (in) | Weight (lbs) |
|--------------|-----------------------|-----------------------|---------------------|--------------|
| J3007 | 2-7/8 | 3-1/4 | 8 | 0.81 |
| J3006 | 3-1/2 | 3-7/8 | 8-1/2 | 0.81 |
| J3008 | 4-1/8 | 4-1/2 | 9-1/2 | 0.88 |



SWIVEL OIL FILTER WRENCH

- › Stainless steel band with projection welds for strength and anti-corrosion.
- › Heat-treated swivel handle adjusts to a wide arc of positions.
- › Minimum grip: 4-1/8" (104.7 mm).
- › Maximum grip: 4-7/16" (112.7 mm).
- › Over 150 foot pounds of torque.



| Product # | Diameter Minimum (in) | Diameter Maximum (in) | Diameter Minimum (mm) | Diameter Maximum (mm) | Height (in) | Overall Length (in) | Weight (lbs) |
|-----------------|-----------------------|-----------------------|-----------------------|-----------------------|-------------|---------------------|--------------|
| JFF5325A | 4-1/8 | 4-7/16 | 104.7 | 112.7 | 1 | 10 | 0.65 |

ADJUSTABLE OIL FILTER PLIERS

- › Heavy-duty forged jaws with three contact points to grip stubborn oil filters.
- › Textured grips for non-slip operation.



| Product # | Opening Range (in) | Diameter Minimum (in) | Diameter Maximum (in) | Diameter Minimum (mm) | Diameter Maximum (mm) | Height (in) | Overall Length (in) | Weight (lbs) |
|----------------|--------------------|-----------------------|-----------------------|-----------------------|-----------------------|-------------|---------------------|--------------|
| JFF245B | 2 to 4-1/4 | 2 | 4-1/4 | 51 | 107 | 29/32 | 11-29/32 | 1.00 |
| JFF297 | 2-1/4 to 5 | 2-1/4 | 5 | 57 | 127 | 19/32 | 13-19/32 | 1.25 |
| JFF287 | 3-3/4 to 7 | 3-3/4 | 7 | 94 | 178 | 1 | 19 | 3.28 |

SPILL-FREE FUNNEL

Product #: **JFF160**

- › Threaded cap and adapter for newer GM "threaded style" radiator openings.
- › Eliminates trapped air pockets which can cause erratic cooling system and heater performance.
- › Controls amount of coolant entering system and enables unattended filling of the cooling system.
- › Eliminates squeaky belts caused by coolant overflow and protects the environment.
- › Includes four adapters which fit most domestic and foreign vehicles and light trucks.
- › Angled neck for use with radiator caps placed at an angle.
- › Weight (lbs): 1.15



8 GALLON OIL LIFT DRAIN

- › Quick-release lock ring for fast raising and lowering of upper tube.
- › Total adjustment range of 22-1/2".
- › Large 15" funnel with strainer.
- › Heavy-duty clamp with height adjustment range of 15".
- › Specially shaped container holds up to 8 gallons.
- › Reinforced base will help prevent warping from hot oil.
- › Large handles and big pour spout for easy pouring.
- › 2-1/2" ball bearing wheels (4) swivel and roll easily.



| Product # | Height (in) | Weight (lbs) |
|-----------------|-------------|--------------|
| JFF11102 | 48-1/2 | 13.38 |

OIL PAN PLUG RETHREAD TOOL

Product #: **JFF885**

- › Removes damaged thread and taps a new oversize thread.
- › Unique tapping tool ensures the new thread will be perpendicular to the gasket surface and prevent leakage.
- › Works on soft steel and aluminum oil pans with 1/2", 12 mm, and 14 mm threads.
- › Includes:
 - › 5 Magnetic plug and gaskets
 - › Piloted drill assembly
 - › Tap
 - › Spacer
- › Weight (lbs): 1.72



4 PIECE LOCKING HOSE CLAMP PLIERS SET

- › Complete unique locking coolant system pliers set is ideal for one-person replacement of radiators, cooling lines, etc.
- › Locking waffle-nose hose clamp pliers to access/open hard-to-reach flat band hose clamps (7" and 9").
- › Locking hose pinch-off pliers to pinch and lock closed vent/radiator/vacuum/fuel hoses/lines (7" and 9").
- › Packaged in sturdy nylon roll pouch.



| Product # | Height (in) | Overall Length (in) | Weight (lbs) |
|---------------|-------------|---------------------|--------------|
| JFFHC4 | 6-1/4 | 12-19/64 | 3.50 |





RIGID-FLEXIBLE HOSE CLAMP PLIERS

Product #: **JFFCP700**

- › Shaft holds position to connect to clamps.
- › Extension for hard-to-reach radiator clamps.
- › Flexible shaft helps reach difficult locations.
- › Locking arm keeps clamps locked in open position.
- › Weight (lbs): 1.35



PINCH-OFF PLIERS

- › Patented clamping mechanism provides positive clamping without springs or adjustments.
- › Tested to 50,000 cycles without failure.
- › Heat-treated steel construction.
- › Swivel mounted clamps adjust to provide parallel clamping operation.
- › Cushioned hand grips.
- › For pinching-off flexible fuel lines, brake lines, and vacuum hoses in cars, motorcycles, and engines of all kinds.



| Product # | Jaw Opening (in) | Jaw Width (in) | Jaw Depth (in) | Throat Depth (in) | Throat Height (in) | Max. Jaw Capacity (in) | Overall Length (in) | Weight (lbs) |
|---------------|------------------|----------------|----------------|-------------------|--------------------|------------------------|---------------------|--------------|
| JFF554 | 3/4 | 2 | 1/2 | 1-1/2 | 1/2 | 3/4 | 5-1/2 | 0.19 |
| JFF555 | 2 | 2 | 1/2 | 1-1/2 | 1/2 | 1-1/4 | 9-1/4 | 0.78 |
| JFF556 | 2-1/2 | 2 | 1/2 | 2-1/2 | 1/2 | 2-1/2 | 13-3/4 | 1.25 |

UNIVERSAL RADIATOR ADAPTER

Product #: **JFF4500**

- › Compatible with all brands of radiator pressure testers and reservoir tank systems.
- › Offers 95% application coverage for most cars and light trucks.
- › Durable hard body adapter does not require inflation or conditioning.
- › Weight (lbs): 0.66



ETHYLENE GLYCOL ANTIFREEZE TESTER

Product #: **JFF106A**

- › Professional size 16" disc-type antifreeze tester.
- › Easy to read magnified plastic barrel.
- › Tests all ethylene glycol based antifreeze including Dex-Cool®, hot or cold.
- › The degree of coolant protection is indicated by the number of floating discs.
- › Temperature compensating with Fahrenheit and Celsius scales from +32°F to -60° F.
- › Weight (lbs): 0.46



ANTIFREEZE TESTER

Product #: **JFFCC3**

- › Compact, lightweight, and break-resistant.
- › Easy to read plastic housing.
- › Tests all ethylene glycol based antifreeze including Dex-Cool®, hot or cold.
- › Temperature compensating with Fahrenheit and Celsius scales from +32°F to -60° F.
- › Weight (lbs): 0.20



6 PIECE LARGE TRUCK COOLING SYSTEM ADAPTER SET

Product #: **JFF600**

- › Compatible with most cooling system pressure generating pumps.
- › Includes six cooling system adapters:
 - › Large trucks with "B" half turn twist on filler neck
 - › International, Freightliner, and others (52 mm x 2.5 mm)
 - › Volvo trucks (63 mm x 3 mm)
 - › Additional Volvo trucks (48 mm x 3 mm)
 - › Freightliner trucks (60 mm x 3 mm)
 - › Late model Kenworth and Peterbilt (52 mm x 2.5 mm)
- › Weight (lbs): 5.24



23 PIECE COMPLETE AUTO COOLING SYSTEM TESTER

Product #: **JFF1700**

- › For cars and light trucks.
- › Pump attaches to filler neck.
- › 17 adapters included (one is dual adapter).
- › Adapter resembles cap from system being tested.
- › Includes:
 - › Complete pressure pump assembly with knob
 - › Pressure gauge
 - › Adapters
- › Weigh (lbs): 15.36

| Adapter Sizes |
|----------------|
| 48 mm x 3 mm |
| 45 mm x 3 mm |
| 56.6 mm x 3 mm |
| 52 mm x 3 mm |
| 52 mm x 2.5 mm |
| 63 mm x 3 mm |
| 62 mm x 4 mm |
| 52 mm x 3 mm |
| 34 mm x 3 mm |





4 PIECE COOLING SYSTEM PRESSURE TESTER

Product #: **JFF730MA**

- › Tests all systems from 4 PSI to 30 PSI caps and 3 to 30 lbs. pressure range.
- › Easy to read 2.5" gauge.
- › Large barrel with a quick pump.
- › Includes: 15" hose, head assembly, cap adapter, and instruction manual.
- › Weight (lbs): 4.83



4 PIECE QUICK DISCONNECT TOOL KIT

- › Contains one each of all four sizes of Jiffy-Tite quick disconnect tools (3/8", 1/2", 5/8" and 5/8" 30%).
- › Applications include light-duty GM cars, trucks, vans, SUVs, and medium-duty GM trucks.
- › Rugged blow-molded case.



| Product # | Height (in) | Overall Length (in) | Weight (lbs) |
|------------------|-------------|---------------------|--------------|
| JFFJT4KIT | 1-11/16 | 6-1/2 | 0.72 |

6 PIECE ANGLED DISCONNECT SET

Product #: **JFFDS400**

- › Disconnects air conditioning, quick connect fuel lines, and spring lock couplings on Ford and Chrysler A/C lines.
- › Works on fuel lines and other quick disconnect couplings on domestic and foreign vehicles.
- › Angled handles to access tight spots.
- › Made of durable plastic that resists fuels and solvents.
- › Includes sizes: 5/16", 3/8", 1/2", 5/8", 3/4", and 7/8".

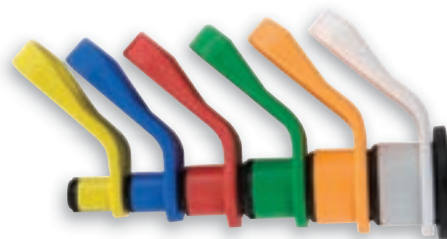

| Height (in) | Overall Length (in) | Weight (lbs) |
|-------------|---------------------|--------------|
| 1-1/2 | 3 | 0.16 |

19 PIECE MASTER DISCONNECT SET

Product #: **JFF5000**

- › A complete set of the most popular disconnect tools for AC, fuel, transmission, oil cooler, and air lines.
- › A step above the JFF4000 Proto® Master Disconnect Set.
- › Rugged blow-molded case.
- › Includes:
 - › 3/8" Jiffy-Tite® Disconnect
 - › 1/2" Jiffy-Tite® Disconnect
 - › Air line disconnect set
 - › Low-Profile Fuel Line Disconnect Set
 - › AC/Fuel Line Disconnect Set
 - › Fuel Line Quick Disconnect for GM
 - › Angled AC/Fuel Line Disconnect Set
 - › 5/16" x 3/8" Scissor Disconnect
 - › Coupler Disconnect
 - › Ford Transmission Line Disconnect



| Width (in) | Height (in) | Overall Length (in) | Weight (lbs) |
|------------|-------------|---------------------|--------------|
| 12-13/32 | 3 | 15 | 3.62 |

21 PIECE MASTER DISCONNECT SET

Product #: **JFF4000**

- › Low profile 3/8" flex fuel disconnect tool for disconnecting hard-to-reach and difficult fuel filters.
- › Stepped disconnect tools fit transmission oil cooler lines on many Fords and other vehicles.
- › Low-profile fuel module disconnect for GM works great on Suburban, Tahoe, and full-sized truck module applications.
- › Coupler disconnect fits applications on transmissions, power steering, and radiators.
- › Includes:
 - › 6 Piece Angled Disconnect Set
 - › 6 Piece Angled AC/Fuel Line Disconnect Set
 - › Fuel Filter Disconnect for GM
 - › Hairpin Disconnect
 - › Fuel Line Quick Disconnect for GM
 - › 5/16" and 3/8" Scissor Disconnect
 - › Coupler Disconnect
 - › Ford Transmission Line Disconnect Set



| Width (in) | Height (in) | Overall Length (in) | Weight (lbs) |
|------------|-------------|---------------------|--------------|
| 8-1/2 | 2-3/32 | 11-51/64 | 1.68 |

RATCHET-STYLE TUBING CUTTER

- › High-impact fiberglass handle is lightweight and durable.
- › Cuts copper, plastic, and PVC pipe from 1/8" to 3/8" (3.2 mm to 9.5 mm).
- › Easily adjusts to fit pipe.



| Product # | Capacity (in) | Overall Length (in) | Weight (lbs) |
|---------------|---------------|---------------------|--------------|
| JFF375 | 3/8 | 6 | 0.27 |

THERMOSTAT GASKET CLEANER

- › Cleans hard-to-reach gasket surfaces.
- › Use with a die grinder to quickly clean gasket surfaces, oil pans, water pumps, and other inaccessible applications.
- › Equipped with a floating guide shaft so user can steer the abrasive pad around the gasket surface.
- › Use on oil pans, water pumps, and other gasket areas.

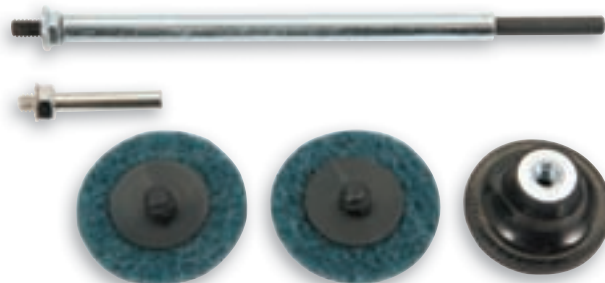

| Product # | Height (in) | Overall Length (in) | Weight (lbs) |
|----------------|-------------|---------------------|--------------|
| JFF2250 | 1-1/2 | 8 | 0.31 |





RATCHET PUMP

- › Converts any 3/8" air ratchet to a fluid transfer pump.
- › Fill or drain brake fluid, power steering fluid, transmission fluid, engine oil, coolant, gear oils, and more (Not approved or intended for use with gasoline or flammable fluids).
- › Quick coupling fittings allow easy hose changes and no-drip storage of pump.
- › Fast draw rates:
 - › Transmission fluid 1L (34 oz.) in 40 seconds (8 mm)
 - › 20/50 motor oil 1L (34 oz.) in 45 seconds (6 mm)
- › Includes the ratchet pump, 39" 8 mm discharge hose, 31" 6 mm suction straw, 19" 8 mm suction hose packaged in a rugged blow-molded case (Air ratchet not included).



| Product # | GPM/IPM | Overall Length (in) | Weight (lbs) |
|---------------|----------------------|---------------------|--------------|
| JFF910 | 36 ounces per minute | 8 | 2.23 |

HOSE CLAMP PLIERS

- › Installs and removes wire spring tension clamps.
- › Two position jaws grip full range of clamp sizes.
- › Plastisol grips for added comfort.

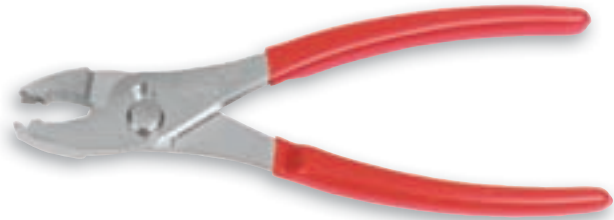

| Product # | Overall Length (in) | Weight (lbs) |
|--------------|---------------------|--------------|
| J252G | 7-3/4 | 0.56 |

900 PEAK AMP ULTRA-PORTABLE JUMP STARTER

- › Built-in battery charger (accepts standard 110v extension cords) with automatic overcharge protection.
- › Built-in removable flashlight.
- › 27" #4 AWG cables with full-size clamps.
- › 9 amp-hour battery.
- › Lightweight.
- › 12v DC power socket to power accessories.



| Product # | Voltage | Weight (lbs) |
|----------------|---------|--------------|
| JFE5120 | 12V | 10.00 |

6V/12V/24V FLEET CHARGER

- › UL/CUL/CSA approved for indoor/outdoor use.
- › 455 amp manufacturers boost rating.
- › 255 amp UL continuous assist rating.
- › 75-/65-/30 amp UL continuous rating.
- › Automatic 90-minute timer with hold position.
- › AC and DC circuit overload protected.
- › Patented "Stop/Go Light".
- › Heavy-duty chrome handle.
- › Fan cooled.
- › 500 amp rated clamps.



| Product # | Voltage | Weight (lbs) |
|-----------------|----------|--------------|
| JFEH6006 | 6/12/24V | 45.00 |

12V/24V FLEET CHARGER

- › Commercial quality jump starter designed for heavy-duty and over the road jump starting applications.
- › Built-in automatic 10 Amp battery charger.
- › 12/24 volt settings.
- › 1400 Cold cranking amps in 12 volt mode.
- › 800 Cold cranking amps in 24 volt mode.
- › 10' Jumper cable leads (1/0 welding cable).

| Product # | Voltage | Weight (lbs) |
|-----------|---------|--------------|
| JFE14289 | 12/24V | 52.00 |



6 PIECE BATTERY KIT

- › Complete battery tool service kit with pouch.
- › Includes:
 - › Extra long 5/16" ratcheting terminal wrench
 - › 5/16" standard length ratcheting terminal wrench
 - › 10 mm standard length ratcheting terminal wrench
 - › Battery pliers
 - › 4-in-1 battery terminal cleaner
 - › Battery puller/lifter

| Product # | Height (in) | Overall Length (in) | Weight (lbs) |
|-----------|-------------|---------------------|--------------|
| JFE6KIT | 11-19/32 | 11-19/32 | 2.47 |



12 PIECE TERMINAL TOOL KIT

Product #: JFE96030

- › Fits most GM computer connectors and terminals.
- › Individually handled for easy access into tight places.
- › Color coded for easy identification.
- › Weight (lbs): 0.73

| Red Anodized Handle | Green Anodized Handle |
|---------------------------------------|-------------------------|
| Tube, Spring-Loaded, 3.3 mm x 28.0 mm | Tube, 3.3 mm x 28.0 mm |
| Square Blade, 1.4 mm x 19.0 mm | Tube, 4.3 mm x 13.0 mm |
| Flat Blade, 1.5 mm x 24.75 mm | Tube, 3.75 mm x 13.0 mm |
| Flat Blade, 2.0 mm x 23.0 mm | Tube, 3.0 mm x 13.0 mm |
| Fork Blade, 8.0 mm x 24.0 mm | Flat Twin Blade, 3.0 mm |
| Flat Blade Screwdriver, 3/16" x 1" | Flat Twin Blade, 1.6 mm |



AUTO MEMORY SAVER

- › Prevents the loss of electronic memory when disconnecting the vehicle's battery.
- › High visibility coiled cord stretches to 8 feet.
- › Easy storage in tool box.
- › OBD2 connection uses positive and ground pins only, will not interfere with fault codes.
- › Coiled cord prevents tangles.
- › In-line fuse.
- › Cigarette lighter input - 12 volt power source not included.



| Product # | Voltage | Width (in) | Height (in) | Cable Length (in) | Weight (lbs) |
|-----------|---------|------------|-------------|-------------------|--------------|
| JFE28 | 12V | 4 | 1-5/16 | 96 | 0.46 |



11 PIECE OXYGEN SENSOR SOCKET SET

- › Master oxygen sensor and sending unit tool set.
- › Includes:
 - › 1/2" x 29 mm x 90 mm oxygen sensor socket
 - › 3/8" x 7/8" x 90 mm oxygen sensor socket
 - › 1/2" x 27 mm x 85 mm fuel injector socket
 - › 3/8" x 7/8" x 80 mm vacuum switch socket
 - › 3/8" x 1-1/16" x 74 mm oil sending unit socket
 - › 3/8" x 7/8" x 50 mm oxygen sensor socket
 - › 3/8" x 7/8" x 30 mm offset oxygen sensor wrench
 - › 3/8" x 22 mm special tube socket
 - › 2-1/8" offset oxygen sensor wrench
 - › 3/8" deep oxygen sensor socket
 - › Oxygen sensor thread chaser

| Product # | Height (in) | Overall Length | | Weight (lbs) |
|----------------|-------------|----------------|------|--------------|
| | | (in) | (in) | |
| JFE0S11 | 9 | 15 | 8.10 | |



BATTERY POST AND TERMINAL CLEANER

- › Circular outer brush cleans contact area.
- › Cleans cable end with cap removed.

| Product # | Overall Length (in) | Weight (lbs) |
|--------------|---------------------|--------------|
| J2320 | 3-15/16 | 0.14 |



BATTERY TERMINAL SPREADER AND REAMER

- › Spreads and cleans clamps in one quick operation.
- › Plastisol grips for added comfort.

| Product # | Overall Length (in) | Weight (lbs) |
|-------------|---------------------|--------------|
| J319 | 7-1/2 | 0.55 |



LARGE BED CREEPER

- › Heavy-duty design supports a maximum load of 600 lbs. and a dynamic load capacity of 400 lbs.
- › Extra-wide 19" x 43" contoured bed with pillowstyle raised headrest provides ample shoulder, hip, and head support.
- › 1" diameter, welded and powder-coated steel tubular frame.
- › 1-1/2" ground clearance.
- › Six 3" industrial grade casters for easy movement on rough shop floors.

| Product # | Capacity (lbs) | Width (in) | Overall Length (in) | Weight (lbs) |
|----------------|----------------|------------|---------------------|--------------|
| JFC600B | 600 | 19 | 43 | 23.79 |



SPIDER CREEPER

- › 40" heavy-duty creeper.
- › Full-size, comfortable, and tough.
- › 400 lbs. capacity; sturdy and reliable for the most brutal shop environments.
- › 1/2" ground clearance / 2" minimum height allows user to perform services beneath very low profile vehicles.
- › Six 3" industrial grade casters for easy movement on rough shop floors.
- › 1-1/2" powder coated steel constructed frame.



| Product # | Capacity (lbs) | Width (in) | Overall Length (in) | Weight (lbs) |
|-----------|----------------|------------|---------------------|--------------|
| JFC400SPI | 400 | 18 | 40 | 26.91 |

HEAVY-DUTY TOOL TROLLEY

- › 500 lbs. seating capacity.
- › 18" seating height.
- › 1" chrome finished tubular steel constructed frame.
- › 3" industrial grade hard floor casters, 2 with brakes.
- › Comfortable 16" x 16" x 3-1/2" thick vinyl fabric over foam seat.
- › Contoured 12" x 6" x 2-1/2" thick vinyl over foam back.
- › 12" x 18" x 1-3/4" heavy-duty stamped steel tool tray.



| Product # | Capacity (lbs) | Width (in) | Height (in) | Weight (lbs) |
|-----------|----------------|------------|-------------|--------------|
| JFC1010 | 500 | 16 | 36 | 21.38 |

HEAVY-DUTY SHOP STOOL

- › 300 lbs. seating capacity.
- › 29" to 34" pneumatic gas lift seat height adjustment.
- › Comfortable 14" diameter x 3-1/2" thick vinyl fabric over foam seat.
- › Contoured 12" x 6" x 2-1/2" thick vinyl over foam back.
- › Durable steel constructed seat control with dual 1" tubular steel back bars.
- › Back depth adjustment.
- › 1" chrome finished tubular legs with 18" diameter steel foot ring.



| Product # | Capacity (lbs) | Width (in) | Height (in) | Weight (lbs) |
|-----------|----------------|------------|-------------|--------------|
| JFC1011 | 300 | 14 | 44 | 24.02 |

FENDER COVER - HEAVYWEIGHT

- › Expanded 115 gauge thick vinyl material.
- › Grease and acid-resistant vinyl.
- › Full length sewn in tool ridge.
- › Textured grip back.
- › Binding around outside edge for added durability.



| Product # | Width (in) | Overall Length (in) | Weight (lbs) |
|-----------|------------|---------------------|--------------|
| JFCHD1B | 27 | 34-1/2 | 1.95 |



FENDER COVER - LIGHTWEIGHT

- › Expanded 70 gauge vinyl material.
- › Grease and acid-resistant vinyl.
- › Full length sewn in tool ridge.

| Product # | Width (in) | Overall Length (in) | Weight (lbs) |
|-----------|------------|---------------------|--------------|
| JFCR2B | 27 | 34-1/2 | 0.95 |



2 PACK FENDER COVER

- › Plasticized vinyl-coated fender covers (2).
- › Sturdy foam construction.
- › Die-cut finished edge.

| Product # | Width (in) | Overall Length (in) | Weight (lbs) |
|-----------|------------|---------------------|--------------|
| JFC100 | 24 | 36 | 2.79 |



TWIN ANGLE LIGHT

- › Ergonomically designed body style.
- › Comes with two premium 13W bulbs.
- › 25' premium cord.
- › Improved lens design allows for easy bulb changing.
- › Internal ballast.
- › Magnetic holder included.



| Product # | Voltage | Lumens | Width (in) | Height (in) | Cord Length | Overall Length (in) | Weight (lbs) |
|-----------|---------|--------------------|------------|-------------|-------------|---------------------|--------------|
| JFC98468 | 120V | Rated up to 1660lm | 4 | 2-1/2 | 25-foot | 13-1/2 | 3.80 |

RECHARGEABLE LED CORDLESS SHOP LIGHT

- › Molded-in handle grip and lens edge guard.
- › Polycarbonate high-strength hook that swivels to keep light on the subject and away from your eyes.
- › 30 super bright 100,000 hour flood light style LEDs.
- › 1,000 charge cycle NiMh battery pack with 10-hour cordless use between charging.
- › Smart charge indicator LED.
- › 12V DC and 120V AC chargers included.



| Product # | Voltage | Lumens | Width (in) | Height (in) | Overall Length (in) | Weight (lbs) | Battery Type |
|-----------|----------|--------|------------|-------------|---------------------|--------------|-----------------------|
| JFC4000 | 12V/110V | 174.3 | 2-1/4 | 3 | 12 | 1.60 | NiMh internal battery |

ALUMINUM LED/UV DUAL LIGHT

- › Tough aluminum housing is anodized inside and out.
- › Patterned, rugged handle for firmer grip and resists corrosion.
- › Up to 100,000 hours of service.
- › High-impact polycarbonate lens.
- › Magnetic base.
- › UL AC charger and 12V cigarette charger included.
- › 1.5W LED flashlight head rated at 130 lumens.
- › 33 bright white LED rated at 80 lumens.
- › 20 UV LED rated at 390NM.



| Product # | Diameter Maximum (in) | Voltage | Lumens | Overall Length (in) | Weight (lbs) | Battery Type |
|-----------|-----------------------|----------|--|---------------------|--------------|-----------------------|
| JFC98266D | 1-45/64 | 12V/110V | 1.5W LED flashlight head rated at 130 lumens; 33 bright white LED rated at 80 lumens; 20 UV LED rated at 390NM | 15-1/2 | 1.05 | NiMh internal battery |

CONTINUOUS SHOT AIR GREASE GUN

- › Heavy-duty cast aluminum body with comfortable cushion-grip.
- › 3-way loading: bulk, 14 oz. cartridge, and filler pump.
- › Bleeder valve for purging unwanted air.
- › 40:1 ratio.
- › Output per stroke: 2 ml.
- › Output pressure: 3,600 PSI.



| Product # | Overall Length (in) | Weight (lbs) |
|-----------|---------------------|--------------|
| JFCG3HD | 16-3/32 | 4.05 |

HEAVY-DUTY SINGLE SHOT AIR GREASE GUN

- › Heavy-duty composite body with comfortable cushion-grip.
- › 3-way loading: bulk, 14-oz. cartridge, and filler pump.
- › Bleeder valve for purging unwanted air.
- › 40:1 ratio.
- › Output per stroke: 2 ml.
- › Output pressure: 3,600 PSI.



| Product # | Overall Length (in) | Weight (lbs) |
|-----------|---------------------|--------------|
| JFC53HD | 16-13/32 | 3.22 |

HEAVY-DUTY PISTOL GRIP GREASE GUN

- › 3-way filling: bulk, cartridge, or filler pump.
- › 16 oz. bulk fill.
- › 14 oz. standard cartridge.
- › Heavy-duty 1.7 mm thick seamless barrel to avoid dents.
- › Aluminum head reduces weight.
- › Heavy-duty flexible 18" nylon hose and 6" metal spout for easy use.
- › Output pressure: 3,600 PSI.



| Product # | Overall Length (in) | Weight (lbs) |
|-----------|---------------------|--------------|
| JFC33HD | 16 | 3.86 |



SUCTION GUN

- › Heavy-duty, 16 oz. capacity, 1.7 mm thick seamless barrel with textured finish.
- › 12" clear flexible tube.
- › Heavy-duty "T" handle with finger grooves for easy use.



| Product # | Overall Length (in) | Weight (lbs) |
|----------------|---------------------|--------------|
| JFC19HD | 14-51/64 | 2.35 |

7 PIECE VACUUM/PRESSURE HAND PUMP KIT

- › One-person brake bleeding kit, accessories are included to perform multiple vacuum and pressure tests on vehicle.
- › Includes compound vacuum/pressure gauge with rubber protective boot.
- › Switch between vacuum/ pressure at the turn of a switch – produces and measures vacuum or pressure with equal performance and precision.
- › Single-hand vacuum/pressure release action allows multiple tests without disconnection.
- › Dual hand pump has ergonomically designed handle for ease of operation.



| Product # | Width (in) | Height (in) | Overall Length (in) | Weight (lbs) |
|-----------------|------------|-------------|---------------------|--------------|
| JFC5000K | 10-3/32 | 4-51/64 | 13-13/64 | 5.58 |

BEARING PACKER

- › Flushes out old grease and re-packs bearings with less mess.
- › Fits bearings up to 3-1/2" (outer diameter).
- › Grease stays in tool cavity and off of your hands.
- › Simplifies the process: Place the bearing on the piston; press down the cap until the old grease is forced out and the new grease shows on top.



| Product # | Height (in) | Overall Length (in) | Weight (lbs) |
|---------------|-------------|---------------------|--------------|
| JFC300 | 4 | 6 | 1.00 |

9 PIECE WHEEL TORQUE MASTER KIT

- › Designed for use with a 1/2" drive impact wrench.
- › Comes with a color wall chart and custom case.



| Product # | Width (in) | Overall Length (in) | Weight (lbs) |
|----------------|------------|---------------------|--------------|
| JFC1503 | 10-45/64 | 13-19/32 | 9.70 |

5 PIECE WHEEL TORQUE EXTENSION KIT

- › Designed to torque wheel nuts on foreign and domestic cars and light trucks.
- › For use with thin wall or impact lug nut sockets.
- › Includes wall chart and custom case.

| Product # | Width (in) | Overall Length (in) | Weight (lbs) |
|----------------|------------|---------------------|--------------|
| JFC1463 | 6-45/64 | 10-45/64 | 3.59 |



4 PIECE AMERICAN CAR WHEEL TORQUE KIT

- › For work on American makes of cars, light trucks, and vans.
- › Includes four torque sockets.

| Product # | Width (in) | Overall Length (in) | Weight (lbs) |
|----------------|------------|---------------------|--------------|
| JFC1553 | 10-45/64 | 12-19/64 | 4.82 |



6 PIECE UNIVERSAL DISC BRAKE CALIPER SET

Product #: JFC2500MA

- › Universal brake caliper tool set assists in the replacement of pads on most vehicles with 4-wheel disc brakes.
- › Tool and adapters rotate brake pistons into calipers allowing clearance for newer, thicker brake pads.
- › Five disc sizes to fit most domestic and foreign vehicles, covers most: Honda, Ford, GM, Jaguar, Mazda, Audi, Chrysler, Nissan, Toyota, VW, and Subaru 4-wheel disc brake systems.
- › Hex end threaded bolt pushes adapter into caliper; smooth operation with wrench or socket.
- › Rugged blow-molded case.
- › Weight (lbs): 4.56



9 BLADE STANDARD FEELER GAUGE SET

Product #: J000A

- › Contains 9 short 3 inch blades in steel holder.
- › Sizes: .003", .004", .005", .006", .008", .010", .012", .015", .018".
- › Blades etched with both decimal size and metric equivalent.
- › Weight (lbs): 0.07

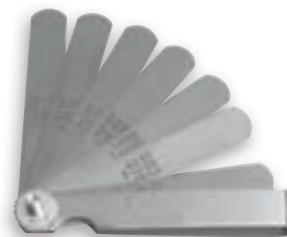



9 BLADE METRIC FEELER GAUGE SET

METRIC



Product #: J00MM9

- › 1/2" x 3" metric blades in steel holder.
- › Sizes: 0.06 mm, 0.10 mm, 0.15 mm, 0.20 mm, 0.30 mm, 0.35 mm, 0.40 mm, 0.50 mm, 0.60 mm.
- › Weight (lbs): 0.09



15 BLADE METRIC FEELER GAUGE SET

METRIC



Product #: J00MM15

- › 1/2" x 3" metric blades in steel holder.
- › Sizes: 0.06 mm, 0.07 mm, 0.08 mm, 0.10 mm, 0.15 mm, 0.20 mm, 0.25 mm, 0.30 mm, 0.35 mm, 0.40 mm, 0.45 mm, 0.50 mm, 0.55 mm, 0.60 mm, 0.70 mm.
- › Weight (lbs): 0.13



25 BLADE MASTER FEELER GAUGE SET



Product #: J000AA

- › 1/2" x 3" blades in steel holder.
- › Sizes: .0015" thru .040" except .019".
- › Blades etched with both decimal size and metric equivalent.
- › Weight (lbs): 0.19



25 BLADE METRIC FEELER GAUGE SET

METRIC



Product #: J00MM25

- › 1/2" x 3" metric blades in steel holder.
- › Sizes: 0.04 mm, 0.05 mm, 0.06 mm, 0.07 mm, 0.08 mm, 0.09 mm, 0.10 mm, 0.15 mm, 0.20 mm, 0.25 mm, 0.30 mm, 0.35 mm, 0.40 mm, 0.45 mm, 0.50 mm, 0.55 mm, 0.60 mm, 0.65 mm, 0.70 mm, 0.75 mm, 0.80 mm, 0.85 mm, 0.90 mm, 0.95 mm, 1.00 mm.
- › Weight (lbs): 0.22



22 BLADE STEP CUT FEELER GAUGE SET

Product #: **J000N**

- › "Go / no-go" 1/2" x 3-5/16" blades in steel holder.
- › Each blade has two different thicknesses.
- › Sizes: .004/.006", .005/.007", .006/.008", .007/.009", .008/.010", .009/.011", .010/.012", .011/.013", .012/.014", .013/.015", .014/.016", .015/.017", .016/.018", .017/.019", .018/.020", .019/.021", .020/.022", .021/.023", .022/.024", .023/.025", .024/.026", .025/.027".
- › Blades etched with both decimal size and metric equivalent.
- › Weight (lbs): 0.19



11 BLADE BENT FEELER GAUGE SET

Product #: **J000M**

- › 1/2" x 4" blades with a 1" bend in steel holder.
- › Sizes: .006", .008", .010", .011", .012", .013", .014", .015", .018", .019", .020".
- › Blades etched with both decimal size and metric equivalent.
- › Blades are offset at a right angle to help protect hands from a hot manifold while setting an overhead valve.
- › Weight (lbs): 0.13



12 BLADE LONG FEELER GAUGE SET

Product #: **J000SL**

- › 1/2" x 12" blades in steel holder.
- › Sizes: .0015", .002", .003", .004", .005", .006", .008", .010", .012", .014", .015", .020".
- › Blades etched with both decimal size and metric equivalent.
- › Weight (lbs): 0.30



25 BLADE LONG FEELER GAUGE SET

Product #: **J000TL**

- › 1/2" x 12" blades in steel holder.
- › Sizes: .0015", .002", .003", .004", .005", .006", .007", .008", .009", .010", .011", .012", .013", .014", .015", .016", .017", .018", .019", .020", .021", .025", .027", .030", .040".
- › Blades etched with both decimal size and metric equivalent.
- › Weight (lbs): 0.72

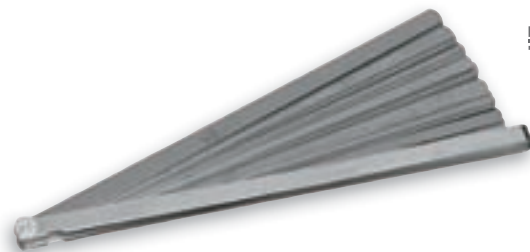

6 BLADE NON-MAGNETIC FEELER GAUGE SET

Product #: **J000BR**

- › Contains non-magnetic brass feeler blades for checking the air gap in electronic ignition systems for all weather conditions.
- › 1/2" x 3" blades in steel holder.
- › Sizes: .006", .008", .010", .012", .014", .016".
- › Blades etched with both decimal size and metric equivalent.
- › Weight (lbs): 0.08



SHORT BLADE HOLDER

Product #: **J000C**

- › Large enough to accommodate all 26 short blades.
- › Weight (lbs): 0.05



SHORT BLADE FEELER GAUGES

| Product # | Blade Thickness (in) | Weight (lbs) |
|--------------|----------------------|--------------|
| J0015 | 0.0015 | 0.01 |
| J002 | 0.002 | 0.01 |
| J003 | 0.003 | 0.01 |
| J004 | 0.004 | 0.04 |
| J005 | 0.005 | 0.01 |
| J006 | 0.006 | 0.01 |
| J007 | 0.007 | 0.01 |
| J008 | 0.008 | 0.02 |
| J009 | 0.009 | 0.01 |
| J010 | 0.010 | 0.02 |



LONG BLADE FEELER GAUGES

| Product # | Blade Thickness (in) | Weight (lbs) |
|---------------|----------------------|--------------|
| J0015L | 0.0015 | 0.01 |
| J002L | 0.002 | 0.01 |
| J003L | 0.003 | 0.03 |
| J004L | 0.004 | 0.01 |
| J005L | 0.005 | 0.01 |
| J006L | 0.006 | 0.02 |
| J008L | 0.008 | 0.02 |
| J010L | 0.010 | 0.02 |
| J015L | 0.015 | 0.03 |



10 BLADE IGNITION FEELER GAUGE SET

Product #: **J000D**

- › 1/4" x 1-3/4" blades in steel holder.
- › Sizes: .013", .015", .017", .018", .020", .025", .030", .032", .035", .040".
- › Blades etched with both decimal size and metric equivalent.
- › Weight (lbs): 0.06



16 BLADE OVERHEAD VALVE FEELER GAUGE SET

Product #: **J000R**

- › 1/2" wide bent gauges for setting overhead valves.
- › Sizes: .009", .010", .011", .014", .015", .016", .017", .018", .019", .020", .021", .023", .024", .025", .026", .027".
- › Blades are bent at a 45° angle to help protect hands from a hot manifold while setting an overhead valve.
- › Blades etched with both decimal size and metric equivalent.
- › Weight (lbs): 0.25



HIGH ENERGY SPARK PLUG GAP GAUGE SET

Product #: **J000J**

- › For use in setting gaps and spark plugs with high energy ignition systems.
- › Includes blade holder, electrode bender and six bent wire gauges in sizes .044", .045", .050", .054", .060", .080".
- › Gauges marked with both decimal size and metric equivalent.
- › Weight (lbs): 0.08



SPARK PLUG GAP GAUGE SET

Product #: **J000K**

- › Spark plug electrode bender and eight bent wire gauges in sizes .020", .022", .025", .027", .028", .030", .035", .040".
- › Gauges marked with both decimal size and metric equivalent.
- › Weight (lbs): 0.07



FLEXIBLE RETRIEVING AND HOLDING TOOLS

- › Designed to position or retrieve small objects.
- › Spring-loaded plunger actuates jaws at end of flexible casing.

| Product # | Overall Length (in) | Weight (lbs) |
|--------------|---------------------|--------------|
| J2344 | 13-1/2 | 0.19 |
| J2345 | 23-1/2 | 0.26 |





FLEXIBLE MAGNETIC RETRIEVING TOOLS

- › Retrieves small objects from hard-to-reach places.
- › Push button allows reaching an object before energizing the magnet.



| Product # | Lift Power (lbs) | Overall Length (in) | Weight (lbs) |
|--------------|------------------|---------------------|--------------|
| J2377 | 1.50 | 19-1/2 | 0.27 |
| J2378 | 3.00 | 24-1/2 | 0.37 |

POCKET MAGNETIC RETRIEVING TOOLS

- › J2375 includes versatile telescoping handle and all-angle ball joint.
- › J2376A has an aluminum head that contains a neodymium magnet that can lift up to 1-1/2 lbs., all angle ball joint, and a pocket clip.



J2375



J2376A

| Product # | Overall Length (in) | Weight (lbs) |
|---------------|---------------------|--------------|
| J2375 | 16-3/4 to 26-3/4 | 0.40 |
| J2376A | 8 | 0.08 |

INSPECTION MIRRORS

- › Versatile all-angle ball joint.
- › Features telescoping handle (J2372 and J2373).
- › With pocket clip (J2373).



J2374



J2371



J2373

| Product # | Mirror Shape | Mirror Size (L x W in) | Mirror Diameter (in) | Overall Length (in) | Weight (lbs) |
|--------------|--------------|------------------------|----------------------|---------------------|--------------|
| J2370 | Circular | - | 7/8 | 7-1/2 | 0.08 |
| J2374 | Circular | - | 1-1/4 | 8 | 0.09 |
| J2371 | Oval | 1 x 2 | - | 8-3/4 | 0.08 |
| J2372 | Circular | - | 2-1/4 | 10 to 14 | 0.25 |
| J2373 | Rectangular | 2-1/8 x 3-1/2 | - | 11-1/4 to 15-1/2 | 0.30 |

ALL-PURPOSE BRAKE PLIERS

- › Easily installs and removes brake shoe retaining spring on drum brakes.
- › Socket end removes spring from anchor stud.
- › Notched and installs spring on anchor.



| Product # | Overall Length (in) | Weight (lbs) |
|-------------|---------------------|--------------|
| J217 | 12-7/8 | 1.05 |

FACOM® STUD EXTRACTORS EXTERNAL CAM/KNURL TYPE

- › Turn extractor with a ratchet, wrench, or socket to engage the cam and stud, then pull out stud.
- › 1/2" and 1/4" drive capacity.
- › Knurled wheel grips stud when pressure is applied.
- › Hex drive can be driven with wrench or ratcheting tool.
- › Ideal for bolts with rusted, corroded, or stripped threads.
- › Heavy-duty finish.



| Product # | Drive Size (in) | Capacity (in) | Capacity (mm) | Overall Length (in) | Weight (lbs) |
|-------------------|-----------------|---------------|---------------|---------------------|--------------|
| FA-286A | 1/2 | 3/4 | 20 | 2-5/32 | 0.86 |
| FA-286A.PL | 3/4 | 1 | 27 | 2-15/16 | 2.11 |

FACOM® 5 PIECE STUD EXTRACTOR ROLLER SET



Product #: FA-287B.JS5

- › 5 Stud drivers for sizes M6, M7, M8, M9 and M10.
- › Supplied in a CKS rack.
- › Weight (lbs): 2.58



| Contents | Description | Overall Length (in) |
|------------|--|---------------------|
| FA-287B.6 | Stud Extractor, Internal Cam/Roller Type M6 | 2-3/4 |
| FA-287B.7 | Stud Extractor, Internal Cam/Roller Type M7 | 2-3/4 |
| FA-287B.8 | Stud Extractor, Internal Cam/Roller Type M8 | 2-3/4 |
| FA-287B.9 | Stud Extractor, Internal Cam/Roller Type M9 | 3-5/32 |
| FA-287B.10 | Stud Extractor, Internal Cam/Roller Type M10 | 3-5/32 |

FACOM® STUD EXTRACTORS INTERNAL CAM/ROLLER TYPE



- › Designed to grip studs using cam assemblies.
- › Capacity ranging from 6-16 mm.
- › 1/2" drive.
- › Full polish finish.



| Product # | Drive Size (in) | Capacity (in) | Capacity (mm) | Overall Length (in) | Weight (lbs) |
|-------------------|-----------------|---------------|---------------|---------------------|--------------|
| FA-287B.6 | 1/2 | 13/32 | 6 | 2-3/4 | 0.38 |
| FA-287B.7 | 1/2 | 15/32 | 7 | 2-3/4 | 0.38 |
| FA-287B.8 | 1/2 | 9/16 | 8 | 2-3/4 | 0.38 |
| FA-287B.9 | 1/2 | 5/8 | 9 | 3-5/32 | 0.56 |
| FA-287B.10 | 1/2 | 1/4 | 10 | 3-5/32 | 0.55 |
| FA-287B.12 | 1/2 | 9/32 | 12 | 3-5/32 | 0.53 |
| FA-287B.14 | 1/2 | 5/16 | 14 | 2-15/16 | 0.76 |
| FA-287B.16 | 1/2 | 11/32 | 16 | 2-15/16 | 0.69 |



FACOM® 3 PIECE NUT SPLITTER



Product #: **FA-289**

- › Includes 19 mm and 30 mm Nut Splitters and Spare Screw.
- › Supplied in a plastic tray.
- › Weight (lbs): 1.19



FACOM® NUT SPLITTERS



- › Removes frozen, corroded, or rusted nuts.
- › Will not damage bolt threads.



| Product # | Min. Screw Size (in) | Max. Screw Size (in) | Internal Diameter (in) | Internal Diameter (mm) | External Diameter (in) | External Diameter (mm) | Overall Length (in) | Weight (lbs) |
|------------------|----------------------|----------------------|------------------------|------------------------|------------------------|------------------------|---------------------|--------------|
| FA-289.19 | 2 | 8 | 3/4 | 19 | 1-1/4 | 31 | 4-11/32 | 0.59 |
| FA-289.36 | 16 | 20 | 1-7/16 | 36 | 2-7/16 | 62 | 8-1/16 | 2.50 |

FACOM® NUT SPLITTERS - SPARE SCREW



| Product # | Overall Length (in) | Weight (lbs) |
|------------------|---------------------|--------------|
| FA-289.V3 | 7-15/32 | 1.77 |



FACOM® MONKEY WRENCHES



- › Satin finish provides corrosion resistance and a slip-resistant grip.
- › Sturdy, wide-opening tools for heavy-duty work on farms and building sites.
- › Fixed jaw/handle and worm gear made from hardened steel.
- › Smooth jaw faces help prevent marring of fastener surfaces.

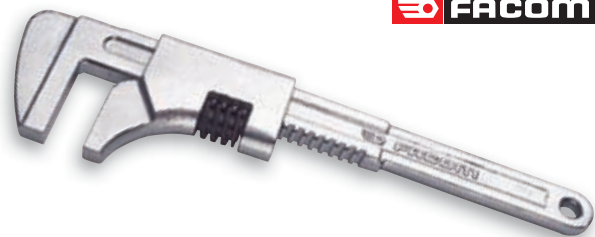

| Product # | Size (in) | Jaw Depth (in) | Jaw Thickness (in) | Height (in) | Overall Length (in) | Weight (lbs) |
|-------------------|-----------|----------------|--------------------|-------------|---------------------|--------------|
| FA-105.230 | 2-3/8 | 1-25/32 | 25/32 | 19/32 | 9-1/16 | 1.15 |
| FA-105.280 | 2-3/4 | 1-11/32 | 21/32 | 25/32 | 11-1/32 | 1.79 |
| FA-105.375 | 3-1/8 | 1-25/32 | 7/8 | 7/8 | 14-23/32 | 3.36 |



10 PIECE SCREW EXTRACTOR SET

Product #: J9500B

- › Drive into end of broken pipe or fitting.
- › Use tap holder or wrench on extractor to turn out broken part.
- › Size stamped on extractor refers to drill bit size to be used with that extractor.
- › Weight (lbs): 4.50

| Contents | Description | Overall Length (in) |
|----------|--------------------------|---------------------|
| J9521 | Screw, Extractor 1/8" | 2-5/16 |
| J9522 | Screw, Extractor 3/16" | 2-5/8 |
| J9523 | Screw, Extractor 7/32" | 2-7/8 |
| J9524 | Screw, Extractor 5/16" | 3 |
| J9525 | Screw, Extractor 3/8" | 3-1/4 |
| J9525B | Screw, Extractor 15/32" | 3-7/8 |
| J9526 | Screw, Extractor 9/16" | 4-1/4 |
| J9527 | Screw, Extractor 21/32" | 4-7/8 |
| J9528 | Screw, Extractor 13/16" | 5-3/8 |
| J9529 | Screw, Extractor 1-1/16" | 5-1/2 |



5 PIECE SCREW EXTRACTOR SET

Product #: J9500A

- › Drive into end of broken pipe or fitting.
- › Use tap holder or wrench on extractor to turn out broken part.
- › Size stamped on extractor refers to drill bit size to be used with that extractor.
- › Weight (lbs): 0.28

| Contents | Description | Overall Length (in) |
|----------|------------------------|---------------------|
| J9521 | Screw, Extractor 1/8" | 2-5/16 |
| J9522 | Screw, Extractor 3/16" | 2-5/8 |
| J9523 | Screw, Extractor 7/32" | 2-7/8 |
| J9524 | Screw, Extractor 5/16" | 3 |
| J9525 | Screw, Extractor 3/8" | 3-1/4 |
| J25TR49C | Tool Roll 5 Pockets | 6-3/32 |



SCREW EXTRACTORS

- › Drive into end of broken pipe or fitting.
- › Use tap holder or wrench on extractor to turn out broken part.
- › Size stamped on extractor refers to drill bit size to be used with that extractor.



| Product # | U.S.S. (in) | Drill Size (in) | Diameter Minimum (in) | Diameter Maximum (in) | Overall Length (in) | Weight (lbs) |
|---------------|--------------|-----------------|-----------------------|-----------------------|---------------------|--------------|
| J9521 | 1/4, 5/16 | 1/8 | 1/8 | 3/16 | 2-5/16 | 0.02 |
| J9522 | 3/8 | 3/16 | 11/64 | 3/16 | 2-5/8 | 0.02 |
| J9523 | 7/16 | 7/32 | 13/64 | 1/4 | 2-7/8 | 0.05 |
| J9524 | 1/2, 9/16 | 5/16 | 19/64 | 5/16 | 3 | 0.07 |
| J9525 | 5/8 | 3/8 | 11/32 | 3/8 | 3-1/4 | 0.12 |
| J9525B | 3/4 | 15/32 | 1/8 | 1/8 | 3-7/8 | 0.18 |
| J9526 | 7/8 | 9/16 | 1/2 | 1/2 | 4-1/4 | 0.29 |
| J9527 | 1, 1-1/8 | 21/32 | 19/32 | 5/8 | 4-7/8 | 0.47 |
| J9528 | 1-1/4, 1-3/8 | 13/16 | 23/32 | 3/4 | 5-3/8 | 0.72 |
| J9529 | 1-1/2 | 1-1/16 | 31/32 | 1 | 5-1/2 | 1.30 |

10 PIECE BOLT EXTRACTOR SOCKET SET

Product #: **J69X00**

- ▶ The working end has a helical shaped flute to help grip rounded fasteners, round head bolts, and pan head screws.
- ▶ 3/4" Drive size.
- ▶ Weight (lbs): 0.86



| Contents | Description | Overall Length (in) |
|----------|--------------------------------------|---------------------|
| J69X09 | Extractor, Socket 7 mm, 1/4", 9/32" | 1-1/16 |
| J69X10 | Extractor, Socket 8 mm, 5/16" | 1-1/16 |
| J69X11 | Extractor, Socket 9 mm, 11/32" | 1-1/16 |
| J69X12 | Extractor, Socket 3/8" | 1-1/16 |
| J69X13 | Extractor, Socket 10 mm, 13/32" | 1-1/16 |
| J69X14 | Extractor, Socket 11 mm, 7/16" | 1-1/16 |
| J69X15 | Extractor, Socket 12 mm, 15/32" | 1-1/16 |
| J69X16 | Extractor, Socket 13 mm, 1/2" | 1-1/16 |
| J69X18 | Extractor, Socket 14 mm, 9/16" | 1-1/16 |
| J69X20 | Extractor, Socket 15 mm, 16 mm, 5/8" | 1-1/16 |



FEATURES AND BENEFITS – BOLT EXTRACTORS

- ▶ Easily remove rusted, rounded or damaged nuts and bolts.
- ▶ 18-30 teeth in a hexagonal configuration help grip rounded hexagonal fasteners, round head bolts and pan head screws.
- ▶ Low profile design helps gain access to fasteners in tight spaces.
- ▶ The non-working end can be turned with wrenches or sockets.
- ▶ Can be used in combination with other drive tools (such as extensions, universal joints or ratchets with short arc swings) to help reach fasteners in difficult locations.
- ▶ Through-hole design helps gain access to fasteners at the end of long bolts or studs.
- ▶ Sizes range from 1/4" - 5/8" and 7 - 16 mm. Each socket can turn multiple fastener sizes.
- ▶ Can be used on fractional or metric fasteners.

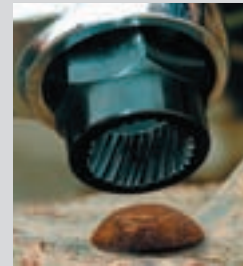

- ▶ Easily remove rusted, rounded or damaged nuts and bolts.

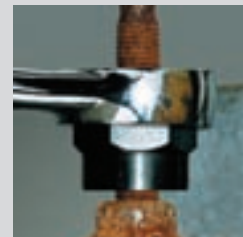

- ▶ Through-hole design helps gain access to fasteners at the end of long bolts or studs.

3/8" DRIVE 13 PIECE HAND IMPACT DRIVER SET

Product #: **J7099A**



- › Designed to loosen hard to turn bolts and nuts.
- › Hand impact driver has heavy-duty spring for added torque.
- › Popular interchangeable bits are packaged in plastic blow-molded box for easy storage.
- › Weight (lbs): 2.36

| Contents | Description | Overall Length (in) |
|----------|-------------------------------------|---------------------|
| J7099 | Driver, Hand Impact 3/8" DR 5-1/2" | 5-1/2 |
| J60002 | Bit, Insert #1 Phillips® 1/4" Hex | 1 |
| J60008 | Bit, Insert #2 Phillips® 1/4" Hex | 1 |
| J60020 | Bit, Insert #3 Phillips® 1/4" Hex | 1 |
| J60202 | Bit, Insert 3/16" Slotted 1/4" Hex | 1 |
| J60208 | Bit, Insert 9/32" Slotted 1/4" Hex | 1 |
| J60050 | Bit, Insert #1 Phillips® 5/16" Hex | 1-1/4 |
| J60052 | Bit, Insert #2 Phillips® 5/16" Hex | 1-1/4 |
| J60054 | Bit, Insert #3 Phillips® 5/16" Hex | 1-1/4 |
| J60256 | Bit, Insert 3/16" Slotted 5/16" Hex | 1-1/2 |
| J60262 | Bit, Insert 9/32" Slotted 5/16" Hex | 1-1/2 |
| J6930 | Bit, Holder Power 3/8" DR 5/16" Hex | 1-5/16 |
| J6931 | Bit, Holder Power 3/8" DR 1/4" Hex | 1-1/4 |



BATTERY CABLE AND SMALL BEARING PULLER

- › Uses toggle-type action to grip onto all standard post battery terminals.
- › Pulls small bearings and gears with 1" reach and spread.

| Product # | Weight (lbs) |
|--------------|--------------|
| J4041 | 0.65 |



PULLEY PULLER

- › For removing single and two-groove pulleys from alternators and power steering pumps.
- › Two position yoke permits pulling bearings on both standard and heavy-duty alternators.

| Product # | Weight (lbs) |
|--------------|--------------|
| J4053 | 2.10 |

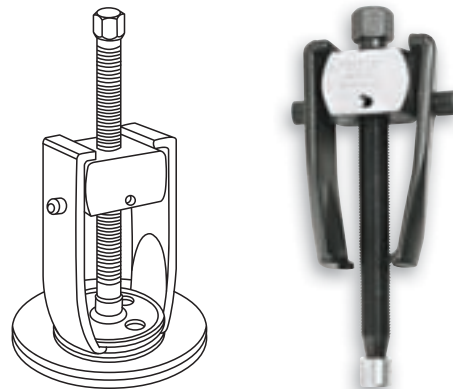



CLOSE QUARTERS PILOT BEARING PULLER

- › Designed to pull flywheel pilot bearings with inside diameters 1/2" to 1-1/2".
- › Removes bearings and bushings from starters, generators, magnetos, and small electric motors.



| Product # | Weight (lbs) |
|-----------|--------------|
| J4059 | 2.30 |

10-WAY PROTO-EASE™ ADVANTAGE SLIDE HAMMER PULLER SET

Product #: J5040

- › Slide hammer puller set packaged in a convenient plastic blow-molded carrying/storage case.
- › Weight (lbs): 25.00

| Description | Qty. |
|-----------------------------------|------|
| Hex Jam Nut (5/16"-24) | 3 |
| Hex Jam Nut (5/8"-18) | 1 |
| Hex Head Cap Screw (5/16"-24) | 3 |
| Puller Head | 1 |
| Adjusting Cone | 1 |
| Forcing Screw | 1 |
| 2-Way Crossarm | 1 |
| Pulling Hook | 1 |
| Pulling Adapter-Machine | 1 |
| Pilot Bearing Puller Jaw | 3 |
| 5 lbs. Slide Hammer | 1 |
| Puller Arm | 1 |
| Medium Puller Jaw | 3 |
| Long Puller Jaw | 3 |
| Self Tapping Screw | 1 |
| Adapter For Adjustable Jaw Wrench | 1 |
| Retainer | 1 |
| Shank and Tee Bar Assembly | 1 |
| Sleeve (5/8"-18) | 1 |
| Forcing Screw | 1 |
| Front Hub Remover | 1 |
| Blow-Molded Case | 1 |



REVERSIBLE JAW SLIDE HAMMER PULLER

Product #: J5049

- › Versatile puller which will accomplish many pulling jobs involving gears, bearings, outer races, grease retainers, oil seals, etc.
- › Either two or three puller jaws may be used to handle "inside" pulling jobs such as bearing cups and outer racers, as well as regular "outside" pulling jobs.
- › The 5 lbs. slide hammer can be removed and used independently.
- › Weight (lbs): 11.00
- › Overall Length: 27".



| 2-Jaw Spread | | | | 3-Jaw Spread | | | |
|--------------|--------|---------|--------|--------------|--------|---------|--------|
| Inside | | Outside | | Inside | | Outside | |
| Min. | Max. | Min. | Max. | Min. | Max. | Min. | Max. |
| 1-1/4" | 3-1/2" | 1" | 4-1/2" | 1-1/2" | 4-1/4" | 1-1/2" | 4-1/2" |



PROTO

**INDUSTRY RUNS ON ELECTRICITY,
WHICH MAKES YOU A VITAL RELAY STATION.**

Proto® knows you keep the lights on. Our electrical line includes more than 300 specialized tools to cut, crimp, bend, move, or secure wire and cable – and do it easier, faster, and safer. We also know you can't shut down an entire plant to fix a breaker panel. That's why the centerpiece of our electrical line is an extensive set of 1,000-Volt Insulated Tools — screwdrivers, pliers, cutting tools, wrenches, drive tools and keys — wrapped with a thick layer of plastic insulation and individually tested to 1000 V AC and 1,500 V DC. It's industrial strength electrical. Just like you.

ELECTRICAL TOOLS



Facom® Insulated VE Diagonal Cutters

PROTO

25 PC ELECTRICIAN'S TOOL SET

Product #: **JTS-0025ELEC**



- › 25 Pieces.
- › Contains: 1 Wrench, 1 Striking and Struck Tool, 6 Pliers, 6 Screwdrivers, 11 Miscellaneous Tools.
- › Enhanced version of Proto® 90-732 Electrician's Tool Set.
- › Weight: 20 lbs.

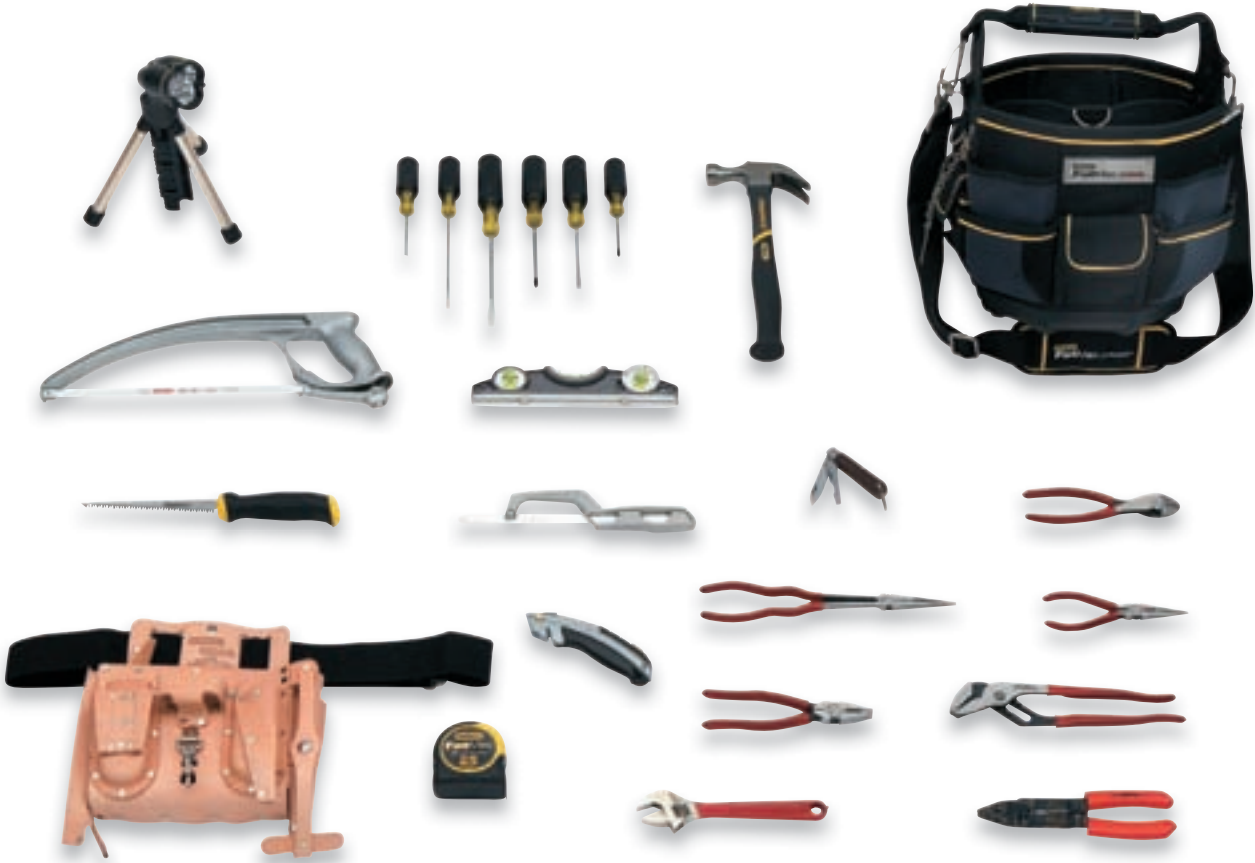

Representative Image; Contents May Differ

| Contents | Description |
|----------|---|
| J95230 | Belt, Wide Web 2" |
| 95-112W | Flashlight, Stanley® TriPod 20 LUMENS |
| 20-001 | Hacksaw, High Tension Low Profile 12" |
| 15-809 | Hacksaw, Metal Mini |
| 51-505 | Hammer, Jacketed Graphite Nailing CC 16 oz. |
| J18500 | Knife, Electricians 3-3/4" |
| 10-788 | Knife, QuickChange™ Retractable Blade Utility |
| 43-609 | Level, FatMax® Xtreme™ Torpedo 9" |
| J209G | Pliers, Diagonal Cutting with Grip 7-5/16" |
| J268G | Pliers, Lineman's with Grip 8-5/8" |

| Contents | Description |
|----------|--|
| J240G | Pliers, Needle-Nose Long Reach 11-9/16" |
| J226G | Pliers, Needle-Nose with Cutter 6-5/8" |
| J260SG | Pliers, Tongue and Groove 10-3/16" with Grip |
| J299 | Pliers, Wire Stripper/Crimper 8-1/2" |
| 20-556 | Saw, FatMax® Jab |
| 66-565P | Screwdriver, 6 PC Stanley® Vinyl Grip |
| 33-725 | Tape Rule, FatMax® 1-1/4" x 25' |
| 511150M | Tool Bag, FatMax® Technician 12" |
| J708G | Wrench, Adjustable, 8" Grip |



FACOM® 39 PIECE 1000V VSE



Product #: FC-2184C.VSE

- › For workshop or on-site electrical work.
- › Supplied in case.
- › Contains: 1 Wrench, 1 Striking and Struck Tools,
- › 6 Pliers, 6 Screwdrivers, 11 miscellaneous Tools.
- › Weight: 32.25 lbs.



Representative Image; Contents May Differ

| Contents | Description |
|----------------|---|
| FA-412.14AVSE | Cutter, Cable 1000V VSE 9 in |
| FA-414.45AVSE | Cutter, Cable RCH 1000V VSE 1-3/4 in Diagonal |
| FM-83.3AVSE | Hex Key, 1000V VSE 3 mm |
| FM-83.4AVSE | Hex Key, 1000V VSE 4 mm |
| FM-83.6AVSE | Hex Key, 1000V VSE 6 mm |
| FT-1820.AVSE | Knife, 1000V VSE 2-3/8" |
| FA-195.20AVSE | Pliers, Bentnose 1000V VSE 7-7/8" |
| FA-187.18AVSE | Pliers, Combo 1000V VSE 7-1/4" |
| FA-192.16AVSE | Pliers, Diagonal 1000V VSE 6-1/2" |
| FA-391.16AVSE | Pliers, Diagonal Cutter 1000V VSE 6-1/2" |
| FA-190.16AVSE | Pliers, Endcutter 1000V VSE 6-1/2" |
| FA-188.16AVSE | Pliers, Flatnose 1000V VSE 6-1/2" |
| FA-180.VSE | Pliers, Multigrip 1000V VSE 10" |
| FA-189.17AVSE | Pliers, Round Nose 1000V VSE 6-1/2" |
| FM-DELA.401.00 | Rule, Folding 2M |
| FW-A3.5X100VE | Screwdriver, 1000V 3.5 mm Slotted 7-7/8" |
| FW-A4X100VE | Screwdriver, 1000V 4 mm Slotted 7-7/8" |
| FW-A5.5X150VE | Screwdriver, 1000V 5.5 mm Slotted 10-1/8" |
| FW-A6.5X150VE | Screwdriver, 1000V 6.5 mm Slotted 10-1/2" |

| Contents | Description |
|---------------|--|
| FW-A8X150VE | Screwdriver, 1000V 8 mm Slotted 10-1/2" |
| FW-A10X200VE | Screwdriver, 1000V 10 mm Slotted 12-3/4" |
| FW-AP1X100VE | Screwdriver, 1000V PH1 |
| FW-AP2X125VE | Screwdriver, 1000V PH2 |
| FW-AD1X100VE | Screwdriver, 1000V PZ1 |
| FW-AD3X150VE | Screwdriver, 1000V PZ3 |
| FT-701A | Tester, Multifunction |
| FT-BV.5A | Tool Briefcase 2184CVSE |
| FA-194.17AVSE | Wire Stripper, 1000V VSE 6-1/2 in |
| FM-46.8AVSE | Wrench, Combination 1000V VSE 8 mm |
| FM-46.10AVSE | Wrench, Combination 1000V VSE 10 mm |
| FM-46.12AVSE | Wrench, Combination 1000V VSE 12 mm |
| FM-46.13AVSE | Wrench, Combination 1000V VSE 13 mm |
| FM-46.14AVSE | Wrench, Combination 1000V VSE 14 mm |
| FM-46.17AVSE | Wrench, Combination 1000V VSE 17 mm |
| FM-46.19AVSE | Wrench, Combination 1000V VSE 19 mm |
| FM-46.21AVSE | Wrench, Combination 1000V VSE 20 mm |
| FM-94T.8AVSE | Nut Driver, T-Handle 1000V VSE 8 mm |
| FM-94T.10AVSE | Nut Driver, T-Handle 1000V VSE 10 mm |
| FM-94T.13AVSE | Nut Driver, T-Handle 1000V VSE 13 mm |



FACOM® 40 PIECE 1000V VSE**Product #: FC-2187C.VSE**

- › Supplied in leather case.
- › Contains: 10 Sockets and Accessories, 9 Wrenches, 6 Pliers, 10 Screwdrivers, 6 Miscellaneous Tools.
- › Weight: 19.6 lbs.



Representative Image; Contents May Differ

| Contents | Description | Contents | Description |
|---------------|---|----------------|--------------------------------------|
| FM-RT.4AVSE | Socket, Hex Bit 1/4" DR 1000V VSE 4 mm | FW-AP1X100VE | Screwdriver, 1000V Round Bar #1 x 4" |
| FM-RT.5AVSE | Socket, Hex Bit 1/4" DR 1000V VSE 5 mm | FW-AP2X125VE | Screwdriver, 1000V Round Bar #2 x 5" |
| FM-RT.6AVSE | Socket, Hex Bit 1/4" DR 1000V VSE 6 mm | FM-R.10AVSE | Socket, 1/4" DR 1000V VSE 10 mm |
| FA-412.14AVSE | Cutter, Cable 1000V VSE 9" | FM-R.12AVSE | Socket, 1/4" DR 1000V VSE 12 mm |
| FT-R.210AVSE | Extension, 1/4" DR 1000V VSE 4.5" | FM-R.6AVSE | Socket, 1/4" DR 1000V VSE 6 mm |
| FT-BC.109VSE | Gloves, Leather Size 9" | FM-R.7AVSE | Socket, 1/4" DR 1000V VSE 7 mm |
| FM-83.3AVSE | Hex Key, 1000V VSE 3 mm | FM-R.8AVSE | Socket, 1/4" DR 1000V VSE 8 mm |
| FM-83.4AVSE | Hex Key, 1000V VSE 4 mm | FT-AV.HT1B | Scwdriver, Volt Test 90-480V |
| FM-83.6AVSE | Hex Key, 1000V VSE 6 mm | FT-701A | Tester, Multifunction |
| FA-187.18AVSE | Pliers, Combination 1000V VSE 7-1/4" | FT-BV.7A | Tool, Briefcase |
| FA-391.16AVSE | Pliers, Diagonal Cutters 1000V VSE 6-1/2" | FA-194.17AVSE | Wire Stripper, 1000V VSE 6-1/2" |
| FA-188.16AVSE | Pliers, Flat Nose 1000V VSE 6-1/2" | FA-113.10TAVSE | Wrench, Adjustable 1000V VSE 10" |
| FA-189.17AVSE | Pliers, Round Nose 1000V VSE 6-1/2" | FM-46.8AVSE | Wrench, Combination 1000V VSE 8 mm |
| FT-R.151AVSE | Ratchet, 1/4" DR 1000V VSE 4-7/8" | FM-46.10AVSE | Wrench, Combination 1000V VSE 10 mm |
| FW-A3.5X100VE | Screwdriver, 1000V 3.5 mm Slotted 7-7/8" | FM-46.11AVSE | Wrench, Combination 1000V VSE 11 mm |
| FW-A4X100VE | Screwdriver, 1000V 4 mm Slotted 7-7/8" | FM-46.12AVSE | Wrench, Combination 1000V VSE 12 mm |
| FW-A5.5X150VE | Screwdriver, 1000V 5.5 mm Slotted 10-1/8" | FM-46.13AVSE | Wrench, Combination 1000V VSE 13 mm |
| FW-A6.5X150VE | Screwdriver, 1000V 6.5 mm Slotted 10-1/2" | FM-46.14AVSE | Wrench, Combination 1000V VSE 14 mm |
| FW-ABX150VE | Screwdriver, 1000V 8 mm Slotted 10-1/2" | FM-46.17AVSE | Wrench, Combination 1000V VSE 17 mm |
| FW-APOX75VE | Screwdriver, 1000V PHO | FM-46.19AVSE | Wrench, Combination 1000V VSE 19 mm |



FACOM® 28 PIECE 1000V VSE



Product #: FC-2185C.VSE

- Supplied in a case with modular storage.
- Basic general purpose tools supplied in a plastic box.
- Spare capacity for additional tools.
- Contains: 10 Sockets and Accessories, 1 Wrench,
- 6 Pliers, 7 Screwdrivers, 4 Miscellaneous Tools
- Weight: 16.51 lbs.



Representative Image; Contents May Differ

| Contents | Description |
|----------------|---|
| FM-RT.4AVSE | Socket, Hex Bit 1/4" DR 1000V VSE 4 mm |
| FM-RT.5AVSE | Socket, Hex Bit 1/4" DR 1000V VSE 5 mm |
| FM-RT.6AVSE | Socket, Hex Bit 1/4" DR 1000V VSE 6 mm |
| FA-412.14AVSE | Cutter, Cable 1000V VSE 9" |
| FT-R.210AVSE | Extension, 1/4" DR 1000V VSE 4-1/2" |
| FT-BC.109VSE | Gloves, Leather Size 9" |
| FT-1820.AVSE | Knife, 1000V VSE 2-3/8" |
| FA-187.18AVSE | Pliers, Combination 1000V VSE 7-1/4" |
| FA-192.16AVSE | Pliers, Diagonal 1000V VSE 6-1/2" |
| FA-391.16AVSE | Pliers, Diagonal Cutters 1000V VSE 6-1/2" |
| FA-188.16AVSE | Pliers, Flat Nose 1000V VSE 6-1/2" |
| FT-R.151AVSE | Ratchet, 1/4" DR 1000V VSE 4-7/8" |
| FM-DELA.401.00 | Rule, Folding 2 mm |
| FW-A4X100VE | Screwdriver, 1000V 4 mm Slotted 7-7/8" |
| FW-A5.5X150VE | Screwdriver, 1000V 5.5 mm Slotted 10-1/8" |

| Contents | Description |
|----------------|---|
| FW-A6.5X150VE | Screwdriver, 1000V 6.5 mm Slotted 10-1/2" |
| FW-A8X150VE | Screwdriver, 1000V 8 mm Slotted 10-1/2" |
| FW-AP1X100VE | Screwdriver, 1000V PH1 |
| FW-AP2X125VE | Screwdriver, 1000V PH2 |
| FT-AV.HT1B | Screwdriver, Voltage Test 90-480V |
| FM-R.6AVSE | Socket, 1/4 DR 1000V VSE 6 mm |
| FM-R.7AVSE | Socket, 1/4 DR 1000V VSE 7 mm |
| FM-R.8AVSE | Socket, 1/4 DR 1000V VSE 8 mm |
| FM-R.10AVSE | Socket, 1/4 DR 1000V VSE 10 mm |
| FM-R.12AVSE | Socket, 1/4 DR 1000V VSE 12 mm |
| FA-194.17AVSE | Wire Stripper, 1000V VSE 6-1/2" |
| FA-113.10TAVSE | Wrench, Adjustable 1000V VSE 10" |
| FT-BP.P26 | Tool Box |



FACOM® 9 PIECE 1000V VSE



Product #: **FC-2180B.VSE**

- › Basic set for servicing workshop electrical gear.
- › Supplied in leather case.
- › Contains: 3 Screwdrivers, 4 Pliers, 2 Miscellaneous Tools.
- › Weight: 4.12 lbs.



Representative Image; Contents May Differ

| Contents | Description |
|---------------|---|
| FT-1820.AVSE | Knife, 1000V VSE 2-3/8" |
| FA-187.18AVSE | Pliers, Combination 1000V VSE 7-1/4" |
| FA-391.16AVSE | Pliers, Diagonal Cutters 1000V VSE 6-1/2" |
| FA-189.17AVSE | Pliers, Round Nose 1000V VSE 6-1/2" |
| FW-A4X100VE | Screwdriver, 1000V 4 mm Slotted 7-7/8" |

| Contents | Description |
|---------------|---|
| FW-A5.5X150VE | Screwdriver, 1000V 5.5 mm Slotted 10-1/8" |
| FW-AP1X100VE | Screwdriver, 1000V PH1 |
| FT-BV.100 | Tool Bag, Leather 2180BVSE |
| FA-194.17AVSE | Wire Stripper, 1000V VSE 6-1/2" |

FACOM® INSULATED RATCHETS



- › Sockets and accessories secured by spring-ball.
- › 2 color warning handle insulation - color changes from orange to yellow if insulation integrity compromised.
- › Insulated to 1000V AC or 1500 DC.

| Product # | Drive Size (in) | Overall Length (in) (L) | Weight (lbs) |
|---------------------|-----------------|-------------------------|--------------|
| FT-R.151AVSE | 1/4 | 4-7/8 | 0.28 |
| FT-J.151AVSE | 3/8 | 7 | 0.53 |
| FT-S.151AVSE | 1/2 | 10-3/8 | 1.24 |



FACOM® INSULATED T-HANDLES



- › Sockets and accessories secured by spring-ball.
- › 2 color warning handle insulation - color changes from orange to yellow if insulation integrity compromised.
- › Insulated to 1000V AC or 1500 DC.

| Product # | Drive Size (in) | Overall Length (in) (L) | Weight (lbs) |
|---------------------|-----------------|-------------------------|--------------|
| FT-J.121AVSE | 3/8 | 8 | 0.85 |
| FT-S.121AVSE | 1/2 | 8-17/64 | 1.15 |



FACOM® INSULATED EXTENSIONS



| Product # | Drive Size (in) | Overall Length (in) (L) | Weight (lbs) |
|--------------|-----------------|-------------------------|--------------|
| FT-R.210AVSE | 1/4 | 4-9/16 | 0.12 |
| FT-J.210AVSE | 3/8 | 5-29/32 | 0.33 |
| FT-J.215AVSE | 3/8 | 10-15/64 | 0.64 |
| FT-S.210AVSE | 1/2 | 5-45/64 | 0.55 |
| FT-S.215AVSE | 1/2 | 10-7/16 | 1.04 |



FACOM® 1/4" DRIVE 10 PIECE METRIC INSULATED SOCKET SET - 6 POINT



Product #: **FC-R.400AVSE**

- › 1000V AC and 1500DC Insulated Socket Set
- › Sockets: 6-12 mm
- › Hex Bit Sockets: 4-6 mm
- › Metric Size: Sockets: 6, 7, 8, 10, 12 mm
- › Accessories: Ratchet and 4-9/16 Inch Extension.
- › Weight (lbs): 1.47

| Contents | Description |
|--------------|--|
| FM-RT.4AVSE | Socket, Hex Bit 1/4 DR 1000V AC 4 mm 6 PT |
| FM-RT.5AVSE | Socket, Hex Bit 1/4" DR 1000V AC 5 mm 6 PT |
| FM-RT.6AVSE | Socket, Hex Bit 1/4" DR 1000V AC 6 mm 6 PT |
| FM-R.6AVSE | Socket, 1/4" DR 1000V AC 6 mm 6 PT |
| FM-R.7AVSE | Socket, 1/4" DR 1000V AC 7 mm 6 PT |
| FM-R.8AVSE | Socket, 1/4" DR 1000V AC 8 mm 6 PT |
| FM-R.10AVSE | Socket, 1/4" DR 1000V AC 10 mm 6 PT |
| FM-R.12AVSE | Socket, 1/4" DR 1000V AC 12 mm 6 PT |
| FT-R.151AVSE | Ratchet, 1/4" DR 1000V VSE 4-7/8" |
| FT-R.210AVSE | Extension, 1/4" DR 1000V VSE 4-9/16" |



FACOM® 3/8" DRIVE 9 PIECE INSULATED SOCKET SET - 12 POINT



Product #: **FC-J.401AVSE**

- › 1000V AC and 1500DC Insulated Socket Set
- › Metric Size Sockets: 8,10,11,12,13,14,15,17,19 mm
- › Accessories: Ratchet, T-Handle, and Extension. Weight (lbs): 3.2

| Contents | Description |
|--------------|---------------------------------------|
| FM-J.8AVSE | Socket, 3/8" DR 1000V VSE 8 mm |
| FM-J.10AVSE | Socket, 3/8" DR 1000V VSE 10 mm |
| FM-J.11AVSE | Socket, 3/8" DR 1000V VSE 11 mm |
| FM-J.12AVSE | Socket, 3/8" DR 1000V VSE 12 mm |
| FM-J.13AVSE | Socket, 3/8" DR 1000V VSE 13 mm |
| FM-J.14AVSE | Socket, 3/8" DR 1000V VSE 14 mm |
| FT-J.151AVSE | Ratchet, 3/8" DR 1000V VSE 7" |
| FT-J.210AVSE | Extension, 3/8" DR 1000V VSE 5-29/32" |
| FT-J.215AVSE | Extension, 3/8" DR 1000V VSE 10-1/4" |



FACOM® 3/8" DRIVE 17 PIECE INSULATED SOCKET SET - 12 POINT**Product #: FC-J.401AVSE**

- › 1000V AC and 1500DC Insulated Socket Set
- › Hex Bit Sockets: 4,5,6,7,8 mm
- › Metric Size Sockets: 8,10,11,12,13,14,15,17,19 mm
- › Accessories: Ratchet, T-Handle, and Extension. Weight (lbs): 4.96

| Contents | Description |
|--------------|--|
| FM-JT.4AVSE | Socket, Hex Bit 3/8" DR 1000V VSE 4 mm |
| FM-JT.5AVSE | Socket, Hex Bit 3/8" DR 1000V VSE 5 mm |
| FM-JT.6AVSE | Socket, Hex Bit 3/8" DR 1000V VSE 6 mm |
| FM-JT.7AVSE | Socket, Hex Bit 3/8" DR 1000V VSE 7 mm |
| FM-JT.8AVSE | Socket, Hex Bit 3/8" DR 1000V VSE 8 mm |
| FM-J.8AVSE | Socket, 3/8" DR 1000V VSE 8 mm |
| FM-J.10AVSE | Socket, 3/8" DR 1000V VSE 10 mm |
| FM-J.11AVSE | Socket, 3/8" DR 1000V VSE 11 mm |
| FM-J.12AVSE | Socket, 3/8" DR 1000V VSE 12 mm |
| FM-J.13AVSE | Socket, 3/8" DR 1000V VSE 13 mm |
| FM-J.14AVSE | Socket, 3/8" DR 1000V VSE 14 mm |
| FM-J.15AVSE | Socket, 3/8" DR 1000V VSE 15 mm |
| FM-J.17AVSE | Socket, 3/8" DR 1000V VSE 17 mm |
| FM-J.19AVSE | Socket, 3/8" DR 1000V VSE 19 mm |
| FT-J.121AVSE | T-Handle, 3/8" DR 1000V VSE |
| FT-J.151AVSE | Ratchet, 3/8" DR 1000V VSE 7" |
| FT-J.210AVSE | Extension, 3/8" DR 1000V VSE 5-29/32" |

**FACOM® 1/2" DRIVE 12 PIECE INSULATED SOCKET SET - 12 POINT****Product #: FC-S.400AVSE**

- › 1000V AC and 1500DC Insulated Socket Set
- › Metric Size Sockets: 8,10,11,12,13,14,15,17,19 mm
- › Accessories: Ratchet, T-Handle, and Extension. Weight (lbs): 5.4

| Contents | Description |
|--------------|-----------------------------------|
| FM-S.8AVSE | Socket, 1/2 DR 1000V SE 8 mm |
| FM-S.9AVSE | Socket, 1/2 DR 1000V SE 9 mm |
| FM-S.10AVSE | Socket, 1/2 DR 1000V SE 10 mm |
| FM-S.11AVSE | Socket, 1/2 DR 1000V SE 11 mm |
| FM-S.12AVSE | Socket, 1/2 DR 1000V SE 12 mm |
| FM-S.13AVSE | Socket, 1/2 DR 1000V SE 13 mm |
| FM-S.14AVSE | Socket, 1/2 DR 1000V SE 14 mm |
| FM-S.17AVSE | Socket, 1/2 DR 1000V SE 17 mm |
| FM-S.19AVSE | Socket, 1/2 DR 1000V SE 19 mm |
| FT-S.151AVSE | Ratchet 1/2 DR 1000V SE 10-3/8" |
| FT-S.210AVSE | Extension 1/2 DR 1000V SE 5-3/4" |
| FT-S.215AVSE | Extension 1/2 DR 1000V SE 10-5/8" |

**FACOM® 1/4" DRIVE INSULATED SOCKETS - 6 POINT**

- › For manual use.
- › For working on live components up to 1000V AC and 1500 DC.



| Product # | Size (mm) | Nut End Outside Dia. (in) (B) | Drive End Outside Dia. (in) (C) | Overall Length (in) (L) | Weight (lbs) |
|--------------------|-----------|----------------------------------|------------------------------------|-------------------------|--------------|
| FM-R.6AVSE | 6 | 5/8 | 55/64 | 55/64 | 0.04 |
| FM-R.7AVSE | 7 | 43/64 | 55/64 | 55/64 | 0.04 |
| FM-R.8AVSE | 8 | 43/64 | 55/64 | 55/64 | 0.04 |
| FM-R.10AVSE | 10 | 45/64 | 55/64 | 55/64 | 0.06 |
| FM-R.12AVSE | 12 | 55/64 | 55/64 | 55/64 | 0.07 |



FACOM® 1/4" DRIVE INSULATED HEX BIT SOCKETS

METRIC

- › For manual use.
- › For working on live components up to 1000V AC and 1500 DC.

| Product # | Size (mm) | Overall Length (in) (L) | Weight (lbs) |
|-------------|-----------|-------------------------|--------------|
| FM-RT.4AVSE | 4 | 1-29/64 | 0.05 |
| FM-RT.5AVSE | 5 | 1-29/64 | 0.06 |
| FM-RT.6AVSE | 6 | 1-29/64 | 0.06 |



FACOM® 3/8" DRIVE METRIC INSULATED SOCKETS - 12 POINT

METRIC

- › For manual use.
- › For working on live components up to 1000V AC and 1500DC.

| Product # | Size (mm) | Nut End Outside Dia. (in) (B) | Drive End Outside Dia. (in) (C) | Overall Length (in) (L) | Weight (lbs) |
|-------------|-----------|-------------------------------|---------------------------------|-------------------------|--------------|
| FM-J.8AVSE | 8 | 43/64 | 45/64 | 1-11/16 | 0.08 |
| FM-J.10AVSE | 10 | 25/32 | 45/64 | 1-11/16 | 0.08 |
| FM-J.11AVSE | 11 | 53/64 | 45/64 | 1-13/16 | 0.08 |
| FM-J.12AVSE | 12 | 55/64 | 45/64 | 1-13/16 | 0.09 |
| FM-J.13AVSE | 13 | 29/32 | 45/64 | 1-13/16 | 0.10 |
| FM-J.14AVSE | 14 | 63/64 | 45/64 | 1-13/16 | 0.10 |
| FM-J.15AVSE | 15 | 63/64 | 45/64 | 1-13/16 | 0.11 |
| FM-J.16AVSE | 16 | 1-1/16 | 45/64 | 1-13/16 | 0.13 |
| FM-J.17AVSE | 17 | 1-1/16 | 45/64 | 1-13/16 | 0.15 |
| FM-J.18AVSE | 18 | 1-9/64 | 45/64 | 1-13/16 | 0.16 |
| FM-J.19AVSE | 19 | 1-7/32 | 45/64 | 1-31/32 | 0.16 |



FACOM® 3/8" DRIVE METRIC DEEP INSULATED SOCKETS - 12 POINT

METRIC

| Product # | Size (mm) | Nut End Outside Dia. (in) (B) | Drive End Outside Dia. (in) (C) | Overall Length (in) (L) | Weight (lbs) |
|--------------|-----------|-------------------------------|---------------------------------|-------------------------|--------------|
| FM-J.8LAVSE | 8 | 3/4 | 45/64 | 2-31/64 | 0.10 |
| FM-J.13LAVSE | 13 | 55/64 | 45/64 | 2-31/64 | 0.17 |
| FM-J.14LAVSE | 14 | 29/32 | 45/64 | 2-23/64 | 0.18 |
| FM-J.16LAVSE | 16 | 29/32 | 45/64 | 2-63/64 | 0.27 |
| FM-J.17LAVSE | 17 | 63/64 | 45/64 | 2-63/64 | 0.33 |
| FM-J.18LAVSE | 18 | 1-1/16 | 45/64 | 2-63/64 | 0.37 |
| FM-J.19LAVSE | 19 | 1-7/64 | 45/64 | 2-63/64 | 0.33 |



FACOM® 3/8" DRIVE INSULATED HEX BIT SOCKETS



- › For manual use.
- › For working on live components up to 1000V AC and 1500 DC.

| Product # | Size (mm) | Nut End Outside Dia. (in) (B) | Drive End Outside Dia. (in) (C) | Overall Length (in) (L) | Weight (lbs) |
|--------------|-----------|-------------------------------|---------------------------------|-------------------------|--------------|
| FM-JT.4AVSE | 4 | 25/64 | 45/64 | 3-5/32 | 0.10 |
| FM-JT.5AVSE | 5 | 25/64 | 45/64 | 2-9/16 | 0.10 |
| FM-JT.6AVSE | 6 | 25/64 | 45/64 | 2-9/16 | 0.10 |
| FM-JT.7AVSE | 7 | 25/64 | 45/64 | 2-9/16 | 0.11 |
| FM-JT.8AVSE | 8 | 25/64 | 45/64 | 2-3/4 | 0.13 |
| FM-JT.10AVSE | 10 | 25/64 | 45/64 | 2-3/4 | 0.13 |



FACOM® 1/2" DRIVE METRIC INSULATED SOCKETS - 12 POINT



| Product # | Size (mm) | Nut End Outside Dia. (in) (B) | Drive End Outside Dia. (in) (C) | Overall Length (in) (L) | Weight (lbs) |
|-------------|-----------|----------------------------------|------------------------------------|-------------------------|--------------|
| FM-S.8AVSE | 8 | 43/64 | 55/64 | 2-5/32 | 0.14 |
| FM-S.9AVSE | 9 | 45/64 | 55/64 | 3-5/32 | 0.15 |
| FM-S.10AVSE | 10 | 3/4 | 55/64 | 2-5/32 | 0.14 |
| FM-S.11AVSE | 11 | 25/32 | 55/64 | 2-5/32 | 0.15 |
| FM-S.12AVSE | 12 | 55/64 | 55/64 | 2-5/32 | 0.15 |
| FM-S.13AVSE | 13 | 29/32 | 55/64 | 2-5/32 | 0.16 |
| FM-S.14AVSE | 14 | 15/16 | 55/64 | 3-5/32 | 0.16 |
| FM-S.17AVSE | 17 | 1-7/64 | 55/64 | 2-5/32 | 0.18 |
| FM-S.19AVSE | 19 | 1-17/64 | 55/64 | 2-5/32 | 0.20 |
| FM-S.21AVSE | 21 | 1-19/64 | 55/64 | 2-5/32 | 0.23 |
| FM-S.22AVSE | 22 | 1-11/32 | 55/64 | 2-5/32 | 0.25 |

FACOM® 1/2" DRIVE METRIC DEEP INSULATED SOCKETS - 12 POINT



| Product # | Size (mm) | Nut End Outside Dia. (in) (B) | Drive End Outside Dia. (in) (C) | Overall Length (in) (L) | Weight (lbs) |
|--------------|-----------|----------------------------------|------------------------------------|----------------------------|--------------|
| FM-S.12LAVSE | 12 | 55/64 | 55/64 | 3-1/32 | 0.39 |
| FM-S.13LAVSE | 13 | 29/32 | 55/64 | 3-1/32 | 0.39 |
| FM-S.14LAVSE | 14 | 15/16 | 55/64 | 3-1/32 | 0.39 |
| FM-S.16LAVSE | 16 | 1-1/16 | 55/64 | 3-1/32 | 0.39 |
| FM-S.17LAVSE | 17 | 1-3/32 | 55/64 | 3-1/32 | 0.39 |
| FM-S.18LAVSE | 18 | 1-5/32 | 55/64 | 3-1/32 | 0.47 |
| FM-S.19LAVSE | 19 | 1-1/4 | 55/64 | 3-1/32 | 0.52 |

FACOM® 1/2" DRIVE INSULATED HEX BIT SOCKETS



| Product # | Size (mm) | Nut End Outside Dia. (in) (B) | Drive End Outside Dia. (in) (C) | Overall Length (in)(L) | Weight (lbs) |
|--------------|-----------|----------------------------------|------------------------------------|------------------------|--------------|
| FM-ST.8AVSE | 8 | 5/16 | 55/64 | 2-3/4 | 0.19 |
| FM-ST.10AVSE | 10 | 25/64 | 55/64 | 2-3/4 | 0.19 |
| FM-ST.12AVSE | 12 | 15/32 | 55/64 | 3-5/8 | 0.31 |
| FM-ST.14AVSE | 14 | 35/64 | 55/64 | 3-5/8 | 0.34 |
| FM-ST.17AVSE | 17 | 43/64 | 55/64 | 3-5/8 | 0.37 |



FACOM® INSULATED BOX WRENCHES - 12 POINT



- › Insulated to 1000V or 1500 DC.
- › 2 color warning handle insulation - color changes from orange to yellow if insulation integrity compromised.
- › 12 point box end allows for fine indexing, helping to improve speed and access.
- › Fits 4, 6, and 12 point fasteners.



| Product # | Size (mm) | Outside Head Width (in) (C) | Head Thickness (in) (D) | Offset Height (in) (E) | Overall Length (in) | Weight (lbs) |
|--------------|-----------|-----------------------------|-------------------------|------------------------|---------------------|--------------|
| FM-55.8AVSE | 8 | 5/8 | 5/16 | 5/8 | 6-1/32 | 0.12 |
| FM-55.9AVSE | 9 | 43/64 | 23/64 | 43/64 | 6-1/2 | 0.13 |
| FM-55.10AVSE | 10 | 3/4 | 23/64 | 43/64 | 6-5/16 | 0.12 |
| FM-55.11AVSE | 11 | 25/32 | 25/64 | 3/4 | 6-11/16 | 0.15 |
| FM-55.12AVSE | 12 | 53/64 | 7/16 | 25/32 | 6-7/8 | 0.23 |
| FM-55.13AVSE | 13 | 29/32 | 15/32 | 25/32 | 7-3/32 | 0.22 |
| FM-55.14AVSE | 14 | 63/64 | 15/32 | 53/64 | 7-15/32 | 0.27 |
| FM-55.15AVSE | 15 | 1-1/32 | 15/32 | 53/64 | 7-11/16 | 0.29 |
| FM-55.16AVSE | 16 | 1-1/16 | 33/64 | 1-1/32 | 8-1/16 | 0.34 |
| FM-55.17AVSE | 17 | 1-3/16 | 35/64 | 1-1/16 | 7-7/8 | 0.34 |
| FM-55.18AVSE | 18 | 1-3/16 | 35/64 | 1-1/16 | 8-7/8 | 0.46 |
| FM-55.19AVSE | 19 | 1-17/64 | 35/64 | 1-1/16 | 9-1/4 | 0.49 |
| FM-55.21AVSE | 21 | 1-3/8 | 5/8 | 1-7/32 | 10-1/32 | 0.75 |

FACOM® INSULATED VSE METRIC OPEN END WRENCHES



- › 2 color warning handle insulation - color changes from orange to yellow if insulation integrity compromised.
- › Specific heat treatment and oiled quenching achieve core hardness without embrittlement or distortion.
- › Size tolerances applied by Facom® exceed standard specifications.



| Product # | Size (mm) | Outside Head Width (in) (C) | Head Thickness (in) (D) | Overall Length (in) | Weight (lbs) |
|--------------|-----------|-----------------------------|-------------------------|---------------------|--------------|
| FM-46.8AVSE | 8 | 55/64 | 7/8 | 4-23/32 | 0.07 |
| FM-46.9AVSE | 9 | 15/16 | 5/16 | 4-29/32 | 0.09 |
| FM-46.10AVSE | 10 | 63/64 | 31/32 | 5-1/8 | 0.11 |
| FM-46.11AVSE | 11 | 1-9/64 | 1-5/32 | 5-5/16 | 0.12 |
| FM-46.12AVSE | 12 | 1-3/16 | 1-3/16 | 5-5/16 | 0.14 |
| FM-46.13AVSE | 13 | 1-17/64 | 1-1/4 | 5-29/32 | 0.17 |
| FM-46.14AVSE | 14 | 1-11/32 | 1-11/32 | 6-5/16 | 0.20 |
| FM-46.15AVSE | 15 | 1-27/64 | 1-13/32 | 6-5/16 | 0.20 |
| FM-46.16AVSE | 16 | 1-1/2 | 1-1/2 | 6-11/16 | 0.26 |
| FM-46.17AVSE | 17 | 1-39/64 | 1-5/8 | 7-3/32 | 0.29 |
| FM-46.18AVSE | 18 | 1-21/32 | 1-21/32 | 7-3/32 | 0.33 |
| FM-46.19AVSE | 19 | 1-49/64 | 1-25/32 | 7-11/16 | 0.34 |
| FM-46.21AVSE | 21 | 1-31/32 | 35/64 | 7-9/32 | 0.40 |

FACOM® INSULATED ADJUSTABLE WRENCHES



- › Finger stops help keep hands safe.
- › 2 color warning handle insulation - color changes from orange to yellow if insulation integrity is compromised.
- › Graduated head, 15° angle.
- › Burnished finish.
- › Thumbwheel rotates counterclockwise.



| Product # | Max Opening (in) | Overall Length (in) | Weight (lbs) |
|----------------|------------------|---------------------|--------------|
| FA-113.8TAVSE | 1-1/16 | 8-15/32 | 0.83 |
| FA-113.10TAVSE | 1-3/16 | 10-7/16 | 1.37 |
| FA-113.12TAVSE | 1-11/32 | 12-19/32 | 1.93 |
| FA-113.15TAVSE | 1-47/64 | 15-9/16 | 3.12 |

FACOM® INSULATED SCREWDRIVERS



- › Designed for working on live components up to 1000V AC and 1500V DC.

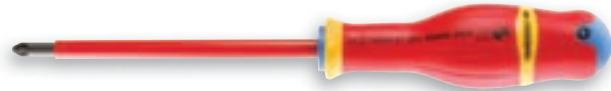

| Product # | Tip Size | Tips | Shank Length (in) (L1) | Shank Type | Overall Length (in) (L) | Weight (lbs) |
|---------------|----------|-----------|------------------------|------------|-------------------------|--------------|
| FW-AD0X75VE | PZ0 | Pozidriv® | 3 | Round | 7 | 0.10 |
| FW-AD1X100VE | PZ1 | Pozidriv® | 4 | Round | 8-1/4 | 0.16 |
| FW-AD3X150VE | PZ3 | Pozidriv® | 6 | Round | 10-53/64 | 0.43 |
| FW-AP0X75VE | 0 | Phillips® | 3 | Round | 7 | 0.10 |
| FW-AP1X100VE | 1 | Phillips® | 4 | Round | 8-1/4 | 0.16 |
| FW-AP2X125VE | 2 | Phillips® | 5 | Round | 9-3/4 | 0.28 |
| FW-AP3X150VE | 3 | Phillips® | 6 | Round | 10-3/4 | 0.43 |
| FW-AP4X200VE | 4 | Phillips® | 8 | Round | 13 | 0.61 |
| FW-A10X200VE | 10 | Cabinet | 7-7/8 | Round | 12-3/4 | 0.61 |
| FW-A12X250VE | 12 | Cabinet | 9-7/8 | Round | 14-3/4 | 0.89 |
| FW-A2.5X50VE | 2.5 mm | Cabinet | 2 | Round | 5-7/8 | 0.06 |
| FW-A2.5X75VE | 2.5 mm | Cabinet | 3 | Round | 6-7/8 | 0.06 |
| FW-A3.5X100VE | 3.5 mm | Cabinet | 4 | Round | 7-7/8 | 0.12 |
| FW-A3.5X75VE | 3.5 mm | Cabinet | 3 | Round | 6-7/8 | 0.11 |
| FW-A3X75VE | 3 mm | Cabinet | 3 | Round | 6-7/8 | 0.10 |
| FW-A4X100VE | 4 mm | Cabinet | 4 | Round | 7-7/8 | 0.16 |
| FW-A4X150VE | 4 mm | Cabinet | 5-7/8 | Round | 9-7/8 | 0.17 |
| FW-A5.5X125VE | 5.5 mm | Cabinet | 5 | Round | 8-7/8 | 0.20 |
| FW-A5.5X150VE | 5.55 mm | Cabinet | 5-7/8 | Round | 10-1/8 | 0.21 |
| FW-A5.5X200VE | 5.5 mm | Cabinet | 7-7/8 | Round | 12-1/2 | 0.21 |
| FW-A6.5X150VE | 6.5 mm | Cabinet | 5-7/8 | Round | 10-1/2 | 0.31 |
| FW-A6.5X200VE | 6.5 mm | Cabinet | 7-7/8 | Round | 12-1/2 | 0.35 |
| FW-A8X150VE | 8 mm | Cabinet | 5-7/8 | Round | 10-1/2 | 0.43 |
| FW-A8X200VE | 8 mm | Cabinet | 7-7/8 | Round | 12-3/4 | 0.48 |



FACOM® 8 PIECE 1000V INSULATED SCREWDRIVER SET



Product #: **FW-MOD.A1VE**

- › Set includes: PZ1, PZ2, 1, 2, 3.5 mm, 4 mm, 5.5 mm, and 6.5 mm sizes.
- › Designed for working on live components up to 1000V AC and 1500V DC.
- › Ergonomically designed, Bi-Material handle.
- › Strong, comfortable grip for high torque action.
- › Carbon silicon steel blade for strength.
- › Black tip to retain the dimensional accuracy of the machined tip.
- › Weight (lbs): 2.34



| Contents | Description | Tip Size | Tips | Shank Length (in) (L1) | Shank Type | Overall Length (in) (L) | Weight (lbs) |
|---------------|--|----------|-----------|------------------------|------------|-------------------------|--------------|
| FW-A3.5X100VE | Screwdriver, Round Bar Slotted 3.5 mm x 4" | 3.5 mm | Cabinet | 4 | Round | 7-7/8 | 0.12 |
| FW-A4X100VE | Screwdriver, Round Bar Slotted 4 mm x 4" | 4 mm | Cabinet | 4 | Round | 7-7/8 | 0.16 |
| FW-A5.5X125VE | Screwdriver, Round Bar Slotted 5.5 mm x 5" | 5.5 mm | Cabinet | 5 | Round | 8-7/8 | 0.20 |
| FW-A6.5X150VE | Screwdriver, Round Bar Slotted 6.5 mm x 5-7/8" | 6.5 mm | Cabinet | 5-7/8 | Round | 10-1/2 | 0.31 |
| FW-AP1X100VE | Screwdriver, Round Bar #1 x 4" | 1 | Phillips® | 4 | Round | 8-1/4 | 0.16 |
| FW-AP2X125VE | Screwdriver, Round Bar #2 x 5" | 2 | Phillips® | 5 | Round | 9-3/4 | 1.50 |
| FW-AD1X100VE | Screwdriver, Pozidriv® Round Bar PZ1 x 4" | PZ1 | Pozidriv® | 4 | Round | 8-1/4 | 0.16 |
| - | Screwdriver, Pozidriv® Round Bar PZ2 x 5" | PZ2 | Pozidriv® | 5 | Round | 9-3/4 | 1.50 |

INSULATED NUT DRIVERS

- › Insulated to 1000V AC or 1500 DC.

| Product # | Size (in) | Length (in) | Weight (lbs) |
|--------------------|------------|-------------|--------------|
| FM-71.1AVSE | 6x8 10x12 | 6 | 0.36 |
| FM-71.2AVSE | 6x9 11x13 | 6 | 0.54 |
| FM-71.3AVSE | 8x10 12x14 | 6 | 0.56 |



INSULATED T-HANDLES

- › Insulated to 1000V AC or 1500 DC.

| Product # | Size (mm) | Length (in) | Weight (lbs) |
|-----------------------|-----------|-------------|--------------|
| FM-94T.6AVSE | 6 | 5-3/4 | 0.33 |
| FM-94T.8AVSE | 8 | 5-3/4 | 0.36 |
| FM-94T.10AVSE | 10 | 5-3/4 | 0.41 |
| FM-94T.11AVSE | 11 | 5-3/4 | 0.47 |
| FM-94T.12AVSE | 12 | 5-3/4 | 0.47 |
| FM-94T.13AVSE | 13 | 5-3/4 | 0.50 |
| FM-94T.14AVSE | 14 | 5-3/4 | 0.50 |
| FM-94TL.10AVSE | 10 | 12-1/2 | 0.91 |
| FM-94TL.13AVSE | 13 | 12-1/2 | 1.15 |
| FM-94TL.16AVSE | 16 | 12-1/2 | 1.85 |
| FM-94TL.17AVSE | 17 | 12-1/2 | 1.92 |
| FM-94TL.19AVSE | 19 | 12-1/2 | 2.06 |



PROTO® SOFT GRIP SLOTTED SCREWDRIVERS

- › Precision tips for tight tolerance and fastener fit.
- › Custom designed handles constructed of dual materials with hard center core for strength with cushion grip for comfort and control.
- › Blades are constructed from high-alloy steel for high-strength and performance. Plated to resist corrosion.
- › Cushion handle tapered for easy gripping and comfort.
- › Flutes designed for better turning.
- › Not insulated against electrical shock.

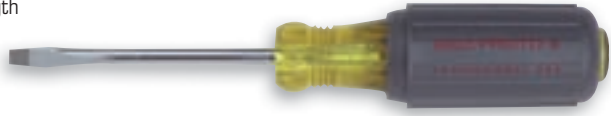

| Product # | Tip Size | Tips | Shank Length (in) (L1) | Shank Type | Overall Length (in) (L) | Weight (lbs) |
|--------------|----------|----------|------------------------|------------|-------------------------|--------------|
| J9406 | 5/16 | Keystone | 6 | Round | 10-13/32 | 0.35 |
| J9408 | 3/8 | Keystone | 8 | Round | 13-1/2 | 0.62 |
| J9403 | 3/16 | Keystone | 3 | Round | 6-3/4 | 0.17 |



ASME B107.600

PROTO® SOFT GRIP PHILLIPS® SCREWDRIVERS

- › Precision machined tips for precise fastener fit.
- › Four-sided handle with broad, shallow flutes for a firm grip and comfort.
- › Non-slip grip increases torque and maximizes comfort.
- › Blasted tips resist chrome peeling.
- › Wear-hardened for precise cross point dimensions and long life.
- › Not insulated against electrical shock.

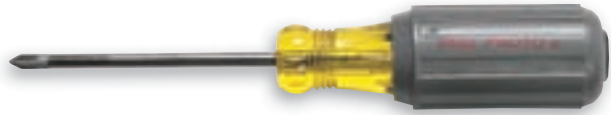

| Product # | Tip Size | Tips | Shank Type | Overall Length (in) (L) | Weight (lbs) |
|--------------|----------|-----------|------------|-------------------------|--------------|
| J9482 | 1 | Phillips® | Round | 6-3/4 | 0.17 |
| J9484 | 2 | Phillips® | Round | 8-11/32 | 0.27 |



6 PIECE FACOM® 1000V VE PLIER/SCREWDRIVER SET**Product #:** FW-184.J5VE

- › Designed for working on live components up to 1000V AC and 1500V DC.

| Contents | Description |
|----------------|--|
| FA-185.20VE | Pliers, Halfround 1000V VE 7-7/8" |
| FA-187.18VE | Pliers, Combo 1000V VE 7-1/4" |
| FA-192.16VE | Pliers, Diagonal Cutting 1000V VE 6-1/4" |
| FW-ADY.1X100VE | Screwdriver, 1000V Pozidriv® |
| FW-AY.4X100VE | Screwdriver, 1000V 4 mm Slotted 7-7/8" |
| FW-AY.5.5X125V | Screwdriver, 1000V 5.5 mm Slotted 8-7/8" |

**FACOM® 3 PIECE VE PLIERS SET****Product #:** FW-MOD.VE

- › 1000V insulated grips designed for electrical safety when working on or near live components.
- › Handles designed to resist workshop chemicals (Skydrol®, chlorothene, acetone, petrol).

| Contents | Description |
|-------------|--|
| FA-180.VE | Pliers, Multigrip 1000V VE 10" |
| FA-194.17VE | Pliers, Wire Stripper 1000V VE 6-1/2" |
| FA-391.16VE | Pliers, Diagonal Cutting 1000V VE 6-1/2" |

**FACOM® INSULATED VE MUTIGRIP PLIERS**

- › 1000V insulated grips designed for electrical safety when working on or near live components.

| Product # | Overall Size (in) | Length (in) (L) | Jaw Length (in) (A) | Jaw Width (in) (B) | Weight (lbs) |
|-----------|-------------------|-----------------|---------------------|--------------------|--------------|
| | | | | | |
| FA-180.VE | 10 | 10 | 1-3/16 | 7/8 | 0.78 |

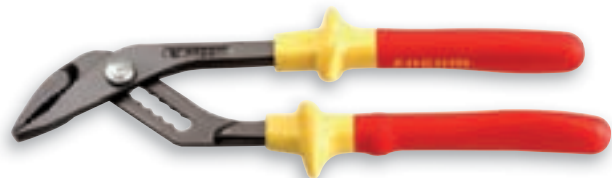
**FACOM® INSULATED VE HALF ROUND PLIERS**

- › 1000V insulated grips designed for electrical safety when working on or near live components.
- › Side cutter for steel wire up to 14AWG.
- › Serrated jaws with central area for handling rods.

| Product # | Size (in) | Overall Length (in) (L) | Jaw Length (in) (A) | Jaw Width (in) (B) | Weight (lbs) |
|-------------|-----------|-------------------------|---------------------|--------------------|--------------|
| FA-185.20VE | 7-7/8 | 7-7/8 | 2-15/16 | 11/32 | 0.45 |
| FA-193.16VE | 6-1/2 | 6-7/8 | 1-13/16 | 11/32 | 0.41 |



FACOM® INSULATED VE COMBINATION PLIERS



- › 1000V insulated grips designed for electrical safety when working on or near live components.
- › High-frequency hardened cutting edges for power and durability.
- › Nose profile combines strength and maneuverability.



| Product # | Size (in) | Overall Length (in) (L) | Jaw Length (in) (A) | Jaw Width (in) (B) | Weight (lbs) |
|-------------|-----------|-------------------------|---------------------|--------------------|--------------|
| FA-187.16VE | 6-1/2 | 6-1/2 | 1-11/32 | 3/8 | 0.43 |
| FA-187.18VE | 7-1/4 | 7-9/32 | 1-13/32 | 13/32 | 0.53 |

FACOM® INSULATED VE FLAT NOSE PLIERS



- › 1000V insulated grips designed for electrical safety when working on or near live components.
- › Serrated jaws for firm grip.
- › Nose designed for confined spaces.



| Product # | Size (in) | Overall Length (in) (L) | Jaw Length (in) (A) | Jaw Width (in) (B) | Weight (lbs) |
|-------------|-----------|-------------------------|---------------------|--------------------|--------------|
| FA-188.16VE | 6-1/2 | 6-11/16 | 1-13/16 | 11/32 | 0.38 |
| FA-188.20VE | 7-7/8 | 8-1/16 | 2-15/16 | 11/32 | 0.42 |

FACOM® INSULATED VE ROUND NOSE PLIERS



- › 1000V insulated grips designed for electrical safety when working on or near live components.
- › For shaping loops, bends or rings.
- › Serrated jaws.



| Product # | Size (in) | Overall Length (in) (L) | Jaw Length (in) (A) | Jaw Width (in) (B) | Weight (lbs) |
|-------------|-----------|-------------------------|---------------------|--------------------|--------------|
| FA-189.17VE | 6-1/2 | 6-7/8 | 1-13/16 | 11/32 | 0.37 |

FACOM® INSULATED WIRE STRIPPER PLIERS



- › 1000V insulated grips designed for electrical safety when working on or near live components.
- › Jaws angled at 40°.
- › Cuts single and multi-cone wire up to 14 AWG.
- › Serrated jaws with central area for handling rods.



| Product # | Size (in) | Overall Length (in) (L) | Jaw Length (in) (A) | Jaw Width (in) (B) | Weight (lbs) |
|-------------|-----------|-------------------------|---------------------|--------------------|--------------|
| FA-194.17VE | 6-1/2 | 7-11/16 | 1 | 5/8 | 0.38 |



FACOM® INSULATED VE BENT NOSE PLIERS



- › 1000V insulated grips designed for electrical safety when working on or near live components.
- › Jaws angled at 40°.
- › Cuts single and multi-cone wire up to 14 AWG.
- › Serrated jaws with central area for handling rods.



| Product # | Size (in) | Overall Length (in) (L) | Jaw Length (in) (A) | Jaw Width (in) (B) | Weight (lbs) |
|--------------------|-----------|-------------------------|---------------------|--------------------|--------------|
| FA-195.16VE | 6-3/8 | 6-7/8 | 1-5/8 | 11/32 | 0.39 |
| FA-195.20VE | 7-7/8 | 7-15/32 | 2-3/4 | 11/32 | 0.43 |

FACOM® INSULATED VE END CUTTER PLIERS



- › 1000V insulated grips designed for electrical safety when working on or near live components.
- › High-frequency hardened cutting edges ensure durable cut quality for hard wire up to 12 AWG.
- › Offset pivot to help reduce manual cutting efforts required with a center pivot point.



| Product # | Size (in) | Overall Length (in) (L) | Jaw Length (in) (A) | Jaw Width (in) (B) | Weight (lbs) |
|--------------------|-----------|-------------------------|---------------------|--------------------|--------------|
| FA-190.16VE | 6-1/2 | 6-1/2 | 1/4 | 7/16 | 0.51 |

FACOM® INSULATED VE DIAGONAL PLIERS



- › 1000V insulated grips designed for electrical safety when working on or near live components.
- › High-frequency hardened cutting edges ensure durable cut quality for hard wire up to 200kg/mm.
- › Offset pivot for reduced cutting effort.



| Product # | Size (in) | Overall Length (in) (L) | Jaw Length (in) (A) | Jaw Width (in) (B) | Weight (lbs) |
|--------------------|-----------|-------------------------|---------------------|--------------------|--------------|
| FA-192.14VE | 5-3/4 | 5-23/32 | 5/8 | 3/8 | 0.36 |
| FA-192.16VE | 6-1/4 | 6-7/8 | 23/32 | 13/32 | 0.46 |
| FA-192.18VE | 7-1/8 | 7-15/32 | 25/32 | 7/16 | 0.57 |

FACOM® INSULATED VE DIAGONAL CUTTERS



- › 1000V insulated grips designed for electrical safety when working on or near live components.
- › Edges designed for clean cut in copper wire.
- › High-frequency hardened cutting edges for durable cut accuracy.
- › Snipe nose for maneuverability in control cabinets or cutting cable loom ties.



| Product # | Size (in) | Overall Length (in) (L) | Jaw Length (in) (A) | Jaw Width (in) (B) | Weight (lbs) |
|--------------------|-----------|-------------------------|---------------------|--------------------|--------------|
| FA-391.16VE | 6-1/2 | 6-11/16 | 3/4 | 13/32 | 0.46 |

FACOM® INSULATED HEX KEYS

- › Hardened alloy-steel exceeds specified strengths.
- › 2-color warning insulation.
- › Insulated to 1000V AC or 1500 DC.



| Product # | Size (mm) | Long Arm Length (in) | Short Arm Length (in) | Weight (lbs) |
|---------------------|-----------|----------------------|-----------------------|--------------|
| FM-83.3AVSE | 3 | 4-59/64 | 3-11/32 | 0.04 |
| FM-83.4AVSE | 4 | 4-59/64 | 3-11/32 | 0.07 |
| FM-83.5AVSE | 5 | 4-59/64 | 3-11/32 | 0.11 |
| FM-83.6AVSE | 6 | 4-59/64 | 3-11/32 | 0.15 |
| FM-83.8AVSE | 8 | 4-59/64 | 3-11/32 | 0.24 |
| FM-83.10AVSE | 10 | 4-59/64 | 3-11/32 | 0.33 |
| FM-83.12AVSE | 12 | 4-59/64 | 3-11/32 | 0.46 |

FACOM® INSULATED VSE MULTIGRIP PLIERS

- › 1000V insulated grips designed for electrical safety when working on or near live components.
- › 2 color warning handle insulation - color changes from orange to yellow if insulation integrity compromised.



| Product # | Size (in) | Overall Length (in) (L) | Jaw Length (in) (A) | Jaw Width (in) (B) | Weight (lbs) |
|-------------------|-----------|-------------------------|---------------------|--------------------|--------------|
| FA-180.VSE | 10 | 10-1/32 | 1-9/16 | 1-3/8 | 0.81 |

FACOM® INSULATED VSE HALF ROUND PLIERS

- › 2 Color warning handle insulation - color changes from orange to yellow if insulation integrity compromised.
- › Insulated to 1000V AC or 1500 DC.
- › Integrated wire-cutter.
- › Burnished nose.



| Product # | Size (in) | Overall Length (in) (L) | Jaw Length (in) (A) | Jaw Width (in) (B) | Weight (lbs) |
|----------------------|-----------|-------------------------|---------------------|--------------------|--------------|
| FA-185.20AVSE | 7-7/8 | 8-9/32 | 2-23/32 | 1-3/8 | 0.53 |
| FA-193.16AVSE | 6-1/2 | 6-7/8 | 1-31/32 | 1-1/4 | 0.37 |

FACOM® INSULATED VSE COMBINATION PLIERS

- › 2 color warning handle insulation - color changes from orange to yellow if insulation integrity compromised.
- › Insulated to 1000V AC or 1500 DC.
- › Hardened throughout for overall strength.
- › Cutting edges locally heat-treated to exceed 60 HRC hardness.
- › Burnished nose.
- › Serrated Jaw.



| Product # | Size (in) | Overall Length (in) (L) | Jaw Length (in) (A) | Jaw Width (in) (B) | Weight (lbs) |
|----------------------|-----------|-------------------------|---------------------|--------------------|--------------|
| FA-187.16AVSE | 6-1/2 | 6-1/2 | 1-11/32 | 1-3/8 | 0.44 |
| FA-187.18AVSE | 7-1/4 | 7-3/32 | 1-3/8 | 1-3/8 | 0.54 |
| FA-187.20AVSE | 8 | 7-9/32 | 1-43/64 | 1-3/8 | 0.69 |

FACOM® INSULATED VSE FLAT NOSE PLIERS

- › 2 color warning handle insulation - color changes from orange to yellow if insulation integrity compromised.
- › Insulated to 1000V AC or 1500 DC.
- › Serrated jaws for firm grip.
- › Burnished nose.



| Product # | Size (in) | Overall Length (in) (L) | Jaw Length (in) (A) | Jaw Width (in) (B) | Weight (lbs) |
|----------------------|-----------|-------------------------|---------------------|--------------------|--------------|
| FA-188.16AVSE | 6-1/2 | 6-11/16 | 1-31/32 | 1-15/32 | 0.37 |

FACOM® INSULATED VSE ROUND NOSE PLIERS

- › 2 color warning handle insulation - color changes from orange to yellow if insulation integrity compromised.
- › Insulated to 1000V AC or 1500 DC.
- › Long nipe nose, serrated for shaping bends or terminals on all types of wire.
- › Burnished nose.



| Product # | Size (in) | Overall Length (in) (L) | Jaw Length (in) (A) | Jaw Width (in) (B) | Weight (lbs) |
|----------------------|-----------|-------------------------|---------------------|--------------------|--------------|
| FA-189.17AVSE | 6-1/2 | 6-7/8 | 1-25/32 | 1-5/16 | 0.36 |

FACOM® INSULATED VSE WIRE STRIPPER

- › 2 color warning handle insulation - color changes from orange to yellow if insulation integrity compromised.
- › Strips any wire in all common electrical systems, up to 10 AWG.
- › Burnished nose.
- › Knob for presetting the cutting depth.



| Product # | Size (in) | Overall Length (in) (L) | Jaw Length (in) (A) | Jaw Width (in) (B) | Weight (lbs) |
|----------------------|-----------|-------------------------|---------------------|--------------------|--------------|
| FA-194.17AVSE | 6-1/2 | 6-7/8 | 7/8 | 5/16 | 0.45 |

FACOM® INSULATED VSE BENT NOSE PLIERS

- › 1000V insulated grips designed for electrical safety when working on or near live components.
- › Integral wire-cutter.
- › 2 color warning handle insulation - color changes from orange to yellow if insulation integrity compromised.
- › Burnished nose.



| Product # | Size (in) | Overall Length (in) (L) | Jaw Length (in) (A) | Jaw Width (in) (B) | Weight (lbs) |
|----------------------|-----------|-------------------------|---------------------|--------------------|--------------|
| FA-195.20AVSE | 7-7/8 | 7-15/32 | 2-17/32 | 1-1/4 | 0.43 |

FACOM® INSULATED VSE CABLE CUTTERS



- › 2 color warning handle insulation - color changes from orange to yellow if insulation integrity compromised.
- › High performance compact tool.
- › Forged safety stops.
- › Burnished nose.



| Product # | Size (in) | Overall Length (in) (L) | Jaw Length (in) (A) | Jaw Width (in) (B) | Weight (lbs) |
|----------------|-----------|-------------------------|---------------------|--------------------|--------------|
| FA-412.10AVSE | 7-1/2 | 7-7/8 | 3-1/3 | 1-3/8 | 0.91 |
| FA-412.14AVSE | 9 | 9 | 1-3/16 | 1-3/8 | 1.12 |
| FA-412.150AVSE | 17-3/4 | 18-1/2 | 2-23/64 | 1-3/4 | 4.71 |

FACOM® INSULATED VSE RATCHETING CABLE CUTTERS



- › One-hand operation.
- › No cable core distortion.
- › Forged and hardened steel blade.
- › 2 color warning handle insulation - color changes from orange to yellow if insulation integrity compromised.



| Product # | Size (in) | Overall Length (in) (L) | Jaw Width (in) (B) | Weight (lbs) |
|---------------|-----------|-------------------------|--------------------|--------------|
| FA-414.45AVSE | 1-3/4 | 12 | 5-5/16 | 2.19 |
| FA-414.52AVSE | 2 | 13-3/16 | 5-1/2 | 2.26 |

FACOM® INSULATED VSE END CUTTER PLIERS



- › 2 color warning handle insulation - color changes from orange to yellow if insulation integrity compromised.
- › Cutting edges heat-treated to exceed 60 HRc.
- › Burnished nose.



| Product # | Size (in) | Overall Length (in) (L) | Jaw Length (in) (A) | Jaw Width (in) (B) | Weight (lbs) |
|---------------|-----------|-------------------------|---------------------|--------------------|--------------|
| FA-190.16AVSE | 6-1/2 | 6-11/16 | 1/4 | 1-3/8 | 0.56 |

FACOM® INSULATED VSE DIAGONAL PLIERS



- › 2 color warning handle insulation - color changes from orange to yellow if insulation integrity compromised.
- › Cutting edges heat-treated to exceed 60 HRc.
- › Burnished nose.



| Product # | Size (in) | Overall Length (in) (L) | Jaw Length (in) (A) | Jaw Width (in) (B) | Weight (lbs) |
|---------------|-----------|-------------------------|---------------------|--------------------|--------------|
| FA-192.14AVSE | 5-3/4 | 6-3/32 | 5/8 | 1-3/16 | 0.48 |
| FA-192.16AVSE | 6-1/2 | 6-1/2 | 23/32 | 13/32 | 0.54 |
| FA-192.18AVSE | 7-1/4 | 7-9/32 | 25/32 | 7/16 | 0.60 |



FACOM® INSULATED VSE DIAGONAL CUTTERS



- › 2 color warning handle insulation - color changes from orange to yellow if insulation integrity compromised.
- › Inset joint.
- › Burnished nose.



| Product # | Size (in) | Overall Length (in) (L) | Jaw Length (in) (A) | Jaw Width (in) (B) | Weight (lbs) |
|----------------------|-----------|-------------------------|---------------------|--------------------|--------------|
| FA-391.16AVSE | 6-1/2 | 6-5/16 | 3/4 | 13/32 | 0.47 |

WIRE STRIPPER - CRIMPER

- › Strips 10-22 AWG (American Wire Gauge).
- › Box style crimp.
- › Crimps insulated and non-insulated terminals for 10-22 AWG.
- › Crimps non-insulated 7 mm and 8 mm auto ignition wire.
- › Cuts screw/bolt sizes 4-40, 5-40, 6-32, 8-32, 10-32, 10-24.
- › Anvil type wire cutter for cutting copper wire.
- › Air-pocket cushion grips for comfort.

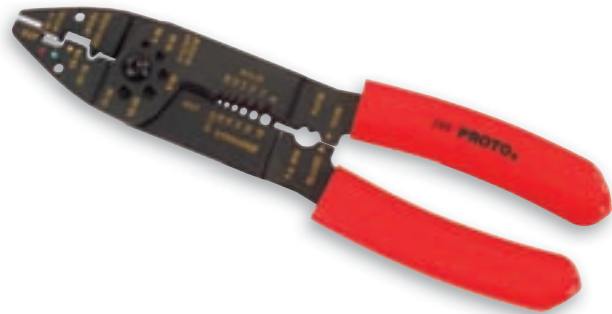

| Product # | Overall Length (in) (L) | Weight (lbs) |
|-------------|-------------------------|--------------|
| J299 | 8-1/2 | 0.45 |



WIRE STRIPPER - CUTTER

- › Strips wire sizes 10, 12, 14, 16, 18, and 20 AWG (American Wire Gauge).
- › Wire cutter for copper wire.
- › Plier nose for pulling and looping wire.
- › Spring return and convenient handle lock.
- › Platisol grips for added comfort.



| Product # | Overall Length (in) (L) | Weight (lbs) |
|-------------|-------------------------|--------------|
| J297 | 6-1/16 | 0.21 |



WIRE STRIPPER

- › Strips wire sizes 22, 24, 26, 28, and 30 AWG (American Wire Gauge).
- › Wire cutter.
- › Plier nose for pulling and looping wire.
- › Automatic spring return.
- › Platisol grips for added comfort.



| Product # | Overall Length (in) (L) | Weight (lbs) |
|-------------|-------------------------|--------------|
| J296 | 6-1/16 | 0.21 |



CABLE CUTTER

- › Cuts up to 3/0 fine stranded copper battery cable (not for use on steel cable).
- › Precision ground blades minimize deflection.
- › Positive fastener maintains pressure on matching cutting surfaces.
- › Plastisol grips for added comfort.

| Product # | Overall Length (in) (L) | Weight (lbs) |
|-------------|-------------------------|--------------|
| J288 | 7-1/2 | 0.56 |



NEEDLE-NOSE PLIERS

- › Diamond serrated jaws.
- › Plastisol grips for added comfort.

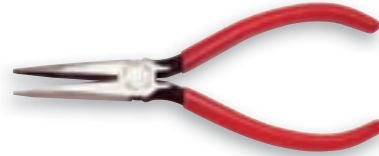

| Product # | Overall Length (in) (L) | Jaw Length (in) (A) | Jaw Width (in) (B) | Jaw Thickness (in) (C) | Weight (lbs) |
|-----------------|-------------------------|---------------------|--------------------|------------------------|--------------|
| J282G | 4-7/8 | 1-3/16 | 7/16 | 1/4 | 0.16 |
| J229-03G | 5-9/16 | 1-11/16 | 1/2 | 9/32 | 0.23 |
| J220G | 6-5/8 | 1-7/8 | 11/16 | 3/8 | 0.35 |



ASME B107.500

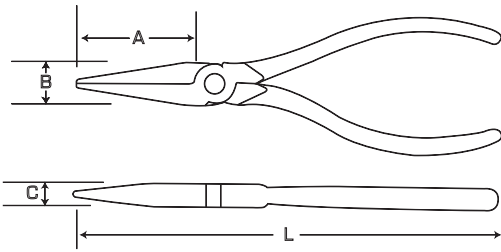

NEEDLE-NOSE PLIERS - COIL SPRING

- › Coil spring.
- › Diamond serrated jaws.
- › Plastisol grips for added comfort.



| Product # | Overall Length (in) (L) | Jaw Length (in) (A) | Jaw Width (in) (B) | Jaw Thickness (in) (C) | Weight (lbs) |
|----------------|-------------------------|---------------------|--------------------|------------------------|--------------|
| J282BSG | 5 | 1-3/16 | 7/16 | 1/4 | 0.16 |



ASME B107.500

NEEDLE-NOSE PLIERS WITH CUTTER

- › Induction hardened cutting edges.
- › Diamond serrated jaws.
- › Plastisol grips for added comfort.

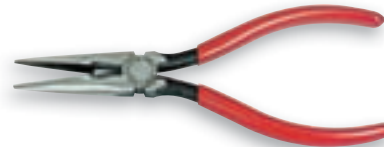

| Product # | Overall Length (in) (L) | Jaw Length (in) (A) | Jaw Width (in) (B) | Jaw Thickness (in) (C) | Weight (lbs) |
|--------------|-------------------------|---------------------|--------------------|------------------------|--------------|
| J226G | 6-5/8 | 1-7/8 | 11/16 | 3/8 | 0.34 |



ASME B107.500



NEEDLE-NOSE PLIERS WITH CUTTER - COIL SPRING

- › Induction hardened cutting edges.
- › Diamond serrated jaws.
- › Coil spring.
- › Plastisol grips for added comfort.

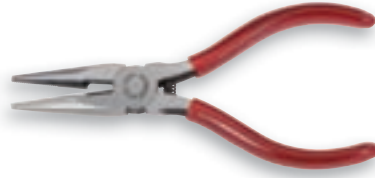

| Product # | Overall Length (in) (L) | Jaw Length (in) (A) | Jaw Width (in) (B) | Jaw Thickness (in) (C) | Weight (lbs) |
|-----------------|-------------------------|---------------------|--------------------|------------------------|--------------|
| J229-016 | 5-9/16 | 1-11/16 | 1/2 | 9/32 | 0.23 |
| J226-016 | 7-1/2 | 2-5/8 | 3/4 | 3/8 | 0.40 |



ASME B107.500

NEEDLE-NOSE PLIERS - LONG REACH

- › Extra-long handle allows greater access to confined, restricted areas.
- › Improved fulcrum point provides more holding power at the tip with less gripping effort.
- › Plastisol grips for added comfort.



| Product # | Overall Length (in) (L) | Jaw Length (in) (A) | Jaw Width (in) (B) | Jaw Thickness (in) (C) | Weight (lbs) |
|--------------|-------------------------|---------------------|--------------------|------------------------|--------------|
| J2406 | 11-9/16 | 2-13/16 | 23/32 | 13/32 | 0.63 |



NEEDLE-NOSE PLIERS - LONG

- › Long handle for added leverage.
- › Diamond serrated jaws.
- › Plastisol grips for added comfort.



| Product # | Overall Length (in) (L) | Jaw Length (in) (A) | Jaw Width (in) (B) | Jaw Thickness (in) (C) | Weight (lbs) |
|--------------|-------------------------|---------------------|--------------------|------------------------|--------------|
| J2286 | 7-25/32 | 1-9/16 | 17/32 | 7/16 | 0.38 |



ASME B107.500

NEEDLE-NOSE PLIERS - LONG THIN

- › Very thin nose allows access into minimum clearance areas.
- › Diamond serrated jaws.
- › Plastisol grips for added comfort.

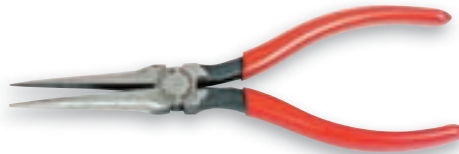

| Product # | Overall Length (in) (L) | Jaw Length (in) (A) | Jaw Width (in) (B) | Jaw Thickness (in) (C) | Weight (lbs) |
|--------------|-------------------------|---------------------|--------------------|------------------------|--------------|
| J2226 | 6-1/16 | 2-1/8 | 11/16 | 11/32 | 0.28 |



ASME B107.500

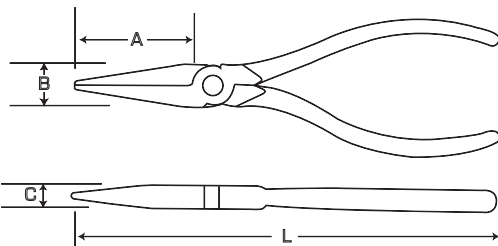

NEEDLE-NOSE PLIERS - LONG EXTRA THIN

- › Extra slim-nose pliers for light precision work.
- › Designed for gripping, looping, and twisting wire in confined areas.
- › Plastisol grips for added comfort.



| Product # | Overall Length (in) (L) | Jaw Length (in) (A) | Jaw Width (in) (B) | Jaw Thickness (in) (C) | Weight (lbs) |
|--------------|-------------------------|---------------------|--------------------|------------------------|--------------|
| J2236 | 6-5/32 | 2-5/32 | 1/2 | 9/32 | 0.20 |

ASME B107.500

BENT NOSE NEEDLE-NOSE PLIERS

- › Nose bent to 78° angle to reach around obstructions.
- › Very thin nose allows access into minimum clearance areas.
- › Diamond serrated jaws.
- › Plastisol grips for added comfort.

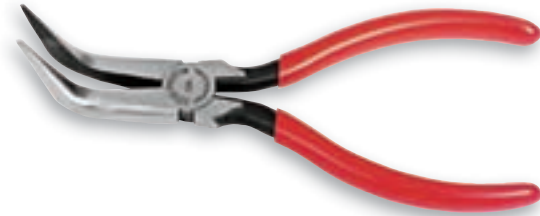

| Product # | Overall Length (in) (L) | Jaw Length (in) (A) | Jaw Width (in) (B) | Jaw Thickness (in) (C) | Weight (lbs) |
|--------------|-------------------------|---------------------|--------------------|------------------------|--------------|
| J2256 | 6-5/16 | 1-5/8 | 3/4 | 3/8 | 0.42 |

ASME B107.500

BENT NOSE NEEDLE-NOSE PLIERS - LONG REACH

- › Extra-long handle allows greater access to confined, restricted areas.
- › Improved fulcrum point provides more holding power at the tip with less gripping effort.
- › Bent nose design to reach around obstructions.
- › Plastisol grips for added comfort.

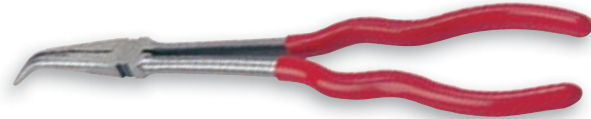

| Product # | Overall Length (in) (L) | Jaw Length (in) (A) | Jaw Width (in) (B) | Jaw Thickness (in) (C) | Weight (lbs) |
|--------------|-------------------------|---------------------|--------------------|------------------------|--------------|
| J2416 | 11-3/8 | 2-9/16 | 23/32 | 13/32 | 0.62 |

ASME B107.500

DUCKBILL PLIERS

- › Wide, flat nose for better grip than standard needle-nose pliers.
- › Diamond serrated jaws.
- › Long handle for added leverage.
- › Plastisol grips for added comfort.



| Product # | Overall Length (in) (L) | Jaw Length (in) (A) | Jaw Width (in) (B) | Jaw Thickness (in) (C) | Weight (lbs) |
|--------------|-------------------------|---------------------|--------------------|------------------------|--------------|
| J2276 | 7-25/32 | 1-9/16 | 17/32 | 7/16 | 0.38 |

ASME B107.500



WIRE STRIPPERS - PLIERS

- › Strips 10-22 AWG (American Wire Gauge).
- › Crimps insulated and non-insulated terminals for 10-22 AWG wire.
- › Crimps non-insulated 7mm and 8mm auto ignition wire.
- › Cuts screw/bolt sizes 4-40, 5-40, 6-32, 8-32, 10-32, 10-24 and copper wire.
- › Extended length curved cutter to handle heavier wire with less force.
- › Plier nose designed to grip, bend, and pull wire.
- › Plastisol grips for added comfort.

| Product # | Overall Length (in) (L) | Weight (lbs) |
|-------------|-------------------------|--------------|
| J298 | 8-1/4 | 0.05 |



DIAGONAL CUTTING PLIERS

- › Induction hardened cutting edges.
- › Thin narrow jaws for access in tight areas.
- › Plastisol grips for added comfort.



| Product # | Overall Length (in) (L) | Jaw Length (in) (A) | Jaw Width (in) (B) | Jaw Thickness (in) (C) | Weight (lbs) |
|--------------|-------------------------|---------------------|--------------------|------------------------|--------------|
| J285G | 4-5/8 | 13/32 | 7/16 | 1/4 | 0.13 |
| J204G | 4-7/16 | 18/32 | 9/16 | 5/16 | 0.22 |
| J205G | 5-1/16 | 3/4 | 19/32 | 3/8 | 0.24 |
| J206G | 6-1/16 | 13/16 | 3/4 | 7/16 | 0.40 |
| J207G | 7-5/16 | 1 | 7/8 | 15/32 | 0.50 |



ASME B107.500

DIAGONAL CUTTING PLIERS - COIL SPRING

- › Coil springs.
- › Induction hardened cutting edges.
- › Thin narrow jaws for access in tight areas.
- › Plastisol grips for added comfort.



| Product # | Overall Length (in) (L) | Jaw Length (in) (A) | Jaw Width (in) (B) | Jaw Thickness (in) (C) | Weight (lbs) |
|----------------|-------------------------|---------------------|--------------------|------------------------|--------------|
| J285BSG | 4-5/8 | 13/32 | 7/16 | 1/4 | 0.13 |
| J204SG | 4-7/16 | 18/32 | 9/16 | 5/16 | 0.22 |



ASME B107.500

DIAGONAL CUTTING PLIERS - ANGLED HEAD

- › Angled head for work in confined areas.
- › Plastisol grips for added comfort.



| Product # | Overall Length (in) (L) | Jaw Length (in) (A) | Jaw Width (in) (B) | Jaw Thickness (in) (C) | Weight (lbs) |
|----------------|-------------------------|---------------------|--------------------|------------------------|--------------|
| J210AHG | 8-1/8 | 3/4 | 1-7/32 | 5/32 | 0.64 |



HEAVY-DUTY DIAGONAL CUTTING PLIERS

- › Induction hardened cutting edge.
- › Powerful leverage cuts heavy wire with ease.
- › Plastisol grips for added comfort.



| Product # | Overall Length (in) (L) | Jaw Length (in) (A) | Jaw Width (in) (B) | Jaw Thickness (in) (C) | Weight (lbs) |
|--------------|-------------------------|---------------------|--------------------|------------------------|--------------|
| J209G | 7-5/16 | 2-5/32 | 7/8 | 1/2 | 0.58 |
| J210G | 8-1/2 | 3/4 | 1-7/32 | 15/32 | 0.64 |



ASME B107.500

DIAGONAL PLASTIC CUTTING PLIERS

- › Adjusting set screw allows fast, precise cutting and prevents cutting edges from damaging each other.
- › Coil spring for reduced hand fatigue.
- › Induction hardened cutting edges.
- › Plastisol grips for added comfort.



| Product # | Overall Length (in) (L) | Jaw Length (in) (A) | Jaw Width (in) (B) | Jaw Thickness (in) (C) | Weight (lbs) |
|--------------|-------------------------|---------------------|--------------------|------------------------|--------------|
| J212G | 6-1/16 | 3/4 | 3/4 | 7/16 | 0.39 |
| J213G | 7-5/16 | 1 | 29/32 | 1/2 | 0.53 |



HIGH LEVERAGE DIAGONAL CUTTING PLIERS LONG REACH - ANGLED HEAD

- › Extra-long handle provides high leverage cutting capabilities with less user effort.
- › 30° angled head for hard-to-reach areas.
- › Wide handle contour for less fatigue.
- › Plastisol grips for added comfort.



| Product # | Overall Length (in) (L) | Jaw Length (in) (A) | Jaw Width (in) (B) | Jaw Thickness (in) (C) | Weight (lbs) |
|--------------|-------------------------|---------------------|--------------------|------------------------|--------------|
| J244G | 11-1/8 | 1 | 63/64 | 1-5/32 | 0.94 |



DIAGONAL CUTTING PLIERS LONG REACH - GRIPPING TIP

- › Cutting and gripping capabilities in one tool.
- › Serrated gripping surface at tips.
- › Plastisol grips for added comfort.



| Product # | Overall Length (in) (L) | Jaw Length (in) (A) | Jaw Width (in) (B) | Jaw Thickness (in) (C) | Weight (lbs) |
|--------------|-------------------------|---------------------|--------------------|------------------------|--------------|
| J2466 | 11-1/8 | 27/32 | 63/64 | 25/64 | 0.74 |



LINEMAN'S PLIERS

- › For utility linemen, wiring and electrical equipment installation, and maintenance.
- › Induction hardened cutting edges and diamond serrated jaws.
- › Built-in insulation crusher
- › Plastisol grips for added comfort.



| Product # | Overall Length (in) (L) | Jaw Length (in) (A) | Jaw Width (in) (B) | Jaw Thickness (in) (C) | Weight (lbs) |
|--------------|-------------------------|---------------------|--------------------|------------------------|--------------|
| J2686 | 8-5/8 | 1-1/2 | 1-3/16 | 5/8 | 0.98 |



ASME B107.500

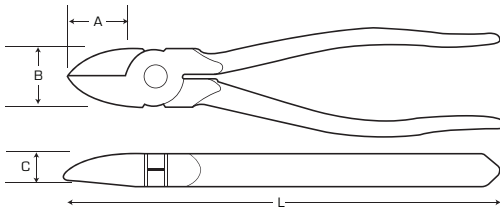

LINEMAN'S PLIERS - NEW ENGLAND STYLE

- › Slim rounded nose for easy access in restricted spaces.
- › Diamond serrated jaws.
- › Plastisol grips for added comfort.



| Product # | Overall Length (in) (L) | Jaw Length (in) (A) | Jaw Width (in) (B) | Jaw Thickness (in) (C) | Weight (lbs) |
|--------------|-------------------------|---------------------|--------------------|------------------------|--------------|
| J266G | 6-3/16 | 1-3/32 | 29/32 | 1/2 | 0.50 |
| J267G | 7-1/4 | 1-9/32 | 1-1/8 | 1/2 | 0.67 |



ASME B107.500

LINEMAN'S PLIERS - HIGH LEVERAGE

- › Jaws have offset rivet for increased leverage.
- › Designed for cutting No. 8 and other large wires.
- › Diamond serrated jaws.
- › Plastisol grips for added comfort.



| Product # | Overall Length (in) (L) | Jaw Length (in) (A) | Jaw Width (in) (B) | Jaw Thickness (in) (C) | Weight (lbs) |
|--------------|-------------------------|---------------------|--------------------|------------------------|--------------|
| J269G | 9-1/4 | 1-3/16 | 1-3/32 | 5/8 | 1.10 |



ASME B107.500

LINEMAN'S PLIERS - PIPE JAW

- › Serrated flat nose jaws with toothed pipe grip.
- › Plastisol grips for added comfort.



| Product # | Overall Length (in) (L) | Jaw Length (in) (A) | Jaw Width (in) (B) | Jaw Thickness (in) (C) | Weight (lbs) |
|----------------|-------------------------|---------------------|--------------------|------------------------|--------------|
| J268PJG | 8-3/8 | 1-3/4 | 1-1/16 | 17/32 | 0.87 |



FACOM® VSE SERIES INSULATED KNIFE



- › For working on live components up to 1000V AC and 1500V DC.
- › Thick, angled blade with flat tip.
- › Cushion handle.
- › Blade sheath.
- › Effective blade length 2".



| Product # | Blade Length (in) | Overall Length (in) | Weight (lbs) |
|---------------------|-------------------|---------------------|--------------|
| FT-1820.AVSE | 2-3/8 | 7-1/2 | 0.19 |

FACOM® VSE SERIES INSULATED HACKSAW



- › Two blade positions.
- › Butterfly tension nut.
- › Supplied with bi-metal blade.
- › 12" blade replacement.



| Product # | Blade Length (in) | Overall Length (in) | Weight (lbs) |
|--------------------|-------------------|---------------------|--------------|
| FT-602.AVSE | 12 | 18-1/2 | 1.30 |

ELECTRICIAN'S KNIFE WITH STRIPPING BLADE

- › Spear blade.
- › Stripping blade.
- › Self-locking combination screwdriver, insulation cutter and wire scraper blade.



| Product # | Blade Length (in) | Closed Position Length (in) | Open Position Length (in) | Weight (lbs) |
|---------------|-------------------|-----------------------------|---------------------------|--------------|
| J18535 | 3 | 3-3/4 | 7 | 0.32 |



ELECTRICIAN'S KNIFE

- › Spear blade.
- › Self-locking combination screwdriver, insulation cutter and wire scraper blade.



| Product # | Blade Length (in) | Closed Position Length (in) | Open Position Length (in) | Weight (lbs) |
|---------------|-------------------|-----------------------------|---------------------------|--------------|
| J18500 | 3 | 3-3/4 | 7 | 0.24 |

14-POCKET LEATHER EXTRA CAPACITY ELECTRICIAN'S TOOL POUCH

- › 10" x 10"
- › 4 Large gusseted utility pockets and 2 preformed plier pockets.
- › 4 Screwdriver slots, 12" tape rule holder, secured T-type tape holder with swivel rivet.
- › 2-3/4" Belt slots.
- › Additional features: Sectioned pocket for torpedo level, multi-purpose tool snap, scratch awl pocket and pencil holders.
- › Heavy-duty, top grain leather.



| Product # | Weight Lbs. |
|---------------|-------------|
| J95030 | 1.43 |

2-POCKET LEATHER CABLE SPLICER HOLDER

- › Heavy-duty top grain saddle leather.
- › 2 flared pockets for cable splicer, knife and scissors.
- › 2-1/2" belt slots.



| Product # | Weight Lbs. |
|---------------|-------------|
| J95170 | 0.17 |

FACOM® SAFETY GLOVES

- › Silicon leather to help provide mechanical protection.
- › Worn over latex insulating gloves.



| Product # | Size In. | Length In. | Weight Lbs. |
|---------------------|----------|------------|-------------|
| FT-BC.109VSE | 9 | 11-13/16 | 0.36 |
| FT-BC.110VSE | 10 | 12-19/32 | 0.43 |



PROTO

**YOU'VE GOT TO PUT IN YOUR TIME
TO BE A MASTER TRADESMAN. SO DO YOUR TOOLS.**

Our plumbing and HVAC line includes master sets, by trade, featuring sockets, wrenches, pliers, screwdrivers, striking, cutting, and specialty tools. Just as important, these sets build on one another as you advance in your trade. So you can simply add a few tools or next-level sets without duplicating what you already own. Best of all, like every tool in this catalog, our plumbing and HVAC tools are built to the highest industry standards and warranted to become grizzled, uber-efficient veterans like you.

PLUMBING AND HVAC TOOLS

3/4" INCH PROTO® 724SL



Heavy-Duty Cast Iron Pipe Wrenches

PROTO

105 PIECE BASIC TOOL SET

Product #: **JTS-0105HVAC**



- › 105 Pieces.
- › 3/8" Drive Tools.
- › Designed for fastener sizes 3/8" - 7/8".
- › Contains: 28 Sockets and Accessories, 26 Wrenches, 7 Striking and Struck Tools, 8 Pliers, 13 Screwdrivers, 23 Miscellaneous Tools.
- › Weight: 40.36 lbs.



Representative Image; Contents May Differ

| Contents | Description |
|----------|---|
| J5270A | Adapter, Universal Joint 3/8" DR |
| J86012 | Chisel, Cold 1/2" Super Duty |
| J86058 | Chisel, Cold 5/8" Super Duty |
| J5259 | Extension, 3/8" DR 1-3/4" |
| J5260 | Extension, 3/8" DR 3" |
| J5260-06 | Extension, 3/8" DR 6" |
| 20-001 | Hacksaw, High Tension Low Profile 12" |
| 15-809 | Hacksaw, Metal Mini |
| 54-016 | Hammer, Ball Pein Hickory 16 oz. |
| J4980 | Hex Key, 13 Piece Standard Set |
| J2108 | Holder, Punch and Chisel |
| 10-788 | Knife, QuickChange™ Retractable Blade Utility |
| 43-609 | Level, FatMax® Xtreme™ Torpedo 9" |
| J2370 | Mirror, Inspect Circle 7/8" |
| J9206H | Nut Driver, 3/16" Hollow Shaft |
| J9208H | Nut Driver, 1/4" Hollow Shaft |
| J9210H | Nut Driver, 5/16" Hollow Shaft |
| J9212H | Nut Driver, 3/8" Hollow Shaft |

| Contents | Description |
|----------|--|
| J9216H | Nut Driver, 1/2" Hollow Shaft |
| J207G | Pliers, Diagonal Cutting with Grip 7-5/16" |
| J252G | Pliers, Hose Clamp with Grip 7-3/4" |
| J291NC | Pliers, Locking Straight 7" |
| J228G | Pliers, Needle-Nose Long Handle 7-25/32" |
| J240G | Pliers, Needle-Nose Long Reach 11-9/16" |
| J276G | Pliers, Slip-Joint with Grip 6-9/16" |
| J260SG | Pliers, Tongue and Groove 10-3/16" with Grip |
| J299 | Pliers, Wire Stripper/Crimper 8-1/2" |
| J4029 | Puller Set Box |
| J413/8 | Punch, Center |
| J48018 | Punch, Pin 1/8" Super Duty |
| J48316 | Punch, Pin 3/16" Super Duty |
| J5249 | Ratchet, 3/8" DR |
| 28-240 | Scraper, Flexible Nylon 1-1/4" |
| 66-095 | Screwdriver, Vinyl Grip |
| 65-903 | Screwdriver, Vinyl Grip Phillips® 3 PT x 3" |
| 66-565P | Screwdriver, 6 Piece Stanley® Vinyl Grip |





| Contents | Description |
|----------|--------------------------------------|
| J5212 | Socket, 3/8" DR 3/8" 12 PT |
| J5214 | Socket, 3/8" DR 7/16" 12 PT |
| J5216 | Socket, 3/8" DR 1/2" 12 PT |
| J5218 | Socket, 3/8" DR 9/16" 12 PT |
| J5220 | Socket, 3/8" DR 5/8" 12 PT |
| J5222 | Socket, 3/8" DR 11/16" 12 PT |
| J5224 | Socket, 3/8" DR 3/4" 12 PT |
| J5226 | Socket, 3/8" DR 13/16" 12 PT |
| J5228 | Socket, 3/8" DR 7/8" 12 PT |
| J5012 | Socket, 3/8" DR 3/8" 12 PT Deep |
| J5014 | Socket, 3/8" DR 7/16" 12 PT Deep |
| J5016 | Socket, 3/8" DR 1/2" 12 PT Deep |
| J5018 | Socket, 3/8" DR 9/16" 12 PT Deep |
| J5020 | Socket, 3/8" DR 5/8" 12 PT Deep |
| J5022 | Socket, 3/8" DR 11/16" 12 PT Deep |
| J5024 | Socket, 3/8" DR 3/4" 12 PT Deep |
| J5026 | Socket, 3/8" DR 13/16" 12 PT Deep |
| J5028 | Socket, 3/8" DR 7/8" 12 PT Deep |
| J7210PF | Socket, Power 3/8" DR 5/16" Magnetic |
| J7212PF | Socket, Power 3/8" DR 3/8" Magnetic |
| J7214PF | Socket, Power 3/8" DR 7/16" Magnetic |
| J7216PF | Socket, Power 3/8" DR 1/2" Magnetic |
| J7218PF | Socket, Power 3/8" DR 9/16" Magnetic |
| 33-725 | Tape Rule, FatMax® 1-1/4" x 25' |
| 518160M | Tote, Stanley® FatMax® 18" |
| J350 | Tubing Cutter |
| J351 | Tubing Flaring Tool |
| J708G | Wrench, Adjustable 8" Grip |

| Contents | Description |
|----------|---|
| J712G | Wrench, Adjustable 12" Grip |
| J812HD | Wrench, Pipe 12" |
| J1111 | Wrench, Ratchet Refrigeration, 1/4" - 3/16" Sq. x 9/16" |
| J1112 | Wrench, Ratchet Refrigeration, 3/8" - 5/16" Sq. x 1/4" |
| J1208A | Wrench, Combination 1/4" 12 PT |
| J1210A | Wrench, Combination 5/16" 12 PT |
| J1212ASD | Wrench, Combination 3/8" 12 PT |
| J1214ASD | Wrench, Combination 7/16" 12 PT |
| J1216ASD | Wrench, Combination 1/2" 12 PT |
| J1218ASD | Wrench, Combination 9/16" 12 PT |
| J1220ASD | Wrench, Combination 5/8" 12 PT |
| J1222ASD | Wrench, Combination 11/16" 12 PT |
| J1224ASD | Wrench, Combination 3/4" 12 PT |
| J1226ASD | Wrench, Combination 13/16" 12 PT |
| J1228ASD | Wrench, Combination 7/8" 12 PT |
| J3764 | Wrench, Flare Nut 3/8" x 7/16" 6 PT |
| J3768 | Wrench, Flare Nut 1/2" x 9/16" 6 PT |
| J3772 | Wrench, Flare Nut 5/8" x 11/16" 6 PT |
| J3812 | Wrench, Flare Nut Ratcheting 3/8" |
| J3814 | Wrench, Flare Nut Ratcheting 7/16" |
| J3816 | Wrench, Flare Nut Ratcheting 1/2" |
| J3818 | Wrench, Flare Nut Ratcheting 9/16" |
| J3820 | Wrench, Flare Nut Ratcheting 5/8" |
| J3822 | Wrench, Flare Nut Ratcheting 11/16" |
| J3824 | Wrench, Flare Nut Ratcheting 3/4" |

70 PIECE STARTER TOOL SET

Product #: **JTS-0070HVAC**



- ▶ 70 Pieces.
- ▶ Contains: 19 Wrenches, 7 Striking and Struck Tools, 8 Pliers, 12 Screwdrivers, 24 Miscellaneous Tools.
- ▶ Weight: 45 lbs.



Representative Image; Contents May Differ

| Contents | Description |
|----------|---|
| J86012 | Chisel, Cold 1/2" Super Duty |
| J86058 | Chisel, Cold 5/8" Super Duty |
| 20-001 | Hacksaw, High Tension Low Profile 12" |
| 15-809 | Hacksaw, Metal Mini |
| 54-016 | Hammer, Ball Pein Hickory 16 oz. |
| J4980 | Hex Key, 13 Piece Standard Set |
| J2108 | Holder, Punch and Chisel |
| 10-788 | Knife, Utility QuickChange™ Retractable Blade |
| 43-609 | Level, FatMax® Xtreme™ Torpedo 9" |
| J2370 | Mirror, Inspect Circle 7/8" |
| J9208H | Nut Driver, 1/4" Hollow Shaft |
| J9210H | Nut Driver, 5/16" Hollow Shaft |
| J9212H | Nut Driver, 3/8" Hollow Shaft |
| J9216H | Nut Driver, 1/2" Hollow Shaft |
| J207G | Pliers, Diagonal Cutting with Grip 7-5/16" |
| J252G | Pliers, Hose Clamp with Grip 7-3/4" |
| J291NC | Pliers, Locking Straight 7" |
| J228G | Pliers, Needle-Nose Long Handle 7-25/32" |
| J240G | Pliers, Needle-Nose Long Reach 11-9/16" |
| J276G | Pliers, Slip-Joint with Grip 6-9/16" |
| J260SG | Pliers, Tongue and Groove 10-3/16" with Grip |
| J299 | Pliers, Wire Stripper/Crimper 8-1/2" |
| J4029 | Puller Set Box |
| J413/8 | Punch, Center |
| J48018 | Punch, Pin 1/8" Super Duty |
| J48316 | Punch, Pin 3/16" Super Duty |
| 28-240 | Scraper, Flexible Nylon 1-1/4" |

| Contents | Description |
|----------|---|
| 66-095 | Screwdriver, Vinyl Grip |
| 65-903 | Screwdriver, Vinyl Grip Phillips® 3 PT x 3" |
| 66-565P | Screwdriver, 6 Piece Stanley® Vinyl Grip |
| 33-725 | Tape Rule, FatMax® 1-1/4" x 25' |
| 518160M | Tote, Stanley® FatMax® 18" |
| J350 | Tubing Cutter |
| J351 | Tubing Flaring Tool |
| J708G | Wrench, Adjustable, 8" Grip |
| J712G | Wrench, Adjustable, 12" Grip |
| J1208A | Wrench, Combination 1/4" 12 PT |
| J1210A | Wrench, Combination 5/16" 12 PT |
| J1212ASD | Wrench, Combination 3/8" 12 PT |
| J1214ASD | Wrench, Combination 7/16" 12 PT |
| J1216ASD | Wrench, Combination 1/2" 12 PT |
| J1218ASD | Wrench, Combination 9/16" 12 PT |
| J1220ASD | Wrench, Combination 5/8" 12 PT |
| J1222ASD | Wrench, Combination 11/16" 12 PT |
| J1224ASD | Wrench, Combination 3/4" 12 PT |
| J1226ASD | Wrench, Combination 13/16" 12 PT |
| J1228ASD | Wrench, Combination 7/8" 12 PT |
| J3764 | Wrench, Flare Nut 3/8" x 7/16" 6 PT |
| J3768 | Wrench, Flare Nut 1/2" x 9/16" 6 PT |
| J3772 | Wrench, Flare Nut 5/8" x 11/16" 6 PT |
| J812HD | Wrench, Pipe 12" |
| J1111 | Wrench, Ratchet Refrigeration, 1/4" - 3/16" Sq. x 9/16" |
| J1112 | Wrench, Ratchet Refrigeration, 3/8" - 5/16" Sq. x 1/4" |



35 PIECE HVAC ADD-ON SET

Product #: JTS-0035HVAC



- › 35 Pieces.
- › 3/8" Drive Tools.
- › Designed for fastener sizes 3/8" - 7/8".
- › Tools only.
- › Contains: 28 Sockets and Accessories, 7 Wrenches.
- › Weight: 7 lbs.



Representative Image; Contents May Differ

| Contents | Description |
|----------|----------------------------------|
| J5270A | Adapter, Universal Joint 3/8" DR |
| J5259 | Extension 3/8" DR, 1-3/4" |
| J5260 | Extension, 3/8" DR 3" |
| J5260-06 | Extension, 3/8" DR 6" |
| J5249 | Ratchet, 3/8" DR |
| J5212 | Socket, 3/8" DR 3/8" 12 PT |
| J5214 | Socket, 3/8" DR 7/16" 12 PT |
| J5216 | Socket, 3/8" DR 1/2" 12 PT |
| J5218 | Socket, 3/8" DR 9/16" 12 PT |
| J5220 | Socket, 3/8" DR 5/8" 12 PT |
| J5222 | Socket, 3/8" DR 11/16" 12 PT |
| J5224 | Socket, 3/8" DR 3/4" 12 PT |
| J5226 | Socket, 3/8" DR 13/16" 12 PT |
| J5228 | Socket, 3/8" DR 7/8" 12 PT |
| J5012 | Socket, 3/8" DR 3/8" 12 PT Deep |
| J5014 | Socket, 3/8" DR 7/16" 12 PT Deep |
| J5016 | Socket, 3/8" DR 1/2" 12 PT Deep |
| J5018 | Socket, 3/8" DR 9/16" 12 PT Deep |

| Contents | Description |
|----------|--------------------------------------|
| J5020 | Socket, 3/8" DR 5/8" 12 PT Deep |
| J5022 | Socket, 3/8" DR 11/16" 12 PT Deep |
| J5024 | Socket, 3/8" DR 3/4" 12 PT Deep |
| J5026 | Socket, 3/8" DR 13/16" 12 PT Deep |
| J5028 | Socket, 3/8" DR 7/8" 12 PT Deep |
| J7210PF | Socket, Power 3/8" DR 5/16" Magnetic |
| J7212PF | Socket, Power 3/8" DR 3/8" Magnetic |
| J7214PF | Socket, Power 3/8" DR 7/16" Magnetic |
| J7216PF | Socket, Power 3/8" DR 1/2" Magnetic |
| J7218PF | Socket, Power 3/8" DR 9/16" Magnetic |
| J3812 | Wrench, Flare Nut Ratcheting 3/8" |
| J3814 | Wrench, Flare Nut Ratcheting 7/16" |
| J3816 | Wrench, Flare Nut Ratcheting 1/2" |
| J3818 | Wrench, Flare Nut Ratcheting 9/16" |
| J3820 | Wrench, Flare Nut Ratcheting 5/8" |
| J3822 | Wrench, Flare Nut Ratcheting 11/16" |
| J3824 | Wrench, Flare Nut Ratcheting 3/4" |



37 PIECE PLUMBER'S TOOL SET

Product #: **JTS-0037PLUM**



- › 37 Pieces.
- › Contains: 10 Wrenches, 5 Striking and Struck Tools, 6 Pliers, 4 Screwdrivers, 12 Miscellaneous Tools.
- › Enhanced version of Proto® 90-731 Plumber's Tool Set.
- › Weight: 41 lbs.



Representative Image; Contents May Differ

| Contents | Description |
|----------|---|
| 95-112W | Flashlight, Stanley® Tripod - 20 Lumens |
| 20-001 | Hacksaw, High Tension Low Profile 12" |
| 15-809 | Hacksaw, Metal Mini |
| 54-732 | Hammer, Ball Pein Jacketed Graphite 32 oz. |
| 51-505 | Hammer, Jacketed Graphite Nailing CC - 16 oz. |
| 10-788 | Knife, Utility QuickChange™ Retractable Blade |
| 43-609 | Level, FatMax® Xtreme™ Torpedo 9" |
| J294WRXL | Pliers, Locking Curved Jaw with Cutter 7-15/32" |
| J240G | Pliers, Needle-Nose Long Reach 11-9/16" |
| J276G | Pliers, Slip-Joint with Grip 6-9/16" |
| J260SG | Pliers, Tongue and Groove 10-3/16" with Grip |
| J265SG | Pliers, Tongue and Groove 16" with Grip |
| 20-556 | Saw, FatMax® Jab |
| 15-334 | Saw, Sharptooth™ 15" 9 PT |
| 62-559 | Screwdriver, Prodriver™ Phillips® 3" x #1 |
| 62-561 | Screwdriver, Prodriver™ Phillips® 4" x #2 |
| 62-553 | Screwdriver, Prodriver™ Std 1/4" x 4" |

| Contents | Description |
|----------|--|
| 62-555 | Screwdriver, Prodriver™ Std 5/16" x 6" |
| 16-298 | Chisel, 3 Piece Stanley® Cold Chisel Set |
| 14-563 | Snip, Aviation MaxSteel® Straight |
| 33-725 | Tape Rule, FatMax® 1-1/4" x 25' |
| 518160M | Tote, Stanley® FatMax® 18" |
| J350 | Tubing Cutter |
| J351 | Tubing Flaring Tool |
| J708L | Wrench, Adjustable CliK-Stop® Chrome 8" |
| J712L | Wrench, Adjustable CliK-Stop® Chrome 12" |
| J801 | Wrench, Chain |
| J806HD | Wrench, Pipe Heavy-Duty 6" |
| J810HD | Wrench, Pipe Heavy-Duty 10" |
| J814HD | Wrench, Pipe Heavy-Duty 14" |
| J140-38 | Wrench, Pipe Internal 3/8" |
| J140-12 | Wrench, Pipe Internal 1/2" |
| J140-34 | Wrench, Pipe Internal 3/4" |
| J140-1 | Wrench, Pipe Internal 1" |





7 PIECE COMBINATION FLARE NUT WRENCH SET - 6 POINT

Product #: **J3700A**

- › Satin finish provides corrosion resistance and a slip-resistant grip.
- › Flare nut box end incorporates the TorquePlus™ system.
- › Weight (lbs): 2.24



| Contents | Size (in) | Point Size | Overall Length (in) |
|----------|-----------|------------|---------------------|
| J3751 | 3/8 | 6 | 5-11/16 |
| J3752 | 7/16 | 6 | 6-1/32 |
| J3753 | 1/2 | 6 | 6-7/16 |
| J3754 | 9/16 | 6 | 6-15/16 |
| J3755 | 5/8 | 6 | 7-5/8 |
| J3756 | 11/16 | 6 | 8-11/16 |
| J3757 | 3/4 | 6 | 9-3/16 |
| J25TR03C | Tool Roll | | |

ASME B107.21



7 PIECE COMBINATION FLARE NUT WRENCH SET - 12 POINT

Product #: **J3700AT**

- › Satin finish provides corrosion resistance and a slip-resistant grip.
- › 12 point flare nut box end allows for fine indexing, helping to improve speed and access.
- › Fits 4, 6 and 12 point fasteners.
- › Flare nut box end incorporates the TorquePlus™ system.
- › Weight (lbs): 2.24



| Contents | Size (in) | Point Size | Overall Length (in) |
|----------|-----------|------------|---------------------|
| J3751T | 3/8 | 12 | 5-11/16 |
| J3752T | 1/2 | 12 | 6-1/32 |
| J3753T | 7/16 | 12 | 6-7/16 |
| J3754T | 9/16 | 12 | 6-15/16 |
| J3755T | 5/8 | 12 | 7-5/8 |
| J3756T | 11/16 | 12 | 8-11/16 |
| J3757T | 3/4 | 12 | 9-3/16 |
| J25TR03C | Tool Roll | | |

ASME B107.21



SATIN COMBINATION FLARE NUT WRENCHES - 6 POINT

- › Satin finish provides corrosion resistance and a slip-resistant grip.
- › Flare nut box end incorporates the TorquePlus™ system.



| Product # | Size (in) (A) | Throat Depth (in) (B) | Outside Head Width (in) (C) | Head Thickness (in) (D) | Throat Depth (in) (B1) | Outside Head Width (in) (C1) | Head Thickness (in) (D1) | Overall Length (in) | Weight (lbs) |
|--------------|---------------|-----------------------|-----------------------------|-------------------------|------------------------|------------------------------|--------------------------|---------------------|--------------|
| J3751 | 3/8 | 7/16 | 25/32 | 11/32 | 19/64 | 51/64 | 23/65 | 5-11/16 | 0.12 |
| J3752 | 7/16 | 33/64 | 7/8 | 3/8 | 23/64 | 59/64 | 13/32 | 6-1/32 | 0.16 |
| J3753 | 1/2 | 19/32 | 31/32 | 3/8 | 25/64 | 1-1/32 | 13/32 | 6-7/16 | 0.21 |
| J3754 | 9/16 | 43/64 | 1-3/64 | 7/16 | 26/64 | 1-11/64 | 15/32 | 6-15/16 | 0.34 |
| J3755 | 5/8 | 47/64 | 1-3/32 | 7/16 | 33/64 | 1-9/64 | 15/32 | 7-5/8 | 0.45 |
| J3756 | 11/16 | 51/64 | 1-3/16 | 1/2 | 9/16 | 1-13/32 | 17/32 | 8-11/16 | 0.45 |
| J3757 | 3/4 | 57/64 | 1-7/32 | 1/2 | 9/16 | 1-9/16 | 17/32 | 9-3/16 | 0.49 |

ASME B107.100



SATIN COMBINATION FLARE NUT WRENCHES - 12 POINT

- › Satin finish provides corrosion resistance and a slip-resistant grip.
- › 12 point flare nut box end allows for fine indexing, helping to improve speed and access.
- › Fits 4, 6 and 12 point fasteners.
- › Flare nut box end incorporates the TorquePlus™ system.



| Product # | Size (in) (A) | Throat Depth (in) (B) | Outside Head Width (in) (C) | Head Thickness (in) (D) | Throat Depth (in) (B1) | Outside Head Width (in) (C1) | Head Thickness (in) (D1) | Overall Length (in) | Weight (lbs) |
|-----------|---------------|-----------------------|-----------------------------|-------------------------|------------------------|------------------------------|--------------------------|---------------------|--------------|
| J3751T | 3/8 | 7/16 | 25/32 | 11/32 | 19/64 | 51/64 | 3/8 | 5-11/16 | 0.13 |
| J3752T | 1/2 | 33/64 | 7/8 | 3/8 | 23/64 | 29/32 | 13/32 | 6-1/32 | 0.18 |
| J3753T | 7/16 | 19/32 | 31/32 | 3/8 | 25/64 | 1-1/32 | 13/32 | 6-7/16 | 0.19 |
| J3754T | 9/16 | 43/64 | 1-3/64 | 7/16 | 29/64 | 1-3/64 | 15/32 | 6-15/16 | 0.25 |
| J3755T | 5/8 | 47/64 | 1-3/32 | 7/16 | 33/64 | 1-19/64 | 15/32 | 7-5/8 | 0.32 |
| J3756T | 11/16 | 51/64 | 1-3/16 | 1/2 | 9/16 | 1-13/32 | 17/32 | 8-11/16 | 0.42 |
| J3757T | 3/4 | 57/64 | 1-7/32 | 1/2 | 9/16 | 1-9/16 | 17/32 | 9-3/16 | 0.46 |

ASME B107.100

3 PIECE DOUBLE END FLARE NUT WRENCH SET - 6 POINT

Product #: J3760

- › Satin finish provides corrosion resistance and a slip-resistant grip.
- › Flare nut box ends incorporate the TorquePlus™ system.
- › Weight (lbs): 0.97



| Contents | Size (in) | Point Size | Overall Length (in) |
|----------|-------------|------------|---------------------|
| J3764 | 3/8 x 7/16 | 6 | 6-1/4 |
| J3768 | 1/2 x 9/16 | 6 | 7-1/2 |
| J3772 | 5/8 x 11/16 | 6 | 8-3/4 |
| J25TR17C | Tool Roll | | 10 |

ASME B107.100

5 PIECE METRIC DOUBLE END FLARE NUT WRENCH SET - 6 POINT

Product #: J3700M

- › Satin finish provides corrosion resistance and a slip-resistant grip.
- › Flare nut box ends incorporate the TorquePlus™ system.
- › Weight (lbs): 1.25



METRIC



| Contents | Size (mm) | Point Size | Overall Length (in) |
|----------|-----------|------------|---------------------|
| J3707M | 7 x 8 | 6 | 5-11/16 |
| J3709M | 9 x 11 | 6 | 6-5/16 |
| J3710M | 10 x 12 | 6 | 6-15/16 |
| J3713M | 13 x 14 | 6 | 7-9/16 |
| J3715M | 15 x 17 | 6 | 7-63/64 |
| J25TR06C | Tool Roll | | |

ASME B107.100

3 PIECE DOUBLE END FLARE NUT WRENCH SET - 12 POINT

Product #: **J3760T**

- › Satin finish provides corrosion resistance and a slip-resistant grip.
- › 12 point flare nut box end allows for fine indexing, helping to improve speed and access.
- › Fits 4, 6 and 12 point fasteners.
- › Flare nut box ends incorporate the TorquePlus™ system.
- › Weight (lbs): 0.97



| Contents | Size (in) | Point Size | Overall Length (in) |
|----------|-------------|------------|---------------------|
| J3764T | 3/8 x 7/16 | 12 | 6-1/4 |
| J3768T | 1/2 x 9/16 | 12 | 7-1/2 |
| J3772T | 5/8 x 11/16 | 12 | 8-3/4 |
| J25TR17C | Tool Roll | | |

ASME B107.100



5 PIECE METRIC DOUBLE END FLARE NUT WRENCH SET - 12 POINT

Product #: **J3700MT**

METRIC

- › Satin finish provides corrosion resistance and a slip-resistant grip.
- › 12 point flare nut box end allows for fine indexing, helping to improve speed and access.
- › Fits 4, 6 and 12 point fasteners.
- › Flare nut ends incorporate the TorquePlus™ system.
- › Weight (lbs): 1.29



| Contents | Size (in) | Point Size | Overall Length (in) |
|----------|-----------|------------|---------------------|
| J3707MT | 7 x 8 | 12 | 5-11/16 |
| J3709MT | 9 x 11 | 12 | 6-5/16 |
| J3710MT | 10 x 12 | 12 | 6-15/16 |
| J3713MT | 13 x 14 | 12 | 7-9/16 |
| J3715MT | 15 x 17 | 12 | 7-63/64 |
| J25TR06C | Tool Roll | | |

ASME B107.100



SATIN DOUBLE END FLARE NUT WRENCHES - 6 POINT

- › Satin finish provides corrosion resistance and a slip-resistant grip.
- › Flare nut box ends incorporate the TorquePlus™ system.



| Product # | Size (in) | Mouth Width (in) (A) | Outside Head Width (in) (C) | Head Thickness (in) (D) | Mouth Width (in) (A1) | Outside Head Width (in) (C1) | Head Thickness (in) (D1) | Overall Length (in) | Weight (lbs) |
|--------------|-------------|----------------------|-----------------------------|-------------------------|-----------------------|------------------------------|--------------------------|---------------------|--------------|
| J3764 | 3/8 x 7/16 | 19/64 | 51/64 | 11/32 | 23/64 | 57/64 | 3/8 | 6-1/4 | 0.18 |
| J3768 | 1/2 x 9/16 | 25/64 | 31/32 | 3/8 | 13/32 | 1-3/64 | 7/16 | 7-1/2 | 0.27 |
| J3772 | 5/8 x 11/16 | 33/64 | 1-7/64 | 7/16 | 37/64 | 1-13/64 | 31/64 | 8-3/4 | 0.38 |

ASME B107.100

SATIN METRIC DOUBLE END FLARE NUT WRENCHES - 6 POINT

- › Satin finish provides corrosion resistance and a slip-resistant grip.
- › Flare nut box ends incorporate the TorquePlus™ system.



| Product # | Size (mm) | Mouth Width (in) (A) | Outside Head Width (in) (C) | Head Thickness (in) (D) | Mouth Width (in) (A1) | Outside Head Width (in) (C1) | Head Thickness (in) (D1) | Overall Length (in) | Weight (lbs) |
|-----------|-----------|----------------------|-----------------------------|-------------------------|-----------------------|------------------------------|--------------------------|---------------------|--------------|
| J3707M | 7 x 8 | 7/32 | 43/64 | 19/64 | 15/64 | 3/4 | 21/64 | 5-11/16 | 0.12 |
| J3709M | 9 x 11 | 9/32 | 13/16 | 23/64 | 11/32 | 29/32 | 25/64 | 6-5/16 | 0.17 |
| J3710M | 10 x 12 | 9/32 | 55/64 | 25/64 | 11/32 | 61/64 | 25/64 | 6-15/16 | 0.22 |
| J3713M | 13 x 14 | 3/8 | 1-1/64 | 25/64 | 7/16 | 1-3/32 | 29/64 | 7-9/16 | 0.26 |
| J3715M | 15 x 17 | 7/16 | 1-7/64 | 29/64 | 1/2 | 1-3/16 | 31/64 | 7-63/64 | 0.37 |
| J3716M | 16 x 18 | 1/2 | 1-9/64 | 29/64 | 37/64 | 1-15/64 | 33/64 | 8-13/16 | 0.39 |
| J3719M | 19 x 21 | 37/64 | 1-9/32 | 35/64 | 5/8 | 1-3/8 | 37/64 | 9-3/8 | 0.6 |



ASME B107.100

SATIN DOUBLE END FLARE NUT WRENCHES - 12 POINT

- › Satin finish provides corrosion resistance and a slip-resistant grip.
- › 12 point flare nut box end allows for fine indexing, helping to improve speed and access.
- › Fits 4, 6 and 12 point fasteners.
- › Flare nut box ends incorporate the TorquePlus™ system.



| Product # | Size (in) | Mouth Width (in) (A) | Outside Head Width (in) (C) | Head Thickness (in) (D) | Mouth Width (in) (A1) | Outside Head Width (in) (C1) | Head Thickness (in) (D1) | Overall Length (in) | Weight (lbs) |
|-----------|-------------|----------------------|-----------------------------|-------------------------|-----------------------|------------------------------|--------------------------|---------------------|--------------|
| J3764T | 3/8 x 7/16 | 19/64 | 51/64 | 11/32 | 23/64 | 57/64 | 3/8 | 6-1/4 | 0.18 |
| J3768T | 1/2 x 9/16 | 25/64 | 31/32 | 3/8 | 13/32 | 1-1/16 | 7/16 | 7-1/2 | 0.27 |
| J3772T | 5/8 x 11/16 | 33/64 | 1-7/64 | 7/16 | 37/64 | 1-13/64 | 31/64 | 8-3/4 | 0.38 |



ASME B107.100

SATIN METRIC DOUBLE END FLARE NUT WRENCHES - 12 POINT

- › Satin finish provides corrosion resistance and a slip-resistant grip.
- › Flare nut box ends incorporate the TorquePlus™ system.
- › 12 point flare nut box end allows for fine indexing, helping to improve speed and access.
- › Fits 4, 6 and 12 point fasteners.



| Product # | Size (mm) | Throat Depth (in) (B) | Outside Head Width (in) (C) | Head Thickness (in) (D) | Throat Depth (in) (B1) | Outside Head Width (in) (C1) | Head Thickness (in) (D1) | Overall Length (in) | Weight (lbs) |
|-----------|-----------|-----------------------|-----------------------------|-------------------------|------------------------|------------------------------|--------------------------|---------------------|--------------|
| J3707MT | 7 x 8 | 7/32 | 43/64 | 19/64 | 15/64 | 3/4 | 21/64 | 5-11/16 | 0.11 |
| J3709MT | 9 x 11 | 9/32 | 13/16 | 23/64 | 11/32 | 29/32 | 25/64 | 6-5/16 | 0.16 |
| J3710MT | 10 x 12 | 9/32 | 55/64 | 25/64 | 11/32 | 61/64 | 25/64 | 6-15/16 | 0.21 |
| J3713MT | 13 x 14 | 3/8 | 1-1/64 | 25/64 | 7/16 | 1-3/32 | 29/64 | 7-9/16 | 0.24 |
| J3715MT | 15 x 17 | 7/16 | 1-7/64 | 29/64 | 1/2 | 1-3/16 | 31/64 | 7-63/64 | 0.33 |
| J3716MT | 16 x 18 | 1/2 | 1-9/64 | 29/64 | 37/64 | 1-15/64 | 33/64 | 8-13/16 | 0.36 |
| J3719MT | 19 x 21 | 37/64 | 1-9/32 | 35/64 | 5/8 | 1-3/8 | 37/64 | 9-7/16 | 0.39 |



ASME B107.100



7 PIECE RATCHETING FLARE NUT WRENCH SET - 12 POINT

Product #: **J3800A**

- ▶ Black oxide finish.
- ▶ Non-reflective black oxide finish for use where non-plated products are required.
- ▶ 12 Point flare nut box end allows for fine indexing, helping to improve speed and access.
- ▶ Pivoting head allows user to place the wrench over the connected pipes to reach the fastener.
- ▶ Weight (lbs): 1.93



| Contents | Size (in) | Point Size | Overall Length (in) |
|----------|-----------|------------|---------------------|
| J3812 | 3/8 | 12 | 5-7/16 |
| J3814 | 7/16 | 12 | 5-7/16 |
| J3816 | 1/2 | 12 | 5-7/16 |
| J3818 | 9/16 | 12 | 7-1/4 |
| J3820 | 5/8 | 12 | 7-1/4 |
| J3822 | 11/16 | 12 | 7-1/4 |
| J3824 | 3/4 | 12 | 7-1/4 |
| J25TR03C | Tool Roll | | |

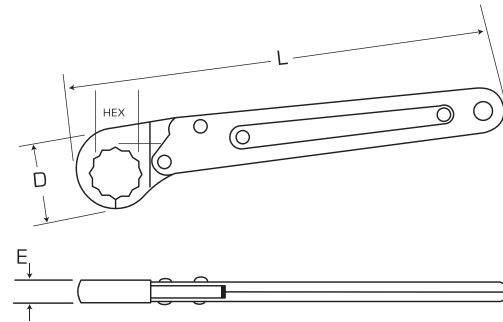
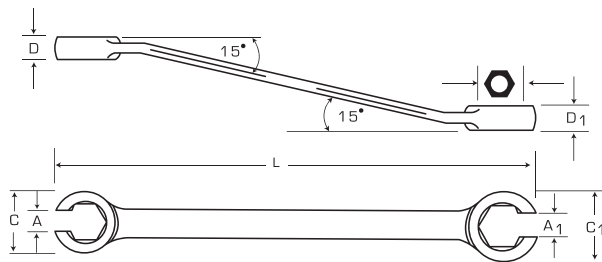

BLACK OXIDE RATCHETING FLARE NUT WRENCHES - 12 POINT

- ▶ Black oxide finish.
- ▶ Non-reflective black oxide finish for use where non-plated products are required.
- ▶ 12 Point flare nut box end allows for fine indexing, helping to improve speed and access.
- ▶ Pivoting head allows user to place the wrench over the connected pipes to reach the fastener.



| Product # | Size (in) | Outside Head Width (in) (C) | Head Thickness (in) (D) | Overall Length (in) | Weight (lbs) |
|--------------|-----------|-----------------------------|-------------------------|---------------------|--------------|
| J3812 | 3/8 | 1 | 9/32 | 5-7/16 | 0.17 |
| J3814 | 7/16 | 1 | 9/32 | 5-7/16 | 0.17 |
| J3816 | 1/2 | 1 | 9/32 | 5-7/16 | 0.17 |
| J3818 | 9/16 | 1-5/16 | 3/8 | 7-1/4 | 0.31 |
| J3820 | 5/8 | 1-5/16 | 3/8 | 7-1/4 | 0.31 |
| J3822 | 11/16 | 1-5/16 | 3/8 | 7-1/4 | 0.31 |
| J3824 | 3/4 | 1-5/16 | 3/8 | 7-1/4 | 0.31 |
| J3826 | 13/16 | 1-11/16 | 7/16 | 9-3/8 | 0.58 |
| J3828 | 7/8 | 1-11/16 | 7/16 | 9-3/8 | 0.58 |
| J3830 | 15/16 | 1-11/16 | 1/2 | 9-3/8 | 0.58 |
| J3832 | 1 | 1-11/16 | 1/2 | 9-3/8 | 0.58 |

REFRIGERATION WRENCHES

- › Full polish finish provides corrosion resistance and easy to clean surfaces.
- › Designed for servicing automotive, commercial, and residential air conditioners, refrigeration units and freezers.
- › Hex openings are used for packing gland fittings, mounting bolts, clutch bolts, tubing fittings, dust cap nuts, and oil check plugs.
- › Square openings are used on male service valves, plug fittings, compressor valves, and refrigerant charging tanks.
- › Reversing switch lever allows for easy changes in turning direction which helps improve speed.



| Product # | Size (in) | Size (in) | Overall Length (in) | Weight (lbs) |
|--------------|-------------------|----------------|---------------------|--------------|
| J1111 | 1/4 x 3/16 Square | 9/16 x 1/2 Hex | 6-3/4 | 0.35 |
| J1112 | 3/8 x 5/16 Square | 1/4 x 3/16 Hex | 5-1/2 | 0.25 |



FACOM® SATIN MONKEY WRENCHES



- › Satin finish provides corrosion resistance and a slip-resistant grip.
- › Sturdy, wide-opening tools for heavy-duty work on farms and building sites.
- › Fixed jaw/handle and worm gear made from hardened steel.
- › Smooth jaw faces help prevent marring of fastener surfaces.

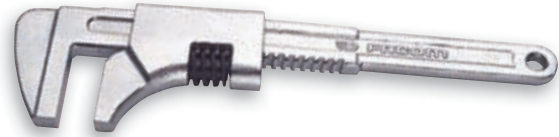

| Product # | Max Opening (in) | Jaw Depth (in) | Jaw Thickness (in) | Height (in) | Overall Length (in) | Weight (lbs) |
|-------------------|------------------|----------------|--------------------|-------------|---------------------|--------------|
| FA-105.230 | 2-3/8 | 1-25/32 | 25/32 | 19/32 | 9-1/16 | 1.15 |
| FA-105.280 | 2-3/4 | 1-11/32 | 21/32 | 25/32 | 11-1/32 | 1.79 |
| FA-105.375 | 3-1/8 | 1-25/32 | 7/8 | 7/8 | 14-23/32 | 3.36 |

PROTO-GRIP™ CAST IRON PIPE WRENCHES

- › Gripping jaw teeth and spring-loaded hook jaw; allow one-hand operation or hands free option along with a ratcheting action for job speed.
- › Standard handle lengths with wide gripping surface for increased comfort on all jobs.
- › Forged steel jaw provides outstanding strength.
- › Heel Jaw designed to work in both directions.
- › Spring hook jaw provides a ratcheting function making threaded pipe fitting efficient.
- › Hanging hole for storage.
- › Field repairable by removing the rivet pin located on the bottom side of the jaw.
- › Replacement parts available.



| Product # | Max Opening (in) | Overall Length (in) | Weight (lbs) |
|---------------|------------------|---------------------|--------------|
| J810PG | 1-1/2 | 10 | 1.98 |
| J814PG | 2 | 14 | 3.64 |





ALUMINUM PIPE WRENCHES

- › Light weight aluminum for less job fatigue.
- › Standard handle lengths with wide gripping surface for increased comfort and one-hand operation.
- › Forged steel jaw provides outstanding strength.
- › Large knurl and power threads provide fast, positive jaw adjustment.
- › Graduation markings on hook jaw show approximate opening for pipe sizes.
- › Riveted jaw pin for safety.
- › Hanging hole for storage.
- › Field repairable by removing the rivet pin located on the bottom side of the jaw.
- › Replacement parts available.

| Product # | Max Opening (in) | Overall Length (in) | Weight (lbs) |
|--------------|------------------|---------------------|--------------|
| J810A | 1-1/2 | 10 | 1.10 |
| J812A | 2 | 12 | 1.72 |
| J814A | 2 | 14 | 2.15 |
| J818A | 3-1/2 | 18 | 3.60 |
| J824A | 4 | 24 | 5.65 |
| J836A | 5 | 36 | 10.60 |
| J848A | 6 | 48 | 17.00 |



HEAVY-DUTY CAST IRON PIPE WRENCHES

- › Forged steel jaw provides outstanding strength.
- › Full floating hook jaw, provides instant grip, easy release.
- › Large knurl and power threads provide fast, positive jaw adjustment.

| Product # | Max Opening (in) | Overall Length (in) | Weight (lbs) |
|---------------|------------------|---------------------|--------------|
| J806HD | 3/4 | 6 | 0.45 |
| J808HD | 1 | 8 | 0.8 |
| J810HD | 1-1/2 | 10 | 1.76 |
| J812HD | 2 | 12 | 2.66 |
| J814HD | 2 | 14 | 3.76 |
| J818HD | 3-1/2 | 18 | 5.82 |
| J824HD | 4 | 24 | 9.58 |
| J836HD | 5 | 36 | 19.32 |
| J848HD | 6 | 48 | 35.36 |
| J860HD | 8 | 60 | 41.4 |

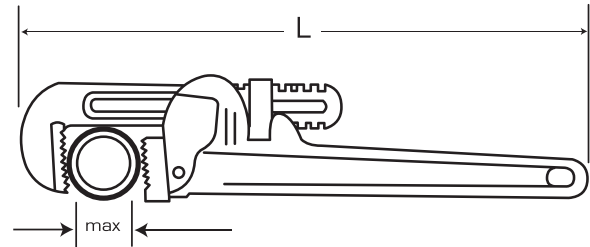

PIPE WRENCH REPLACEMENT PARTS

› Replacement parts for heavy-duty pipe wrenches.

| Parts For | Handle, Heel Jaw, and Pin Assemble | Weight (lbs) | Hook Jaw | Weight (lbs) | Heel Jaw and Pin | Weight (lbs) | Knurl | Weight (lbs) | Coil and Flat Spring | Weight (lbs) |
|---------------|------------------------------------|--------------|----------|--------------|------------------|--------------|-------|--------------|----------------------|--------------|
| J806HD | J806H | 0.33 | J806B | 0.11 | J806C | 0.02 | J806D | 0.03 | J806E | 0.01 |
| J808HD | J808H | 0.61 | J808B | 0.23 | J808C | 0.04 | J808D | 0.03 | J808E | 0.01 |
| J810HD | J810H | 1.20 | J810B | 0.45 | J810C | 0.08 | J810D | 0.07 | J810E | 0.01 |
| J812HD | J812H | 1.97 | J812B | 0.68 | J812C | 0.15 | J812D | 0.09 | J812E | 0.02 |
| J814HD | J814H | 2.79 | J814B | 0.97 | J814C | 0.15 | J814D | 0.11 | J814E | 0.03 |
| J818HD | J818H | 4.09 | J818B | 1.57 | J818C | 0.23 | J818D | 0.18 | J818E | 0.04 |
| J824HD | J824H | 7.35 | J824B | 2.36 | J824C | 0.32 | J824D | 0.31 | J824E | 0.06 |
| J836HD | J836H | 14.40 | J836B | 4.37 | J836C | 0.58 | J836D | 0.47 | J836E | 0.07 |
| J848HD | - | - | J848B | 7.31 | J848C | 0.72 | J848D | 0.68 | J848E | 0.11 |
| J860HD | - | - | J860B | 12.50 | J860C | 1.50 | J860D | 0.85 | J860E | 0.08 |

| Parts For | Hook Jaw | Weight (lbs) | Heel Jaw | Weight (lbs) | Pin | Weight (lbs) | Spring | Weight (lbs) |
|---------------|----------|--------------|----------|--------------|---------|--------------|---------|--------------|
| J810PG | J810PGB | 0.60 | J810PGC | 0.31 | J810PGD | 0.04 | J810PGE | 0.01 |
| J814PG | J814PGB | 0.84 | J814PGC | 0.29 | J814PGD | 0.08 | J814PGE | 0.01 |

4 PIECE INTERNAL PIPE WRENCH SET

Product #: **J140SET**

- › Ideal for removing broken threaded pipe ends, plugs, and fittings.
- › Installation and removal without thread damage.
- › Eccentric cam action engages wrench against the walls of the pipe.
- › Hex body allows for use of adjustable wrench for added torque.
- › Made from hardened steel and plated to help prevent rust.
- › Weight (lbs): 1.95

| Contents | Size (in) | Overall Length (in) |
|----------|-----------|---------------------|
| J140-38 | 3/8 | 3 |
| J140-34 | 3/4 | 3 |
| J140-12 | 1/2 | 3 |
| J140-1 | 1 | 3 |



INTERNAL PIPE WRENCHES

- › Ideal for removing broken threaded pipe ends pipe plugs and fittings.
- › Installation and removal without thread damage.
- › Eccentric cam action engages wrench against the walls of the pipe.
- › Hex body allows for use of adjustable wrench for added torque.
- › Made from hardened steel and plated to help prevent rust.

| Product # | Size (in) | Overall Length | |
|----------------|-----------|----------------|--------------|
| | | (in) | Weight (lbs) |
| J140-38 | 3/8 | 3 | 0.21 |
| J140-34 | 3/4 | 3 | 0.49 |
| J140-12 | 1/2 | 3 | 0.32 |
| J140-1 | 1 | 3 | 0.85 |



UNIVERSAL CHAIN WRENCH

- › Fits any shape pipe.
- › Forged steel handle has deep milled teeth.
- › Chain capacity rating: 6,200 lbs.

| Product # | Capacity Range | Overall Length (in) | Weight (lbs) |
|-------------|----------------|---------------------|--------------|
| J801 | 7/8 to 4 | 16-1/2 | 2.33 |



UNIVERSAL CHAIN WRENCH REPAIR KIT

- › Fits any shape pipe.
- › Chain capacity rating: 6,200 lbs.

| Product # | Overall Length (in) | Weight (lbs) |
|---------------|---------------------|--------------|
| J801RK | 6 1/5 | 0.73 |



CUSHION GRIP ADJUSTABLE WRENCHES

- › Soft cushion grip for additional comfort.
- › Extra wide jaw capacity.
- › Square jaw opening provides strength and tight fit.

| Product # | Max Opening (in) | Overall Length (in) | Weight (lbs) |
|--------------|------------------|---------------------|--------------|
| J704G | 1/2 | 4 | 0.13 |
| J706G | 15/16 | 6 | 0.25 |
| J708G | 1-1/8 | 8 | 0.59 |
| J710G | 1-5/16 | 10 | 0.8 |
| J712G | 1-1/2 | 12 | 1.61 |



ASME B107.100

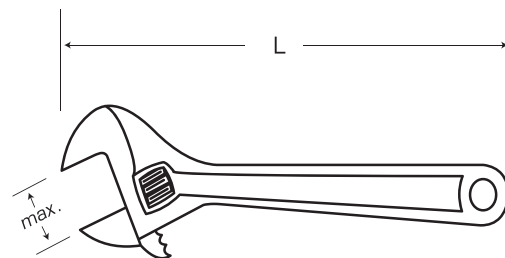

SATIN ADJUSTABLE WRENCHES

- › Satin finish provides corrosion resistance and a slip-resistant grip.
- › Extra wide jaw capacity.
- › Square jaw opening provides greater strength and better fit.
- › Rugged I-beam style handle and reinforced stress areas; radius corner design.

| Product # | Max Opening (in) | Overall Length (in) | Weight (lbs) |
|-------------|------------------|---------------------|--------------|
| J704 | 1/2 | 4 | 0.17 |
| J706 | 15/16 | 6 | 0.28 |
| J708 | 1-1/8 | 8 | 0.58 |
| J710 | 1-5/16 | 10 | 0.9 |
| J712 | 1-1/2 | 12 | 1.58 |
| J715 | 1-11/16 | 15 | 3 |
| J718 | 2-1/16 | 18 | 4.26 |
| J724 | 2-7/16 | 24 | 6.41 |



AS4984

ASME B107.100

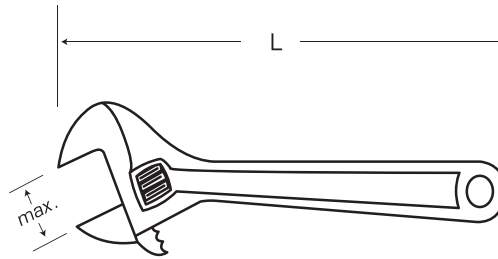

TUBING CUTTING AND FLARING SET

Product #: **J349**

- › Cuts tubing from 1/8" through 1-1/8" O.D. and puts 45° flare on tubing 3/16" through 5/8".
- › Weight (lbs): 4.40



| Contents | Description |
|----------|-------------------|
| J350 | Tubing Cutter |
| J351V | Flaring Block |
| J351Y | Flaring Yoke |
| J4029 | Steel Storage Box |



TUBING CUTTER

- › Cuts metal tubing from 1/8" through 1-1/8" O.D. quickly and cleanly.
- › Features heat-treated alloy steel cutting blade, special rollers, and heavy-duty screw mounted in durable steel frame.
- › Large screw-knob and retractable tubing reamer.



| Product # | Diameter Dial | Weight (lbs) |
|-------------|---------------|--------------|
| J350 | 350c | 0.82 |

TUBING FLARING TOOL

- › A complete flaring tool for tubing 3/16" through 5/8" O.D.
- › Includes multiple hole 45° V-block and flaring yoke with hardened, polished, ball-bearing mounted cone.
- › Ideal for use on copper tubing; not recommended for use on steel applications.



| Product # | V-Blocks Only | Yoke Only | Weight (lbs) |
|-------------|---------------|-----------|--------------|
| J351 | 351V | 351Y | 0.82 |



7 PIECE PROTO® HOLLOW SHAFT NUT DRIVER SET

Product #: **J9200H**

- › Full hollow shaft design for maximum bolt clearance.
- › One-piece shaft design for greater strength and durability.
- › Ideal for electronics, assembly, and various industrial applications.
- › Color coded handles for easy size identification.
- › Weight (lbs): 4.22

| Contents | Size (in) | Length (in) (L1) | Overall Length (in) (L) | ASME Spec. |
|----------|------------------|------------------|-------------------------|--------------|
| J9206H | 3/16 | 2-3/4 | 6-11/16 | ASME B107.12 |
| J9208H | 1/4 | 2-3/4 | 6-11/16 | ASME B107.12 |
| J9210H | 5/16 | 2-3/4 | 6-11/16 | ASME B107.12 |
| J9211H | 11/32 | 2-3/4 | 6-11/16 | ASME B107.12 |
| J9212H | 3/8 | 2-3/4 | 6-11/16 | ASME B107.12 |
| J9214H | 7/16 | 2-3/4 | 6-11/16 | ASME B107.12 |
| J9216H | 1/2 | 2-3/4 | 6-11/16 | ASME B107.12 |
| J9200CBB | Blow-Molded Case | | | |



11 PIECE PROTO® NUT DRIVER SET

Product #: J9200B

- › Precision formed, heat-treated hex openings.
- › Color coded handles for easy identification.
- › One-piece shaft design for greater strength and durability.
- › Weight (lbs): 4.22

| Contents | Size (in) | Length (in) (L1) | Overall Length (in) (L) | ASME Spec. |
|----------|------------------|------------------|-------------------------|--------------|
| J9206 | 3/16 | 2-3/4 | 6-11/16 | ASME B107.12 |
| J9207 | 7/32 | 2-3/4 | 6-11/16 | ASME B107.12 |
| J9208 | 1/4 | 2-3/4 | 6-11/16 | ASME B107.12 |
| J9209 | 9/32 | 2-3/4 | 6-11/16 | ASME B107.12 |
| J9210 | 5/16 | 2-3/4 | 6-11/16 | ASME B107.12 |
| J9211 | 11/32 | 2-3/4 | 6-11/16 | ASME B107.12 |
| J9212 | 3/8 | 2-3/4 | 6-11/16 | ASME B107.12 |
| J9214 | 7/16 | 2-3/4 | 7 | ASME B107.12 |
| J9216 | 1/2 | 2-3/4 | 7 | ASME B107.12 |
| J9218 | 9/16 | 2-3/4 | 7 | ASME B107.12 |
| J9220 | 5/8 | 2-3/4 | 7 | ASME B107.12 |
| J9200DPB | Blow-Molded Case | | | |



7 PIECE PROTO® NUT DRIVER SET

Product #: J9200C

- › Precision formed, heat-treated hex openings.
- › Color coded handles for easy identification.
- › One-piece shaft design for greater strength and durability.
- › Weight (lbs): 1.77

| Contents | Size (in) | Length (in) (L1) | Overall Length (in) (L) | ASME Spec. |
|----------|-----------|------------------|-------------------------|--------------|
| J9206 | 3/16 | 2-3/4 | 6-11/16 | ASME B107.12 |
| J9207 | 7/32 | 2-3/4 | 6-11/16 | ASME B107.12 |
| J9208 | 1/4 | 2-3/4 | 6-11/16 | ASME B107.12 |
| J9209 | 9/32 | 2-3/4 | 6-11/16 | ASME B107.12 |
| J9210 | 5/16 | 2-3/4 | 6-11/16 | ASME B107.12 |
| J9211 | 11/32 | 2-3/4 | 6-11/16 | ASME B107.12 |
| J9212 | 3/8 | 2-3/4 | 6-11/16 | ASME B107.12 |
| J25TR24C | Pouch | | | |



TRADITIONAL NUT DRIVERS

- › Full hollow shaft design for maximum bolt clearance (part numbers ending with "H").
- › One-piece shaft design for greater strength and durability.
- › Ideal for electronics, assembly, and various industrial applications.
- › Color coded handles for easy size identification.

| Product # | Size (in) | Size (mm) | Length (in) (L1) | Weight (lbs) |
|-----------|-----------|-----------|------------------|--------------|
| J9206H | 3/16 | – | 2-3/4 | 0.18 |
| J9208H | 1/4 | – | 2-3/4 | 0.18 |
| J9210H | 5/16 | – | 2-3/4 | 0.19 |
| J9211H | 11/32 | – | 2-3/4 | 0.22 |
| J9212H | 3/8 | – | 2-3/4 | 0.19 |
| J9214H | 7/16 | – | 2-3/4 | 0.27 |
| J9216H | 1/2 | – | 2-3/4 | 0.27 |
| J9206 | 3/16 | – | 2-3/4 | 0.20 |
| J9207 | 7/32 | – | 2-3/4 | 0.20 |
| J9208 | 1/4 | – | 2-3/4 | 0.19 |
| J9209 | 9/32 | – | 2-3/4 | 0.23 |
| J9210 | 5/16 | – | 2-3/4 | 0.23 |
| J9211 | 11/32 | – | 2-3/4 | 0.22 |
| J9212 | 3/8 | – | 2-3/4 | 0.23 |
| J9214 | 7/16 | – | 2-3/4 | 0.34 |
| J9216 | 1/2 | – | 2-3/4 | 0.34 |
| J9218 | 9/16 | – | 2-3/4 | 0.45 |
| J9220 | 5/8 | – | 2-3/4 | 0.50 |
| J9204M | – | 4 | 2-7/8 | 0.19 |
| J9205M | – | 5 | 2-7/8 | 0.19 |
| J92055M | – | 5.5 | 2-7/8 | 0.19 |
| J9206M | – | 6 | 2-7/8 | 0.19 |
| J9207M | – | 7 | 2-7/8 | 0.22 |
| J9208M | – | 8 | 2-7/8 | 0.22 |
| J9209M | – | 9 | 2-7/8 | 0.24 |
| J9210M | – | 10 | 2-7/8 | 0.29 |
| J9211M | – | 11 | 2-7/8 | 0.36 |
| J9212M | – | 12 | 2-7/8 | 0.36 |
| J9213M | – | 13 | 2-7/8 | 0.43 |
| J9214M | – | 14 | 2-7/8 | 0.50 |

 ASME B107.12

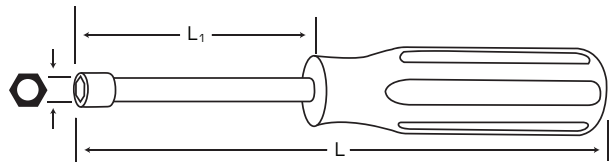

TONGUE AND GROOVE POWER-TRACK® II PLIERS

- › Precision milled undercut groove joint provides interlocking feature for powerful non-slip performance.
- › Special fastener ensures permanent assembly, yet allows for easy adjustment.
- › Angled teeth provide superior gripping power over standard right angled teeth.
- › Plastisol grips for added comfort.
- › Natural finish.



| Product # | Overall Length (in) (L) | Max. Opening (in) | Jaw Length (in) (A) | Jaw Width (in) (B) | Jaw Thickness (in) (C) | Weight (lbs) |
|---------------|-------------------------|-------------------|---------------------|--------------------|------------------------|--------------|
| J261SG | 4-5/8 | 15/32 | 7/8 | 13/16 | 3/16 | 0.15 |
| J262SG | 7-1/16 | 1-1/8 | 1-3/8 | 1-3/4 | 5/16 | 0.48 |
| J260SG | 10-3/16 | 2-1/8 | 1-15/16 | 2-3/4 | 13/32 | 1.00 |
| J264SG | 12 | 2-5/8 | 2-1/4 | 2-3/4 | 3/8 | 1.81 |
| J265SG | 16-7/8 | 4-1/16 | 3-3/8 | 4-1/8 | 17/32 | 3.50 |

ASME B107.500

SOFT JAW - CANNON PLUG PLIERS

- › Capacity of 3/4" to 2-1/2".
- › Four position pivot design provides greater concentricity.
- › Replaceable urethane padded jaws protect work piece from marking or scratching
- › Plastisol grips for added comfort.



| Product # | Overall Length (in) (L) | Max. Opening (in) | Replacement Item | Weight (lbs) |
|--------------|-------------------------|-------------------|------------------|--------------|
| J253G | 9-1/2 | 3/4 - 2-1/2 | 253GRK | 0.54 |

HOSE CLAMP PLIERS

- › Installs and removes wire spring tension clamps.
- › Two position jaws grip full range of clamp sizes.
- › Plastisol grips for added comfort.



| Product # | Overall Length (in) (L) | Weight (lbs) |
|--------------|-------------------------|--------------|
| J252G | 7-3/4 | 0.56 |



OPTIMUM GRIP LOCKING PLIERS

- › Jaw configuration combining straight, curved and convex profiles.
- › Versatile tool securely gripping round, flat and large objects.
- › Multi-use for plumbers, welders and others.



| Product # | Overall Length (in) (L) | Jaw Length (in) (A) | Jaw Width (in) (B) | Jaw Thickness (in) (C) | Weight (lbs) |
|---------------|-------------------------|---------------------|--------------------|------------------------|--------------|
| J280XL | 7-7/8 | 1-25/32 | 27/64 | 27/64 | 0.90 |
| J281XL | 9-27/32 | 2-5/32 | 1/2 | 1/2 | 1.43 |

LOCKING CHAIN PLIERS

- › Flexible heavy-duty, heat-treated chain which adjusts quickly around any shaped object even in awkward areas.
- › Use to remove oil filters or holding odd shapes for welding.
- › Replacement chain available - J262RC



| Product # | Overall Length (in) (L) | Jaw Width (in) (B) | Weight (lbs) |
|---------------|-------------------------|--------------------|--------------|
| J262XL | 9-27/32 | 45/64 | 1.98 |

LOCKING CHAIN PIPE CUTTER

- › 13 Alloy steel cutting wheels to evenly cut difficult to reach thin wall pipes by hand ratcheting.
- › Locking mechanism - no squeezing, avoids risk of lateral movement and misaligned cutting.
- › Butterfly screw for easy feeding as cutting.
- › Cuts through steel, copper, aluminum, and some stainless steels.
- › Great for exhaust pipe repair and removal.
- › Use in plumbing and heating.
- › Replacement chain available - J263RC



| Product # | Overall Length (in) (L) | Jaw Width (in) (B) | Weight (lbs) |
|---------------|-------------------------|--------------------|--------------|
| J263XL | 9-27/32 | 1-3/32 | 1.76 |

LOCKING CHAIN PIPE CUTTER PLUS

- › 15 Alloy steel cutting wheels to evenly cut difficult to reach piping up to 1/4 / 6 mm wall thickness by hand ratcheting.
- › Locking mechanism- no squeezing, avoids risk of lateral movement and misaligned cutting.
- › Cuts through galvanized steel, some stainless steels, copper, PVC, and aluminum.
- › Problem solving and time saving, ideal for plumbing, heating, joinery, and general maintenance.
- › Replacement chain available - J264RC



| Product # | Overall Length (in) (L) | Jaw Width (in) (B) | Weight (lbs) |
|---------------|-------------------------|--------------------|--------------|
| J264XL | 11-9/11 | 1-11/64 | 2.76 |

ROUND HEAD RATCHET REPAIR KITS

| Product # | Drive Size (in) | Ratchet # | Weight (lbs) |
|-----------------|-----------------|----------------------------------|--------------|
| J4752FRK | 1/4 | J4752F, J4752FBL | 0.10 |
| J5252FRK | 3/8 | J5252F, J5252FBL, J5257F | 0.60 |
| J5452FRK | 1/2 | J5452F, J5452FBL, J5454F, J5457F | 0.30 |



PEAR HEAD RATCHET REPAIR KITS

| Product # | Drive Size (in) | Ratchet # | Weight (lbs) |
|--------------------|-----------------|------------|--------------|
| J4749XLRK | 1/4 | J4749XL | 0.04 |
| J4749XLHSRK | 1/4 | J4749XLHS | 0.06 |
| J4749RK | 1/4 | J4749 | 0.04 |
| J4749HSRK | 1/4 | J4749HS | 0.04 |
| J6064RK | 3/8 | J5248S | 0.07 |
| J5249XLRK | 3/8 | J5249XL | 0.13 |
| J5249FWRK | 3/8 | J5249FW | 0.13 |
| J5249HSRK | 3/8 | J5249HS | 0.15 |
| J5249XLHSRK | 3/8 | J5249XLHS | 0.15 |
| J5449RK | 1/2 | J5449 | 0.38 |
| J5449UTRK | 1/2 | J5449UT | 0.38 |
| J5449XLRK | 1/2 | J5449XL | 0.23 |
| J5449-14RK | 1/2 | J5449-14BL | 0.37 |
| J5450FWRK | 1/2 | J5450FW | 0.26 |
| J5649FWRK | 3/4 | J5649FW | 1.00 |
| J5649RK | 3/4 | J5649 | 1.00 |



REVERSE CAM REPAIR KIT

| Product # | Drive Size (in) | Weight (lbs) |
|----------------|-----------------|--------------|
| J5649RC | 3/4 | 0.02 |



TORQUE MULTIPLIER SQUARE DRIVE REPLACEMENT KITS

- ▶ Proto® torque multipliers provide overload protection with replaceable output square drives that are designed to twist off at 3%-10% over maximum output capacity.



| Product # | Drive Size (in) | Torque Multiplier # | Weight (lbs) |
|----------------|-----------------|---------------------|--------------|
| J6212RD | 3/4 | J6212 | 0.20 |
| J6222RD | 1 | J6222 or J6234 | 0.53 |
| J6232RD | 1 | J6232 | 0.56 |
| J6242RD | 1-1/4 | J6242 | 1.55 |
| J6252RD | 1-1/2 | J6252 | 1.72 |



RATCHET HEAD REPAIR KITS - TORQUE WRENCH

- ▶ 1/4" to 1" ratchet wheels made from alloy steel for uncompromising strength and durability.
- ▶ Field repair your torque wrench ratchet head easily with the corresponding repair kit.



| Product # | Drive Size (in) | Torque Wrench # | Weight (lbs) |
|----------------|-----------------|--|--------------|
| J6062RK | 1/4 | J6062C, J6062CX, J6062CXCERT | 0.06 |
| J6064RK | 3/8 | J6064C, J6064CX, J6064CXCERT | 0.07 |
| J6006RK | 3/8 | J6006C, J6006CX, J6006CXCERT, J6006MC, J6006NMC, J6012C, J6066C, J6066CX, J6066CXCERT | 0.18 |
| J6014RK | 1/2 | J6014C, J6014CX, J6014CXCERT, J6014MC, J6014NMC, J6016C, J6016CX, J6016CXCERT, J6016MC, J6016NMC, J6068C, J6072C, J6072CX, J6072CXCERT | 0.37 |
| J6008RK | 1/2 | J6008C, J6008CX, J6008CXCERT | 0.19 |
| J6018RK | 3/4 | J6018AB, J6018CX, J6018CXCERT, J6020AB, J6020CX, J6020CXCERT, J6020NM | 1.36 |
| J6022RK | 1 | J6022B | 1.51 |



3/4" DRIVE HEX BIT REPAIR KITS

| Product # | Drive Size (in) | Hex Bit # | Weight (lbs) |
|---------------------|-----------------|------------|--------------|
| J075901RK | 3/4 | J075901 | 0.94 |
| J075903/4RK | 3/4 | J075903/4 | 0.41 |
| J075905/8RK | 3/4 | J075905/8 | 0.21 |
| J075907/8RK | 3/4 | J075907/8 | 0.62 |
| J075909/16RK | 3/4 | J075909/16 | 0.18 |

**CANNON PLUG PLIERS REPAIR KIT**

| Product # | Weight (lbs) |
|----------------|--------------|
| J253GRK | 0.01 |

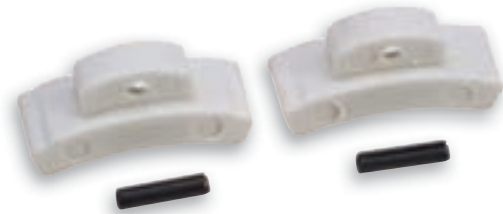
**UNIVERSAL CHAIN WRENCH REPAIR KIT**

- › Fits any shape pipe.
- › Chain capacity rating: 6,200 lbs

| Product # | Weight (lbs) |
|---------------|--------------|
| J801RK | 0.73 |



PIPE WRENCH REPLACEMENT PARTS

- › Replacement parts for heavy-duty pipe wrenches.

| Parts For | Handle, Heel Jaw, and Pin Assemble | Weight (lbs) | Hook Jaw | Weight (lbs) | Heel Jaw and Pin | Weight (lbs) | Knurl | Weight (lbs) | Coil and Flat Spring | Weight (lbs) |
|---------------|------------------------------------|--------------|----------|--------------|------------------|--------------|-------|--------------|----------------------|--------------|
| J806HD | J806H | 0.33 | J806B | 0.11 | J806C | 0.02 | J806D | 0.03 | J806E | 0.01 |
| J808HD | J808H | 0.61 | J808B | 0.23 | J808C | 0.04 | J808D | 0.03 | J808E | 0.01 |
| J810HD | J810H | 1.20 | J810B | 0.45 | J810C | 0.08 | J810D | 0.07 | J810E | 0.01 |
| J812HD | J812H | 1.97 | J812B | 0.68 | J812C | 0.15 | J812D | 0.09 | J812E | 0.02 |
| J814HD | J814H | 2.79 | J814B | 0.97 | J814C | 0.15 | J814D | 0.11 | J814E | 0.03 |
| J818HD | J818H | 4.09 | J818B | 1.57 | J818C | 0.23 | J818D | 0.18 | J818E | 0.04 |
| J824HD | J824H | 7.35 | J824B | 2.36 | J824C | 0.32 | J824D | 0.31 | J824E | 0.06 |
| J836HD | J836H | 14.40 | J836B | 4.37 | J836C | 0.58 | J836D | 0.47 | J836E | 0.07 |
| J848HD | – | – | J848B | 7.31 | J848C | 0.72 | J848D | 0.68 | J848E | 0.11 |
| J860HD | – | – | J860B | 12.50 | J860C | 1.50 | J860D | 0.85 | J860E | 0.08 |

| Parts For | Hook Jaw | Weight (lbs) | Heel Jaw | Weight (lbs) | Pin | Weight (lbs) | Spring | Weight (lbs) |
|---------------|----------|--------------|----------|--------------|---------|--------------|---------|--------------|
| J810PG | J810PGB | 0.60 | J810PGC | 0.31 | J810PGD | 0.04 | J810PGE | 0.01 |
| J814PG | J814PGB | 0.84 | J814PGC | 0.29 | J814PGD | 0.08 | J814PGE | 0.01 |

COMPRESSION GAUGE PARTS

| Product # | Overall Length (in) | Use With | Weight (lbs) |
|------------------|---------------------|---------------|--------------|
| JCT61 | 3-1/2 | JCT21, JCTR10 | 0.39 |
| JCT21RK | 7-3/16 | JCT21 | 0.29 |
| JCTR10-7A | 7/16 | JCTR10 | 0.01 |
| JCTR10RK | 22-5/16 | JCTR10 | 0.80 |
| JCTR20-4C | 2-5/16 | JCTR20 | 0.35 |
| JCTR20RK | 9-1/2 | JCTR20 | 0.48 |

